



Stylish Domes and Room in Room Structures for events, congresses and offices



Minimum assembly
and disassembly time



Rooms for 1 to 1000+ people



Optimal acoustics
& sound insulation



No fan noise



Sustainable and circular

PANORAMA DOME 14



General

The Panorama Dome is an inflatable workshop Dome or room and is a round structure with an open roof. This popular inflatable Dome is often used as a subspace or workshop space at trade fairs and conferences. The open roof creates a sense of space inside the dome, while privacy, acoustics and soundproofing are guaranteed. The Panorama Dome can be used, for example, as a workshop space, break-out space at conferences or trade fairs, or as a presentation space.



Measurements

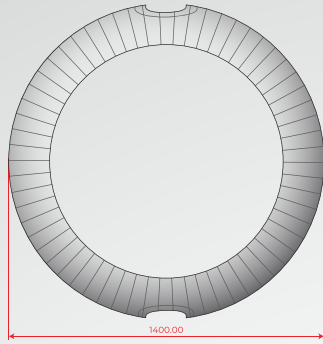

PRESPECTIVE

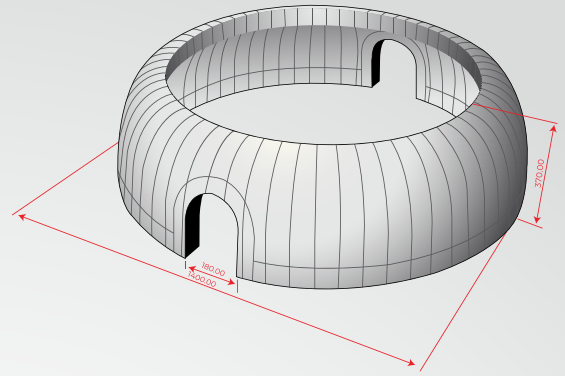

TOP

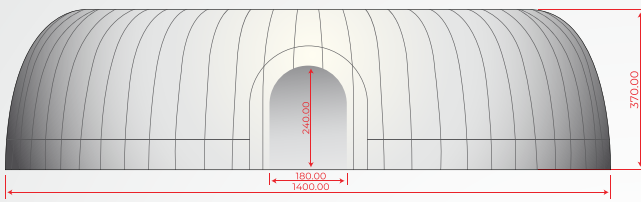

FRONT

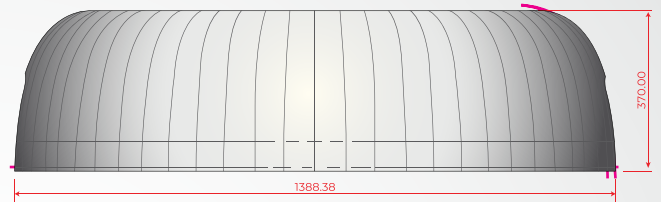

RIGHT



Diameter
(outer / inner)

14 m
13 m

Height
(outer / inner)

3.7 m
3.7 m

Surface
(inner)

125m²

Max chairs

120-140

Color

white

LED

RGB bars
of 1m

Weight

110 kg

Power

220v
1130w no LED
1830w With LED

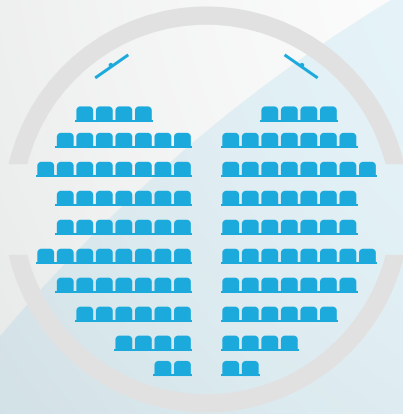

Theatre
~120 chairs

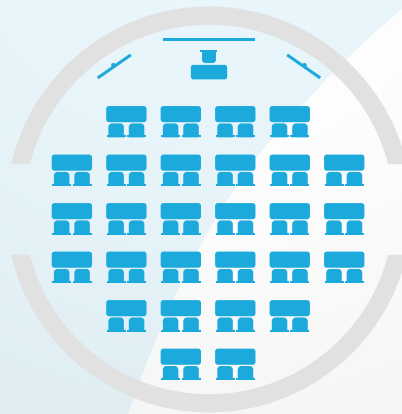

Classroom
~56 chairs

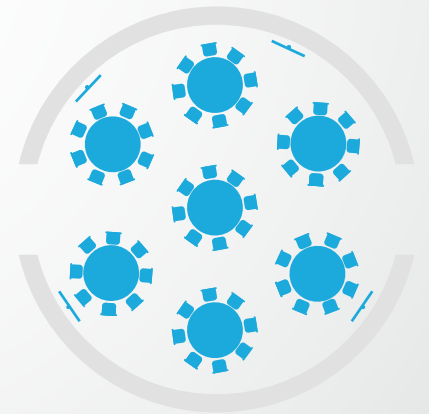

Banquet
~48 chairs

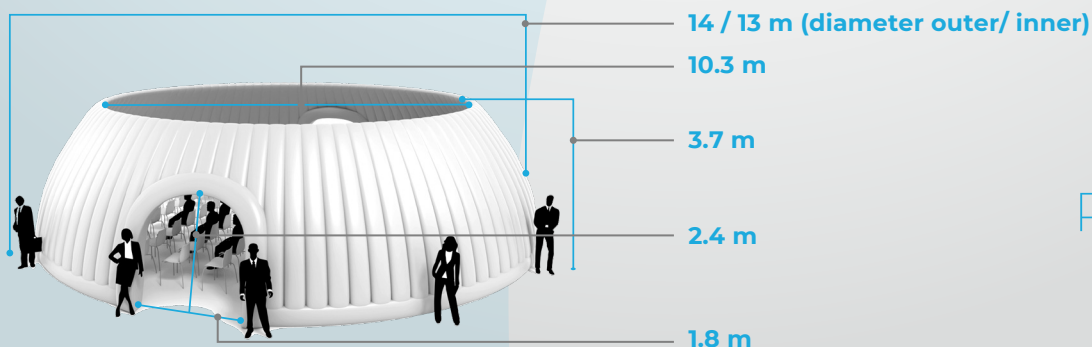

PANORAMA
DOME
14

Product Enhancement

ACOUSTICS AND QUIET AIRFLOW

This Panorama is optimized for acoustic properties, making them ideal for workshops and presentations or acoustic partitions, for example. In addition, this structure is equipped with an isolated blower system that is not audible.

SUSTAINABILITY AND CIRCULARITY

With QuickSpace products, you don't create waste at your event. Our products are cleaned in an environmentally friendly way after use, making them new-worthy at every event. At the end of life, our products are processed into other products such as storage bags, contributing to a circular economy.

BRANDING

On request, this structure can be branded with your own branding, for example by theme colors, projection of logos or texts, or by means of TV screens or banners.

LED LIGHTING

This structure can be illuminated in any color using LED modules, creating a unique ambiance. This can be set both statically and dynamically.

QUICK INSTALLATION AND DISMANTLING

One of the benefits of QuickSpace products is the quick installation and dismantling. Hence, it is possible to install the structures at your convenient times, saving you costs and time. Our experienced teams will take care of the installation, disassembly and, if necessary, design of your event.

FIRE SAFETY CERTIFICATES

All our structures have the most important fire safety certificates such as German B1, France M1 and American NFPA 701



Phone:

+31 6 41 67 57 07
+31 6 12 98 62 31

E-mail:

info@quickspace.eu

QuickSpace B.V.

Lonnekerweg 298
7532 RD Enschede
Nederland



facebook.com/quickspacehomes



instagram.com/quickspace_eu

Contact

Phone:

+49 176 55071328

E-mail:

info@quickspace.de

QuickSpace Zeltsysteme GmbH

Buterlandstr. 89
D-48599 Gronau
Deutschland
USt-ID: DE 322458558

quickspace.eu