



Stylish Domes and Room in Room Structures for events, congresses and offices



Minimum assembly
and disassembly time



Rooms for 1 to 1000+ people



Optimal acoustics
& sound insulation



No fan noise



Sustainable and circular

CURVED WALL 8



General

Inflatable Curved Walls are ideal for use at fairs and conferences, for example, where they can serve as a dividing wall. These inflatable curved walls can also be used to create separate spaces, to form walkways or to create sight lines. QuickSpace Curved Walls are modular so that they can be linked together, creating theoretically infinite lengths and shapes.



Measurements

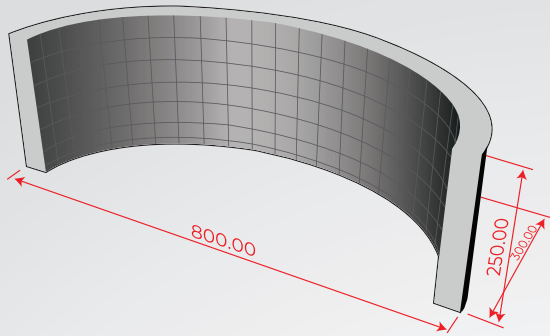

PRESPECTIVE

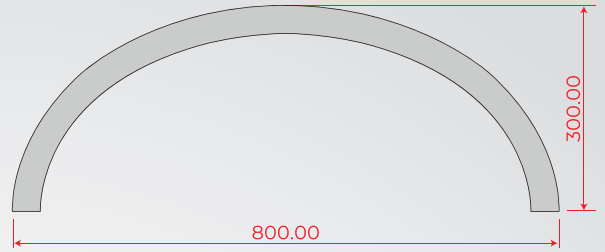

TOP

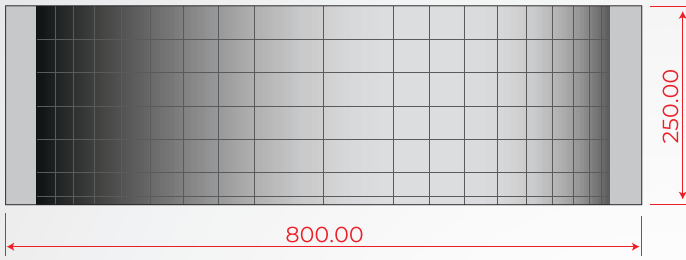

FRONT

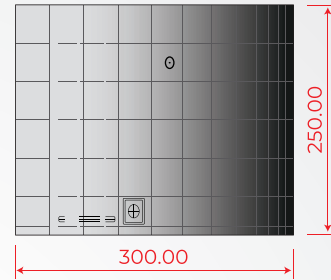

RIGHT



Length
8 m



Width
3 m



Height
2.5 m



Surface
N/A



Max chairs
26 - 30



Color
white



LED
RGB bars
of 1m



Weight
16 kg



Power
220v
250w no LED
450w With LED

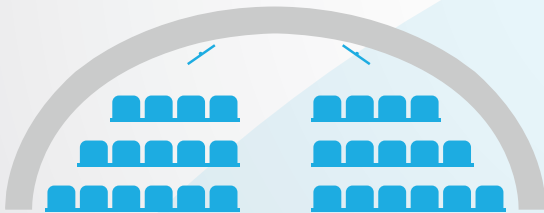

Theatre
~30 chairs

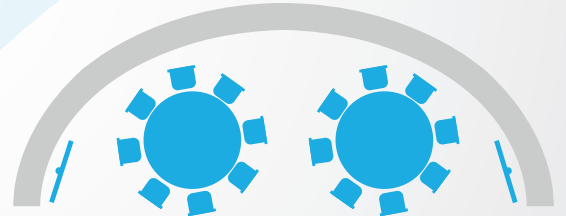

Banquet
~16 chairs

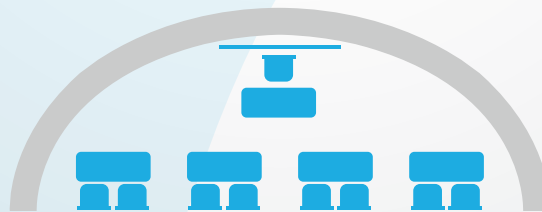

Classroom
~8 chairs

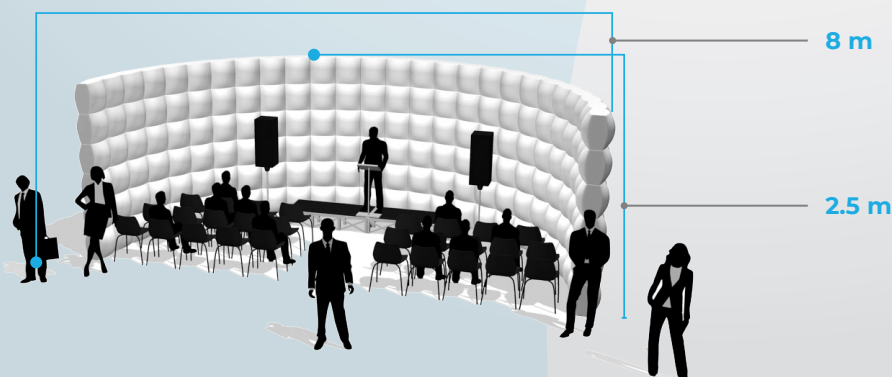

CURVED
WALL
8

Product Enhancement

ACOUSTICS AND QUIET AIRFLOW

This Curved Wall is optimized for acoustic properties, making them ideal for workshops and presentations or acoustic partitions, for example. In addition, this structure is equipped with an isolated blower system that is not audible.

LED LIGHTING

This structure can be illuminated in any color using LED modules, creating a unique ambiance. This can be set both statically and dynamically.

BRANDING

On request, this structure can be branded with your own branding, for example by theme colors, projection of logos or texts, or by means of TV screens or banners.

TRUSS SYSTEM

This wall structure is fitted with a non-visible truss system, giving it extra stability.

SUSTAINABILITY AND CIRCULARITY

With QuickSpace products, you don't create waste at your event. Our products are cleaned in an environmentally friendly way after use, making them new-worthy at every event. At the end of life, our products are processed into other products such as storage bags, contributing to a circular economy.

QUICK INSTALLATION AND DISMANTLING

One of the benefits of QuickSpace products is the quick installation and dismantling. Hence, it is possible to install the structures at your convenient times, saving you costs and time. Our experienced teams will take care of the installation, disassembly and, if necessary, design of your event.

FIRE SAFETY CERTIFICATES

All our structures have the most important fire safety certificates such as German B1, France M1 and American NFPA 701



Phone:

+31 6 41 67 57 07
+31 6 12 98 62 31

E-mail:

info@quickspace.eu

QuickSpace B.V.

Lonnekerweg 298
7532 RD Enschede
Nederland



facebook.com/quickspacehomes



instagram.com/quickspace_eu

Contact

Phone:

+49 176 55071328

E-mail:

info@quickspace.de

QuickSpace Zeltsysteme GmbH

Buterlandstr. 89
D-48599 Gronau
Deutschland
USt-ID: DE 322458558

quickspace.eu