

1. Unboxing

You can watch the video version of this chapter [here](#).

Woo! Your new MIDI controller has arrived!

In the box you should find:

- 1x BRIDGE4 MIDI controller (obviously)
- 1x 2 metre USB type A to type C cable (black)
- 4x Self-adhesive rubber feet
- 1x 'Getting Started' card
- 1x Flexiport Warning card



The box and getting started cards are completely recyclable, so please make sure to dispose of them responsibly if you don't keep them.

Now, let's stop drooling and plug it in!

2. Device Layout

Your BRIDGE4 is a masterpiece of design and engineering (just ask us!). Here is an overview of the device.

The features of each input/output are detailed in “**4. Connectors**”



From left to right:

- **USB (type-C)**
 - Power
 - USB MIDI In/Out
- **TRS Flexiports x2 (6.35mm / 1/4" TRS)**
 - MIDI Out
 - Expression In
 - Ext Switch In
 - Switch Out
 - Tap Tempo Out
 - Sync Pulse Out
 - Device Link
- **TRS MIDI Out (3.5mm TRS)**
 - Dedicated MIDI Output (only)
- **TRS MIDI In (3.5mm TRS)**
 - Dedicated MIDI Input (only)
- **9v DC (2.1mm centre-negative)**
 - Power



- **Footswitches**

- Four silent footswitches are the main interface on the BRIDGE4. Rated for over 100,000 presses each, they are able to send different MIDI message stacks for different press types (Toggle On, Toggle Off, Press, Release, Double Press, Hold, Hold Release).

Each switch is able to send 176 MIDI messages per bank:

- Toggle On: 48
- Toggle Off: 48
- Press: 16
- Release: 16
- Hold: 16
- Hold Release: 16
- Double Press: 16

- **OLED Display**

- A large graphical display allows us to display symbols and icons to make the user interface easier to use.

The beauty of an OLED is the crisp, high-contrast display. Easily readable from a distance with no need for an annoying backlight.

By default, the OLED shows the bank name in the centre, and each switch label is set to "FS 'x". Switch labels and bank names are editable through the onboard menus and the app.

- **RGB LEDs**

- Each switch is paired with a curved light pipe that houses 2 independent RGB LEDs. This means you can choose from millions of colours per switch and combine different LED states/colours to create your own custom interface.

Note: Changing colours is possible in the device menus, but is limited to preset colours. For free choice, use our app.

3. Power & Navigation

You can watch the video version of this chapter [here](#).

You can power your BRIDGE4 with either a USB cable, or a centre-negative 9v DC jack (2.1mm) commonly used for guitar pedals.

The BRIDGE4 uses smart power switching so you can have both plugged in at once, and if you need to remove one or the other, the unit will seamlessly switch power sources without shutting down or restarting.



If you're using a 9v DC power supply, please make sure it is able to supply the required 200mA.

Basic Navigation

Bank Up & Bank Down

As indicated by the arrows on the screen, pressing switches 3 & 4 at the same time will advance to the next bank (Bank Up) and pressing switches 1 & 2 at the same time will go to the previous bank (Bank Down). This is indicated by the two arrows displayed on the screen (visible on below diagram)

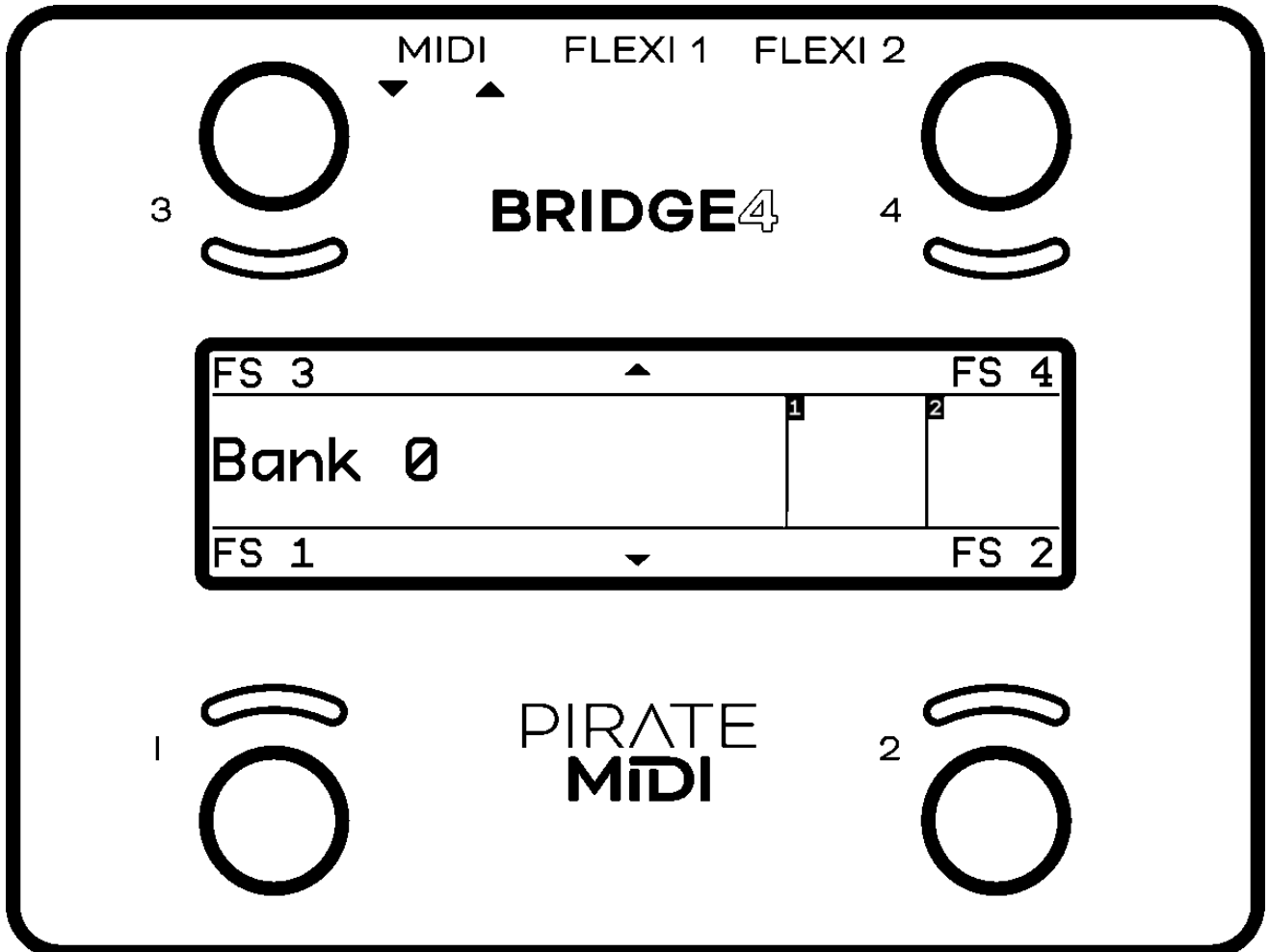

There are 100 banks (0-99). Banking up from bank 99 will return you to bank 0. Banking down from bank 0 will send you to bank 99.

Opening the Menu

To enter the menu, press and hold down switches 1 & 3 simultaneously (as pictured below). You will know you've entered the menu when the screen layout changes.

Press switch 1 or switch 2 to navigate the menu (note the arrows on screen).

Press switch 1 & 2 to select or set (like an 'enter' or 'return' key on a computer).

Press switch 3 to 'go back' to the previous menu screen.

Hold switch 3 on any menu screen to completely exit the menu.

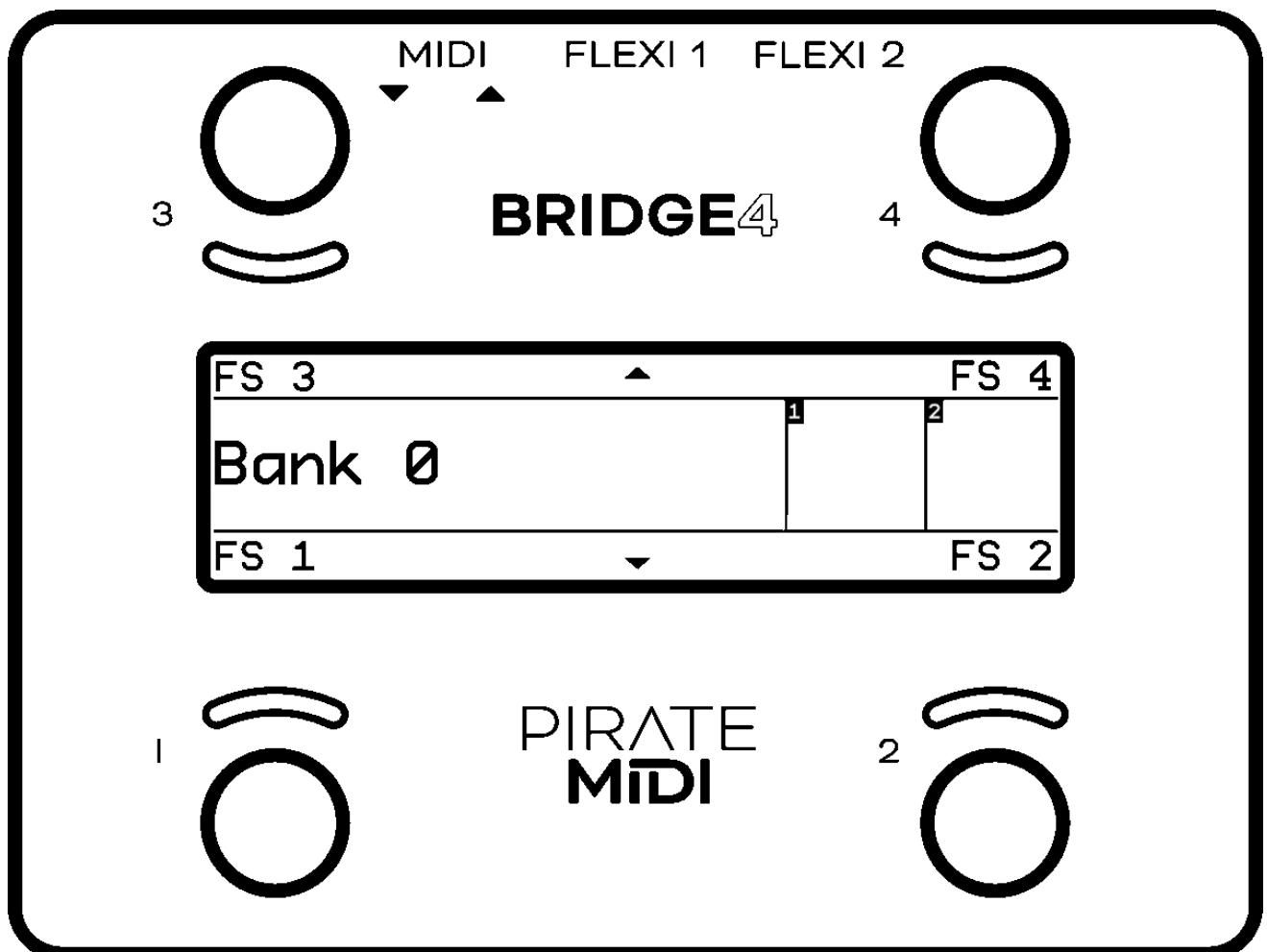

Second-Screen Settings

When editing parameters like MIDI message details, LFO settings etc. there is often a second (or third) screen of settings. To access these pages, use the left and right arrows on switch 4 & 3+4 to navigate across the screen.

You can see an example of a screen with left and right arrows below. The active area ("type") is highlighted with a box. This highlight box will move as you navigate with switch 4 & 3+4.

These pages are "circular" and navigating across in one direction will eventually bring you back to the place you started.

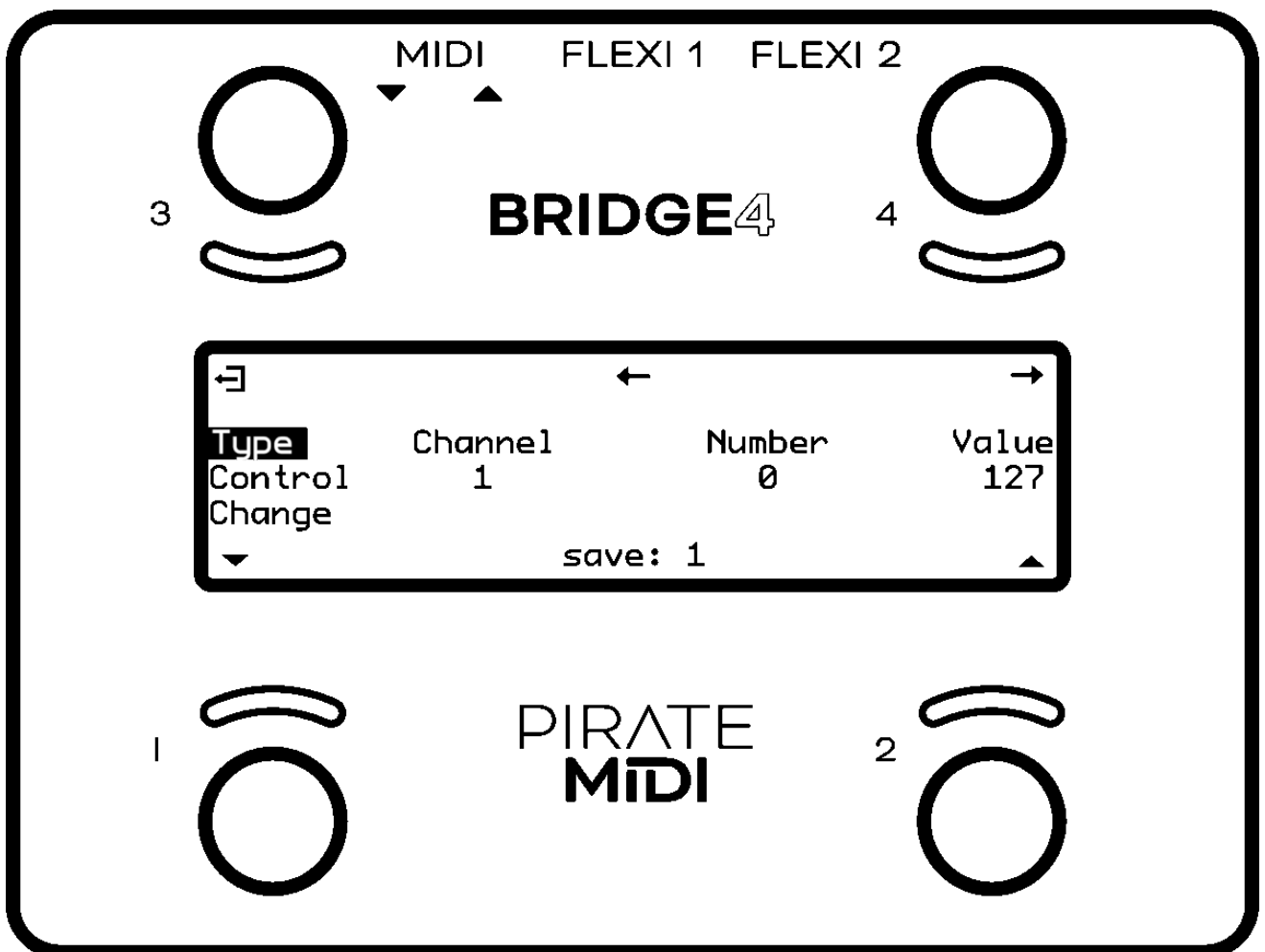

That's the end of the basic navigation instructions. After this you should be able to figure out how to navigate all the menus and settings. You can watch the video linked at the top of this page if you'd like to cover the content again in a different format.

4.1 Overview of Connectors



From left to right:

- **USB (type-C)**
 - The BRIDGE4 can be powered by USB, and is also a class-compliant USB MIDI device. This means it will be recognised as a MIDI device without any drivers. Use it with your DAW, plugins, or music apps.
- **TRS Flexiport 2**
 - A ¼" (6.35mm) TRS jack with 8 modes (and counting):
 - MIDI Out
(can power [CME WIDI devices](#))
 - Exp In
(Single Expression Pedal Input)

- Exp-Doubler In
(Enables two expression pedal inputs per Flexiport with our [Exp-Doubler](#) device)
 - Ext Switch
(1, 2, or 3 switches supported)
 - Switch Out
(Send TRS switch emulation to non-MIDI devices with an external control jack - Helix, Boss, etc)
 - Tap Tempo Out
(MIDI Clock as switch output)
 - Sync Pulse Out
(Square wave output for syncing non-MIDI devices to MIDI Clock such as Teenage Engineering Pocket Operator series)
 - Device Link
(connect multiple PIRATE MIDI devices together)
- **TRS Flexiport 1**
 - A ¼" (6.35mm) TRS jack with 8 modes (and counting):
 - MIDI Out
(can power [CME WIDI devices](#))
 - Exp In
(Single Expression Pedal Input)
 - Exp-Doubler In
(Enables two expression pedal inputs per Flexiport with our [Exp-Doubler](#) device)
 - Ext Switch
(1, 2, or 3 switches supported)

- Switch Out
(Send TRS switch emulation to non-MIDI devices with an external control jack - Helix, Boss, etc)
 - Tap Tempo Out
(MIDI Clock as switch output)
 - Sync Pulse Out
(Square wave output for syncing non-MIDI devices to MIDI Clock such as Teenage Engineering Pocket Operator series)
 - Device Link
(connect multiple PIRATE MIDI devices together)
- **TRS MIDI Out (3.5mm)**
 - A 3.5mm TRS Jack designated as a dedicated MIDI output. This output conforms to the [MIDI Specification](#) and can power [CME WIDI products](#).
 - **TRS MIDI In (3.5mm)**
 - A 3.5mm TRS Jack designated as a dedicated MIDI input. This MIDI input conforms to the [MIDI Specification](#).
 - **9v DC (centre-negative)**
 - A 2.1mm centre-negative barrel jack (common with standard guitar pedal power supplies). Requires 200mA.

4.2 Flexiports

The extreme flexibility of the BRIDGE4 is due partly to the two Flexiports we've included. The Flexiport is a multi-function TRS port that we've designed (and named) to give you a truly flexible experience with our devices.

Flexiports will be included in most PIRATE MIDI devices and will offer the same functionality across all devices so if you see the name Flexiport you know what it does.



Flexiport Modes

Each Flexiport on the BRIDGE6 is a 6.35mm (¼") TRS Jack. They have 8 modes (and counting) that are assignable in the Menu under "Menu > Global > Flexiports > Flexiport 'x' > Mode"

1. MIDI Out

(can power [CME WIDI devices](#))

2. Exp In

(Single TRS expression pedal input)

3. Exp-Doubler In

(Enables two expression pedal inputs per Flexiport with our [Exp-Doubler](#) device)

4. Tap Tempo Out

(MIDI Clock as switch output)

5. External Switch

(1, 2, or 3 switches supported)

6. Switch Out

(Send TRS switch emulation to non-MIDI devices)

7. Sync Pulse Out

(Send MIDI clock as a square wave to sync non-MIDI devices)

8. Device Link

(connect multiple PIRATE MIDI devices together)



WARNING: Flexiports offer many operating modes. Not all of these modes are compatible with external devices.

In particular, the Switch Out mode allows a Flexiport to emulate a TRS switch output. This is designed to control devices that have an auxiliary switch input, or tap tempo footswitch jack.

Many devices use larger operating voltage and/or currents that the Flexiport is able to handle. Please go to piratemidi.com/compatibility for a list of devices we have checked for compatibility. Please contact us to see if your device may be compatible with this mode.

A Flexiport can also be damaged when using an incorrect mode with an external device attached. Make sure that you have enabled the correct Flexiport mode **BEFORE** connecting an external device.

Ignoring these warnings may void your warranty. Please make sure to contact us if you're unsure. Email support@piratemidi.com

MIDI Out

When set to "MIDI Out" mode, the Flexiport is a dedicated MIDI TRS Output. It can be put in TRS A or TRS B mode in firmware v1.1.0 in the Global settings menu:

""Menu > Global > Flexiports > Flexiport 'x' > MIDI TRS Type ""

TRS A is the standard MIDI [specification for TRS MIDI](#). It use the 'Tip' to send MIDI. However, because MIDI over TRS was introduced before the specification was decided, there are some brands (Arturia, Novation, Chase Bliss Audio and others) that send on the 'Ring.' This is called TRS B.

Cables can easily be found online that swap TRS A to TRS B, but if you don't have any on hand, or it's not convenient, then switching in the BRIDGE6 firmware is quick and easy. Plus it doesn't cost anything!

Once the Flexiport is in MIDI Out mode, any messages that have their MIDI set to be output to that Flexiport will be transmitted out that Flexiport when the messages are triggered.

Expression Pedal In

When set to "Exp In" mode, the Flexiport will receive analog CV or expression pedal input for easy conversion to MIDI. Set the Flexiport to "Exp In" mode in the Global settings menu:

"Menu > Global > Flexiports > Flexiport 'x' > Mode > Exp In"

Please note that this is designed to work with TRS expression pedals only. To use a volume pedal, you will need a [TRS Y-Splitter](#). TS Expression pedals will not work.

Calibration

Expression pedals will often not register their full range on different devices they connect to. This is why a calibration feature is necessary. Calibrating your expression pedal will make sure that toe-down is equal to the maximum MIDI value (127) and heel-down is equal to the minimum value (0).

Calibrate your expression pedal in the menu:

"Menu > Global > Global Exp Pedals > Exp 'xx' > Calibrate"

Exp-Doubler

When set to “Exp-Doubler” mode, usage is the same as “Exp In” including calibration etc. but this mode can only be used with the [PIRATE MIDI Exp-Doubler](#).

“Menu > Global > Flexiports > Flexiport ‘x’ > Mode > Exp-Doubler”

An expression pedal usually works with three contacts: Tip, Ring, and Sleeve. The Tip supplies power, the Sleeve is connected to ground, and the Ring transmits the position of the pedal. Our [Exp-Doubler](#) supplies power to the Tip of your expression pedals which leaves an extra slot on the Flexiport for receiving the pedal position. Across two flexiports this means **up to 4 expression pedals can be used!** Two per Flexiport.

This is why Expression pedals are labelled as 1A and 1B, 2A and 2B.

Ext Switch In

When set to “Ext Switch” mode, the Flexiport will receive auxiliary switch input for extra footswitch controls. Set the Flexiport to “Ext Switch” mode in the Global settings menu:

“Menu > Global > Flexiports > Flexiport ‘x’ > Mode > Ext Switch”

Single, double or triple auxiliary switches will work in this mode. Plug your aux switch into your Flexiport and then assign it a function or MIDI command:

“ Menu > Global > Flexiports > Flexiport ‘x’ > Ext Switch Config “

Using the menu you will now be able to assign 3 auxiliary switches (Tip, Ring, Tip+Ring) to three different functions.

Currently the choice is as follows:

- None
- Bank Up
- Bank Down
- FS1

- FS2
- FS3
- FS4
- FS5
- FS6

We plan to expand the features and capabilities of external switches in firmware v1.1.0

Switch Out

When set to "Switch Out" mode, the Flexiport will act like an analog switch. This can be used to control functions on non-MIDI pedals that have a switch input like a tap tempo footswitch in or some other function. Set the Flexiport to "Switch Out" mode in the Global settings menu:

"Menu > Global > Flexiports > Flexiport 'x' > Mode > Switch Out"

Some devices that have a footswitch input are: [BOSS MS-3](#), [MXR Carbon Copy Deluxe](#), [Line6 HX Stomp](#), BOSS DD-20 Gigadelay.

Assigning 'Switch Out' Actions to a Footswitch

Once you have set the Flexiport mode, you can set any of the BRIDGE6 footswitches to activate a Switch Out message when pressed. You can send a Tip, Ring, or Tip+Ring message of your choosing for any switch on any bank with any press type.

To set a footswitch TRS Out message:

First, select the bank you wish to program the action to.

Then, enter the menu:

" Menu > Switches > Switch 'x' > TRS Out > *Press Type* > Flexiport 'x' > Switch Type (Tip, Ring, Tip+Ring) "

Now, when you press that switch, on that bank, for the chosen press type (toggle on, toggle off, hold etc.) your chosen TRS switch type (Tip, Ring, or Tip+Ring) will be sent out the chosen Flexiport.

You can only perform one 'Switch Out' action per press type, per Flexiport.

All switch press types are, by default, set to not open the tip and ring. This means that assigning a "press" action to "tip" will result in a press and release closing and opening the circuit, because releasing the switch will trigger the Switch Out to "open" again.

Tap Tempo Output

When set to "Tap Tempo Output" mode, the Flexiport is a dedicated analog TRS output which sends switch impulses synced to the chosen MIDI clock (A or B). It can be put in Clock A or Clock B mode in the Global settings menu:

"Menu > Global > Flexiports > Flexiport 'x' > Mode > Tap Tempo Out > MIDI Clock 'x' "

Now, connect a TRS cable from the Flexiport to the device you wish to send the tap tempo to, and you should see the tap tempo changing on your non-MIDI device.

For an example of this using the BOSS DD-20 Gigadelay, [see this video](#).

Other Devices that accept Tap Tempo Out include: [MXR Carbon Copy Deluxe](#), [BOSS DD-20 Gigadelay](#)

Device Link

Device Link is not yet fully featured or implemented. Please wait for an imminent firmware update for more features.

When set to "Device Link" mode, the Flexiport acts as a high-speed communication port to link two PIRATE MIDI devices for transfer of MIDI messages and other commands. Activate Device Link mode in the menu:

" Menu > Global > Flexiports > Flexiport 'x' > Mode > Device Link "

Device Link is able to sync bank changes, bank names, LED brightness, and also acts as a high-speed MIDI link between the two devices for more MIDI ins and outs.

Setting the Master/Slave Roles

Go to “ Menu > Global > Device Link > Role “
to choose which device will broadcast it’s bank name and act as the master device

Choosing what to sync

Go to “ Menu > Global > Device Link > Control “
to choose what settings will be synchronised from the master device.

4.3 MIDI In/Out/Thru

Your BRIDGE4 has dedicated MIDI In and MIDI Out 3.5mm TRS jacks.

MIDI Out

The MIDI Out connector on the BRIDGE4 is a MIDI out only. It cannot be changed to have any other features or become a MIDI in.

It conforms to the [MIDI specification](#) and is capable of powering [CME](#) WIDI devices like the [WIDI Master](#) or the [WIDI Jack](#).

To send a MIDI message out of this jack, make sure that “TRS” is turned to “on” on the second-screen settings of your chosen MIDI message.

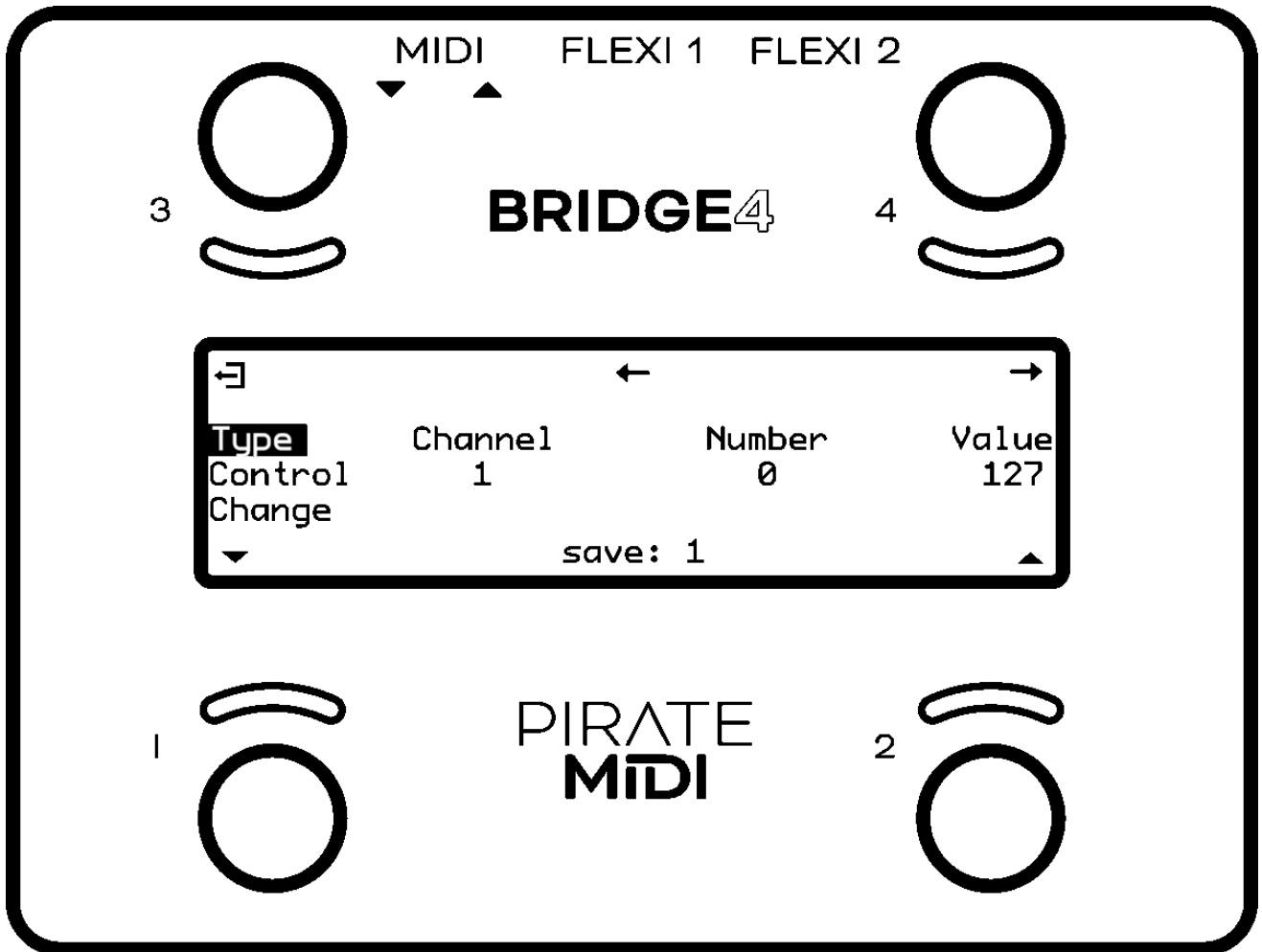

MIDI In

The dedicated MIDI In on the BRIDGE4 is a 3.5mm TRS Jack. Like the MIDI Out, it is not able to be changed to another function. It is a permanent MIDI In. It accepts any kind of MIDI message, and depending on the 'Thru' routing (detailed in the next section) those messages can be directly sent to any of the available MIDI outs.

This MIDI In complies with the [MIDI Specification for TRS MIDI](#) (type A).

External MIDI Control

Using the MIDI commands detailed in the "MIDI Implementation" chapter at the end of this manual, you can send MIDI commands from another device to the BRIDGE6 via the MIDI In (or USB) to control the device.

MIDI Thru

There is no dedicated MIDI Thru jack on the BRIDGE6, however the digital MIDI Thru routing is very flexible. MIDI Thru can be sent to any of the 4 available MIDI Outs.

To set the MIDI Thru routing go to:

“ Menu > Global > MIDI > Thru Routing > TRS In *or* USB In ”

This menu allows you to choose which MIDI Outs (Flexi 1, Flexi 2, TRS, USB) the MIDI messages received on the chosen input (USB or TRS In) will be sent to.

For example, if you choose to turn on MIDI Thru routing from the USB In to the TRS out, any message received on the USB In will be sent to the 3.5mm TRS MIDI out. But it will not be sent to the USB out or the Flexiport unless they are also set to ‘on’ in the Thru routing settings.

4.4 USB

Your BRIDGE4 is a class-compliant USB MIDI device. This means you can plug it into any kind of USB host (Windows, Mac OS, iOS, Android) and it will automatically be recognised as a MIDI device to control or receive messages from any DAW, app or plugin.

USB (type-C)

USB MIDI requires a USB host device. A host device can be a computer, tablet, phone, or some kind of USB MIDI host box designed to link a pedal with USB directly to a MIDI controller without needing a computer-like device.

The BRIDGE4 does not offer itself as a USB host and therefore cannot be directly linked from USB to USB on pedals such as the Zoom multistomp series.

A USB host device like the CME WIDI UHOST will be a great addition to your BRIDGE4. Plug it into your USB port and go wireless! It also means that as a USB host

device, you can connect the WIDI UHOST to a WIDI Jack or similar and use the USB MIDI in/out as another general MIDI in/out to the device the WIDI Jack is plugged into.

The USB port receives power as well as USB MIDI.

Note: iPads/iPhones/Android etc. do not provide enough power from their USB port to power the BRIDGE4. You will need to power it via a powered USB hub or the DC jack.

5.1 Command Possibilities

You can program your BRIDGE4 with the onboard menus or the desktop app. We've made both methods as straightforward as possible so you can quickly get up and running. Here's an overview of what you can do when programming your BRIDGE4. Step-by-step instructions for these methods will be covered in later sections.

Message Types

Note On, Note Off, Poly Pressure (Aftertouch), Control Change (CC), Program Change (PC), Channel Pressure, and Pitch Bend messages can be set as the message type for any MIDI message on the BRIDGE4.

In addition to the types above, real-time messages such as MIDI clock, start & stop messages can be sent when a footswitch is set to "MIDI Clock" mode.

MIDI thru functions (covered in 4.3) will pass through any and all valid MIDI data, even if it happens to be a data type that the BRIDGE4 does not yet support.

Other Message Types

Along with MIDI messages, the message type can also be set to **Delay**.

This will allow you to insert a pause in your message stack in case the hardware receiving the messages takes extra time to process the messages or is easily overloaded.

Each Delay message can be set between XX and XX seconds in XX second increments.

This will be implemented in v1.1.0

Footswitch Modes

Each footswitch has 4 possible modes which are set at the Global level in:

“Menu > Global > Switches > FS‘x’ > Mode”

1. Toggle

This is the default switch mode. In this mode there are 7 different switch press types: **Toggle On, Toggle Off, Press, Release, Hold, Hold Release, and Double Press.**

When setting MIDI messages to these stacks, these are the current limits:

- Toggle On: 48
- Toggle Off: 48
- Press: 16
- Release: 16
- Hold: 16
- Hold Release: 16
- Double Press: 16

Total: 176

2. Tap Tempo

This sets a switch to be the main control for your choice of MIDI clock (A or B). In this mode, the switch label will show the Name (A or B) and the current tempo.

Tapping the footswitch will act like a tap tempo switch - changing the tempo in time with your taps. The primary LED (left) will flash to show the current tempo. The colour of the LED can be customised.

Holding down the footswitch will start or stop the MIDI clock. The secondary LED (right) will be lit or unlit to show whether the clock is running (LED on) or stopped (LED off).

3. Sequential

To be implemented in firmware v1.1.0

This mode will activate each message in the XXX stack individually, one at a time, when you press the footswitch. When you reach the last message, the next press will start the sequence again.

You will also be able to skip every second or 3rd message in the stack if you like. There will also be a reverse function, advance to the last message, and then go backwards up the sequence instead of circular.

Example:

In a message stack consisting of 3 messages, message 1 will be sent on the first press, message 2 will be sent on second press, message 3 will be sent on third press, and then message 1 will be sent on the fourth press - starting the sequence over again.

4. Momentary

This mode will change the footswitch action from toggle to momentary. This means the toggle on/off message stacks are deactivated, and the press, release, hold, and hold release stacks continue to function.

The primary LED will light when the switch is pressed, and will be off when not pressed.

This mode is useful for loopers, sustain, sending midi notes as chords, or any MIDI control that requires a momentary action.

When the switch is in momentary mode, LFO mode is also momentary. This can be used for controlling ramping/rises using the LFO.

Note: All message stacks will still be visible when editing MIDI messages, but the footswitch mode will determine which stacks are able to be edited.

Expand & Improve Your MIDI Routing

Each message can be individually tailored to go to any combination of the MIDI outputs available. When creating a message, turn the desired MIDI output/s (USB, DIN, Flexi 1, Flexi 2) 'On' or 'Off' to create different streams of MIDI messages from one switch press.

Example: In my 'Toggle On' stack of 48 MIDI messages I can output the first 16 messages from Flexi 1, the second 16 from Flexi 2, and the third 16 from the DIN5 MIDI out. By using all 16 MIDI channels on each output (message 1/channel 1, message 2/channel 2) this will result in 48 different devices able to be MIDI controlled by a single footswitch press with no conflicting MIDI channels.

Tip: you could add a fourth 'stream' of 16 MIDI messages with the USB MIDI out - this could be with a CME UHOST, or directly to software of some kind.

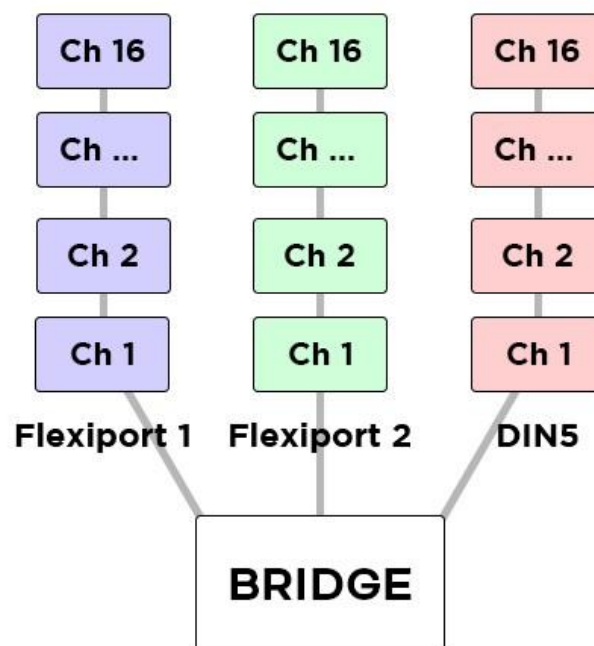

LFOs

Low Frequency Oscillators are not just for sound waves. With MIDI messages, we can oscillate the value data at low frequencies to modulate the MIDI data automatically and create 'moving' MIDI messages.

For example, a TC Electronics Plethora X5 has 5 knobs which are also controllable with MIDI CCs. By applying the LFO to one of those MIDI CCs, the BRIDGE6 can continually (and automatically) 'move' that knob.

The BRIDGE6 LFOs can be activated by 'hold' (only oscillate while the switch is being actively held down) or toggle (start oscillating on first press, stop oscillating on second press). The LFO will oscillate all possible MIDI messages that are in the chosen MIDI message stack.

See 5.2.1 to learn how to edit and view message stacks

Up to two switches per bank can have the LFO enabled.

The LFOs can be linked to MIDI clock A, MIDI clock B, or set with an independent frequency from 0.1hz to 10hz. Min/Max value limits can be set to limit the range of oscillation, and the waveform can be changed between sine, triangle, saw, ramp, square, and random.

Adjust the steps to change the resolution of the modulation, and choose whether to reset the waveform after each stop, or pick up where the wave was paused.

With six LFOs running on a bank and flexible MIDI routing, you can oscillate nearly 100 MIDI messages on each of the 100 banks! But you will have to be careful of the limitations of MIDI itself. Being such an old protocol, it takes approximately 1ms per MIDI message and can become quickly overloaded with LFO data.

If you are experiencing stuttering, try increasing the step size of the LFO and trying again.

Expression Pedals

With each Flexiport able to take an expression pedal input, or an [Exp-Doubler](#) input, you can do a lot with expression pedals on a BRIDGE6!

Each expression pedal can control a stack of bank messages and a stack of global messages. Each stack of 16 expression messages means you can control 32 messages per expression pedal.

Each individual message can be routed to any selection (or all) of the available MIDI outputs, and can be set with min/max limits and linear, log, or anti-log interpolation curve. If you like, you can also reverse the sweep so that the lowest value will be sent at the toe-down position and the highest value at the heel-down position.

As an example, you could have an expression pedal that controls a global CC7 (volume) message, and another expression pedal that controls the tremolo depth of another effect, but is limited to a range of 40%-70%. This same expression pedals could simultaneously modulate reverb size, time, and predelay, and perhaps also link to a low pass filter on an EQ effect.

For a truly 'experimental' sound, try linking 16 different parameters to one expression pedal, all with different min/max limits and sweep curves!

External Footswitches

An external switch, connected to a Flexiport, can have up to 3 switches using a TRS cable. These switches can be set to control bank up/down commands, or externally trigger one of the onboard switches.

Device Link

Connect two or more PIRATE MIDI devices via Flexiport (in Device Link mode) to enable high-speed MIDI input/output sharing, bank change sync, bank name sync, UI settings sync, and other features to come!

Want a MIDI controller with 10 switches? No problem, connect a BRIDGE6 and a BRIDGE4 with a TRS cable and away you go.

Device Link automatically detects what devices are connected and what their features are so you get an easy, flexible setup no matter what your combination of devices may be.

5.2.1 Message Stacks

Setting MIDI Messages Onboard

You can add MIDI messages for switch presses (per bank), expression pedals (per bank and global) but the method is essentially the same for each, you just find them in different places in the menu.

1. Footswitches

Viewing Messages on Footswitches

Enter the Menu by holding switch 1 & 3 simultaneously. Navigate to:

“ Menu > Switches > Switch ‘x’ > Messages > ‘press type’ ”

If the message stack is empty you will see the following screen

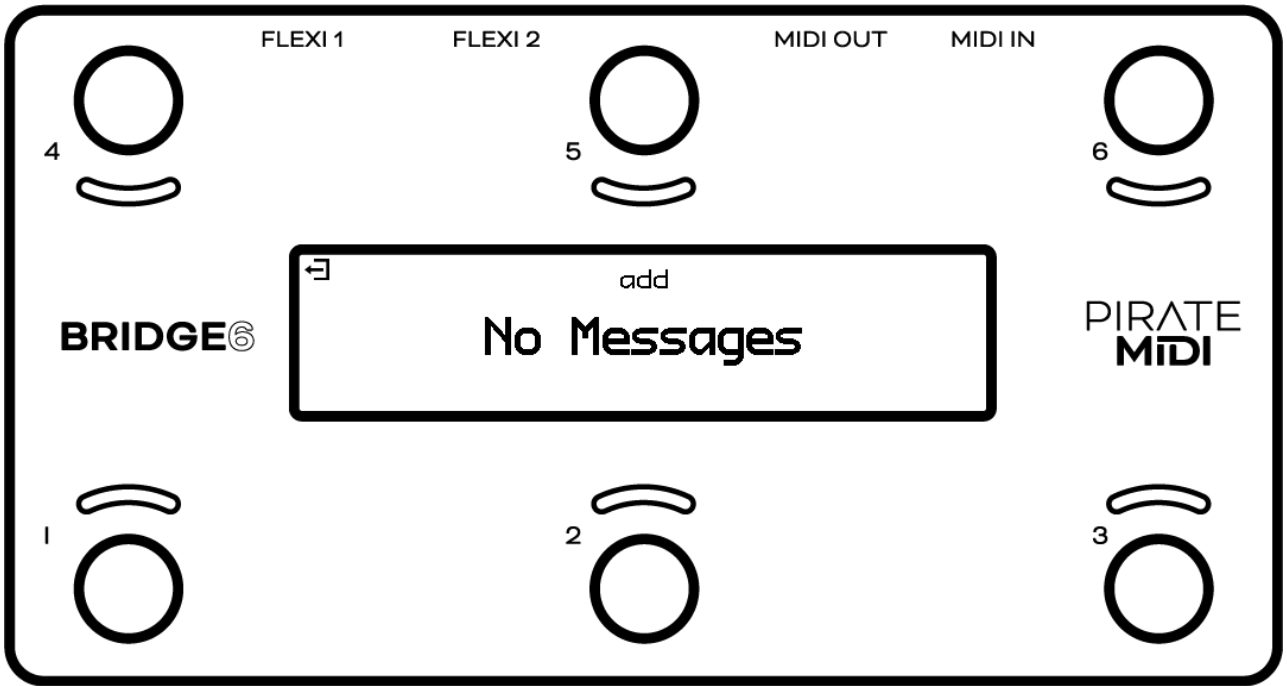

If there are already messages in the currently selected stack, the screen will look something like this

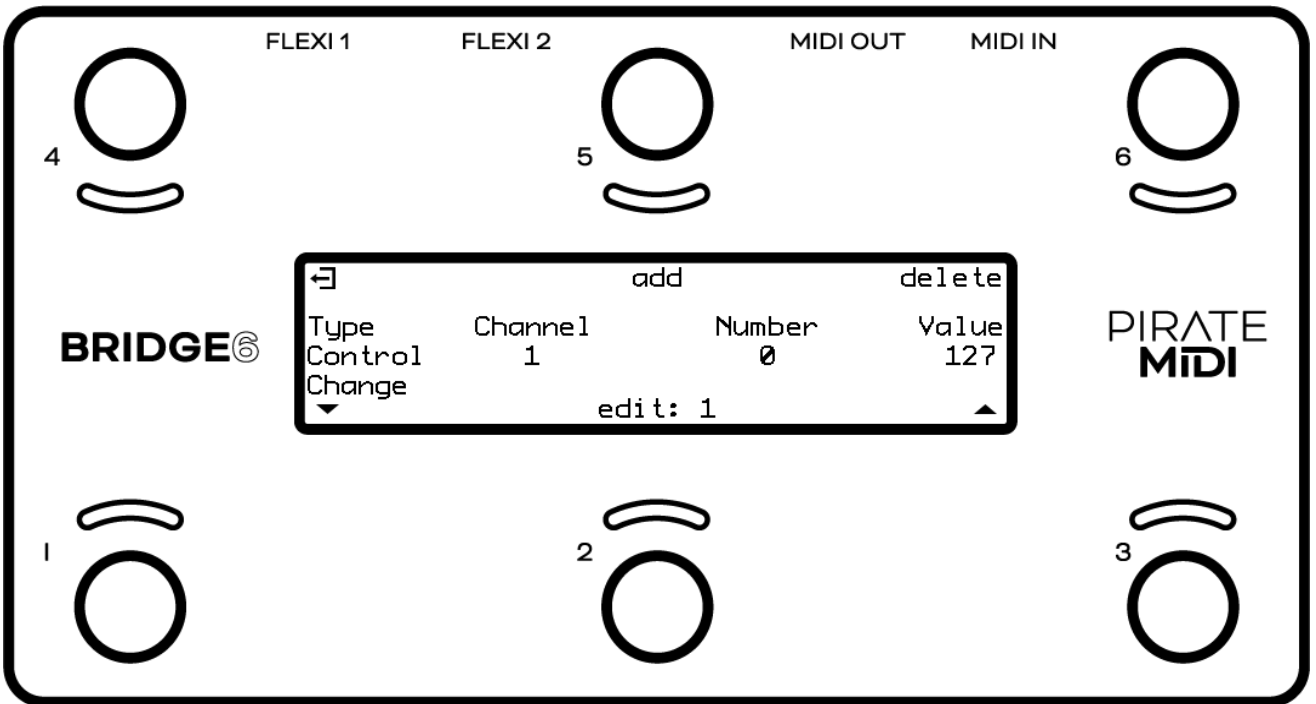

“Add”

Pressing switches 3+4 in this screen will allow you to add a new message to the stack. Once pressed the label saying "edit: 1" will change to "save: 1" Press switch 1+2 to save the message and exit the edit menu

"Delete"

Pressing switch 4 will delete the message you're currently viewing in the stack. You will be asked to confirm your choice.

"Edit: 'x'"

If there are multiple messages in the stack, you can scroll through them using switches 1 & 2. Pressing switches 1+2 will allow you to edit the currently selected message.

The number next to the "edit" label shows which number in the stack the current message is.

Editing Messages on Footswitches

After pressing switch 1+2 to "edit" a message, the highlighted selector box will appear and switch 3+4 & 4 will become navigation arrows.

Switch 1 & 2 will increase or decrease the currently selected value.

When editing a MIDI message you can choose:

1. Message Type
2. MIDI Channel
3. Number (*will not appear for all message types*)
4. Value (*will not appear for all message types*)
5. Time (*will only appear for delay messages*)
6. Note Number (*will only appear for note on/off messages*)

7. Velocity (*will only appear for note on/off messages*)

8. Outputs (*Flexi1, Flexi2, TRS, USB*)

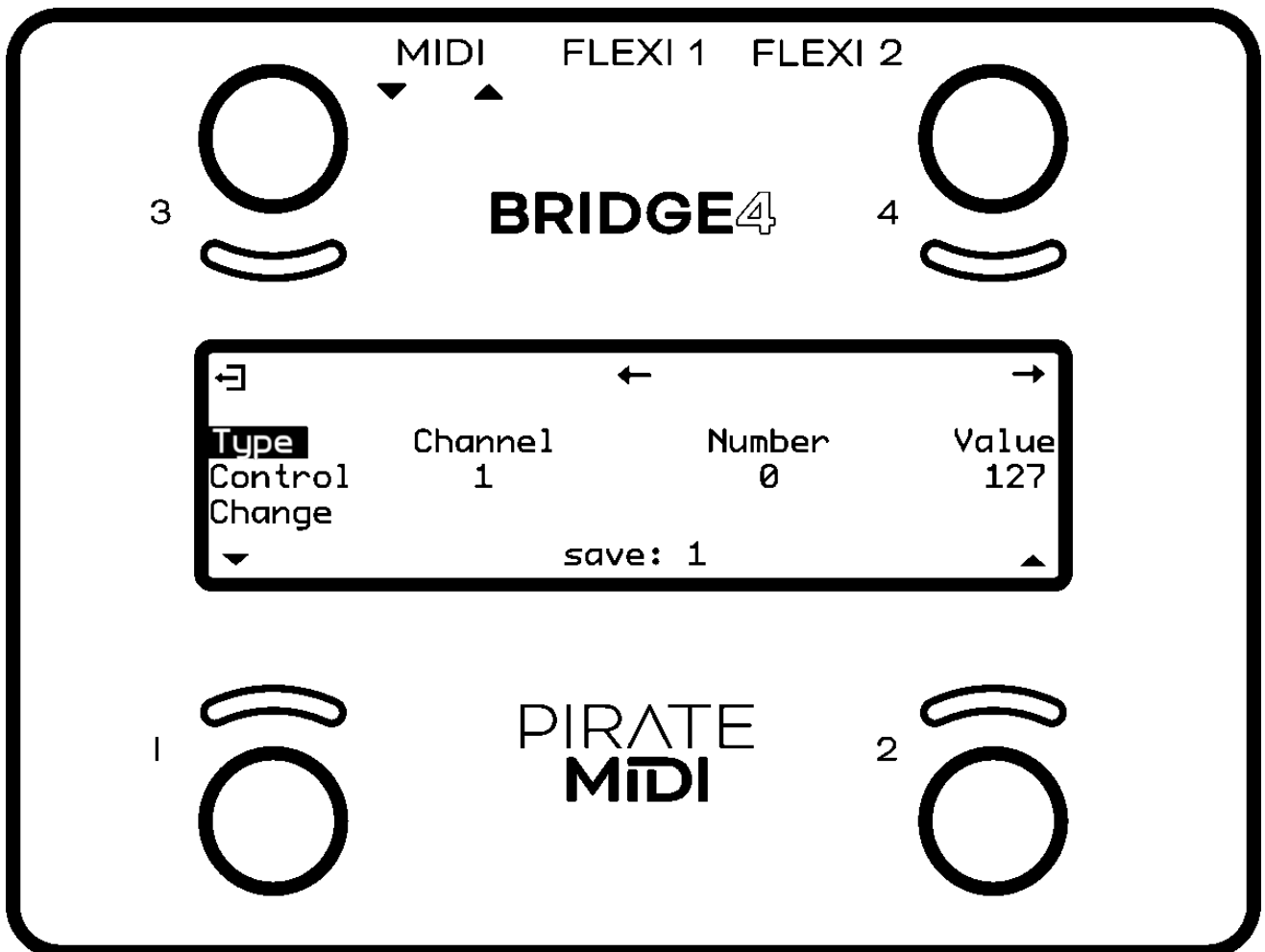

When you have finished editing a message, press switches 1+2 (save: 'x').

2. Expression Pedals

Viewing Messages on Expression Pedals

To view bank-level expression pedal messages, go to:

“ Menu > Exp Pedals > Exp ‘xx’ > Bank Messages “

All controls are the same as on switches (see above)

To view global expression pedal messages, go to:

“ Menu > Global > Global Exp Messages > Exp ‘xx’ > Messages “

All controls are the same as on switches (see above)

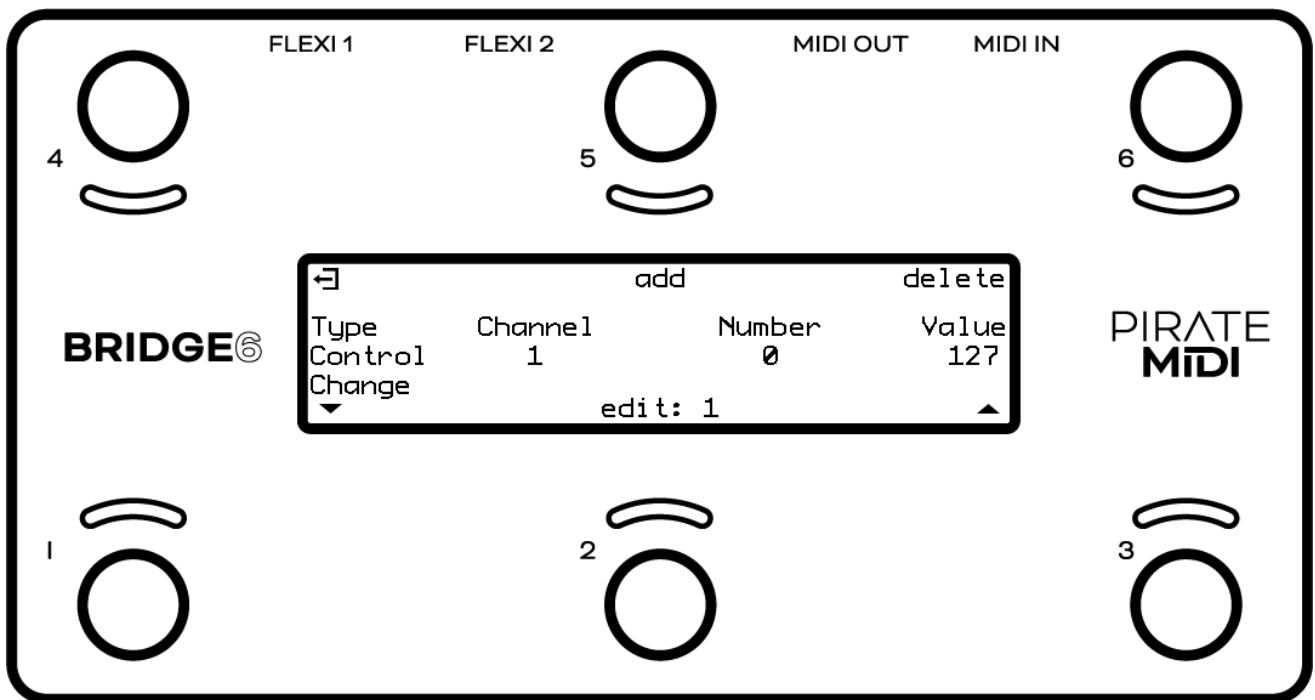

Editing Messages on Expression Pedals

Editing expression messages is exactly the same as editing switch messages. Although you will notice there are 3 screens of settings, not just 2. The third screen allows you to edit the min/max values of the expression message as well as the sweep type.

Some message types are unsuitable for expression pedals and are not available.

Min Value & Max Value

On the third screen of settings you can set the minimum value and the maximum value that the selected message will send. By default, MIDI messages minimum is 0 and maximum is 127.

Changing these values will affect the whole sweep of the pedal. For example, if you change the minimum value to 25 instead of 0, then the full heel-down position will be 25, instead of 0. Likewise with the maximum value. It will affect the full toe-down value and all values in between.

Sweep (curve)

This setting will affect the data interpolation applied to the values as you move the expression pedal from heel-down to toe-down.

- Linear
- Log
- Anti-Log

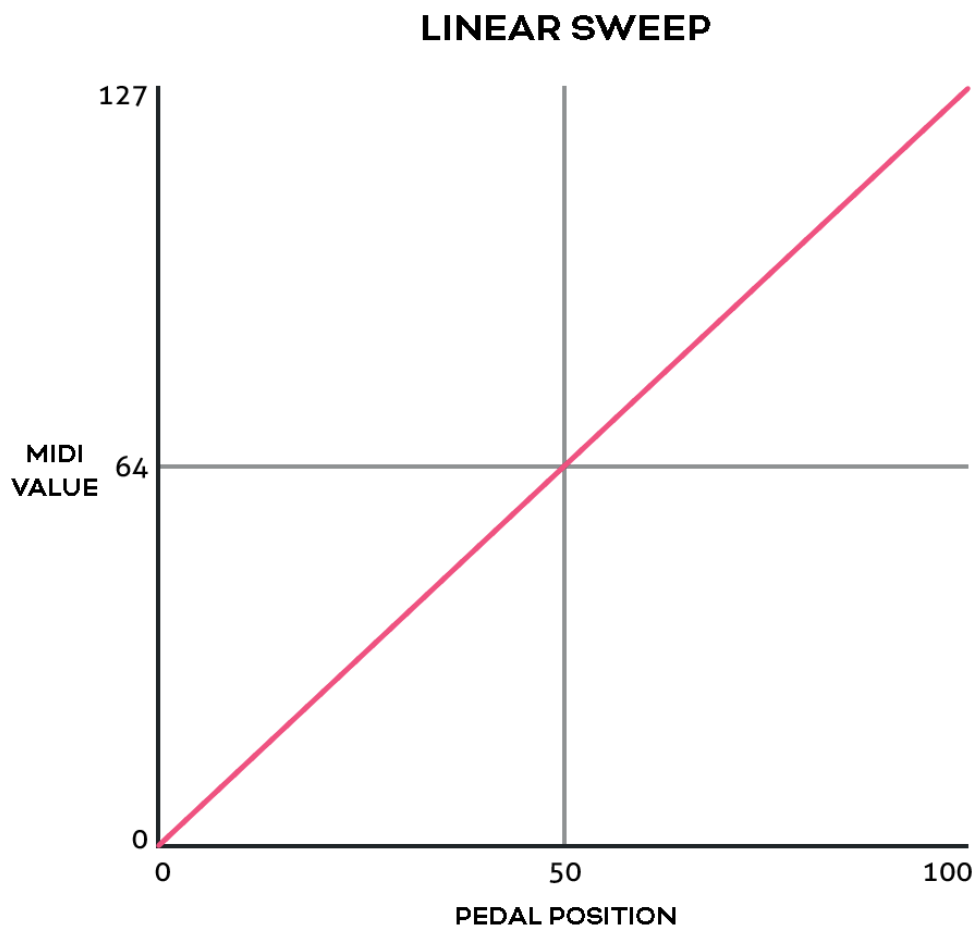

ANTI-LOG SWEEP

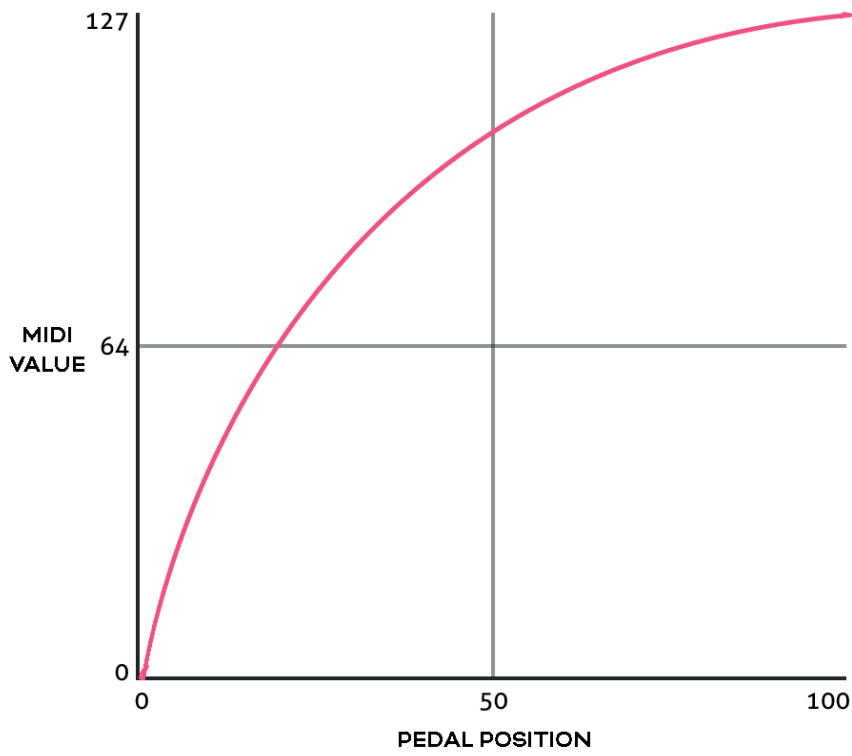

LOG SWEEP

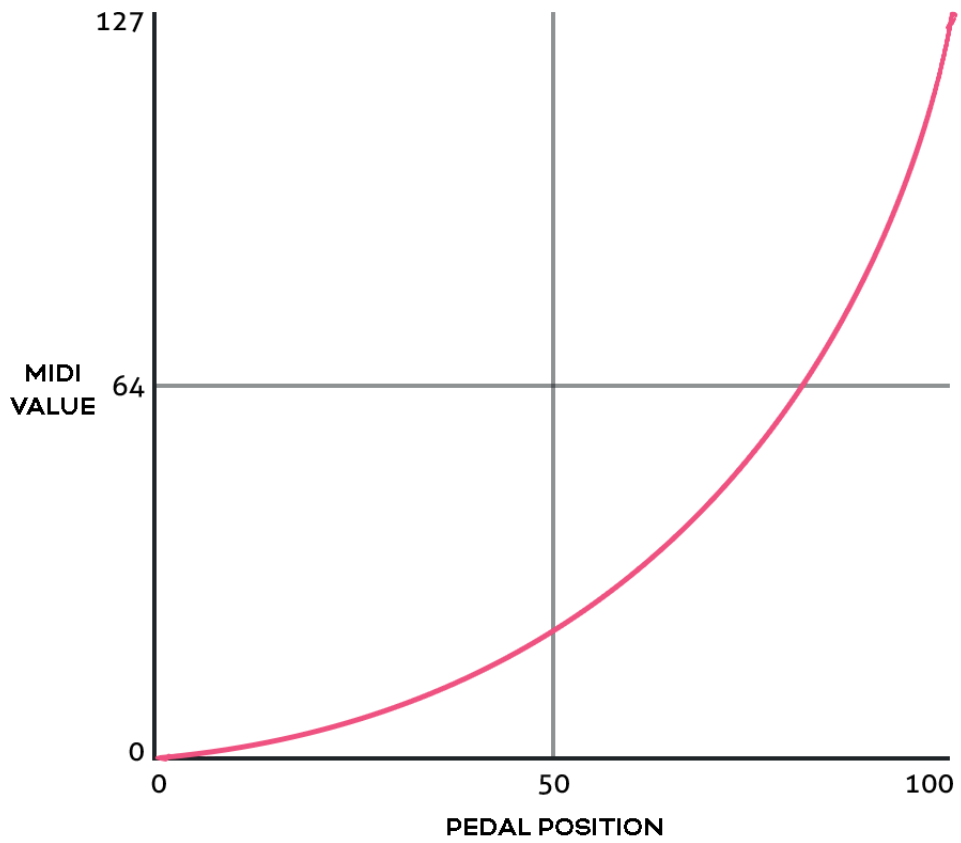

3. Bank Messages

Each bank has its own stack of 16 messages. These messages are automatically sent when that bank is selected.

To access this message stack for viewing and editing, go to:

“ Menu > Bank Messages “

All editing controls are the same as above.

5.2.2 MIDI Clock

Setting MIDI Clock Onboard

The BRIDGE4 has two onboard MIDI Clocks that can run simultaneously and independently with individual routing options.

1. Assigning MIDI Clock to a Footswitch

MIDI Clocks are a Global function, and will replace the per-bank settings of whichever footswitch is chosen.

To assign a clock to a switch, enter the menu and go to:

“ Menu > Global > Switches > Switch ‘x’ > Mode > Tap Tempo > MIDI Clock ‘X’ “

After choosing a MIDI Clock (A or B) to assign to the chosen switch, you can return to the main screen. You will see that your chosen switch has a new label showing the Name (A or B) and the current tempo. The tempo label will update as you use the switch to tap in a new tempo.

LED Indicators

You will also notice the secondary LED flashing the current tempo. The primary LED will be on by default. This means the clock is running and a start message has been sent. When the Primary LED is off, a stop message has been sent

Sending 'Start' & 'Stop' Messages

To send a 'Start' message, press and hold the switch (a start message is sent automatically when the clock is assigned to the switch).

To send a stop message, press and hold the switch and the LED will turn off to indicate the state. The secondary LED will keep flashing, and the clock impulses will continue to be sent (*this is how MIDI clock works. For detailed information, please refer to the [MIDI specification](#)*).

2. Assigning MIDI Clock Outputs

To choose which MIDI outputs each MIDI clock will be sent to, go to:

“ Menu > Global > MIDI > Clock 'X' > Clock Outputs “

Here you can select any or all of the MIDI outputs (Flexi1, Flexi2, DIN5, USB) for that clock to be sent to.

Note: Flexi1 and Flexi2 will be disabled if their Flexiport mode is not set to "MIDI Out."

3. Sending MIDI Clock as Analog Tap Impulses

Some devices like the [BOSS DD-20 giga delay](#) have an external tap input designed for a tap tempo external footswitch. The BRIDGE6 can send MIDI clock impulses as "Tap Tempo Out" to control the tap tempo of these non-MIDI devices.

To enable this, go to:

“ Menu > Global > Flexiports > Flexiport 'x' > Mode > Tap Tempo Out > MIDI Clock 'X' “

This will send analog tap tempo impulses from the Flexiport. This is linked to the footswitch assigned to that MIDI clock, so any tempo changes made on the BRIDGE6 are reflected in the Tap Tempo out.

Here is an [example video](#) with the Boss DD-20.

5.2.3 LFOs

Setting LFOs

The BRIDGE4 has two LFOs per bank that can run simultaneously and independently with deep customisation and flexibility.

LFOs are assigned to a particular message stack on a particular switch. When active, the secondary LED becomes an indicator of the LFO, showing both frequency and wave shape with the pulsing/fading of the LED itself.

To start setting LFO parameters, go to:

“ Menu > Switches > Switch ‘x’ > LFO “

Below you will find a visual representation of the three LFO settings pages.

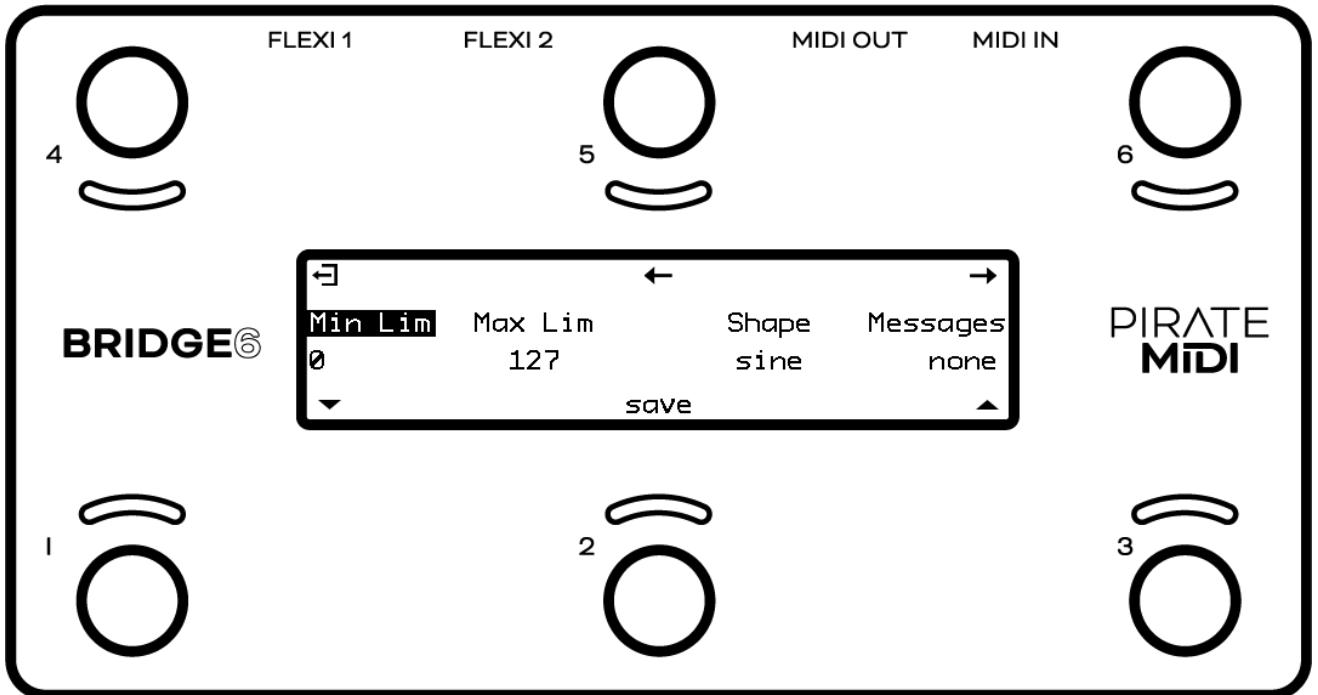
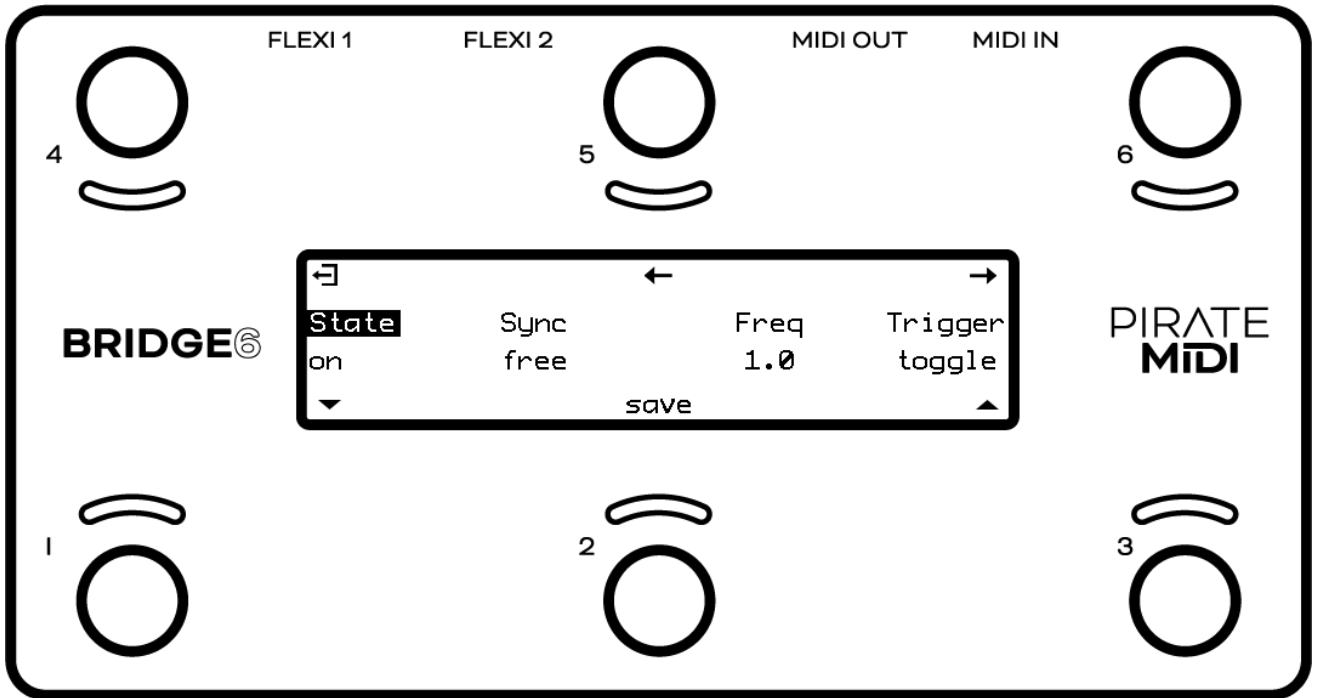

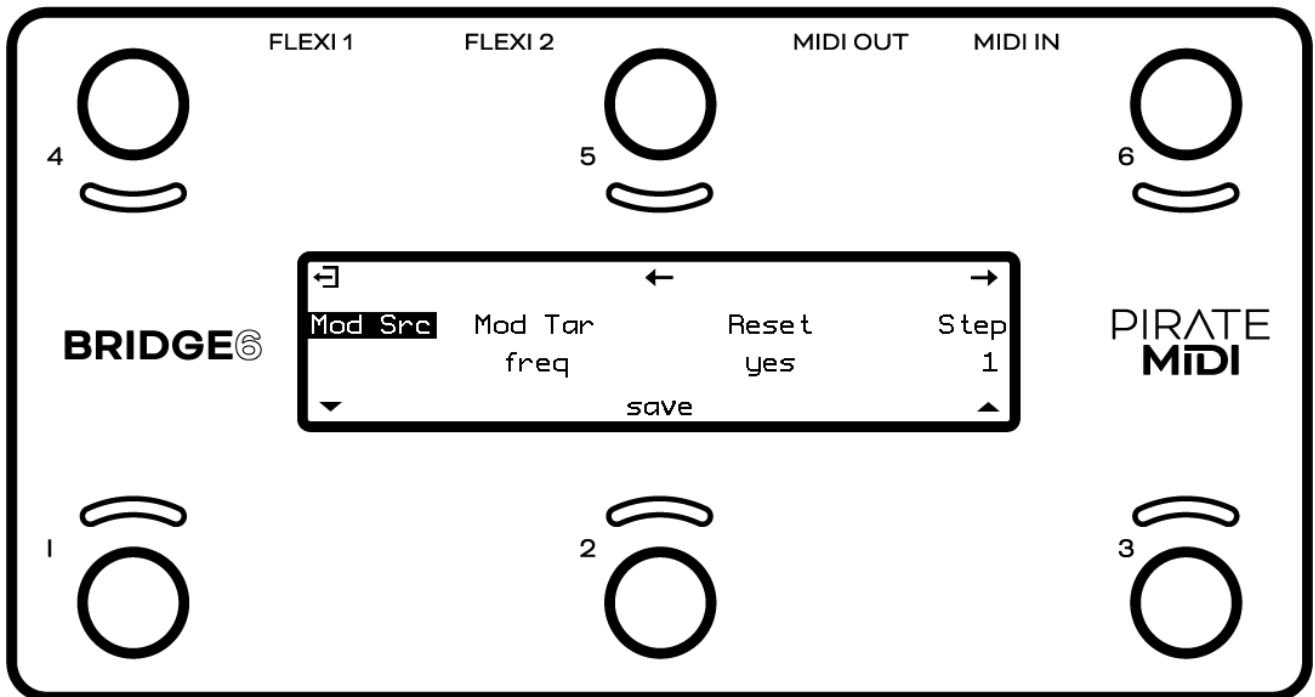

The following headings address each of the LFO settings available on these three screens.

1. LFO State

Toggle this setting between **on** or **off** to activate or deactivate the LFO.

Only two LFOs can be assigned per bank. If there are already two switches in the current bank with the LFO state set to 'on' the BRIDGE6 will tell you that there are no more LFO slots available and will not turn on the LFO.

2. LFO Sync

For each LFO you choose to activate, you can set a **free** frequency (default) or choose to sync to MIDI **clock A** or MIDI **clock B**.

3. LFO Frequency

This sets the frequency of the oscillation from the minimum value to the maximum value. In free sync mode, this is set in Hertz (times per second). The Hz range is from 0.1Hz to 10Hz.

When synced to MIDI clock, the frequency is set as a time division of the tempo.

Available Time Divisions

- 1/4
- 1/4t
- 1/4d
- 1/8
- 1/8t
- 1/8d
- 1/16
- 1/16t
- 1/16d

4. LFO Trigger

There are two options for triggering the LFO. **Toggle** or **Hold**.

Toggle will start the LFO after pressing the footswitch, and it will continue to run until you press the footswitch again to turn it off.

This is useful for auto-panning, auto-wah, oscillating frequencies with an EQ or other constant modulation.

Hold will run the LFO only while you hold down the footswitch.

This is useful for one-off intentional parameter changes, or for on-the-fly virtual knob twisting (press and hold to slowly turn up the MIDI-controllable gain knob on your drive pedal) or for Ramping effects like opening up a cutoff filter.

5. LFO Limits

The **Min Limit** and **Max Limit** parameters set the range that the LFO will oscillate between. If you want to limit the range of oscillation to be smaller than the full 0-127 values of a normal MIDI message, use these limits.

For example, I may use an LFO to auto-wah with an EQ, but I don't want to cover the whole sound spectrum - I just want to oscillate in the mids to high mids. So I set the **Min Limit** to 60 and the **Max Limit** to 100. This contains the parameter I'm modulating to just the upper mid section.

6. LFO Shape (waveform)

You can choose from 6 different waveform shapes to modulate your MIDI data.

- Sine
- Triangle
- Saw
- Ramp
- Square
- Random

Visual representations of the waveshapes can be seen below:

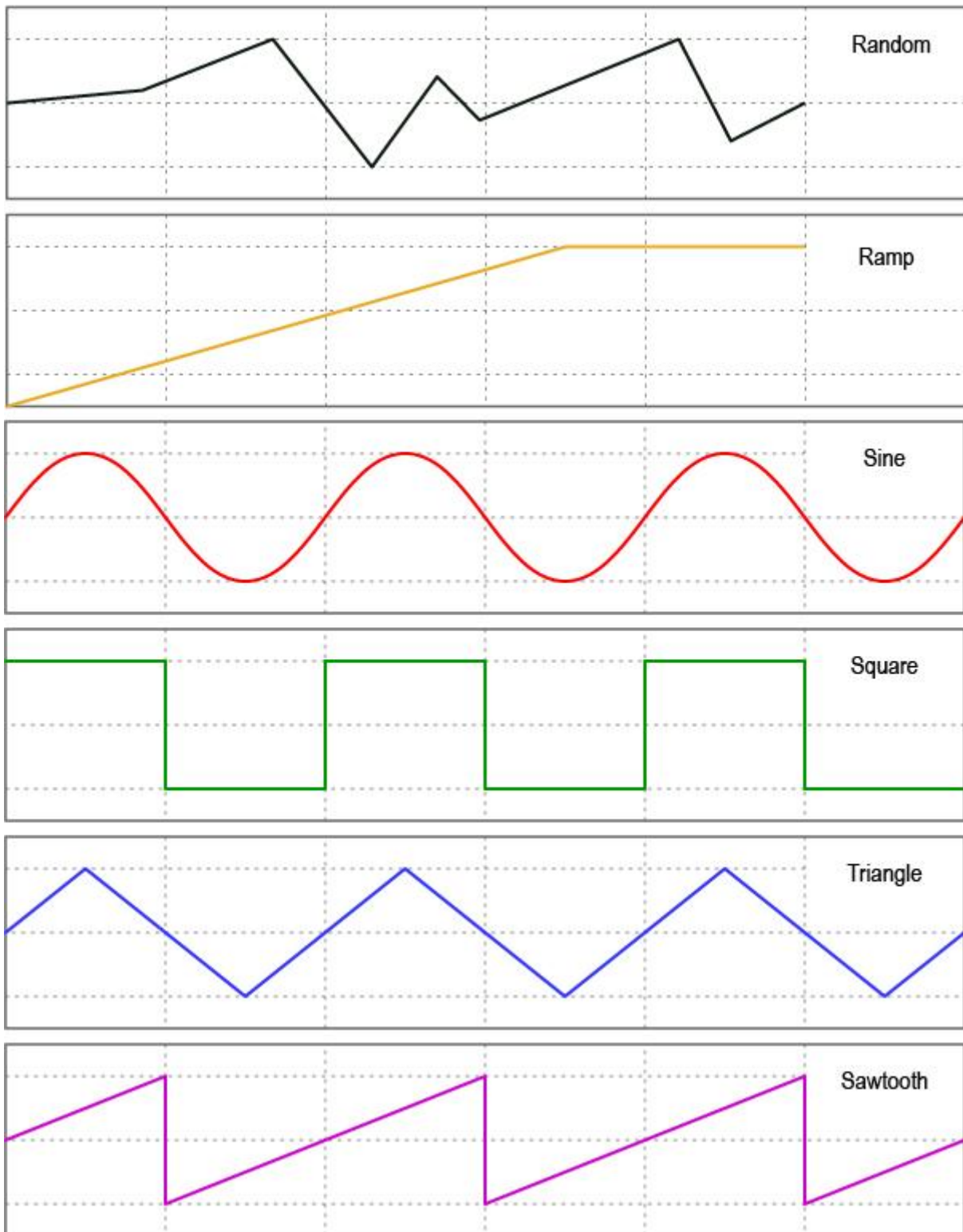

7. LFO Messages

This settings allows you to choose the message stack that the LFO will modulate. Any compatible message in this stack will be what the LFO uses to create the

oscillating MIDI data. For instance, if you choose the **toggle on** stack, then any messages in the toggle on stack are what the LFO will oscillate. If there are 12 MIDI CC messages in that stack, all 12 will be oscillated with the settings chosen.

8. LFO Modulation Source

Not currently active - please wait for a future update.

9. LFO Modulation Target

Not currently active - please wait for a future update.

10. LFO Reset

Choosing **yes** will reset the waveform each time you start or restart the LFO. Choosing **no** will keep continuous data between stops.

Turning reset to **no** is helpful for continually ramping parameters when using the **ramp** shape - rather than going back to the min value each time you activate the LFO, you can simply increase it gradually in multiple stages by starting and stopping the LFO a few times.

11. LFO Step

The *Step* refers to how smoothly the LFO changes the data of the MIDI messages. A step of **1** means that the data will only change by +/- 1 each time.

You can set the step value to 1, 2, 4, 8, 16, or 32.

Setting to a higher number will create a much more “stair-cased” effect with obvious and abrupt changes in parameter values.

12. Save & Exit

Now that you’ve chosen the settings for your LFO on this switch, press switch 1+2 to save and exit.

5.2.4 TRS Out

Setting TRS Out

PIRATE MIDI Flexiports can act as TRS switch outputs to control non-MIDI devices. Each footswitch can send a specific Tip, Ring or Tip+Ring message for each press type. The TRS Out settings are per bank.

1. Activating TRS Out Mode

To enable TRS Out, please set your chosen Flexiport to **Switch Out** mode.

“ Menu > Global > Flexiports > Flexiport ‘x’ > Mode > Switch Out “

2. Setting TRS Out per Switch

You can link any press type on any footswitch on any bank to a TRS switch out event. There is no limit to the number of switches or banks that you can link to switch out events.

Go to:

“ Menu > Switches > Switch ‘x’ > TRS Out > Press Type > Flexiport ‘x’ > Switch Type (Tip, Ring, Tip+Ring) “

Following this menu system is quite self-explanatory. You choose the switch you want to use to activate the switch out event, then you choose what type of press you want to use to activate it (Toggle On, Toggle Off, Press, Release, Double Press, Hold, Hold Release).

Then you choose which Flexiport the switch event will be sent to (you can choose any Flexiport, but it won't work unless you've set the Flexiport to **Switch Out** mode).

Lastly, select what type of switch signal you want to send - Tip, Ring, or Tip+Ring.

If you have a device that you want to switch with TRS events, please consult its user manual to decide what type of switch signal you need to send.



WARNING: Flexiports are **NOT** designed for Amp channel switching, relay switching, or any kind of signal with significant voltage.

If you are unsure, please be safe and ask us in our [Facebook group](#) or email us at support@piratemidi.com

Connecting your BRIDGE6 to an amplifier (if it is not a MIDI controllable amp) or some other relay switching device may void your warranty.

5.2.5 External Switch In

Setting External Switch Functions

PIRATE MIDI Flexiports can act as TRS switch inputs to offload some simple functions to external controls.

1. Activating Ext Switch In mode

To enable external switch functions, please set your chosen Flexiport to **Ext Switch In** mode.

“ Menu > Global > Flexiports > Flexiport ‘x’ > Mode > Ext Switch In “

2. Setting external switch functions

Single, double or triple auxiliary switches will work in **Ext Switch In** mode. Plug your aux switch into your Flexiport and then assign it a function or MIDI command:

“ Menu > Global > Flexiports > Flexiport ‘x’ > Ext Switch Config “

Using the menu (pictured below) you will be able to assign 3 auxiliary switches (Tip, Ring, Tip+Ring) to three different functions.

Currently the choice is as follows:

- None
- Bank Up
- Bank Down
- FS1
- FS2
- FS3
- FS4

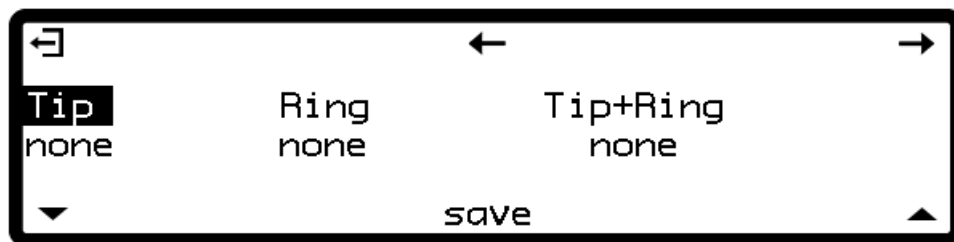

WARNING: Flexiports offer many operating modes. Not all of these modes are compatible with external devices.

In particular, the Switch Out mode allows a Flexiport to emulate a TRS switch output. This is designed to control devices that have an auxiliary switch input, or tap tempo footswitch jack.

Many devices use larger operating voltage and/or currents that the Flexiport is able to handle. Please go to piratemidi.com/compatibility for a list of devices we have checked for compatibility.

A Flexiport can also be damaged when using an incorrect mode with an external device attached. Make sure that you have enabled the correct Flexiport mode **BEFORE** connecting an external device.

Ignoring these warnings may void your warranty. Please make sure to contact us if you're unsure. Email support@piratemidi.com

6. Interface Settings

6.1 Bank Names

All 100 Banks on the BRIDGE4 can be named individually with up to 16 Characters. Upper case, lower case, numbers, and symbols are available.

Changing the Bank Name

First, select the bank you want to change the name on. Then got to:

“ Menu > Bank Name “

Here you can set up to 16 characters for the bank name using switches 1 & 2 to change the character and using switches 3+4 & 4 to move the cursor. Press switch 1+2 to save and exit.

Scroll Acceleration

To help you move through the characters quickly, you can press and hold down switch 1 or 2 to scroll through the characters. The longer you hold, the faster the scroll will become until you hit the acceleration ceiling.

6.2 Switch Labels (Scribble Strips)

Each switch can be given a different name in all 100 banks on the BRIDGE6. These labels can be up to 8 characters. Here's how to change them.

Changing & Customising Switch Labels

Go to:

“ Menu > Switches > Switch 'x' > Switch Name “

Use switches 1 & 2 to change the characters, and switches 3+4 & 4 to move the cursor.

Press switch 1+2 to save and exit.

6.3 LEDs

Each switch on the BRIDGE4 has a pair of LEDs. The left LED is called the Primary LED and the right is called the Secondary LED. The LEDs are addressable RGB (multi-colour) and can be customised per bank in both the onboard menus and the computer app.

LED Colour Selection

To change the colour of the primary or secondary LED, first select the bank that you want the change to affect. Then, go to:

“ Menu > LEDs > Switch 'x' > Primary/Secondary “

Here you will be able to choose from a number of pre-configured colours. The colour of the LED will change as you navigate the list so you can see what each colour looks like. For custom colour selection, use the computer app.

LED Behaviour

Primary LEDs

LED function is linked to the current mode of the footswitch. In Toggle mode, the Primary LED will light after a press, and then will be turned off on the second press.

In Momentary mode, the primary LED will light only when the switch is pressed.

In Tap Tempo (MIDI Clock) mode, the primary LED will be lit indicating that a start message has been sent. Holding the switch will send a stop message and turn off the primary LED.

Secondary LEDs

LED function is linked to the current mode of the footswitch. In Toggle mode, the secondary LED will light momentarily when the footswitch is held down. This helps you identify when a hold message has been triggered successfully.

In Tap Tempo (MIDI Clock) mode, the secondary LED will be flashing to indicate the current tempo. The flash rate will update as you tap new tempos.

6.4 Graphic User Interface

The User Interface (UI) of the BRIDGE4 main screen defaults to the **Extended UI** but it can be changed to the **Simple UI** if preferred.

How to change the UI

To change the UI from Extended to Simple, go to:

“ Menu > Global > Interface ” and choose **Simple UI** or **Extended UI**.

Simple UI

The **Simple UI** uses larger text labels, and removes icons, lines, and other UI elements. Only the switch labels and bank name are visible.

See an example below.

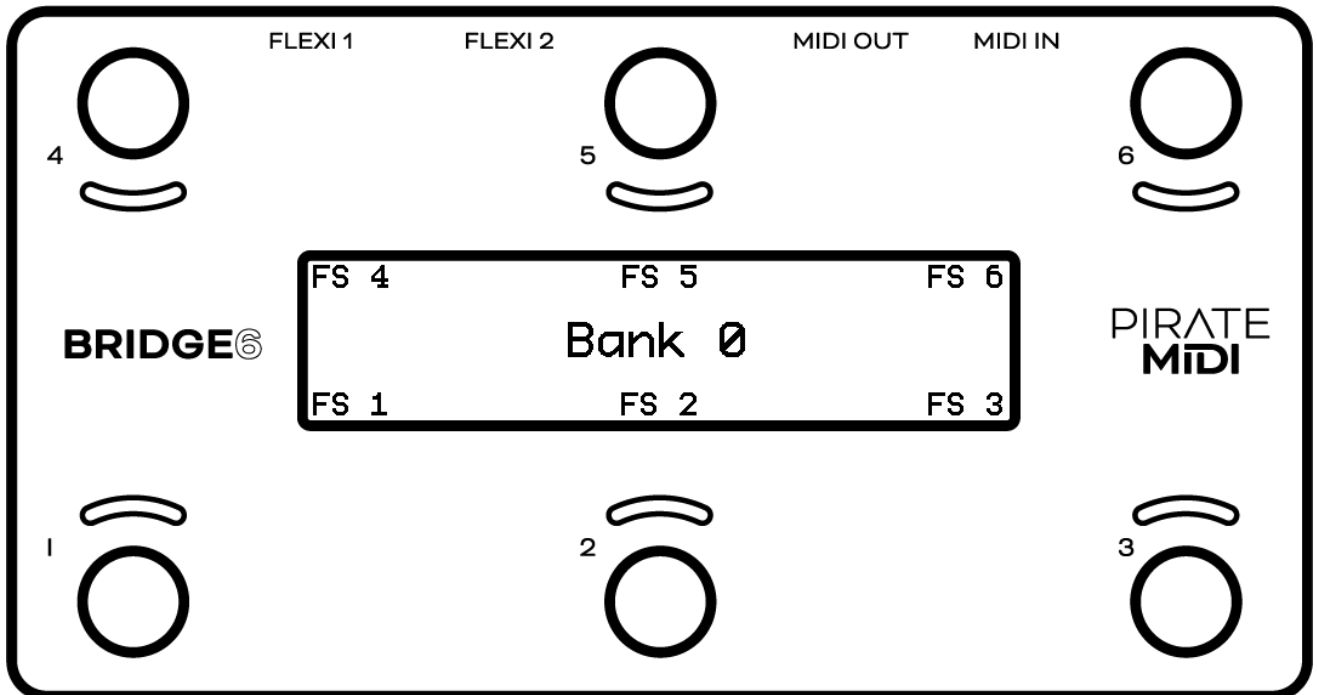

Extended UI

The **Extended UI** uses graphical elements to give you more information about the various features of the BRIDGE4.

Switch labels and bank name are still visible, but they are slightly smaller, and the bank name is left aligned. The bank up and down indicator icons are also present.

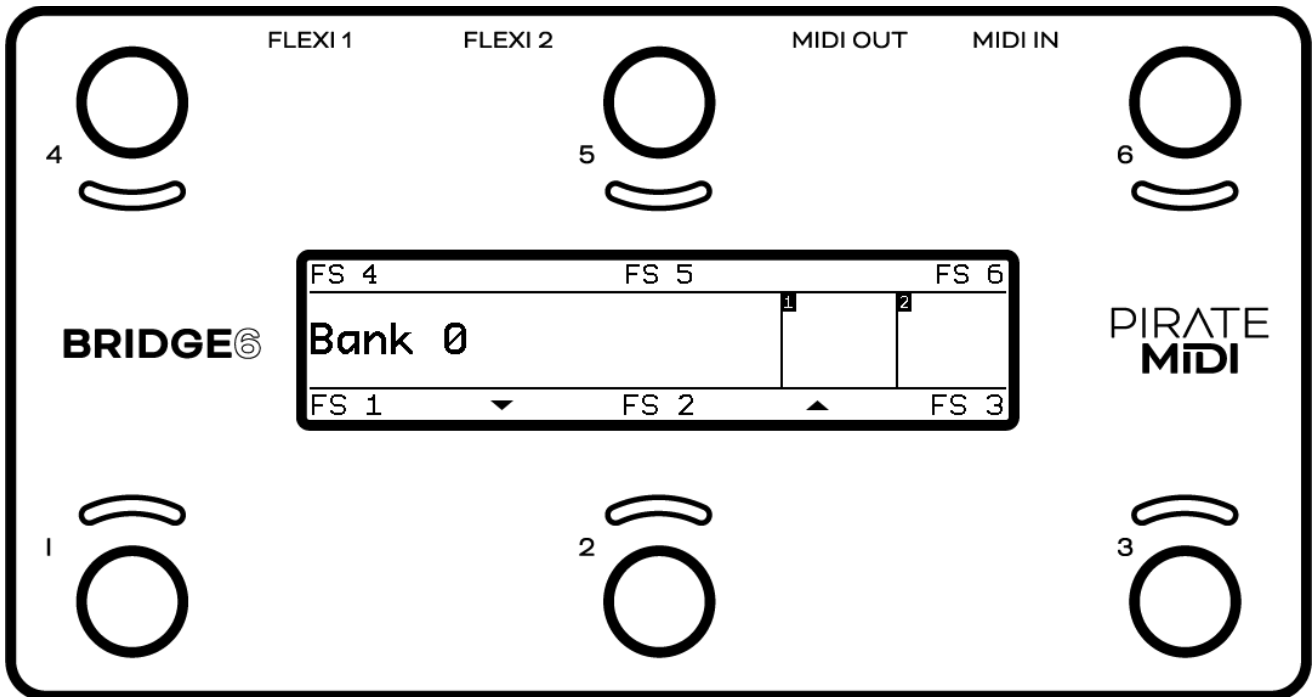

The most interesting feature of the **Extended UI** is the Flexiport Status section. You will notice two boxes labelled "1" and "2" which indicated the Flexiport number.

Depending on the mode that has been selected for the Flexiports, you will be given different graphical representations and helpful information here.

- In **MIDI Out** mode, an icon will be displayed to show MIDI out mode.
- In **Expression In** mode, a bar graph is displayed which shows the live position of the expression pedal. As the pedal moves, so does the bar graph. This is useful for confirming correct function and calibration of the expression pedal.

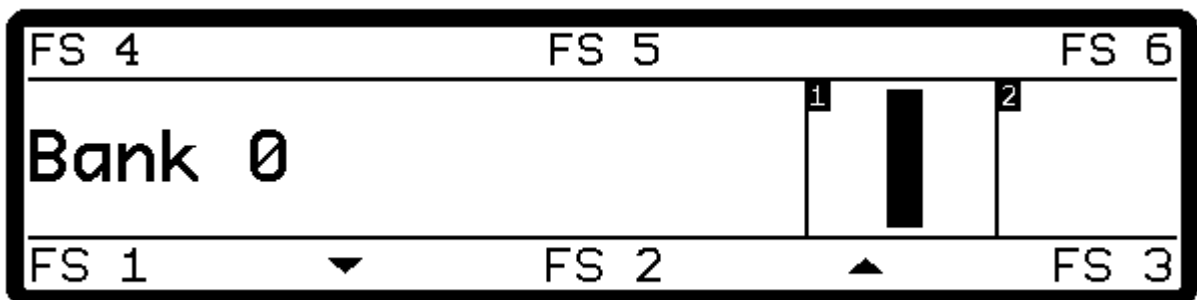

- In **Exp-Doubler In** mode, two bar graphs are displayed to show the position of the two expression pedals in the same way as Expression In mode.

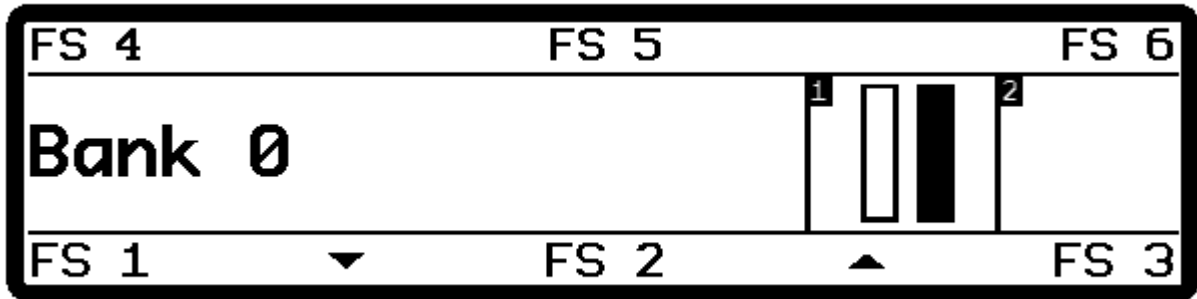

- In **Tap Tempo Out** mode, the time division of the clock will be displayed.
- In **Ext Switch In** mode, you will see 3 circles representing the 3 possible external switches. When the switch is pressed, the circle will change from an outline to a filled circle (example below). This is useful for confirming the correct function of the external switch.

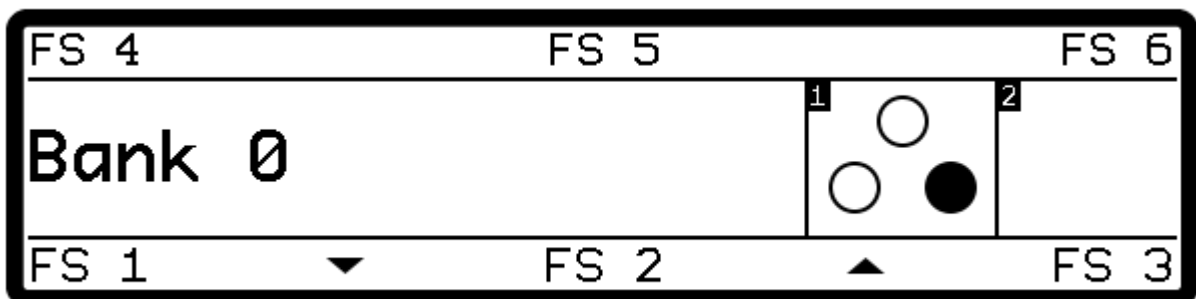

- In **Switch Out** mode, you will see a representation of the Tip, Ring and Tip+Ring switch out events.
- In Device Link mode, you will see a label indicating whether the device is in **Master** mode or **Slave** mode.

7. Updating

Updating the Firmware

The BRIDGE4 will be receiving ongoing updates, bug fixes, and feature add-ons. Firmware updates are performed with a computer when the BRIDGE4 is connected via USB.

After connecting your device to the computer, **please make sure it is the only PIRATE MIDI device connected to the computer.**

Please remember to connect the two flexiports together using a TS or TRS cable. If this is not done, your computer may not recognise the BRIDGE6 as it enters firmware update mode.

When the process is finished, the screen on the BRIDGE6 will be blank. Please remove the USB cable to power it down. You may immediately replace the USB cable to power the BRIDGE4 back on and to complete the update. Your BRIDGE4 is now ready to use again.

For full instructions, go to learn.piratemidi.com

Troubleshooting

If, for some reason, the update is not successful or the process is not able to start, please contact us at support@piratemidi.com

We are able to update the firmware manually using a different process.

8. MIDI Implementation

The BRIDGE4 can itself be controlled by MIDI from an external MIDI device via the dedicated MIDI In (3.5mm TRS) or USB MIDI.

You can set the MIDI channel in the menu (Menu>Global>MIDI>Channel).

MIDI Implementation Chart

Function	MIDI CC#	Value
Navigation		
Bank Up	20	Any (0-127)
Bank Down	21	Any (0-127)
Go to Bank 'x'	22	0-99
Go to Bank 'x' (PC)	PC	0-99
Menu/UI		
Enter/Exit Menu	23	Any (0-127)
Change to Simple UI	30	0
Change to Standard UI	30	127
Toggle UI	30	64
Footswitch Action Control		
FS 1: Switch Off	0	0
FS 1: Switch On	0	1
FS 1: Toggle	0	2
FS 1: Press Action	0	3
FS 1: Release Action	0	4
FS 1: Double Press Action	0	5
FS 1: Hold Action	0	6
FS 1: Hold Release Action	0	7
FS 2: Switch Off	1	0
FS 2: Switch On	1	1
FS 2: Toggle	1	2

FS 2: Press Action	1	3
FS 2: Release Action	1	4
FS 2: Double Press Action	1	5
FS 2: Hold Action	1	6
FS 2: Hold Release Action	1	7
FS 3: Switch Off	2	0
FS 3: Switch On	2	1
FS 3: Toggle	2	2
FS 3: Press Action	2	3
FS 3: Release Action	2	4
FS 3: Double Press Action	2	5
FS 3: Hold Action	2	6
FS 3: Hold Release Action	2	7
FS 4: Switch Off	3	0
FS 4: Switch On	3	1
FS 4: Toggle	3	2
FS 4: Press Action	3	3
FS 4: Release Action	3	4
FS 4: Double Press Action	3	5
FS 4: Hold Action	3	6
FS 4: Hold Release Action	3	7
Direct FS Control		
FS 1: Emulated Press	10	127
FS 1: Emulated Release	10	0
FS 2: Emulated Press	11	127

FS 2: Emulated Release	11	0
FS 3: Emulated Press	12	127
FS 3: Emulated Release	12	0
FS 4: Emulated Press	13	127
FS 4: Emulated Release	13	0

9. Menu Tree / Glossary

Now we'll look at all the menu items and their sub-menus on your BRIDGE6. These items will be covered in greater detail in dedicated sections.

Top-Level Menu Items

- **LEDs**

Here you can change the colour of the 8 RGB LEDs.

- **Bank Name**

Here you can change the name of the current bank.

- **Switches**

This is where you will change LFO settings, MIDI message stacks, switch labels (scribble strips), and the TRS out settings for each of the 4 onboard switches

- **Bank Messages**

Each bank can have a stack of MIDI messages that it sends when entering that bank. Edit it here.

- **Exp Pedals**

Edit the MIDI message stacks for each expression pedal here.

This is for the messages associated with the current bank only. Global Exp message stacks are found in the 'Global' menu.

- **Global**

Settings that affect the whole device (not per bank) are found here. Switch modes, MIDI channel and routing, Flexiport modes, and global expression pedal message stacks.

- **System**

View firmware version number, reset, or diagnose hardware problems with your device.

Sub-Menu Items

Top-level menu items not mentioned here do not have sub-menu items. They go directly to their named function.

- **LEDs**

After selecting which switch to edit (1-4) you will see the following sub-menu items:

- **Primary**

Change the colour of the primary (left) LED.

- **Secondary**

Change the colour of the secondary (right) LED.

If you want to create your own colour (not from the list of 7), you will need to use the desktop app.

- **Switches**

After selecting which switch to edit (1-4) you will see the following sub-menu items:

- **LFO**

Edit the LFO settings for the selected switch

- **Messages**

Edit the MIDI message stacks for each of the switch press types (Toggle On, Toggle Off, Press, Release, Double Press, Hold, Hold Release) for the selected switch.

- **Switch Name**

Customise the switch label for the current bank. Maximum 8 characters/symbols

- **TRS Out**

If you have a Flexiport assigned as a 'Switch Out' you can use these settings to trigger a TRS switch out event (Tip, Ring or Tip+Ring) for any of the press types (Toggle On, Toggle Off, Hold, etc.) of the selected switch.

- **Exp Pedals**

After selecting an expression pedal to edit (1A, 1B, 2A, 2B) you will see the following sub-menu items:

- **Bank Messages**

Edit the MIDI message stacks for the selected expression pedal.

- **Global**

- **Switches**

After selecting which switch to edit (1-4) you will be able to select the global function of the switch. This includes:

- Toggle
- Tap Tempo
- Sequential
- Momentary

- **MIDI**

- **Channel**

Select the MIDI channel that your controller will respond to when given remote commands via MIDI.

- **Thru Routing**
Independently edit the MIDI Thru routing for the TRS MIDI In & the USB MIDI In.

- **Clock A**
Select the outputs you want your MIDI clock to be sent to.

- **Clock B**
Select the outputs you want your MIDI clock to be sent to.

- **Flexiports**
Set the Flexiport mode for each Flexiport (MIDI Out, Exp In, Exp-Doubler In, Tap Tempo Out, Ext Switch In, Switch Out, Device Link).

- **Global Exp Messages**
After selecting an expression pedal to edit (1A, 1B, 2A, 2B) you will be able to edit the global MIDI message stack for that expression pedal.

- **Interface**
 - **Brightness**
Adjust the global LED brightness (Low, Medium, High).

 - **Simple UI**
Activate the Simple UI - larger text with only switch and bank labels

 - **Extended UI**
Activate the Extended UI - Text labels for bank and switches as well as graphical elements to show Flexiport modes and activity.

- **System**
 - **Firmware Version Number (e.g “v1.0.0”)**
You can quote this firmware version number in any bug reports or support tickets you lodge.

- **Reset**
Completely erase all settings and restore the firmware to a default state.
- **Diagnostics**
A special test routine that will confirm all hardware inputs and outputs are working correctly (LEDs, Switches, MIDI in/out).
- **Manual Update**
In case of a problem with updating firmware through the app, support staff may ask you to enter the update mode manually using this menu.