

## office

L'UFFICIO MODERNO DEVE SAPER RISPONDERE ALLE RICHIESTE DI MAGGIORE FLESSIBILITÀ E CONDIVISIONE. L'OBIETTIVO È TROVARE UN EQUILIBRIO TRA SPAZIO DI LAVORO PRIVATO E SPAZIO DESTINATO ALL'INCONTRO E ALLO SCAMBIO DI INFORMAZIONI. IL DESIGN POP SI FONDE PERFETTAMENTE CON QUALSIASI AMBIENTE.

THE MODERN OFFICE MUST BE ABLE TO MEET THE DEMANDS FOR INCREASED FLEXIBILITY AND SHARING. THE AIM IS TO FIND A BALANCE BETWEEN PRIVATE WORKING SPACES AND SPACES DESTINED FOR MEETING AND EXCHANGING INFORMATION. THE POP DESIGN SEAMLESSLY BLENDS WITH ANY INTERIOR.

LE BUREAU MODERNE DOIT POUVOIR RÉPONDRE AUX DEMANDES DE FLEXIBILITÉ ET DE PARTAGE ACCRUES. L'OBJECTIF EST DE TROUVER UN ÉQUILIBRE ENTRE ESPACE PRIVÉ ET ESPACE DE RÉUNION ET D'ÉCHANGE D'INFORMATIONS. LE DESIGN POP S'INTÈGRE PARFAITEMENT À TOUS LES INTÉRIEURS.



**POP WOODY**

Scrivania e tavoli bench con struttura in metallo verniciato nero (RAL 9005) e gamba in frassino naturale verniciato trasparente.  
Piano in melaminico bianco.

Desk and bench desks with black metal structure (RAL 9005) and leg in natural ash, clear varnished.  
White melamine top.

Bureau et bureaux doubles avec structure métallique noire (RAL 9005) et piétement en frêne naturel verni transparent.  
Plateau en mélamine blanche.

**CLASSE 6 - EM60**

Seduta operativa / Task chair /  
Siège bureau  
Remix 3 - RIRB

**YO STOOL**

Design: Giacobone + Roj  
Progetto CMR  
Go Check - T9R5, T9R6





**POP WOODY**

Il programma di arredo ufficio Pop woody risponde a moderne e molteplici esigenze di lavoro, per momenti individuali di concentrazione o attività collaborative.

Scrivania e bench con mobile di servizio. Gamba in frassino naturale verniciato trasparente e struttura in metallo verniciato nero (RAL 9005). Piano in melaminico bianco.

**CLASSE 6 - EM60**

Seduta operativa / Task chair / Siège bureau  
Remix 3 - RIRB

Pop woody's office furniture program responds to modern and multiple working necessities, from individual activities that require concentration to group ones that require collaboration.

Desk and bench desk with service unit. Black metal structure (RAL 9005) and leg in natural ash, clear varnished. White melamine top.

La collection de mobilier de bureau Pop woody répond aux plusieurs besoins de travail modernes. Concentration individuelle ou activités collaboratives.

Bureau et bureau double avec meuble de service. Structure métallique noire (RAL 9005) avec piétement en frêne naturel verni transparent. Plateau en mélamine blanche.







#### POP WOODY

Bench 4 posti e tavolo riunioni con gamba in frassino naturale verniciato trasparente e struttura in metallo verniciato bianco (RAL 9010). Piano in melaminico bianco.

4 person bench desk and meeting table with white (RAL 9010) metal structure and leg in natural ash, clear varnished. White melamine top.

Bureau 4 postes et table de réunion avec structure métallique blanche (RAL 9010) et piétement en frêne naturel verni transparent. Plateau en mélamine blanche.

#### CLASSE 4 - EM 49

Seduta operativa / Task chair / Siège bureau

Rete / Mesh / Résille: Polo - RPG1  
Tessuto / Fabric / Tissu:  
Jet - JT1R

#### YO

design Giacobone + Roj Progetto CMR  
Seduta multifunzione / Multipurpose chair / Chaise polyvalente

Telaio a 4 gambe / 4-leg frame / Bâti 4 pieds: bianco - white - blanc RAL 9010  
Tessuto / Fabric / Tissu: Jet - JT1R





**POP WOODY**

Pop woody nasce dalla combinazione di una struttura metallica abbinata alla bellezza del legno massello in frassino naturale verniciato trasparente.

Bench 4 posti con gamba in frassino naturale verniciato trasparente e struttura in metallo verniciato bianco (RAL 9010). Piano in melaminico finitura cemento.

**LOL**

Seduta operativa / Task chair / Siège bureau  
Jet - JT07

Pop woody was born from the combination between a metallic structure and beautiful clear-painted natural ash solid wood.

4 person bench desk and meeting table with white (RAL 9010) metal structure and leg in natural ash, clear varnished. Concrete melamine top.

Pop woody est la combinaison d'une structure métallique alliée à la beauté du bois massif en frêne naturel verni transparent.

Bureau 4 postes avec structure métallique blanche (RAL 9010) et piétement en frêne naturel verni transparent. Plateau en mélamine finition béton.



### POP ACE

Scrivania con contenitore.  
Struttura in metallo verniciato  
nero (RAL 9005) e piano in  
melaminico noce canaletto.

Desk with service unit. Black  
(RAL 9005) metal structure and  
american walnut melamine top.

Bureau avec meuble de service.  
Structure métallique noire (RAL  
9005) et plateau en mélamine  
finition noyer américain.

### LOL

Seduta operativa / Task chair /  
Siège bureau  
Remix 3 - RIRB



LOL  
Seduta operativa / Task chair / Siège bureau  
King Flex - XFYD

### GUARD SCREEN

In questo periodo di cambiamenti, vengono richieste misure di sicurezza sul posto di lavoro per proteggere la salute delle persone. Per questo motivo, è necessario attuare dei cambiamenti negli ambienti di lavoro studiati sia nel breve che lungo termine.

Guard Screen in melaminico bianco (H. 60 cm).  
Guard Screen: schermi rivestiti in tessuto con prolunga in vetro (H. 22 cm).

In these times of change, new safety measures are required to protect and safeguard the health of people in the workplace. For this reason, it's necessary to implement changes in the working environment that are designed for both the short and long term.

Guard Screen in white melamine (H. 60 cm).  
Guard Screen: upholstered fabric screen with upper glass (H. 22 cm).

En cette période de changements, de nouvelles mesures de sécurité sont nécessaires pour protéger la santé des personnes sur le lieu de travail. Pour cette raison, il est nécessaire d'activer des changements qui soient conçus à la fois pour le court et le long terme.

Guard Screen en mélamine blanche (Ht. 60 cm).  
Guard Screen: panneau écran revêtu en tissu et extension en verre supérieur (Ht. 22 cm).

### POP ACE

Bench 4 posti, struttura in metallo verniciato bianco (RAL 9010) e piano in melaminico bianco.

4 person bench desk with white (RAL 9010) metal structure and white melamine top.

Bureau 4 postes avec structure métallique blanche (RAL 9010) et plateau en mélamine blanche.

### POP WOODY

Bench 4 posti, struttura in metallo verniciato bianco (RAL 9010) e gamba in frassino naturale verniciato trasparente. Piano in melaminico bianco.

4 person bench desk with white (RAL 9010) metal structure and leg in natural ash, clear varnished. White melamine top.

Bureau 4 postes avec structure métallique blanche (RAL 9010) et piétement en frêne naturel verni transparent. Plateau en mélamine blanche.





**POP EASY**

Scrivania con allungo laterale. Struttura in metallo verniciato bianco (RAL 9010) e piano in melaminico bianco.

L-shaped desk with white (RAL 9010) metal structure and white melamine top.

Bureau avec retour lateral avec structure en métal blanc (RAL 9010) et plateau en mélamine blanche.

**POP SQUARE**

Scrivania con mobile di servizio portante. Struttura in metallo verniciato bianco (RAL 9010) e piano in melaminico bianco.

Desk with service unit. White (RAL 9010) metal structure and white melamine top.

Bureau avec meuble de service. Structure métallique blanche (RAL 9010) et plateau en mélamine blanche.

**FIOR DI LOTO**

design C. Bellini  
Seduta multifunzione / Multipurpose chair /  
Siège polyvalent  
Remix 3 - RIGR







**POP EASY**  
Bench 6 posti con struttura bianca (RAL 9010) e piani in melaminico bianco.

6 person bench desk with white (RAL 9010) metal structure and white melamine tops.

Bureau 6 places avec structure métallique blanche (RAL 9010) et plateaux en mélamine blanche.

**FIOR DI LOTO**  
design C. Bellini  
Seduta multifunzione con carter retro schienale in plastica Baydur.

Multipurpose chair with rear side of backrest in Baydur plastic.

Siège polyvalent avec arrière du dossier en plastique Baydur.

Bondai - TBB6





I contenitori sospesi in metallo sono una soluzione di archiviazione particolarmente adatta per postazioni operative di dimensioni ridotte.

Metal hanging filing units are the perfect storage solutions for small sized operative workstations.

Les éléments en métal suspendus sont une solution pour l'archivage particulièrement adaptée aux petits postes de travail.

Cassetto metallico sospeso con portacasco / portaborse

Hanging metal drawer with helmet / bag holder

Tiroir suspendu en métal avec porte casque / sac

Porta CPU metallico appeso

Hanging metal PC holder

Support UC métallique suspendu



Gli schermi divisorii possono essere dotati di una barra attrezzabile che consente l'aggancio di diversi accessori rendendo le postazioni funzionali ed accoglienti.

The dividing screens can be equipped with a toolbar that allows the attachment of various accessories, allowing the workstation to be functional and tidy.

Les panneaux écran peuvent être équipés d'une barre d'outils qui permet de fixer divers accessoires, pour rendre le poste de travail fonctionnel et bien rangé.

Porta documenti metallico

Metallic document holder

Porte-documents en métal





#### **POP SQUARE**

Bench 4 posti con struttura in metallo verniciato bianco (RAL 9010) e piani in melaminico bianco.

4 person bench desk with white (RAL 9010) metal structure and white melamine tops.

Bureau 4 postes avec structure métallique blanche (RAL 9010) et plateaux en mélamine blanche.

#### **FIOR DI LOTO**

design C. Bellini

Seduta multifunzione con carter retro schienale in plastica Baydur.

Multipurpose chair with rear side of backrest in Baydur plastic.

Siège polyvalent avec arrière du dossier en plastique Baydur.

Bondai - TBV2





flap multipresa: possibilità di accessoriare il piano di lavoro con sistemi multipresa.

Pannelli di chiusura in melaminico integrati alle strutture della scrivania per garantire una privacy totale.



multisocket flap: can be added to the desk top.

Melamine closing panels, integrated to the desk's structure, can be added to guarantee total privacy.

top accès polyvalent: possibilité d'équiper le plan de travail d'un top accès intégré avec multiprises.

Panneaux de fermeture en mélamine intégrés à la structure du bureau pour garantir une privacy totale.

#### POP EASY

Scrivanie in linea con allungo. Struttura in metallo verniciato bianco (RAL 9010) e piani in melaminico bianco.

Linear desks with return top. White (RAL 9010) metal structure and white melamine tops.

Bureaux en ligne avec retour. Structure métallique blanche (RAL 9010) et plateaux en mélamine blanche.

#### FIOR DI LOTO

design C. Bellini

Seduta multifunzione con carter retro schienale in plastica Baydur.

Multipurpose chair with rear side of backrest in Baydur plastic.

Siège polyvalent avec arrière du dossier en plastique Baydur.

Bondai - TBV2







#### **POP TEE**

Scrivania con gamba a T e cassetiera H. scrivania. Struttura in metallo verniciato bianco (RAL 9010) e piano in melaminico bianco.

T-leg desk and desk-height pedestal. White (RAL 9010) metal structure and white melamine top.

Bureau avec piétement de forme T et caisson Ht. bureau. Structure métallique blanche (RAL 9010) et plateau en mélamine blanche.

#### **CLASSE 5 - EM59**

Seduta operativa / Task chair / Siège bureau

Bodai - TBGC





**POP TEE**

Scrivania con gamba a T e mobile di servizio. Struttura in metallo verniciato bianco (RAL 9010) e piano in melaminico bianco.

T-leg desk with service unit. White (RAL 9010) metal structure and white melamine top.

Bureau avec piétement de forme T et meuble de service. Structure métallique blanche (RAL 9010) et plateau en mélamine blanche.



**POP TEE**

Scrivania con gamba a T e mobile di servizio. Struttura in metallo verniciato bianco (RAL 9010) e piano in melaminico bianco.

T-leg desk with service unit. White (RAL 9010) metal structure and white melamine top.

Bureau avec piétement de forme T et meuble de service. Structure métallique blanche (RAL 9010) et plateau en mélamine blanche.

Il concetto di funzionalità si esprime in un'unica struttura metallica tecnica ed essenziale.

The concept of functionality is expressed by a simple technical metal structure.

Le concept de fonctionnalité est résumé dans une structure métallique technique unique et essentielle.

**POP TEE**

Scrivania con gamba a T. Schermi divisorii rivestiti in tessuto Bondai - TBB2. Struttura in metallo verniciato bianco (RAL 9010) e piano in melaminico bianco.

T-leg desk. Screens upholstered in Bondai - TBB2 fabric. White (RAL 9010) metal structure and white melamine top.

Bureau avec piétement de forme T. Panneaux écran revêtus en tissu Bondai - TBB2. Structure métallique blanche (RAL 9010) et plateau en mélamine blanche.

**CLASSE 5 - EM59**

Seduta operativa / Task chair / Siège bureau Bondai - TBB2





**POP PANEL**

Scrivanie con allungo laterale.  
Struttura e piano in melaminico  
bianco.

L-shape desks with white  
melamine structure and top.

Bureaux avec retour latéral.  
Structure et plateau en mélamine  
blanche.



**POP PANEL**

Scrivanie con allungo laterale.  
Struttura e piano in melaminico  
bianco.

L-shape desks with white  
melamine structure and top.

Bureaux avec retour latéral.  
Structure et plateau en mélamine  
blanche.



**POP PANEL**

Scrivania con allungo laterale.  
Struttura e piano in melaminico  
noce canaletto.

L-shape desk with american  
walnut melamine structure and  
top.

Bureau avec retour latéral.  
Structure et plateau en mélamine  
noyer américain.



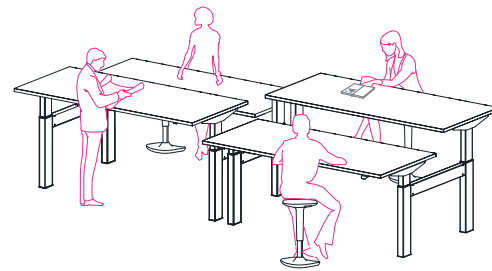
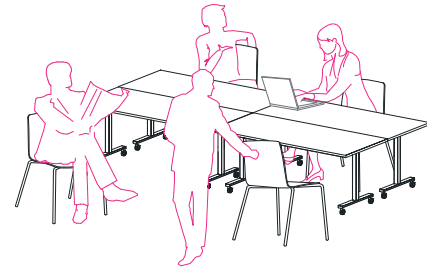
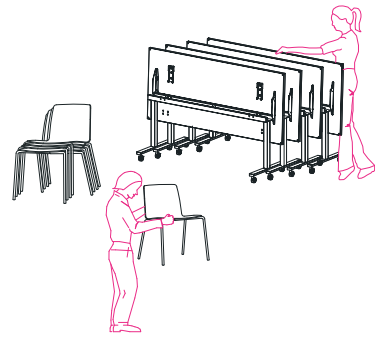

## dynamic work

POSTAZIONI DI LAVORO COMODE, PERSONALIZZATE ED ERGONOMICHE, ADATTE AD AMBIENTI DI LAVORO DINAMICI E INFORMALI. LE SCRIVANIE REGOLABILI IN ALTEZZA (O SIT STAND DESK) CONSENTONO DI PASSARE FACILMENTE DALLA POSIZIONE SEDUTA A QUELLA IN PIEDI.

COMFORTABLE, CUSTOMISED AND ERGONOMIC WORKSTATIONS SUITABLE FOR DYNAMIC AND INFORMAL WORKING ENVIRONMENTS. HEIGHT ADJUSTABLE DESKS (OR SIT STAND DESKS) ALLOW TO SHIFT EASILY FROM SEATED TO STANDING POSITIONS.

POSTES DE TRAVAIL CONFORTABLES, INDIVIDUELS ET ERGONOMIQUES, ADAPTÉS AUX ENVIRONNEMENTS DE TRAVAIL DYNAMIQUES ET INFORMELS. LES BUREAUX RÉGLABLES EN HAUTEUR (OU BUREAUX ASSIS-DEBOUT) PERMETTENT DE PASSER FACILEMENT DE LA POSITION ASSISE À LA POSITION DEBOUT.



#### POP AD

Scrivanie e bench elevabili in altezza 1 step (da 73 a 113 cm). Struttura in metallo verniciato bianco (RAL 9010) e piano in melaminico rovere.

1 step height-adjustable desks and bench desk from (73 to 113 cm). White (RAL 9010) metal structure and oak melamine top.

Bureaux et bureaux doubles réglables en hauteur 1 step (de 73 à 113 cm). Structure métallique blanche (RAL 9010) et plateau en mélamine chêne.

#### CLASSE 6 - EM60

Seduta operativa e sgabello  
Task chair and stool  
Siège bureau et tabouret  
King Flex - XFYD



Pop Ad è la soluzione ottimale di scrivania regolabile in altezza perché è facilmente personalizzabile. Pop Ad rende l'ambiente lavorativo un luogo intelligente e dinamico. Il sistema integrato sit-stand permette di passare dal lavorare seduti a in piedi promuovendo il benessere delle persone e le esigenze di flessibilità dei moderni ambienti di lavoro.

Pop Ad is the optimal height-adjustable desk solution because it can be easily customised. Pop Ad makes the working environment an intelligent and dynamic place. The integrated sit-stand system makes it possible to switch from a sitting position to a standing one while working, promoting people's well-being and the flexibility requirements of modern working environments.

Pop Ad est la solution optimale de bureau réglable en hauteur car il peut être facilement personnalisé. Pop Ad fait de l'environnement de travail un lieu intelligent et dynamique. Le système intégré assis-debout permet de passer du travail en position assise au travail debout, ce qui favorise le bien-être des personnes et les exigences de flexibilité des environnements de travail contemporains.





**POP AD**

Bench elevabili in altezza 2 steps (da 65 a 125 cm). Struttura in metallo verniciato bianco (RAL 9010) e piano in melaminico rovere.

2 steps height-adjustable bench desk (from 65 to 125 cm). White (RAL 9010) metal structure and oak melamine top.

Bueaux doubles réglables en hauteur 2 steps (de 65 à 125 cm). Structure métallique blanche (RAL 9010) et plateau en mélamine chêne.

**CLASSE 6 - EM60**

Seduta operativa e sgabello  
Task chair and stool  
Siège bureau et tabouret  
Rivet - T7G1



**POP AD**

Bench elevabili in altezza 2 steps (da 65 a 125 cm). Struttura in metallo verniciato bianco (RAL 9010) e piano in melaminico rovere.

2 steps height-adjustable bench desk (65 to 125 cm). White (RAL 9010) metal structure and oak melamine top.

Bureaux doubles réglables en hauteur 2 steps (65 à 125 cm). Structure métallique blanche (RAL 9010) et plateau en mélamine chêne.

**CLASSE 6 - EM60**

Seduta operativa / Task chair / Siège bureau  
Bondai - TBM1



**DETTAGLI TECNICI**

Technical data/Données techniques

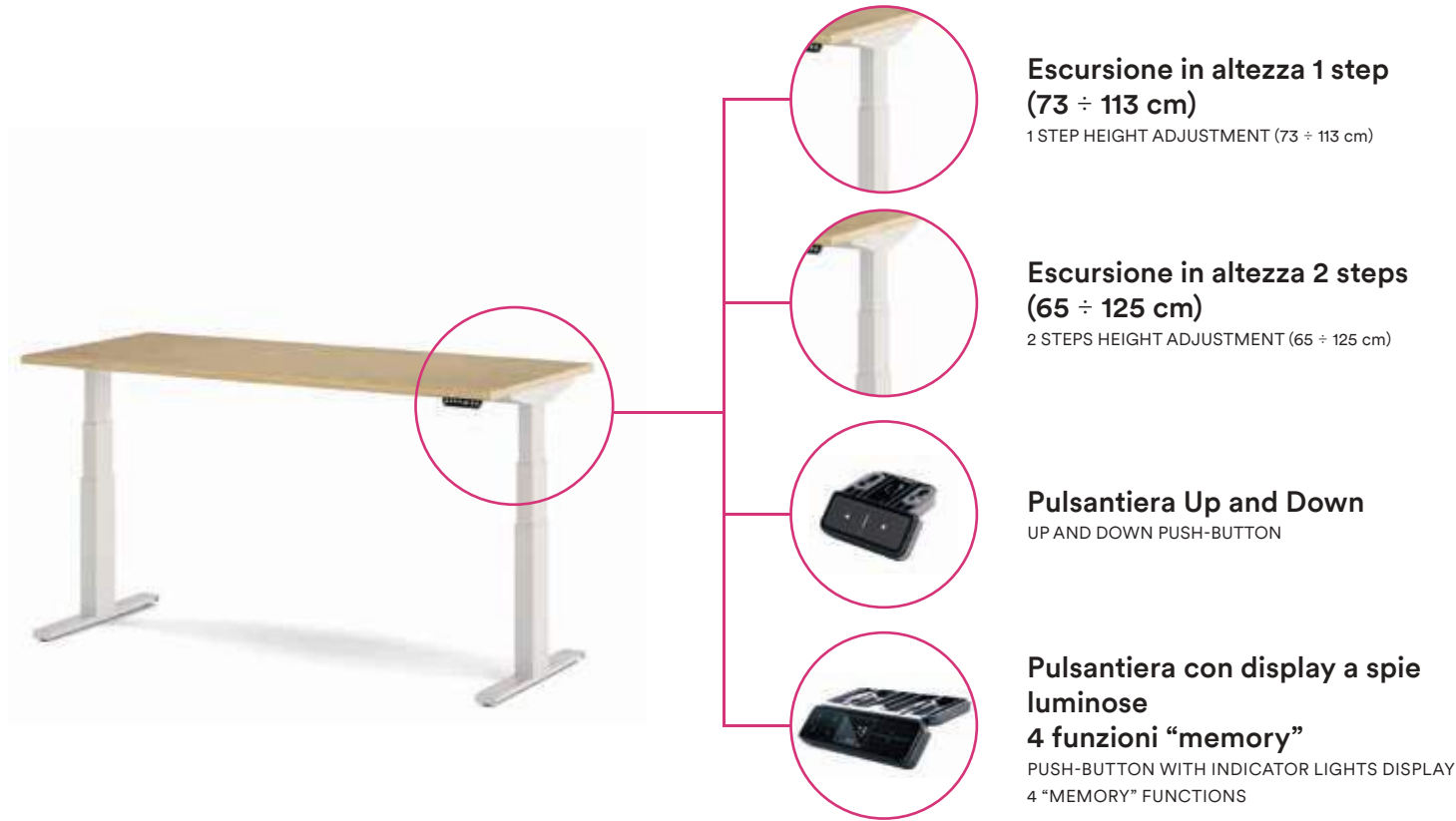

**Escursione in altezza 1 step  
(73 ÷ 113 cm)**

1 STEP HEIGHT ADJUSTMENT (73 ÷ 113 cm)

**Escursione in altezza 2 steps  
(65 ÷ 125 cm)**

2 STEPS HEIGHT ADJUSTMENT (65 ÷ 125 cm)

**Pulsantiera Up and Down**

UP AND DOWN PUSH-BUTTON

**Pulsantiera con display a spie  
luminose**

**4 funzioni "memory"**

PUSH-BUTTON WITH INDICATOR LIGHTS DISPLAY  
4 "MEMORY" FUNCTIONS







#### POP FOLDING

Tavolo ribaltabile su ruote.  
Struttura in metallo verniciato  
bianco (RAL 9010) e piano in  
melaminico rovere.

Folding table on castors. White  
(RAL 9010) metal structure and  
oak melamine top.

Table pliante sur roulettes.  
Structure métallique (RAL 9010)  
blanche et plateau en mélamine  
chêne.

#### YO

design Giacobone + Roj  
Progetto CMR  
Scocca / Unibody / Monocoque:  
rovere naturale - natural oak  
wood - chêne naturel  
Telaio a slitta / Cantilever frame /  
Piètement luge: blu pastello -  
pastel blue - bleu pastel  
(RAL 5024)



**POP FOLDING**

Tavolo ribaltabile su ruote. Struttura in metallo verniciato alluminio seta (RAL 9006) e piano in melaminico bianco.

Folding table on castors. Aluminium silk (RAL 9006) metal structure and white melamine top.

Table pliante sur roulettes. Structure métallique peinte en aluminium soie (RAL 9006) et plateau en mélamine blanche.

**YO**

design Giacobone + Roj Progetto CMR

Seduta multifunzione / Multipurpose chair /

Chaise polyvalente

Tessuto / Fabric / Tissu: Steelcut Trio 3 - SYRP

Telaio a slitta / Cantilever frame /

Piètement luge: Bianco / White / Blanc RAL 9010

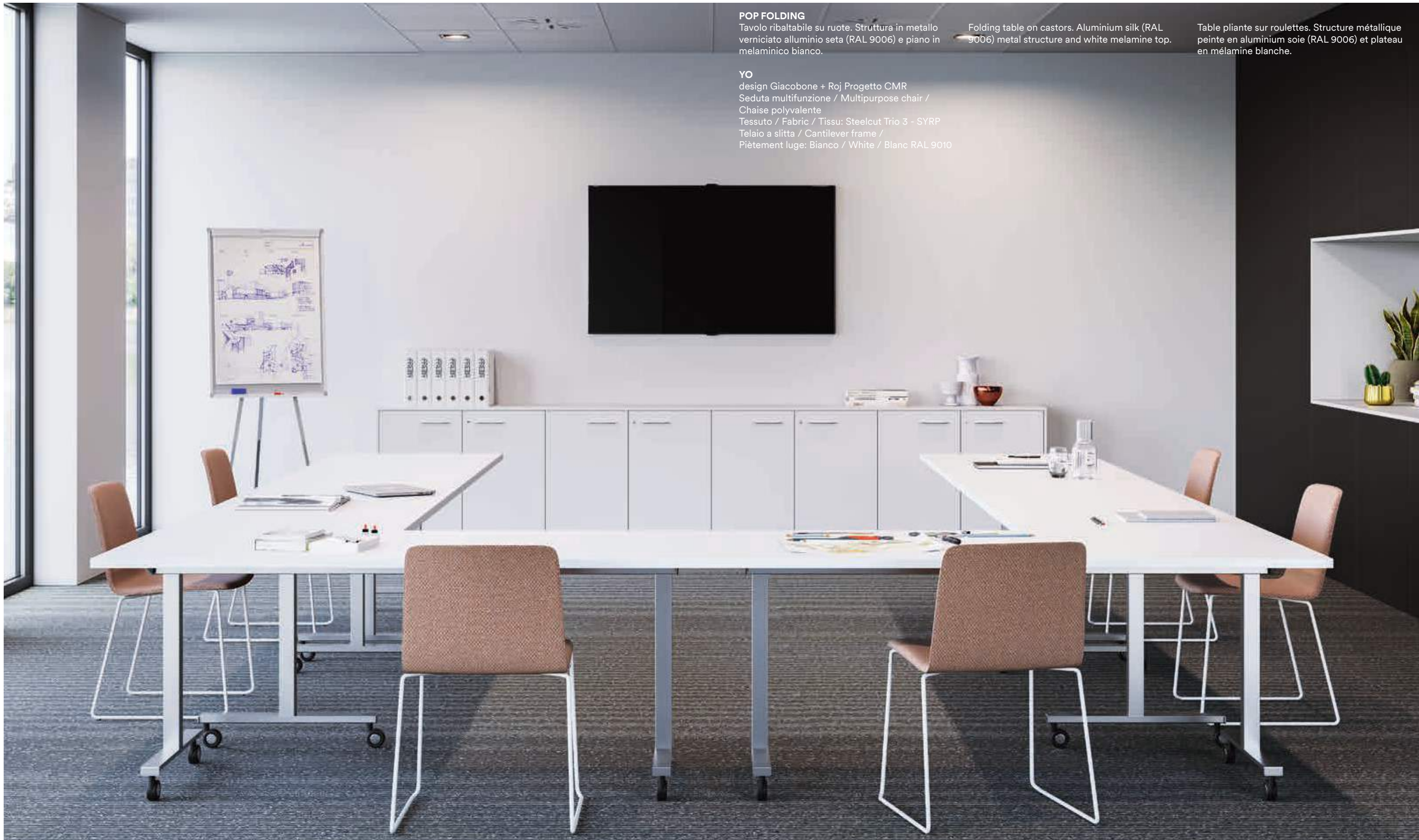



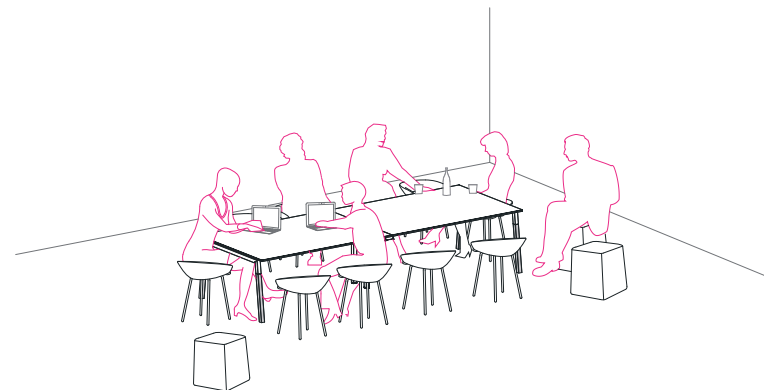
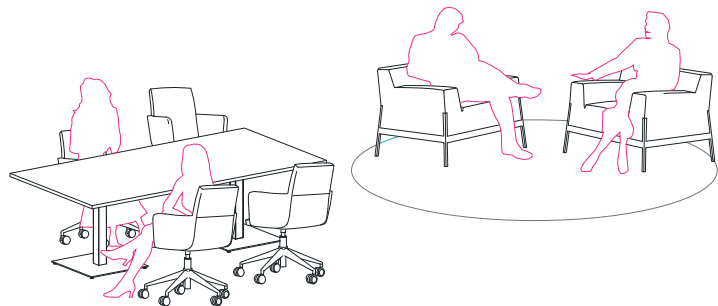
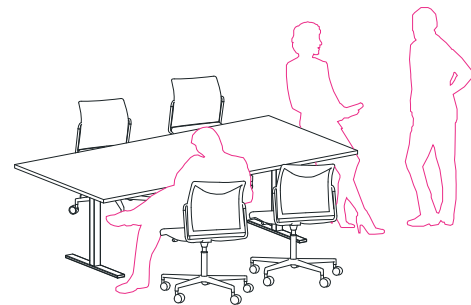
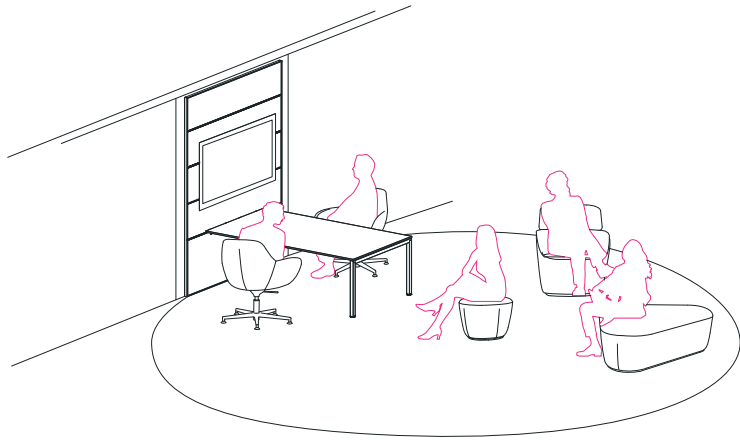
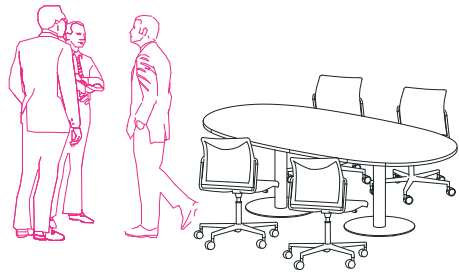

## meeting

I TAVOLI RIUNIONE POP SONO LA SCELTA FLESSIBILE E FUNZIONALE:  
UNA GAMMA COMPLETA CHE SODDISFA TUTTE LE ESIGENZE  
DELL'UFFICIO. I TAVOLI MEETING POP SONO PROPOSTI IN DUE  
ALTEZZE, 74 E 105 CM.

POP MEETING TABLES ARE THE FLEXIBLE AND FUNCTIONAL CHOICE  
FOR DYNAMIC MEETINGS. THE COMPLETE RANGE MEETS ALL THE  
OFFICE NEEDS. POP MEETING TABLES ARE PROPOSED IN TWO  
DIFFERENT HEIGHTS, 74 AND 105 CM.

LES TABLES RÉUNION POP SONT LE CHOIX FLEXIBLE ET  
FONCTIONNEL: UNE GAMME COMPLÈTE QUI RÉPOND À TOUS LES  
BESOINS DU BUREAU.  
LES TABLES RÉUNION POP SONT PROPOSÉES EN DEUX HAUTEURS, 74  
ET 105 CM.



**POP ACE**

Tavolo riunione L. 320 cm P. 125 cm H. 74 cm con struttura metallica finitura alluminio seta (RAL 9006) e piano melaminico bianco.

Meeting table W. 320 cm D. 125 cm H. 74 cm with aluminium silk (RAL 9006) metal structure and white melamine top.

Table réunion L. 320 cm P. 125 cm Ht. 74 cm avec structure métallique aluminium soie (RAL 9006) et plateau en mélamine blanche.

**YO**

design Giacobone + Roj Progetto CMR  
Seduta multifunzione / Multipurpose chair / Chaise polyvalente  
Tessuto / Fabric / Tissu: Remix 3 - RIRG  
Telaio 4 gambe / 4-leg frame / Bâti 4 pieds: Rosso / Red / Rouge RAL 3020

**POP ACE**

Tavolo riunione L. 140 cm P. 80 cm H. 105 cm con struttura metallica finitura alluminio seta (RAL 9006) e piano melaminico bianco.

Meeting table W. 140 cm D. 80 cm H. 105 cm with aluminium silk (RAL 9006) metal structure and white melamine top.

Table réunion L. 140 cm P. 80 cm Ht. 105 cm avec structure métallique finition aluminium soie (RAL 9006) et plateau en mélamine blanche.

**YO STOOL**

design Giacobone + Roj Progetto CMR  
Sgabello / Stool / Tabouret  
Tessuto / Fabric / Tissu: Remix 3 - RIRG  
Telaio a slitta / Cantilever frame / Piètement luge: Rosso / Red / Rouge RAL 3020





**POP WOODY**

Tavolo riunione modulare (P. 125 cm) con struttura in metallo verniciato nero (RAL 9005) e gamba in frassino naturale verniciato trasparente. Piano in melaminico bianco.

Modular meeting table (D. 125 cm) with black metal structure (RAL 9005) and leg in natural ash, clear varnished. White melamine top.

Table de réunion modulaire (P. 125 cm) avec structure métallique noire (RAL 9005) et piétement en frêne naturel verni transparent. Plateau en mélamine blanche.

**YO**

design Giacobone + Roj Progetto CMR  
Seduta multifunzione / Multipurpose chair / Chaise polyvalente  
Tessuto / Fabric / Tissu: Era - T8G1, T8R2, R8B0  
Telaio 4 gambe / 4-leg frame / Bâti 4 pieds:  
Nero / Black / Noir RAL 9005



Tavoli riunione modulari, proposti sia in forma quadrata che rettangolare, si prestano per sale meeting informali. Con diverse soluzioni di cablaggio.

Modular meeting tables, both square and rectangular in shape, are suitable for informal meeting rooms. They come with different wiring solutions.

Les tables de réunion modulaires, disponibles en formes carrées et rectangulaires, conviennent aux salles de réunion informelles. Avec différentes solutions de câblage.

**YO**

design Giacobone + Roj Progetto CMR  
Seduta multifunzione / Multipurpose chair / Chaise polyvalente  
Tessuto / Fabric / Tissu: Era - T8R3  
Telaio 4 gambe / 4-leg frame / Bâti 4 pieds:  
Bianco / White / Blanc RAL 9010





**POP EASY**

Tavolo riunione modulare con struttura in metallo verniciato nero (RAL 9005) e piano in melaminico noce canaletto.

Modular meeting table with black (RAL 9005) metal structure and american walnut melamine top.

Table de réunion modulaire avec structure métallique noire (RAL 9005) et plateau en mélamine noyer américain.

**FIOR DI LOTO**

design C. Bellini  
Seduta multifunzione  
Multipurpose chair  
Siège polyvalent

Tessuto / Fabric / Tissu:  
Era - T8R1





**POP PANEL**

Tavolo riunione con piano e struttura in melaminico noce canaletto.

Meeting table with american walnut melamine top and structure.

Table de réunion avec plateau et structure en mélamine noyer américain.



**POP TEE**

Tavolo riunione con struttura a due colonne in metallo bianco (RAL 9010) e piano ovale in melaminico bianco.

Meeting table with 2-column white (RAL 9010) metal structure and white melamine oval top.

Table de réunion avec structure à deux colonnes en métal blanc (RAL 9010) et plateau ovale en mélamine blanche.



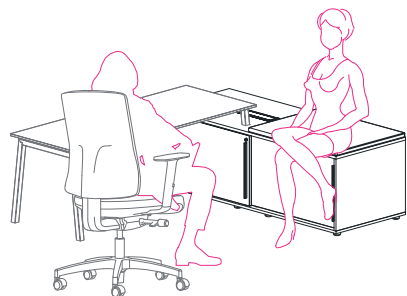
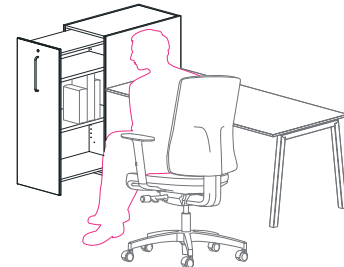
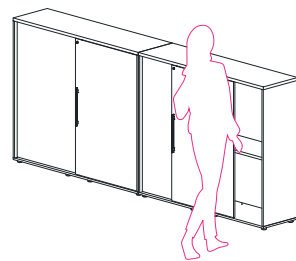
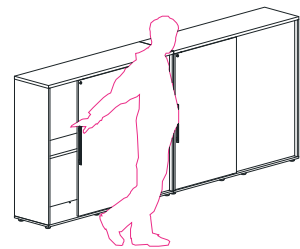
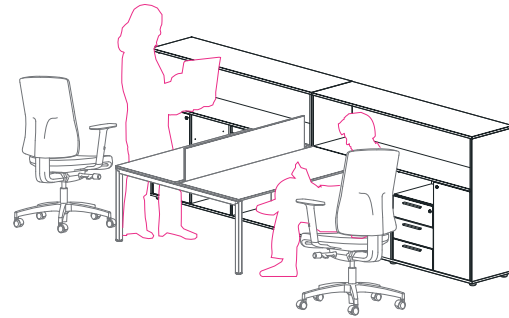
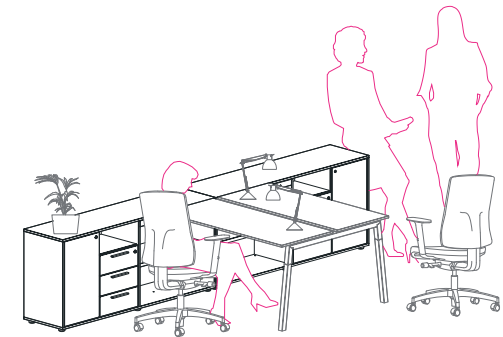
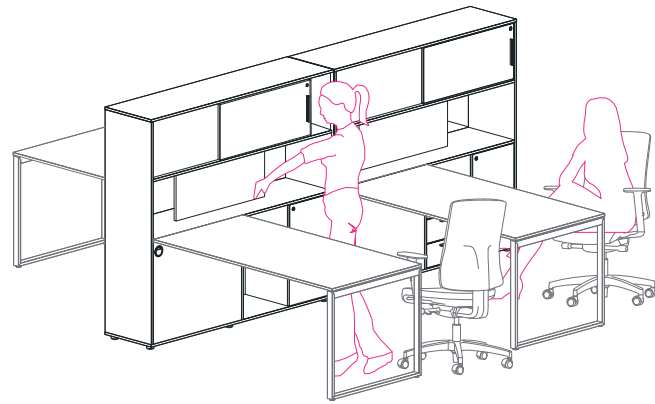

## organized workspace

ORGANIZZARE IL PROPRIO SPAZIO DI LAVORO. CONTENITORI, CASSETTI E LIBRERIE RAPPRESENTANO LA SOLUZIONE PIÙ EFFICIENTE PER OTTIMIZZARE ED ORGANIZZARE AL MEGLIO LA POSTAZIONE DI LAVORO. DIVERSE PROPOSTE DI ARCHIVIAZIONE CHE RISPONDONO A OGNI ESIGENZA, AGGIUNGO VALORE ESTETICO ED AUMENTANO IL PROPRIO SPAZIO DI LAVORO.

ORGANISING ONE'S OWN WORK SPACE IS AN IMPORTANT TASK. STORAGE UNITS, DRAWERS AND SHELVING ARE THE MOST EFFICIENT WAY TO OPTIMISE AND ORGANISE A WORKSPACE. DIFFERENT STORAGE PROPOSALS MEET DIFFERENT NEEDS, ADD SPECIFIC AESTHETIC VALUES AND ENHANCE YOUR WORKSPACE.

ORGANISER VOTRE ESPACE DE TRAVAIL. LES MEUBLES DE RANGEMENT, LES CAISSONS ET LES LIBRAIRIES SONT LE MOYEN LE PLUS EFFICACE D'OPTIMISER ET D'ORGANISER VOTRE ESPACE DE TRAVAIL. IL EXISTE DIFFÉRENTES OPTIONS DE RANGEMENT QUI RÉPOND À TOUS LES BESOINS, D'AJOUTER UNE VALEUR ESTHÉTIQUE ET D'AUGMENTER L'ESPACE UTILE DE TRAVAIL.





**CABINETS H. 114**

Armadi L. 165 cm con anta battente, vani a giorno inferiori con schiena in melaminico. Vano a giorno superiore con schiena rivestita in tessuto.

165 cm wide cabinets with hinged door, open lower unit with melamine back. Open upper unit with fabric covered back.

Armoires L. 165 cm avec porte battante, compartiments inférieurs ouverts, avec fond en mélamine. Compartiment supérieur ouvert avec fond revêtu en tissu.

**CLASSE 4 - EM49**

Seduta operativa / Task chair / Siège bureau

Rete / Mesh / Résille: Polo - RPZO

Tessuto / Fabric / Tissu:

Bondai - TBBE





La collezione di armadi per ufficio offre diverse soluzioni e configurazioni per la gestione dell'archiviazione in ufficio. Armadi ad altezza scrivania proposti con ante battenti o scorrevoli, cassettiere, moduli a giorno e ripiani da utilizzare come libreria. Disponibili in tre altezze.

The office cabinet collection offers various solutions and configurations for office space management. Desk-height cabinets with hinged or sliding doors, pedestals, open units and shelves used as bookcases are available in three heights.

La collection d'armoires offre différentes solutions et configurations pour organiser le rangement au bureau. Des armoires à hauteur de bureau avec des portes battantes ou coulissantes, des caissons, des unités ouvertes et des étagères à utiliser comme bibliothèques. Trois hauteurs disponibles.

#### CABINETS H. 154 cm

Armadi L. 165 cm con 1 anta battente e cassetiera 3 cassetti, vano a giorno superiore con schiena rivestita in tessuto. Vano terzo livello con ante scorrevoli e serratura integrata.

Cabinets W. 165 cm with 1 hinged door and 3 drawer pedestal, upper open compartment with fabric upholstered back. Third level compartment with sliding doors and integrated lock.

Armoires L. 165 cm avec 1 porte battante et caisson avec 3 tiroirs, compartiment supérieur ouvert avec fond revêtu en tissu. Compartiment troisième niveau avec portes coulissantes et serrure intégrée.

#### FIOR DI LOTO

design C. Bellini  
Seduta multifunzione con carter retro schienale in plastica Baydur.  
Step - TBB6

Multipurpose chair with rear side of backrest in Baydur plastic.

Siège polyvalent avec arrière du dossier en plastique Baydur.





**WORKWALL**

Boiserie H. 195 cm con modulo contenitore (L. 140 cm) con apertura verso l'alto. Pannelli in melaminico rovere e rivestiti in tessuto.

Boiserie H. 195 cm with 140 cm wide storage modules opening upwards. Oak melamine and upholstered fabric panels.

Boiserie Ht. 195 cm avec conteneur L. 140 cm avec ouverture vers le haut. Panneaux en mélamine chêne et revêtus en tissu.

**CLASSE 4 - EM49**

Seduta operativa / Task chair / Siège bureau  
 Rete / Mesh / Résille: Polo - RPZO  
 Tessuto / Fabric / Tissu: Bondai - TBB2

**WORKWALL**

Boiserie H. 195 cm con moduli contenitori L. 160 cm con apertura verso l'alto. Pannelli in melaminico cemento e rivestiti in tessuto.

Boiserie H. 195 cm with 160 cm wide storage modules opening upwards. Concrete texture melamine and upholstered fabric panels.

Boiserie Ht. 195 cm avec conteneurs suspendus L. 160 cm et ouverture vers le haut. Panneaux en mélamine béton et revêtus en tissu.

**CLASSE 4 - EM49**

Seduta operativa / Task chair / Siège bureau  
 Rete / Mesh / Résille: Polo - RPG1  
 Tessuto / Fabric / Tissu: Boss FR - T4V1







Alla boiserie si possono agganciare scrivanie, mensole e contenitori pensili a giorno, con anta battente, a ribalta e con apertura verso l'alto.

**CLASSE 4 - EM49**

Seduta operativa / Task chair / Siège bureau  
 Rete / Mesh / Résille: Polo - RPG1  
 Tessuto / Fabric / Tissu: Boss FR - T4V1

The boiserie can be equipped with desks, shelves, open hanging units, hanging units that open upwards or hanging units with a hinged or flap door.

La boiserie peut être équipée avec bureaux, étagères, éléments suspendu ouvertes, éléments suspendus avec portes battantes, ou porte à rabat, ou avec ouverture parallèle vers le haut.





**CABINETS H. 56 cm**  
Mobile di servizio portante L. 165 cm con ante scorrevoli.

Supporting service cabinets W. 165 cm with sliding doors.

Meuble de service portant L. 165 cm avec portes coulissantes.

**FIOR DI LOTO**  
design C. Bellini  
Seduta multifunzione con carter retro schienale in plastica Baydur.

Multipurpose chair with rear side of backrest in Baydur plastic.

Siège polyvalent avec arrière du dossier en plastique Baydur.

Step - STSB



**mobili di servizio:** la praticità di utilizzare il mobile di servizio sia come seduta che elemento di archiviazione. Ogni mobile ha un vano interno predisposto per la salita cavi.

**service cabinets:** because of their double function (both as a seat and as a filing element), service cabinets have a great potential. Each cabinet has an inner compartment where cables can be put.

**meuble de service:** la praticité d'utiliser le meuble de service comme un siège et un élément de rangement. Chaque meuble a un compartiment interne conçu pour l'entrée.



**Nel sistema scrivanie pop si integrano diverse tipologie di contenitori quali cassettiere, orgatower e armadi studiati come elementi salvaspazio.**

DIFFERENT PIECES OF FURNITURE CAN COMPLETE THE OFFER OF THE POP DESKS: PEDESTALS, ORGATOWER AND CABINETS DESIGNED AS SPACE-SAVING ELEMENTS.

DANS LE SYSTÈME POP SONT INTÉGRÉS DIFFÉRENTS TYPES DE CONTENEURS TELS QUE DES TIROIRS, DES ORGATOWER ET DES ARMOIRES CONÇUES COMME DES ÉLÉMENTS PEU ENCOMBRANTS.







**orgatower:** crea uno spazio adatto a riporre ed archiviare in aree ridotte. Proposto con diversi accessori.

**orgatower:** this element creates space for storage and filing in small areas. Available with different accessories.

**orgatower:** crée un espace adapté au rangement et à l'archivage dans les petites zones. Disponible avec différents accessoires.



**orgatower:** configurabile con diversi accessori come telai estraibili per il supporto di cartelle sospese, cassetto estraibile oppure ripiani per l'archiviazione.

**orgatower:** configurable with different accessories such as pull-out frames to support hanging folders, pull-out drawers or shelves for storage.



**orgatower:** configurable avec différents accessoires tels que des châssis télescopiques pour supporter des dossiers suspendus, des tiroirs télescopiques ou des étagères pour l'archivage.



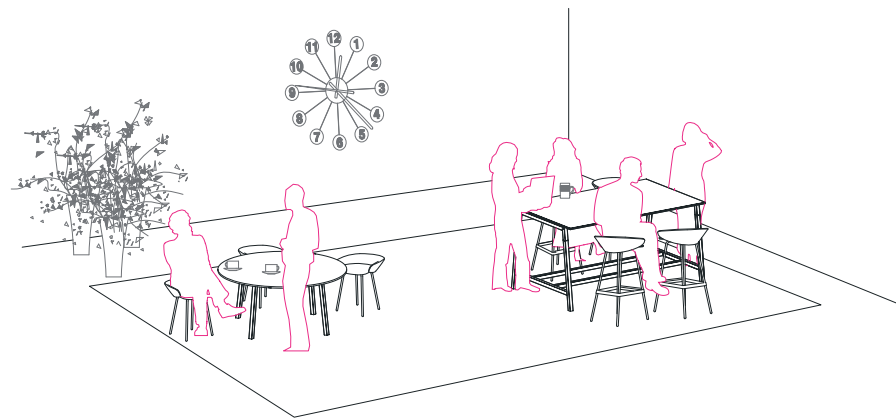
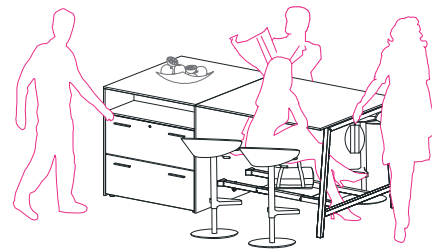
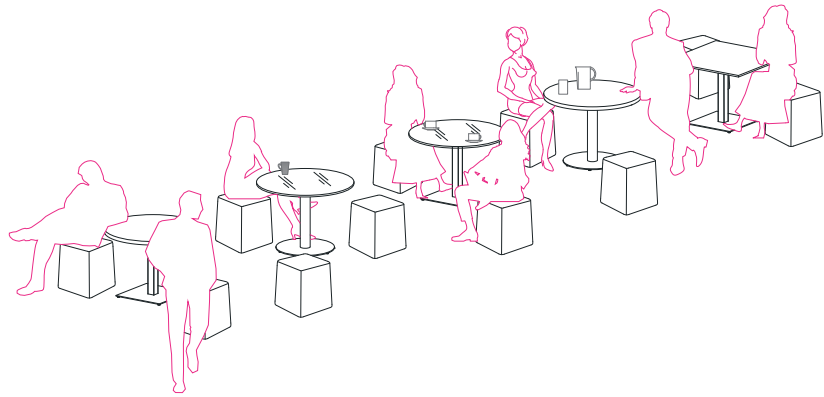
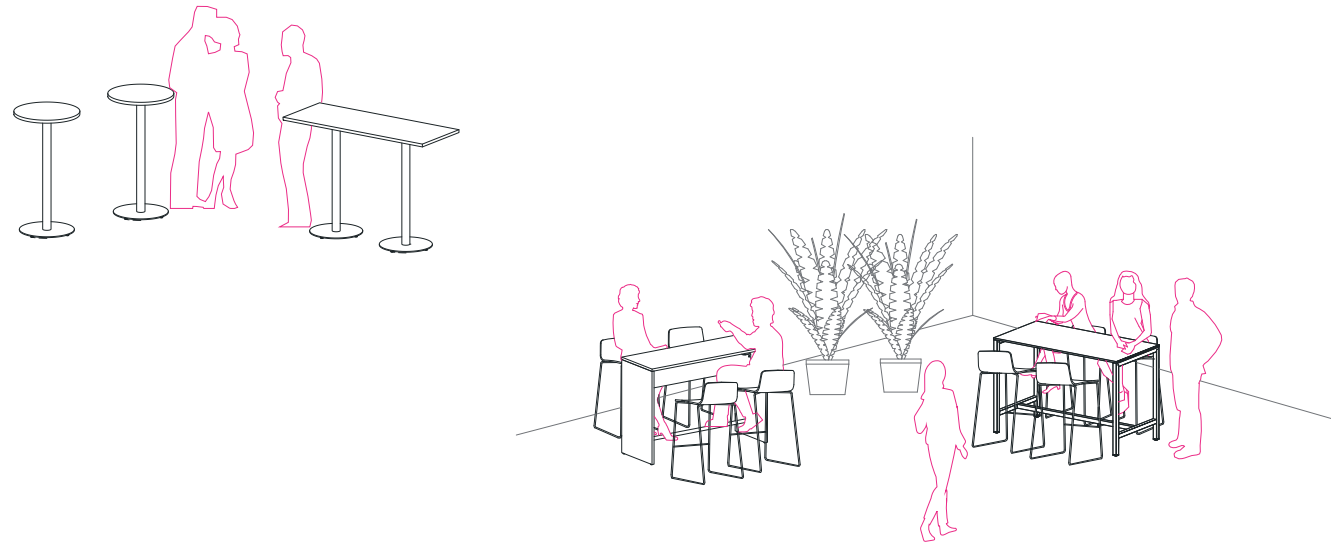

## break out

LA COLLABORAZIONE E LA CONDIVISIONE DI IDEE SONO ALLA BASE DELLA PRODUTTIVITÀ. L'AREA BREAK OUT È IL LUOGO IN CUI I DIPENDENTI SI INCONTRANO, LAVORANO E SOCIALIZZANO. È UN'AREA STRATEGICA CHE TRASFORMA IL LUOGO DI LAVORO PER IL BENESSERE DELL'INDIVIDUO.

COLLABORATING AND SHARING IDEAS ARE THE BASIS OF PRODUCTIVITY. THE BREAK OUT AREA IS THE PLACE WHERE EMPLOYEES MEET, WORK AND SOCIALISE. IT'S A STRATEGIC AREA THAT TRANSFORMS THE WORKPLACE FOR THE WELL-BEING OF THE PEOPLE.

LA COLLABORATION ET LE PARTAGE DES IDÉES SONT LA BASE DE LA PRODUCTIVITÉ. L'ESPACE DE DÉTENTE EST LE LIEU DE RENCONTRE, DE TRAVAIL ET DE SOCIALISATION DES EMPLOYÉS. ELLE EST UNE ZONE STRATÉGIQUE QUI TRANSFORME LE LIEU DE TRAVAIL POUR LE BIEN-ÊTRE DE L'INDIVIDU.

**POP ACE**

Tavoli alti H. 105 cm, P. 80/125 cm con struttura in metallo verniciato bianco (RAL 9010) e piano in melaminico bianco.

High tables H. 105 cm, D. 80/125 cm with white metal structure (RAL 9010) and white melamine top.

Tables hautes Ht. 105 cm, P. 80/125 cm avec structure métallique blanche (RAL 9010) et plateau en mélamine blanche.

**KARL**

design L. Nichetto

Sgabello / Stool / Tabouret

Tessuto / Fabric / Tissu: Steelcut Trio 3 - SIRE







Postazioni agili e flessibili che si declinano in tavoli alti e in tavoli multifunzione completi di contenitori per lavorare in team e fare piccole pause relax. Un approccio ideale per aree di condivisione e informali.

**POP ACE**

Tavolo alto H. 105 cm, P. 125 cm con struttura in metallo verniciato nero (RAL 9005) e piano in melaminico noce canaletto.

**YO STOOL**

design Giacobone + Roj Progetto CMR  
Sgabello / Stool / Tabouret  
Tessuto / Fabric / Tissu: Remix 3 - RIGC, RIRB, RIRG

Agile and flexible workstations in the form of high tables and multifunctional tables with containers allow to work as a team and have a small relaxing breaks. An ideal solution for sharing and informal areas.

High table H. 105 cm, D. 125 cm with black (RAL 9005) metal structure and american walnut melamine top.

Poste de travail agiles et flexibles sous forme de tables hautes et de tables multifonctionnelles complète avec des armoires qui permettent de travailler en équipe et bénéficier de petites pauses relaxantes. Une approche idéale pour les espaces informels et à partager.

Table haute Ht. 105 cm, P. 125 cm avec structure métallique noire (RAL 9005) et plateau en mélamine noyer américain.



**POP WOODY**

Tavolo alto H. 105 cm, P. 125 cm con struttura in metallo verniciato bianco (RAL 9010) e gambe in frassino naturale verniciato trasparente. Piano e contenitori in melaminico bianco.

High table H. 105 cm, D. 125 cm with white metal structure (RAL 9010) and leg in natural ash, clear varnished. White melamine top and cabinets.

Table haute Ht. 105 cm, P. 125 cm avec structure métallique blanche (RAL 9010) et piétement en frêne naturel verni transparent. Plateau et cabinets en mélamine blanche.

**KARL**

design L. Nichetto  
Sgabello / Stool / Tabouret  
Tessuto / Fabric / Tissu: Remix 3 - RIRB, RIYE





**POP TABLES**  
Tavoli alti H. 105 cm, P. 60 cm con  
struttura e piano in melaminico  
bianco.

High tables H. 105 cm, D. 60 cm  
with white melamine structure  
and top.

Tables hautes Ht. 105 cm, P. 60  
cm avec structure et plateau en  
mélamine blanche.

**KARL**  
design L. Nichetto  
Sgabello / Stool / Tabouret  
Tessuto / Fabric / Tissu:  
Skill - PGCG





**POP TABLES**

Tavolo alto H. 105 cm, P. 60 cm con struttura in metallo verniciato bianco (RAL 9010) e piano in melaminico bianco.

High table H. 105 cm, D. 60 cm with white (RAL 9010) metal structure and white melamine top.

Table haute Ht. 105 cm, P. 60 cm avec structure métallique blanche et plateau en mélamine blanche.

**KARL**

design L. Nichetto  
Sgabello / Stool / Tabouret  
Tessuto / Fabric / Tissu:  
Steelcut Trio 3 - SYMA

**POP TABLES**

Tavolo alto H. 105 cm, Ø 60 cm con struttura in metallo verniciato bianco (RAL 9010) e piano circolare in melaminico bianco.

Tavolo alto H. 105 cm, P. 60 cm con struttura e piano in melaminico bianco.

High table H. 105 cm, Ø 60 cm with white metal structure (RAL 9010) and white melamine round top.

High table H. 105 cm, D. 60 cm with white melamine structure and top.

Table haute Ht. 105 cm, Ø 60 cm avec structure métallique blanche (RAL 9010) et plateau circulaire en mélamine blanche.

Table haute Ht. 105 cm, P. 60 cm avec structure et plateau en mélamine blanche.

**KARL**

design L. Nichetto  
Sgabello / Stool / Tabouret  
Tessuto / Fabric / Tissu: Jet - JTR1, JTC1





**POP TABLES**

Tavoli regolabili in altezza (88<125 cm) su ruote con struttura metallica finitura cromo lucido e piano circolare (Ø 60 cm) in melaminico bianco.

Height-adjustable tables (88<125 cm) on castors with polished chrome metal structure and white melamine round top (Ø 60 cm).

Tables réglables en hauteur (88<125 cm) sur roulettes avec structure en métal chrome poli et plateau rond (Ø 60 cm) en mélamine blanche.

**KARL**

design L. Nichetto  
Sgabello / Stool / Tabouret  
Tessuto / Fabric / Tissu: Era - T8V8

**RADAR**

design Claesson, Koivisto, Rune  
Poltrona / Armchair / Fauteuil  
Tessuto / Fabric / Tissu: Era - T8BA

**POP TABLES**

Tavoli regolabili in altezza (75<113 cm) con struttura metallica finitura cromo lucido e piano circolare (Ø 60 cm) in melaminico bianco.

Height-adjustable tables (75<113 cm) with polished chrome metal structure and white melamine round top (Ø 60 cm).

Tables réglables en hauteur (75<113 cm) avec structure en métal chromé poli et plateau rond (Ø 60 cm) en mélamine blanche.

**YO**

design Giacobone + Roj  
Progetto CMR

Seduta multifunzione con monoscocca in rovere naturale.

Multipurpose chair with natural oak unibody.

Chaise polyvalente avec mono-coque en chêne naturel.





**POP ACE**  
Tavoli circolari con struttura in metallo bianco (RAL 9010) e piano in melaminico rovere con netbox point integrato.  
**YO**  
design Giacobone + Roj Progetto CMR  
Seduta multifunzione / Multipurpose chair  
Chaise polyvalente

Round tables with white (RAL 9010) metal structure and oak melamine top with netbox point included.

Tessuto / Tissu / Fabric:  
Remix 3 - RIB1

Tables rondes avec structure en métal blanc (RAL 9010) et plateau en mélamine chêne avec netbox point intégré.

Telaio a 4 gambe / 4-leg frame / Bâti 4 pieds:  
Blu pastello / Pastel blu / Bleu pastel RAL 5024



**POP TABLE**  
Tavolo circolare con struttura a colonna in metallo bianco (RAL 9010) e piano in melaminico rovere.

**YO**  
design Giacobone + Roj Progetto CMR  
Seduta multifunzione con monoscoeca in rovere sbiancato.

Round table with white (RAL 9010) metal column structure and oak melamine top.

Multipurpose chair with whitened oak unibody.

Table ronde avec structure à colonne en métal blanc (RAL 9010) et plateau en mélamine chêne.

Chaise polyvalente avec monocoque en chêne blanchi.





Tavoli multifunzione disponibili in varie forme, dimensioni e colorimetrie. In opzione, possibilità di elettrificare la colonna centrale.

Multifunctional tables available in various shapes, sizes and colours. The column can be equipped with cable management.

Tables multifonctionnelles disponibles en différentes formes, tailles et couleurs. Électrification facultative de la colonne centrale.

#### POP TABLES

Tavolo circolare con struttura a colonna in metallo nero (RAL 9005) e piano in vetro nero.  
Tavolo circolare con struttura a colonna in metallo bianco (RAL 9010) e piano in melaminico tortora.  
Tavolo quadrato con struttura a colonna in metallo nero (RAL 9005) e piano in melaminico noce canaletto.

Round table with black (RAL 9005) metal column structure and black glass top.  
Round table with white (RAL 9010) metal column structure and dove melamine top.  
Square table with black (RAL 9005) metal column structure and american walnut melamine top.

Table circulaire avec structure à colonne en métal noir (RAL 9005) et plateau en verre noir.  
Table circulaire avec structure à colonne en métal blanc (RAL 9010) et plateau en mélamine gris taupe.  
Table carré avec structure à colonnes en métal noir (RAL 9010) et plateau en mélamine noyer américain.



I tavoli Pop regolabili in altezza uniscono tutti i vantaggi del moderno concetto di high desking, sono infatti ideali per il lavoro agile in team o come punto di incontro per la comunicazione. Un'altezza regolabile che va da 75 cm a 113 cm per la versione con base fissa, e da 88 cm a 125 cm per la versione con ruote.

The height-adjustable Pop tables combine all the advantages of the modern high desking concept and are ideal for agile teamwork or as a meeting point for communication. The fixed version has an adjustable height that goes from 75 cm to 113 cm, while the version on castors can go from 88 cm to 125 cm.

Les tables Pop réglables en hauteur combinent tous les avantages du concept moderne de bureau en hauteur et sont idéales pour un travail d'équipe agile ou comme point de rencontre pour la communication. Avec une hauteur réglable de 75 cm à 113 cm pour la version base fixe, et de 88 cm à 125 cm pour la version à roulettes.

#### POP TABLES

Tavoli circolari elevabili in altezza con struttura a colonna in metallo bianco (RAL 9010) e piano in melaminico rovere.

Height-adjustable round tables with white (RAL 9010) metal column structure and oak melamine top.

Tables circulaires réglables en hauteur avec structure à colonne en métal blanc (RAL 9010) et plateau en mélamine chêne.



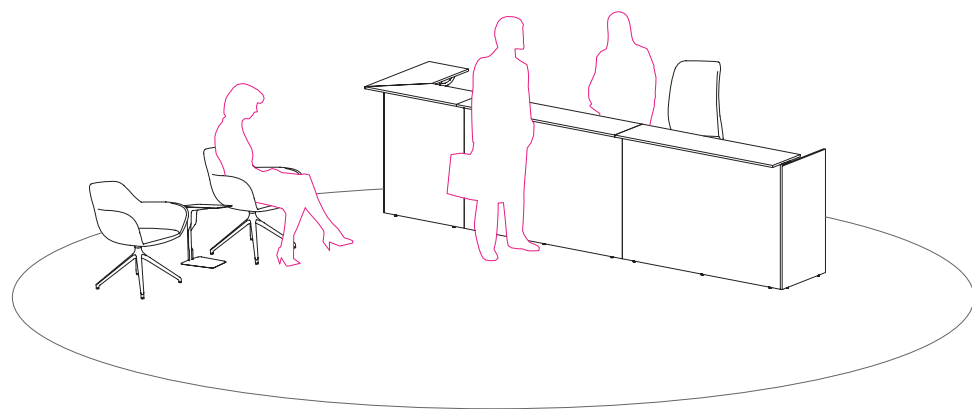
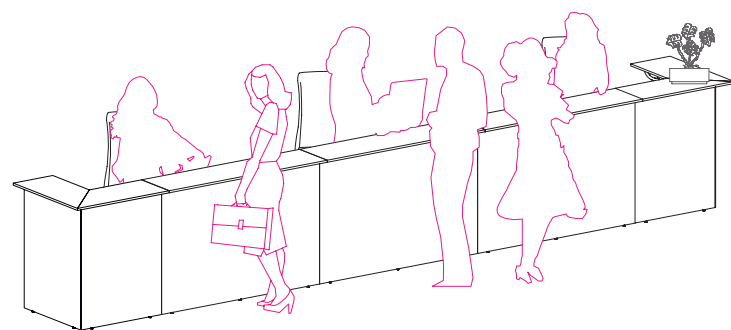
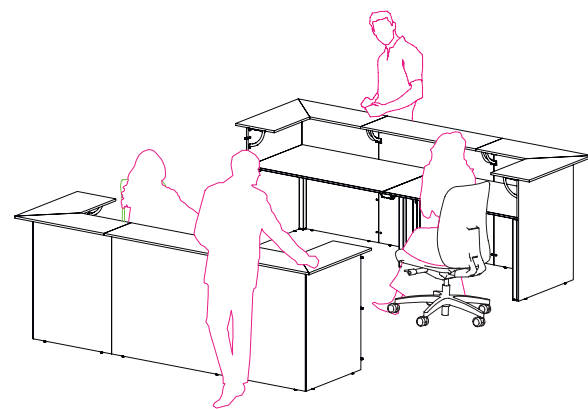

## welcome

NELLA PROGETTAZIONE DI UN UFFICIO MODERNO,  
ANCHE I DETTAGLI PARLANO DELL'AZIENDA, COMUNICANO IL  
BRAND E I SUOI VALORI.

WHEN DESIGNING A MODERN OFFICE ALL ELEMENTS MUST  
COMMUNICATE THE COMPANY'S BRAND AND VALUES.

DANS LA CONCEPTION D'UN BUREAU MODERNE, MÊME LES  
DÉTAILS RACONTENT L'ENTREPRISE, COMMUNIQUENT LA MARQUE  
ET SES VALEURS.





**BAGUETTE**

Reception modulare in  
melaminico bianco.

White melamine modular  
reception.

Banque d'accueil modulaire en  
mélamine blanche.



**BAGUETTE**  
Reception modulare in  
melaminico bianco.  
White melamine modular  
reception.  
Banque d'accueil modulaire en  
mélamine blanche.



**BAGUETTE**  
Reception modulare in  
melaminico bianco.  
White melamine modular  
reception.  
Banque d'accueil modulaire en  
mélamine blanche.

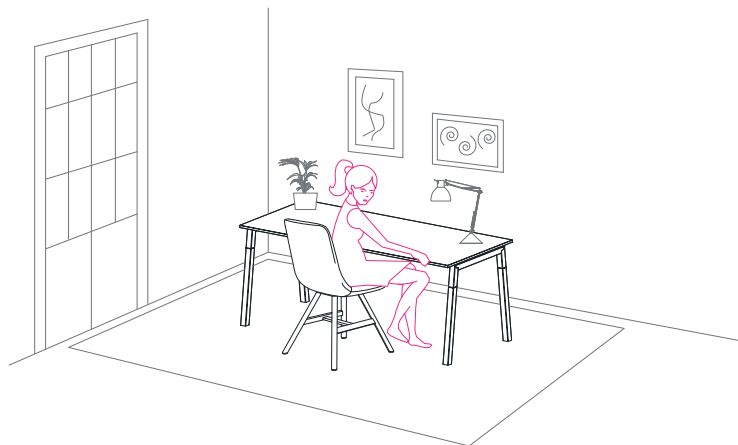

## home

IN UN'EPOCA DI CRESCENTE LAVORO A DISTANZA, DIVENTA ANCORA PIÙ IMPORTANTE CREARE E INCORAGGIARE UNA FORTE CULTURA DI SQUADRA. L'ARREDAMENTO, LA TECNOLOGIA E IL DESIGN POSSONO GIOCARE UN RUOLO SOSTANZIALE NEL RENDERE IL LAVORO A DISTANZA PIÙ FLUIDO.

AS REMOTE WORKING INCREASES, CREATING AND FOSTERING A STRONG TEAM CULTURE BECOMES EVEN MORE IMPORTANT. FURNITURE, TECHNOLOGY AND ENVIRONMENT DESIGN CAN PLAY A SUBSTANTIAL ROLE IN MAKING REMOTE WORKING MORE FLUID.

À UNE ÉPOQUE OÙ LE TRAVAIL À DISTANCE SE DÉVELOPPE, IL DEVIENT ENCORE PLUS IMPORTANT DE CRÉER ET D'ENCOURAGER UNE CULTURE D'ÉQUIPE FORTE. LE MOBILIER, LA TECHNOLOGIE ET LA CONCEPTION DE L'ENVIRONNEMENT PEUVENT JOUER UN RÔLE IMPORTANT POUR RENDRE LE TRAVAIL À DISTANCE PLUS FLUIDE.





**POP ACE**

Scrivania P. 60 cm. Struttura in metallo verniciato bianco (RAL 9010) e piano in melaminico rovere.

Desk D. 60 cm. White metal structure (RAL 9010) and oak melamine top.

Bureau P. 60 cm. Structure métallique blanche (RAL 9010) et plateau en mélamine chêne.

**CLASSE 4 - EM46**

Seduta operativa / Task chair / Siège bureau  
Rete / Mesh / Résille: Polo - RPG1  
Tessuto / Fabric / Tissu: Jet - JTH2



**POP WOODY**

Scrivania P. 60 cm con struttura in metallo verniciato bianco (RAL 9010) e gamba in frassino naturale verniciato trasparente. Piano in melaminico bianco.

Desk D. 60 cm with white (RAL 9010) metal structure and leg in natural ash, clear varnished. White melamine top.

Bureau P. 60 cm avec structure métallique blanche (RAL 9010) et piétement en frêne naturel verni transparent. Plateau en mélamine blanche.

**CLASSE 4 - EM46**

Seduta operativa / Task chair / Siège bureau  
Rete / Mesh / Résille: Polo - RPZ0  
Tessuto / Fabric / Tissu: Jet - JTW2

When Nothing Goes Right, Go Left.

When Nothing Goes Right, Go Left.

When Nothing Goes Right, Go Left.





**POP SQUARE**

Scrivania con cassetteria ad altezza scrivania. Struttura in metallo verniciato bianco (RAL 9010) e piano in melaminico bianco.

Desk with desk-height pedestal. White (RAL 9010) metal structure and white melamine top.

Bureau avec caisson ht bureau. Structure métallique blanche (RAL 9010) et plateau en mélamine blanche.

**CLASSE 4 - EM46**

Seduta operativa / Task chair / Siège bureau  
Rete / Mesh / Résille: Polo - RPZO  
Tessuto / Fabric / Tissu: Jet - JTC1



**POP AD**

Scrivania elevabile in altezza 1 step (da 73 a 133 cm). Struttura bianca (RAL 9010) e piano in melaminico rovere.

1 step height-adjustable desk (from 75 to 113 cm). White (RAL 9010) metal structure and oak melamine top.

Bureau réglable en hauteur 1 step (de 73 à 113 cm). Structure métallique blanche (RAL 9010) et plateau en mélamine chêne.

**DEVA**

Seduta direzionale / Executive chair / Siège direction: Boss FR - T4M0







# DETTAGLI TECNICI

Technical data/Données techniques

## per scrivania

FOR DESK  
POUR BUREAU

### lid for cable outlet



### plastic flap



### metal flap



## elementi appesi

HANGING ELEMENTS  
ÉLÉMENTS SUSPENDU



Cassetto metallico appeso  
Hanging metal drawer  
Tiroir suspendu en métal



Portacasco/portaborsa e cassetta in metallo  
Helmet and bag holders and metal drawer  
Porte casque/sac et tiroir en métal



Porta cpu metallico appeso  
Hanging metal pc holder  
Supporte uc métallique suspendu



Vasca cablaggio per scrivania  
Cable tray for desk  
Goulotte pour bureau



Raccogliacavi  
Cable tray  
Passe-cable



Carter salita cavi  
Vertical cable duct  
Passage câbles



Porta cpu metallico su ruote  
Metal pc holder on castors  
Support pc en métal sur roulettes



Cassettiera in metallo  
Metal pedestal  
Caisson en métal



Cassettiera in melaminico  
Melamine pedestal  
Caisson en mélamine

**per tavoli bench**  
FOR BENCH DESKS  
POUR BUREAUX DOUBLES

**lid for cable outlet**



**plastic flap**



**metal flap**



**ribs**



**riba**



**cover**



**cablaggio bench**  
BENCH DESK CABLE MANAGEMENT  
CÂBLAGE BUREAU DOUBLE



**CARTER FOR INTERMEDIATE LEG**

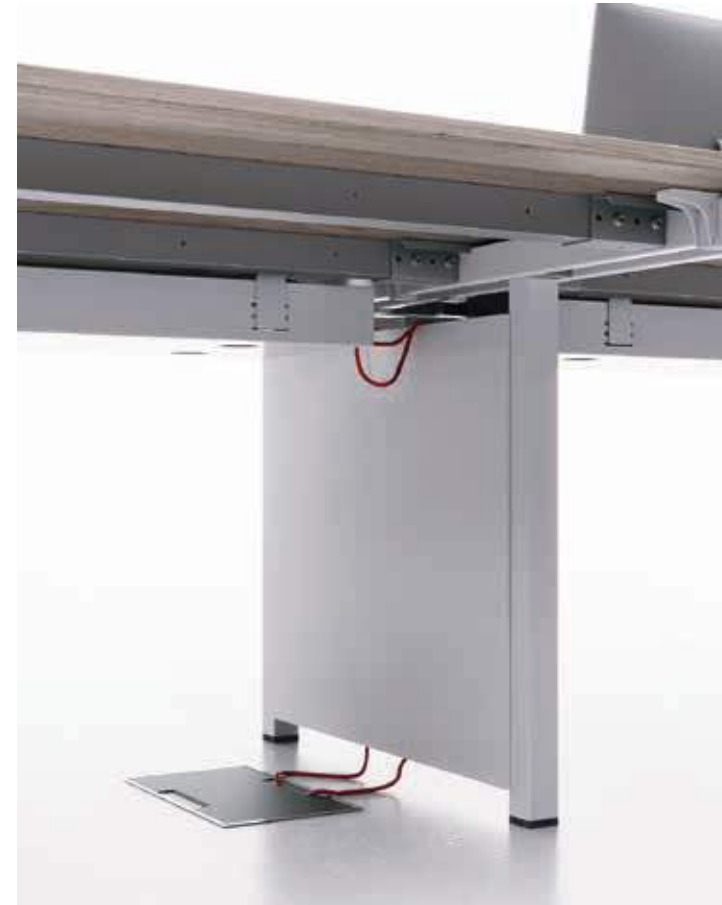

Vasca cablaggio regolabile in altezza con tappi di chiusura  
Height-adjustable cable tray with closing lids  
Goulotte réglable en hauteur avec bouchons de fermeture



Regolazione in altezza (H. 12,5 cm ÷ 15,4 cm)  
Adjustable in height (H. 12,5 cm ÷ 15,4 cm)  
Réglable en hauteur (Ht. 12,5 cm ÷ 15,4 cm)



# DETTAGLI TECNICI

Technical data/Données techniques

## schermi

SCREENS  
PANNEAUX-ÉCRAN



Melaminico  
Melamine  
Mélamine



Tessuto  
Fabric  
Tissu



Vetro  
Glass  
Verre

## Accessori per schermi con barra reggiaccessori

ACCESSORIES FOR SCREENS WITH ACCESSORY BAR  
ACCESSOIRES POUR PANNEAUX ÉCRAN AVEC BARRE PORTE-ACCESSOIRES



Barra reggiaccessori per schermo in melaminico/tessuto  
Accessory bar for melamine/fabric screen  
Barre porte-accessoires pour panneau écran en mélamine/tissu



Supporto porta dox  
Support for file boxes  
Support pour classeur



Supporto porta dox + mensola  
Support for file boxes + shelf  
Support pour classeur + étagère



Vaschetta porta cancelleria  
Stationery tray  
Bac plumier



Vaschetta porta fogli A4  
Size A4 paper tray  
Bac à feuilles format A4



Vaschetta porta oggetti  
Objects tray  
Bac plumier

## DETTAGLI TECNICI

Technical data/Données techniques

### Mobili di servizio portanti

SUPPORTING SERVICE CABINETS  
MEUBLES DE SERVICE PORTANTS



### Accessori per mobili di servizio portanti

ACCESSORIES FOR SUPPORTING SERVICE CABINETS  
ACCESSOIRES POUR MEUBLES DE SERVICE PORTANTS



Ripiano spostabile per mobili di servizio portanti L. 120 cm  
Movable shelf for supporting service cabinets W. 120 cm  
Etagère amovible pour meubles de service portants L. 120 cm



Ripiano spostabile per mobili di servizio portanti L. 165 cm  
Movable shelf for supporting service cabinets W. 165 cm  
Etagère amovible pour meubles de service portants L. 165 cm



Ripiano spostabile per mobili di servizio portanti double L. 165 cm  
Movable shelf for supporting service cabinets double W. 165 cm  
Etagère amovible pour meubles de service portants double L. 165 cm



Cuscino per mobili di servizio portanti L. 120 cm  
Cushion for supporting service cabinets W. 120 cm  
Coussin pour meubles de service portants L. 120 cm



Cuscino per mobili di servizio portanti L. 165 cm  
Cushion for supporting service cabinets W. 165 cm  
Coussin pour meubles de service portants L. 165 cm



Cassettiera 3 cassetti  
Pedestal 3-drawers  
Caisson 3 tiroirs



Cassettiera 1 cassetto + 1 classificatore  
Pedestal 1 drawer + 1 filing unit  
Caisson avec 1 tiroir et 1 tiroir ds



Cassettiera 2 cassetti  
Pedestal 2-drawers  
Caisson 2 tiroirs



## DETTAGLI TECNICI

Technical data/Données techniques

### sistemi di cablaggio

WIRE MANAGEMENT SYSTEM  
SYSTÈME DE GESTION DE CÂBLES



FINITURE  
Finishes / Finitions

FINITURE  
FINISHES/FINITIONS

pop woody

pop easy / square / ace

struttura

STRUCTURE  
STRUCTURE

metal



BI WHITE  
RAL 9010

solid wood



TRANSPARENT  
VARNISHED  
NATURAL ASH

metal



NE BLACK  
RAL 9005

solid wood

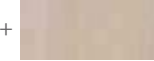

TRANSPARENT  
VARNISHED  
NATURAL ASH

piano

TOP  
PLATEAU

melamine



MBI WHITE



MTR DOVE



MCE CONCRETE  
TEXTURED EFFECT



MOB LIGHT ELM



MRO OAK



MNT AMERICAN  
WALNUT



MNE BLACK

gonna

MODESTY PANEL  
VOILE DE FOND

melamine



MBI WHITE



MTR DOVE



MCE CONCRETE  
TEXTURED EFFECT



MOB LIGHT ELM



MRO OAK



MNT AMERICAN  
WALNUT



MNE BLACK

vasca di cablaggio

CABLE TRAY  
GOULOTTE

metal



BI WHITE  
RAL 9010



NE BLACK  
RAL 9005

schermi

SCREENS  
PANNEAUX-ÉCRAN

melamine



MBI WHITE



MTR DOVE



MCE CONCRETE  
TEXTURED EFFECT



MOB LIGHT ELM



MRO OAK



MNT AMERICAN  
WALNUT



MNE BLACK

glass



VØC FROSTED GLASS

fabric



Cat. D  
King Flex



Cat. F  
Jet

FINITURE

FINISHES/FINITIONS

struttura

STRUCTURE  
STRUCTURE

metal



BI WHITE  
RAL 9010

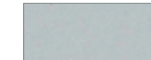

AS ALUMINIUM  
RAL 9006



NE BLACK  
RAL 9005

piano

TOP  
PLATEAU

melamine



MBI WHITE



MTR DOVE



MCE CONCRETE  
TEXTURED EFFECT



MOB LIGHT ELM



MRO OAK



MNT AMERICAN  
WALNUT



MOL ELM  
ONLY FOR  
EASY-SQUARE

gonna

MODESTY PANEL  
VOILE DE FOND

melamine



MBI WHITE



MTR DOVE



MCE CONCRETE  
TEXTURED EFFECT



MOB LIGHT ELM



MRO OAK



MNT AMERICAN  
WALNUT



MNE BLACK



MOL ELM  
ONLY FOR  
EASY-SQUARE

vasca di cablaggio

CABLE TRAY  
GOULOTTE

metal



BI WHITE  
RAL 9010

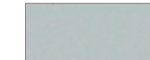

AS SILK ALUMINIUM  
RAL 9006



NE BLACK  
RAL 9005

schermi

SCREENS  
PANNEAUX-ÉCRAN

melamine



MBI WHITE



MTR DOVE



MCE CONCRETE  
TEXTURED EFFECT



MOB LIGHT ELM



MRO OAK



MNT AMERICAN  
WALNUT



MOL ELM  
ONLY FOR  
EASY-SQUARE

glass



VØC FROSTED GLASS

fabric



Cat. D  
King Flex



Cat. F  
Jet

pop easy



pop square



pop ace





**struttura**

STRUCTURE  
STRUCTURE

**metal**



BI WHITE  
RAL 9010



AS SILK ALUMINIUM  
RAL 9006

**piano**

TOP  
PLATEAU

**melamine**



MBI WHITE



MGT ICE GREY



MRO OAK



MNT AMERICAN  
WALNUT

**vasca di cablaggio**

CABLE TRAY  
GOULOTTE

**metal**



BI WHITE  
RAL 9010



AS SILK ALUMINIUM  
RAL 9006

**schermi**

SCREENS  
PANNEAUX-ÉCRAN

**melamine**



MBI WHITE



MGT ICE GREY



MRO OAK



MNT AMERICAN  
WALNUT

**fabric**



Cat. D  
King Flex



Cat. F  
Jet

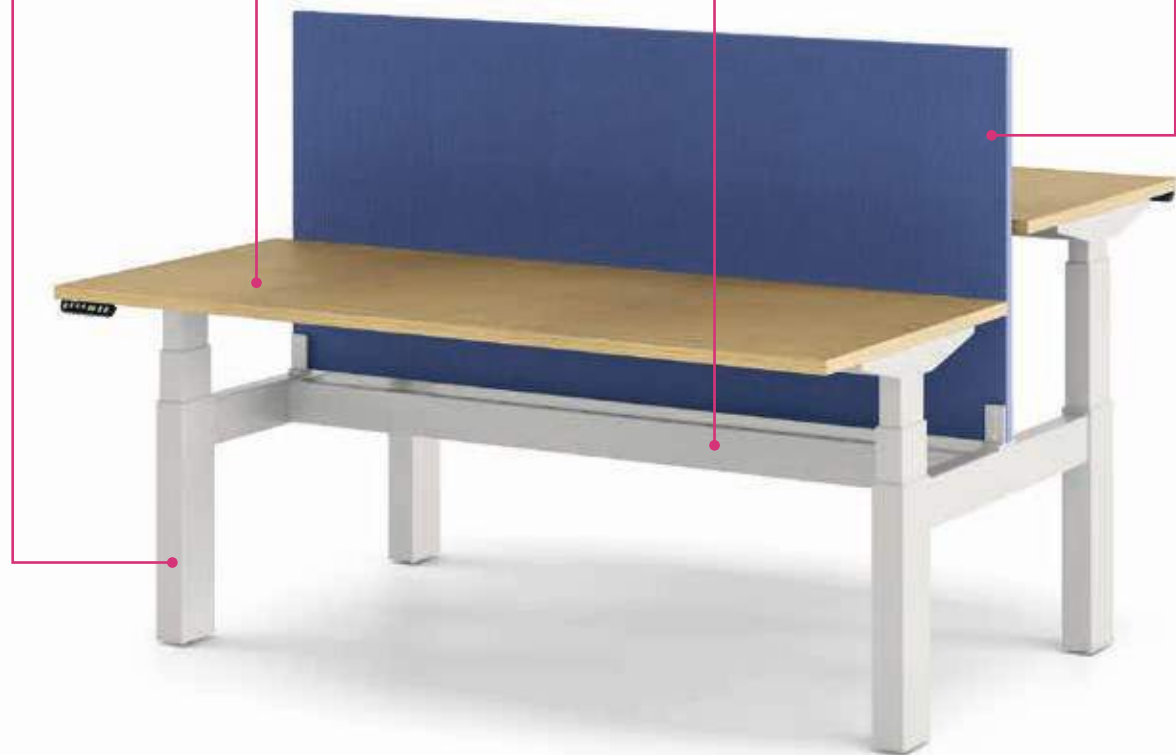

**struttura**

STRUCTURE  
STRUCTURE

**metal**



BI WHITE  
RAL 9010



AS SILK ALUMINIUM  
RAL 9006

**piano**

TOP  
PLATEAU

**melamine**



MBI WHITE



MGT ICE GREY



MRO OAK



MNT AMERICAN  
WALNUT

**gonna**

MODESTY PANEL  
VOILE DE FOND

**melamine**



MBI WHITE



MGT ICE GREY



MRO OAK



MNT AMERICAN  
WALNUT



**piani/gambe**

TOP/LEGS  
PLATEAU/PIETEMENTS

**melamine**



MBI WHITE

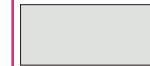

MGT ICE GREY



MRO OAK



MNT AMERICAN  
WALNUT

**gonna**

MODESTY PANEL  
VOILE DE FOND

**melamine**



MBI WHITE

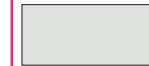

MGT ICE GREY



MRO OAK



MNT AMERICAN  
WALNUT

**vasca cablaggio**

CABLE TRAY  
GOULOTTE

**metal**



BI WHITE  
RAL 9010



AS ALUMINIUM  
RAL 9006



NE BLACK  
RAL 9005

**schermi**

SCREENS  
PANNEAUX-ÉCRAN

**melamine**



MBI WHITE

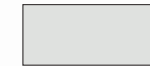

MGT ICE GREY



MRO OAK



MNT AMERICAN  
WALNUT

**glass**



VØC FROSTED  
GLASS

**fabric**



Cat. D  
King Flex



Cat. F  
Jet

**struttura**

STRUCTURE  
STRUCTURE

**metal**



BI WHITE  
RAL 9010



AS ALUMINIUM  
RAL 9006



NE BLACK  
RAL 9005

**piano**

TOP  
PLATEAU

**melamine**



MBI WHITE

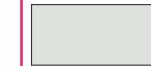

MGT ICE GREY



MRO OAK



MNT AMERICAN  
WALNUT

**gonna**

MODESTY PANEL  
VOILE DE FOND

**melamine**



MBI WHITE

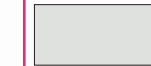

MGT ICE GREY



MRO OAK



MNT AMERICAN  
WALNUT

**vasca cablaggio**

CABLE TRAY  
GOULOTTE

**metal**



BI WHITE  
RAL 9010

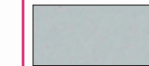

AS ALUMINIUM  
RAL 9006



NE BLACK  
RAL 9005

**schermi**

SCREENS  
PANNEAUX-ÉCRAN

**melamine**



MBI WHITE

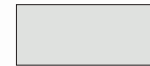

MGT ICE GREY



MRO OAK



MNT AMERICAN  
WALNUT

**glass**



VØC FROSTED  
GLASS

**fabric**



Cat. D  
King Flex



Cat. F  
Jet

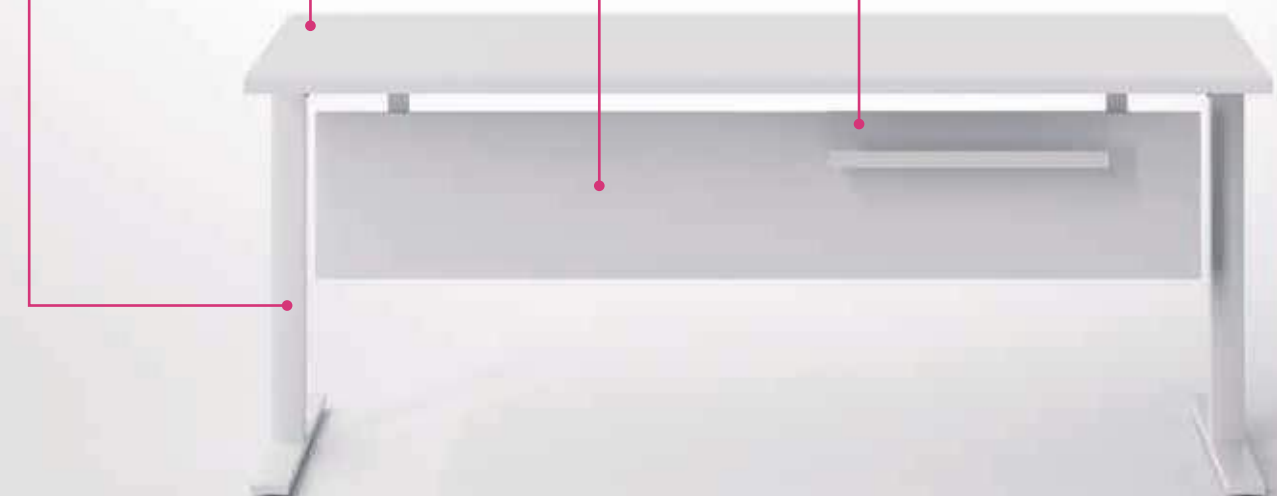



# FINITURE

FINISHES/FINITIONS

## struttura

STRUCTURE  
STRUCTURE

### metal



BI WHITE  
RAL 9010



AS ALUMINIUM  
RAL 9006



NE BLACK  
RAL 9005



CR POLISHED  
CHROME

## piano

TOP  
PLATEAU

### melamine th.18 mm



MBI WHITE



MTR DOVE



MNE BLACK



MCE CONCRETE  
TEXTURED EFFECT



MOB LIGHT ELM



MRO OAK



MNT AMERICAN WALNUT



MRC TOBACCO OAK

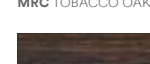

MOL ELM

### melamine th.28 mm



MBI WHITE



MTR DOVE

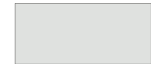

MGT ICE GREY



MOB LIGHT ELM



MRO OAK



MNT AMERICAN WALNUT



MRC TOBACCO OAK

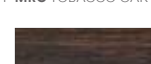

MOL ELM

### melamine th.38 mm



MBI WHITE



MRO OAK



MNT AMERICAN WALNUT



MRC TOBACCO OAK



MOL ELM

### glass th.12 mm



VOC FROSTED

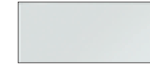

VBI WHITE



VTR DOVE



VNE BLACK



# pop tables

## struttura

STRUCTURE  
STRUCTURE

### metal



BI WHITE  
RAL 9010



NE BLACK  
RAL 9005



CR POLISHED  
CHROME

## piano

TOP  
PLATEAU

### melamine th.18 mm



MBI WHITE



MTR DOVE



MNE BLACK



MCE CONCRETE  
TEXTURED EFFECT



MOB LIGHT ELM



MRO OAK



MNT AMERICAN WALNUT



MRC TOBACCO OAK

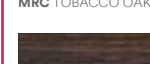

MOL ELM

### melamine th.28 mm



MBI WHITE



MTR DOVE

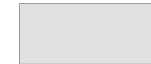

MGT ICE GREY



MOB LIGHT ELM



MRO OAK



MNT AMERICAN WALNUT



MRC TOBACCO OAK



MOL ELM



# FINITURE

FINISHES/FINITIONS

## struttura

STRUCTURE  
STRUCTURE

### metal



BI WHITE  
RAL 9010



CR POLISHED  
CHROME

## piano

TOP  
PLATEAU

### melamine th.18 mm



MBI WHITE



MTR DOVE



MNE BLACK



MCE CONCRETE  
TEXTURED EFFECT



MOB LIGHT ELM



MRO OAK



MNT AMERICAN WALNUT



MRC TOBACCO OAK



MOL ELM



## struttura

STRUCTURE  
STRUCTURE

### melamine



MBI WHITE



MTR DOVE



MCE CONCRETE  
TEXTURED EFFECT



MOB LIGHT ELM



MRO OAK



MNT AMERICAN WALNUT



MOL ELM



## top

TOP  
PLATEAU

### melamine



MBI WHITE



MTR DOVE



MCE CONCRETE  
TEXTURED EFFECT

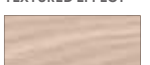

MOB LIGHT ELM



MRO OAK



MNT AMERICAN WALNUT



MOL ELM





# DATI TECNICI POP

## TECHNICAL DATA/DONNÉES TECHNIQUES



easy	square	ace	woody
_0508 L80 P80 H74 _0510 L100 P80 H74 _0512 L120 P80 H74 _0514 L140 P80 H74 _0516 L160 P80 H74 _0518 L180 P80 H74 _0520 L200 P80 H74  _0408 L80 P60 H74 _0410 L100 P60 H74 _0412 L120 P60 H74 _0414 L140 P60 H74 _0416 L160 P60 H74 _0418 L180 P60 H74	_1408 L80 P60 H74 _1410 L100 P60 H74 _1412 L120 P60 H74 _1414 L140 P60 H74 _1416 L160 P60 H74 _1418 L180 P60 H74  EA1428 L80 P42 H74 EA1430 L100 P42 H74 EA1432 L120 P42 H74	_5514 L140 P80 H74 _5516 L160 P80 H74 _5518 L180 P80 H74 _5520 L200 P80 H74	_1554 L140 P80 H74 _1556 L160 P80 H74 _1558 L180 P80 H74 _1560 L200 P80 H74  _3564 L140 P80 H74 _3566 L160 P80 H74 _3568 L180 P80 H74 _3570 L200 P80 H74

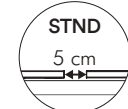

easy	square	ace	woody
_4512 L120 P165 H74 _4514 L140 P165 H74 _4516 L160 P165 H74 _4518 L180 P165 H74 _4520 L200 P165 H74  _4410 L100 P125 H74 _4412 L120 P125 H74 _4414 L140 P125 H74 _4416 L160 P125 H74 _4418 L180 P125 H74	_4532 (120) L240 P165 H74 _4534 (140) L280 P165 H74 _4536 (160) L320 P165 H74 _4538 (180) L360 P165 H74 _4540 (200) L400 P165 H74  _4430 (100) L200 P125 H74 _4432 (120) L240 P125 H74 _4434 (140) L280 P125 H74 _4436 (160) L320 P125 H74 _4438 (180) L360 P125 H74	_6512B L120 P165 H74 _6514B L140 P165 H74 _6516B L160 P165 H74 _6518B L180 P165 H74 _6520B L200 P165 H74  _6310B L100 P125 H74 _6312B L120 P125 H74 _6314B L140 P125 H74 _6316B L160 P125 H74 _6318B L180 P125 H74	EA6512IN L120 P165 H74 EA6514IN L140 P165 H74 EA6516IN L160 P165 H74 EA6518IN L180 P165 H74 EA6520IN L200 P165 H74  EA6310IN L100 P125 H74 EA6312IN L120 P125 H74 EA6314IN L140 P125 H74 EA6316IN L160 P125 H74 EA6318IN L180 P125 H74  _6512F L120 P165 H74 _6514F L140 P165 H74 _6516F L160 P165 H74 _6518F L180 P165 H74 _6520F L200 P165 H74  _6310F L100 P125 H74 _6312F L120 P125 H74 _6314F L140 P125 H74 _6316F L160 P125 H74 _6318F L180 P125 H74



ace	woody
_0538 L180 P90 H74 _0540 L200 P90 H74	_1430 L100 P60 H74
_5538 L180 P90 H74 _5540 L200 P90 H74	PA1578 L180 P90 H74 PA1580 L200 P90 H74
PA3588 L180 P90 H74 PA3590 L200 P90 H74	

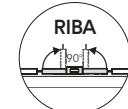

easy	square	ace	woody
_4712 L120 P165 H74 _4714 L140 P165 H74 _4716 L160 P165 H74 _4718 L180 P165 H74 _4720 L200 P165 H74	_4732 L240 P165 H74 _4734 L280 P165 H74 _4736 L320 P165 H74 _4738 L360 P165 H74 _4740 L400 P165 H74	_8512B L120 P165 H74 _8514B L140 P165 H74 _8516B L160 P165 H74 _8518B L180 P165 H74 _8520B L200 P165 H74	EA8512IN L120 P165 H74 EA8514IN L140 P165 H74 EA8516IN L160 P165 H74 EA8518IN L180 P165 H74 EA8520IN L200 P165 H74  _8512F L120 P165 H74 _8514F L140 P165 H74 _8516F L160 P165 H74 _8518F L180 P165 H74 _8520F L200 P165 H74

### accessori

Accessories  
Accessoires

<b>Modesty panel</b> PE0310 L80 P1,8 H30 PE0312 L100 P1,8 H30 PE0314 L120 P1,8 H30 PE0316 L140 P1,8 H30 PE0318 L160 P1,8 H30 PE0320 L180 P1,8 H30	<b>Closing panel for pop easy leg</b> EA9206 (60) x1 EA9208 (80) x1	<b>Closing panel for pop square leg</b> PQ9206 (60) x1 PQ9208 (80) x1 PQ9213 (125) x1 PQ9217 (165) x1	<b>Desk pad</b> TG9508 L80 P50 H0,3

easy	ace	woody
_1717 L165 P165 H74 _1613 L125 P125 H74  _1614 L140 P125 H74 _1616 L160 P125 H74 _1618 L180 P125 H74 _1620 L200 P125 H74 _1622 L220 P125 H74	_1624 L240 P125 H74	_1733 (165) L330 P165 H74  _1628 (140) L280 P125 H74 _1632 (160) L320 P125 H74 _1636 (180) L360 P125 H74 _1644 (220) L440 P125 H74
EA2712N L120 P165 H74 EA2714N L140 P165 H74 EA2716N L160 P165 H74 EA2717N L165 P165 H74 EA2718N L180 P165 H74  EA2612N L120 P125 H74 EA2614N L140 P125 H74 EA2616N L160 P125 H74 EA2618N L180 P125 H74		

# DATI TECNICI POP

## TECHNICAL DATA/DONNÉES TECHNIQUES

### schermi per scrivania/bench

Screens for desk/bench desk  
Panneaux écran pour bureau/bureau double

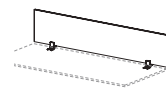

melamine

PPS110M	L100	P1,8	H38,5
PPS112M	L120	P1,8	H38,5
PPS114M	L140	P1,8	H38,5
PPS116M	L160	P1,8	H38,5
PPS118M	L180	P1,8	H38,5
PPS120M	L200	P1,8	H38,5

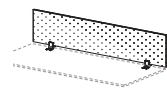

fabric upholstered

PPS110T	L100	P2	H38,5
PPS112T	L120	P2	H38,5
PPS114T	L140	P2	H38,5
PPS116T	L160	P2	H38,5
PPS118T	L180	P2	H38,5
PPS120T	L200	P2	H38,5

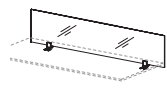

glass

PPS110V	L100	P0,6	H38,5
PPS112V	L120	P0,6	H38,5
PPS114V	L140	P0,6	H38,5
PPS116V	L160	P0,6	H38,5
PPS118V	L180	P0,6	H38,5
PPS120V	L200	P0,6	H38,5



melamine

PPS610M	L100	P1,8	H38,5
PPS612M	L120	P1,8	H38,5
PPS613M	L125	P1,8	H38,5
PPS614M	L140	P1,8	H38,5
PPS616M	L160	P1,8	H38,5
PPS618M	L180	P1,8	H38,5
PPS620M	L200	P1,8	H38,5

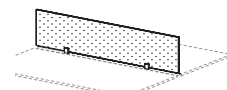

fabric upholstered

PPS610T	L100	P2	H38,5
PPS612T	L120	P2	H38,5
PPS613T	L125	P2	H38,5
PPS614T	L140	P2	H38,5
PPS616T	L160	P2	H38,5
PPS618T	L180	P2	H38,5
PPS620T	L200	P2	H38,5

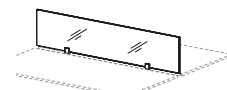

glass

PPS610V	L100	P0,6	H38,5
PPS612V	L120	P0,6	H38,5
PPS613V	L125	P0,6	H38,5
PPS614V	L140	P0,6	H38,5
PPS616V	L160	P0,6	H38,5
PPS618V	L180	P0,6	H38,5
PPS620V	L200	P0,6	H38,5

### guard screen - schermi

Screens  
Panneaux écran



melamine

DSPP110M	L100	P1,8	H60
DSPP112M	L120	P1,8	H60
DSPP114M	L140	P1,8	H60



glass

DSPP110V	L100	P0,6	H60
DSPP112V	L120	P0,6	H60
DSPP114V	L140	P0,6	H60

### schermo laterale

Side screen  
Panneau écran latéral

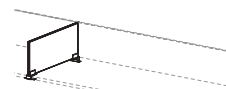

melamine

PPS738M	L80	P1,8	H38,5
---------	-----	------	-------

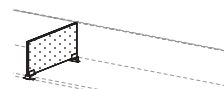

fabric upholstered

PPS738T	L80	P2	H38,5
---------	-----	----	-------



melamine

PPS808M	L80	P1,8	H38,5
PPS817M	L165	P1,8	H38,5
PPS813M	L125	P1,8	H38,5

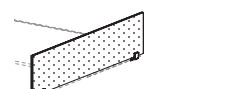

fabric upholstered

PPS808T	L80	P2	H38,5
PPS817T	L165	P2	H38,5
PPS813T	L125	P2	H38,5

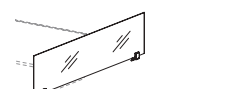

glass

PPS808V	L80	P0,6	H38,5
PPS817V	L165	P0,6	H38,5
PPS813V	L125	P0,6	H38,5

### elettificazione

Wiring elements  
Electrification

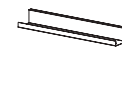

Cable tray for desk

PP9205	L50	P11	H8
PP9207	L70	P11	H8



Cable tray for bench desk

PE9270	(100)	L80	P15	H9
PE9272	(120)	L100	P15	H9
PE9274	(140)	L120	P15	H9
PE9276	(160)	L140	P15	H9
PE9278	(180)	L160	P15	H9
PE9280	(200)	L180	P15	H9

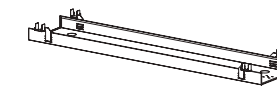

Cable tray for bench desk

PE9218	(80)	L60	P34	H12 ÷ 15
PE9220	(100)	L80	P34	H12 ÷ 15
PE9222	(120)	L100	P34	H12 ÷ 15
PE9224	(140)	L120	P34	H12 ÷ 15
PE9226	(160)	L140	P34	H12 ÷ 15
PE9228	(180)	L160	P34	H12 ÷ 15
PE9230	(200)	L180	P34	H12 ÷ 15

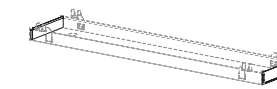

2 caps for bench desk cable tray

PP9209	L34	P1	H7
--------	-----	----	----

### barra reggiaccessori per schermo in melaminico/tessuto

Accessory bar for melamine/fabric upholstered screen  
Barre porte-accessoires pour panneau écran en mélamine/tissu

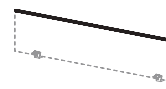

PPF110	L100	P1,9	H38,5
PPF112	L120	P1,9	H38,5
PPF113	L125	P1,9	H38,5
PPF114	L140	P1,9	H38,5
PPF116	L160	P1,9	H38,5
PPF117	L165	P1,9	H38,5
PPF118	L180	P1,9	H38,5
PPF120	L200	P1,9	H38,5

### accessori per schermi con barra reggiaccessori

Accessories for screens with accessory bar  
Accessoires pour panneaux écran avec barre porte-accessoires

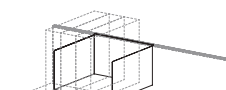

CR9555	L33	P23	H20
--------	-----	-----	-----

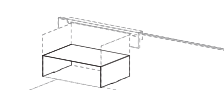

only for CR9555

CR9560	L33	P23	H10
--------	-----	-----	-----

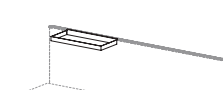

CR9558	L30	P10	H2,5
--------	-----	-----	------

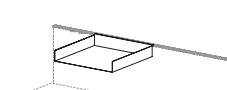

CR9559	L33	P23	H5
--------	-----	-----	----

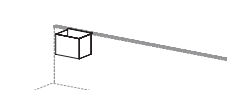

CR9556	L13	P10	H10
--------	-----	-----	-----



Cover

PE9510	L100	P3	H2
PE9512	L120	P3	H2
PE9514	L140	P3	H2
PE9516	L160	P3	H2
PE9518	L180	P3	H2
PE9520	L200	P3	H2

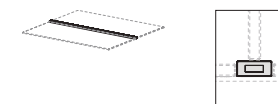

Central metal profile

PE9248	L80	P5	H2
PE9250	L100	P5	H2
PE9252	L120	P5	H2
PE9253	L125	P5	H2
PE9254	L140	P5	H2
PE9256	L160	P5	H2
PE9257	L165	P5	H2
PE9258	L180	P5	H2
PE9260	L200	P5	H2

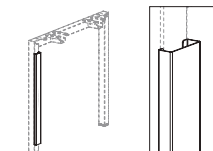

Carter for leg

PT9201	L5	P3	H56
--------	----	----	-----

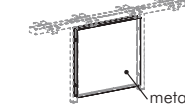

Carter for intermediate leg

PE9208	(80)	L17	P5	H59
PE9213	(125)	L22	P5	H59
PE9217	(165)	L66	P5	H59



Cable duct

PO9230	H84
PO9232	H140



CPU Holder

PCPU01	L22	P50	H56
--------	-----	-----	-----



CPU Holder

PCPU21	L26	P49	H59
--------	-----	-----	-----



# DATI TECNICI POP

## TECHNICAL DATA/DONNÉES TECHNIQUES

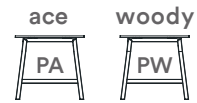

### tavoli H. 105 cm

tables H. 105 cm  
tables Ht. 105 cm

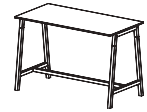

\_\_0562 L120 P80 H105  
\_\_0564 L140 P80 H105  
\_\_0566 L160 P80 H105  
\_\_0568 L180 P80 H105

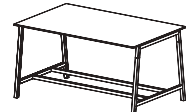

\_\_1654 L140 P125 H105  
\_\_1656 L160 P125 H105  
\_\_1658 L180 P125 H105  
\_\_1660 L200 P125 H105

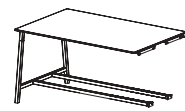

\_\_1674 L140 P125 H105  
\_\_1676 L160 P125 H105  
\_\_1678 L180 P125 H105  
\_\_1680 L200 P125 H105

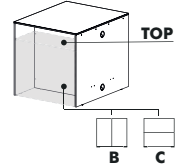

CS0960 L104 P125 H105

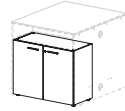

B  
AF13102 L100 P46 H80

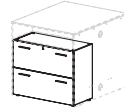

C  
AF13143M L100 P46 H80

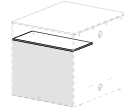

TOP  
AFTB121F L100 P46 H1,8

### accessori per tavolo H. 105 cm

Accessories for tables H. 105 cm  
Accessoires pour tables Ht. 105 cm



Cable duct  
PO9232 H140

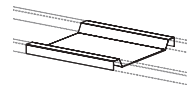

Bag holder  
PA9201 L50 P50 H5



Bag hook  
PA9501 L5 P7 H6

### tavoli circolari

Round tables  
Tables circulaires



PA1750 Ø100 H74  
PA1752 Ø120 H74  
PA1754 Ø140 H74  
PA1756 Ø160 H74  
PA1758 Ø180 H74



PW1750 Ø100 H74  
PW1752 Ø120 H74  
PW1754 Ø140 H74  
PW1756 Ø160 H74  
PW1758 Ø180 H74

### pop tables

Tables  
Tables



VR908 Ø 80 H74  
VR910 Ø 100H74  
VR912 Ø 120H74



VR928 Ø 80 H74  
VR930 Ø 100H74  
VR932 Ø 120H74

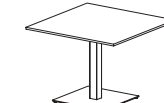

VR938 L80 P80 H74  
VR940 L100 P100 H74

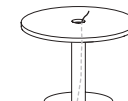

VR918 Ø 80 H74  
VR920 Ø 100H74  
VR922 Ø 120H74



VR908V Ø 80 H74  
VR910V Ø 100H74  
VR912V Ø 120H74



VR928V Ø 80 H74  
VR930V Ø 100H74  
VR932V Ø 120H74



CS1726 Ø 60 H75 ÷ 113



CS1736 L60 P60 H75 ÷ 113



CS1746 Ø 60 H88 ÷ 125



CS1756 L60 P60 H88 ÷ 125

### baguette - bancone reception

Counter for desk  
Comptoir d'accueil

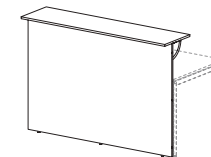

TBF12 L120 P40 H110  
TBF14 L140 P40 H110  
TBF16 L160 P40 H110  
TBF18 L180 P40 H110  
TBF20 L200 P40 H110



TBFA80 L93 P93 H110

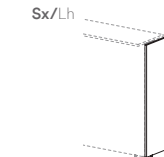

Sx/Lh TBF7 L62 P1,8 H107  
Dx/Rh TBF6 L62 P1,8 H107  
Sx/Lh TBF9 L82 P1,8 H107  
Dx/Rh TBF8 L82 P1,8 H107

# DATI TECNICI POP

## TECHNICAL DATA/DONNÉES TECHNIQUES

ad

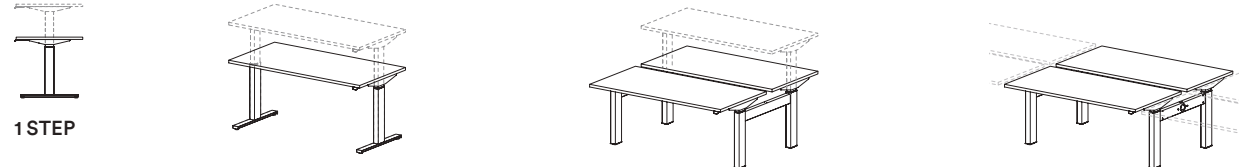

1 STEP

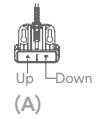

PO05121A	L120	P80	H73 ÷ 113
PO05141A	L140	P80	H73 ÷ 113
PO05161A	L160	P80	H73 ÷ 113
PO05181A	L180	P80	H73 ÷ 113
PO04121A	L120	P60	H73 ÷ 113
PO04141A	L140	P60	H73 ÷ 113
PO04161A	L160	P60	H73 ÷ 113
PO04181A	L180	P60	H73 ÷ 113

### FREESTANDING/STARTING Bench DESK

PO45121A	L120	P170	H73 ÷ 113
PO45141A	L140	P170	H73 ÷ 113
PO45161A	L160	P170	H73 ÷ 113
PO45181A	L180	P170	H73 ÷ 113

### MIDDLE/FINAL Bench DESK

PO65121A	L120	P170	H73 ÷ 113
PO65141A	L140	P170	H73 ÷ 113
PO65161A	L160	P170	H73 ÷ 113
PO65181A	L180	P170	H73 ÷ 113



PO05121B	L120	P80	H73 ÷ 113
PO05141B	L140	P80	H73 ÷ 113
PO05161B	L160	P80	H73 ÷ 113
PO05181B	L180	P80	H73 ÷ 113
PO04121B	L120	P60	H73 ÷ 113
PO04141B	L140	P60	H73 ÷ 113
PO04161B	L160	P60	H73 ÷ 113
PO04181B	L180	P60	H73 ÷ 113

### FREESTANDING/STARTING Bench DESK

PO45121B	L120	P170	H73 ÷ 113
PO45141B	L140	P170	H73 ÷ 113
PO45161B	L160	P170	H73 ÷ 113
PO45181B	L180	P170	H73 ÷ 113

### MIDDLE/FINAL Bench DESK

PO65121B	L120	P170	H73 ÷ 113
PO65141B	L140	P170	H73 ÷ 113
PO65161B	L160	P170	H73 ÷ 113
PO65181B	L180	P170	H73 ÷ 113

ad

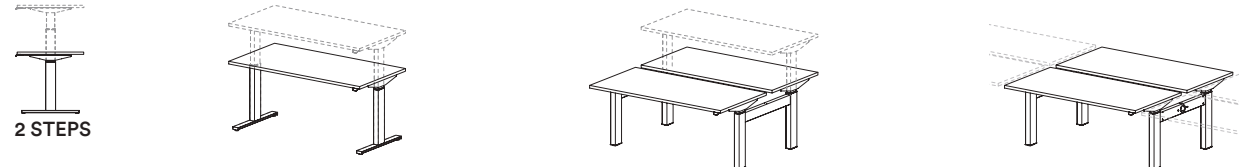

2 STEPS

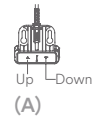

PO05122A	L120	P80	H65 ÷ 125
PO05142A	L140	P80	H65 ÷ 125
PO05162A	L160	P80	H65 ÷ 125
PO05182A	L180	P80	H65 ÷ 125
PO04122A	L120	P60	H65 ÷ 125
PO04142A	L140	P60	H65 ÷ 125
PO04162A	L160	P60	H65 ÷ 125
PO04182A	L180	P60	H65 ÷ 125

### FREESTANDING/STARTING Bench DESK

PO45122A	L120	P170	H65 ÷ 125
PO45142A	L140	P170	H65 ÷ 125
PO45162A	L160	P170	H65 ÷ 125
PO45182A	L180	P170	H65 ÷ 125

### MIDDLE/FINAL Bench DESK

PO65122A	L120	P170	H65 ÷ 125
PO65142A	L140	P170	H65 ÷ 125
PO65162A	L160	P170	H65 ÷ 125
PO65182A	L180	P170	H65 ÷ 125



PO05122B	L120	P80	H65 ÷ 125
PO05142B	L140	P80	H65 ÷ 125
PO05162B	L160	P80	H65 ÷ 125
PO05182B	L180	P80	H65 ÷ 125
PO04122B	L120	P60	H65 ÷ 125
PO04142B	L140	P60	H65 ÷ 125
PO04162B	L160	P60	H65 ÷ 125
PO04182B	L180	P60	H65 ÷ 125

### FREESTANDING/STARTING Bench DESK

PO45122B	L120	P170	H65 ÷ 125
PO45142B	L140	P170	H65 ÷ 125
PO45162B	L160	P170	H65 ÷ 125
PO45182B	L180	P170	H65 ÷ 125

### MIDDLE/FINAL Bench DESK

PO65122B	L120	P170	H65 ÷ 125
PO65142B	L140	P170	H65 ÷ 125
PO65162B	L160	P170	H65 ÷ 125
PO65182B	L180	P170	H65 ÷ 125

## schermi per scrivania

Screens for desk  
Panneaux écran pour bureau

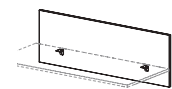

melamine

POS112	L116	P2,8	H60
POS114	L136	P2,8	H60
POS116	L156	P2,8	H60
POS118	L176	P2,8	H60

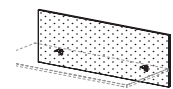

fabric upholstered

POS112	L116	P3	H60
POS114	L136	P3	H60
POS116	L156	P3	H60
POS118	L176	P3	H60

## schermi per bench

Screens for bench desk  
Panneaux écran pour bureau double

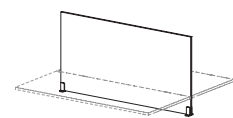

melamine

POS612	L116	P2,8	H80
POS614	L136	P2,8	H80
POS616	L156	P2,8	H80
POS618	L176	P2,8	H80

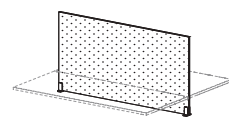

fabric upholstered

POS612	L116	P3	H80
POS614	L136	P3	H80
POS616	L156	P3	H80
POS618	L176	P3	H80

## schermo laterale per bench

Side screen for bench desk  
Panneaux écran latéral pour bureau double

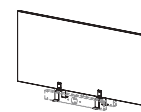

melamine

POS717	L167	P2,8	H80
--------	------	------	-----

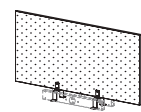

fabric upholstered

POS717	L167	P3	H80
--------	------	----	-----

## elettrificazione

Wiring elements  
Electrification



### Cable tray for desk

PP9205	L50	P11	H8
PP9207	L70	P11	H8

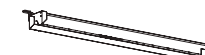

### Cable tray for desk

PT9212	(120)	L100	P15	H9
PT9214	(140)	L120	P15	H9
PT9216	(160)	L140	P15	H9
PT9218	(180)	L160	P15	H9



### Cable tray for bench desk

PO9211	(120)	L106	P20	H9
PO9213	(140)	L126	P20	H9
PO9215	(160)	L146	P20	H9
PO9217	(180)	L166	P20	H9

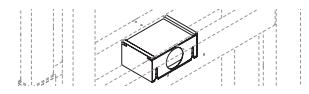

### Connecting bracket for bench desk

PO9202	L20	P14	H9
--------	-----	-----	----

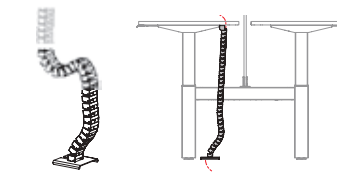

PO9232 H140

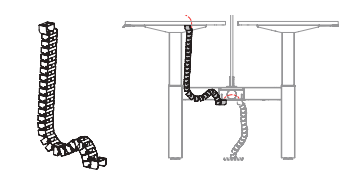

PO9231 H140

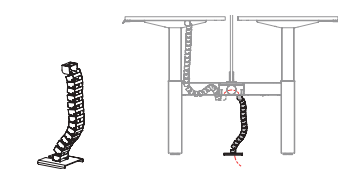

PO9230 H84

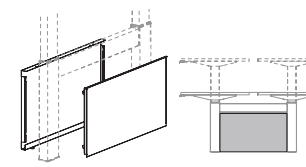

Carter for 1 STEP leg  
PO9241 L79 P5 H49

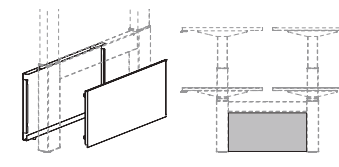

Carter for 2 STEPS leg  
PO9240 L78 P5 H40

## folding

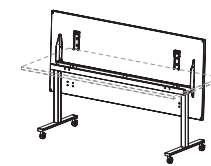

PH0512	L120	P80	H75
PH0514	L140	P80	H75
PH0516	L160	P80	H75
PH0518	L180	P80	H75

PH0412	L120	P60	H75
PH0414	L140	P60	H75
PH0416	L160	P60	H75
PH0418	L180	P60	H75

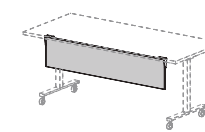

PH0312	(120)	L80	P1,8	H30
PH0314	(140)	L100	P1,8	H30
PH0316	(160)	L120	P1,8	H30
PH0318	(180)	L140	P1,8	H30

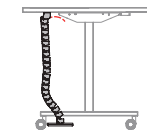

PO9230 H84



# DATI TECNICI POP

## TECHNICAL DATA/DONNÉES TECHNIQUES

### panel

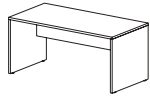

PN0512 L120 P80 H75  
 PN0514 L140 P80 H75  
 PN0516 L160 P80 H75  
 PN0518 L180 P80 H75

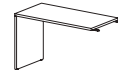

PN1408 L80 P60 H75  
 PN1410 L100 P60 H75  
 PN1412 L120 P60 H75

PN0408 L80 P60 H75  
 PN0410 L100 P60 H75  
 PN0412 L120 P60 H75  
 PN0414 L140 P60 H75  
 PN0416 L160 P60 H75  
 PN0418 L180 P60 H75

### panel

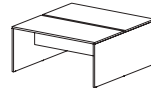

PP4412M L120 P165 H75  
 PP4414M L140 P165 H75  
 PP4416M L160 P165 H75  
 PP4418M L180 P165 H75

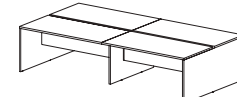

PP4422M (120) L240 P165 H75  
 PP4424M (140) L280 P165 H75  
 PP4426M (160) L320 P165 H75  
 PP4428M (180) L360 P165 H75

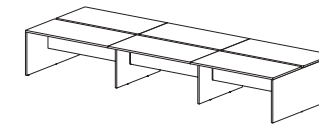

PP4432M (120) L360 P165 H75  
 PP4434M (140) L420 P165 H75  
 PP4436M (160) L480 P165 H75  
 PP4438M (180) L540 P165 H75

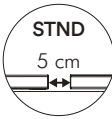

### panel

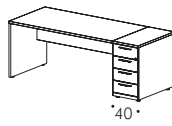

PN0522 L160 P80 H75  
 PN0524 L180 P80 H75  
 PN0526 L200 P80 H75  
 PN0528 L220 P80 H75

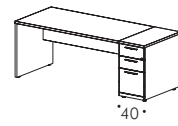

PN0542 L160 P80 H75  
 PN0544 L180 P80 H75  
 PN0546 L200 P80 H75  
 PN0548 L220 P80 H75

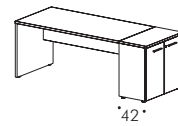

PN0532 L162 P80 H75  
 PN0534 L182 P80 H75  
 PN0536 L202 P80 H75  
 PN0538 L222 P80 H75

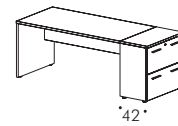

PN0552 L162 P80 H75  
 PN0554 L182 P80 H75  
 PN0556 L202 P80 H75  
 PN0558 L222 P80 H75

### panel

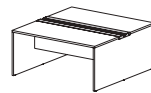

PP4412M L120 P165 H75  
 PP4414M L140 P165 H75  
 PP4416M L160 P165 H75  
 PP4418M L180 P165 H75

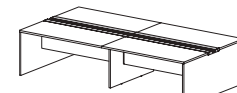

PP4422M (120) L240 P165 H75  
 PP4424M (140) L280 P165 H75  
 PP4426M (160) L320 P165 H75  
 PP4428M (180) L360 P165 H75

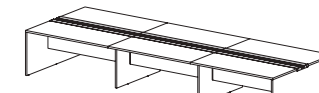

PP4432M (120) L360 P165 H75  
 PP4434M (140) L420 P165 H75  
 PP4436M (160) L480 P165 H75  
 PP4438M (180) L540 P165 H75

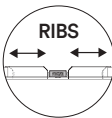

### panel

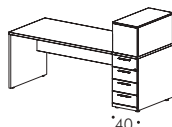

PN0562 L160 P80 H75  
 PN0564 L180 P80 H75  
 PN0566 L200 P80 H75  
 PN0568 L220 P80 H75

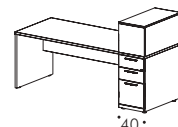

PN0582 L160 P80 H75  
 PN0584 L180 P80 H75  
 PN0586 L200 P80 H75  
 PN0588 L220 P80 H75

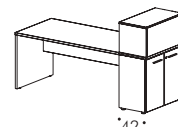

PN0572 L162 P80 H75  
 PN0574 L182 P80 H75  
 PN0576 L202 P80 H75  
 PN0578 L222 P80 H75

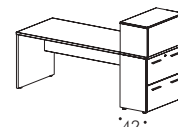

PN0592 L162 P80 H75  
 PN0594 L182 P80 H75  
 PN0596 L202 P80 H75  
 PN0598 L222 P80 H75

### panel



PP4412M L120 P165 H75  
 PP4414M L140 P165 H75  
 PP4416M L160 P165 H75  
 PP4418M L180 P165 H75

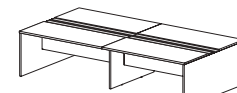

PP4422M (120) L240 P165 H75  
 PP4424M (140) L280 P165 H75  
 PP4426M (160) L320 P165 H75  
 PP4428M (180) L360 P165 H75

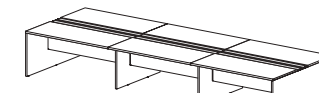

PP4432M (120) L360 P165 H75  
 PP4434M (140) L420 P165 H75  
 PP4436M (160) L480 P165 H75  
 PP4438M (180) L540 P165 H75



### panel

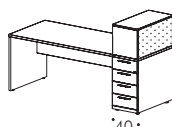

backpanel upholstered in fabric  
 PN0562ST L160 P80 H75  
 PN0564ST L180 P80 H75  
 PN0566ST L200 P80 H75  
 PN0568ST L220 P80 H75

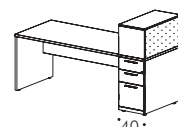

backpanel upholstered in fabric  
 PN0582ST L160 P80 H75  
 PN0584ST L180 P80 H75  
 PN0586ST L200 P80 H75  
 PN0588ST L220 P80 H75

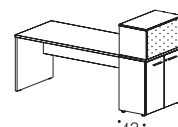

backpanel upholstered in fabric  
 PN0572ST L162 P80 H75  
 PN0574ST L182 P80 H75  
 PN0576ST L202 P80 H75  
 PN0578ST L222 P80 H75

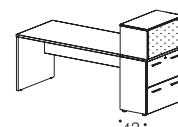

backpanel upholstered in fabric  
 PN0592ST L162 P80 H75  
 PN0594ST L182 P80 H75  
 PN0596ST L202 P80 H75  
 PN0598ST L222 P80 H75

### elettificazione

Wiring elements  
 Electrification



Cable tray for desk  
 PP9205 L50 P11 H8  
 PP9207 L70 P11 H8



Cable tray for desk  
 PT9212 (120) L100 P15 H9  
 PT9214 (140) L120 P15 H9  
 PT9216 (160) L140 P15 H9  
 PT9218 (180) L160 P15 H9



Carter for leg  
 TN9203 L6 P3 H53



CPU Holder  
 PCPU01 L22 P50 H56



Accessories  
 Accessoirs  
 PP9208 L80  
 PP9206 L60

# DATI TECNICI POP

## TECHNICAL DATA/DONNÉES TECHNIQUES

### tee

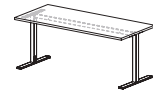

PT0512 L120 P80 H75  
 PT0514 L140 P80 H75  
 PT0516 L160 P80 H75  
 PT0518 L180 P80 H75

PT0408 L80 P60 H75  
 PT0410 L100 P60 H75  
 PT0412 L120 P60 H75  
 PT0414 L140 P60 H75  
 PT0416 L160 P60 H75  
 PT0418 L180 P60 H75

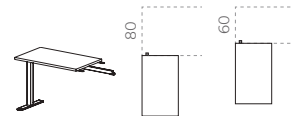

PT1408 L80 P60 H75  
 PT1410 L100 P60 H75  
 PT1412 L120 P60 H75  
 PT1414 L140 P60 H75

PT1428 L80 P60 H75  
 PT1430 L100 P60 H75

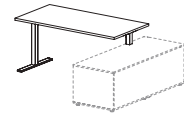

PT1544 L140 P80 H75  
 PT1546 L160 P80 H75  
 PT1548 L180 P80 H75

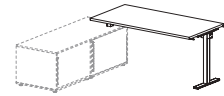

PT1554 L140 P80 H75  
 PT1556 L160 P80 H75  
 PT1558 L180 P80 H75

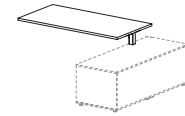

PT2524 L140 P80 H75  
 PT2526 L160 P80 H75  
 PT2528 L180 P80 H75

### tee

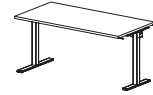

PT1512 L120 P80 H75  
 PT1514 L140 P80 H75  
 PT1516 L160 P80 H75  
 PT1518 L180 P80 H75

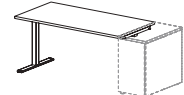

PT1522 L120 P80 H75  
 PT1524 L140 P80 H75  
 PT1526 L160 P80 H75  
 PT1528 L180 P80 H75

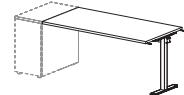

PT1532 L120 P80 H75  
 PT1534 L140 P80 H75  
 PT1536 L160 P80 H75  
 PT1538 L180 P80 H75

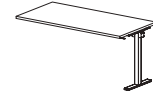

PT2512 L120 P80 H75  
 PT2514 L140 P80 H75  
 PT2516 L160 P80 H75  
 PT2518 L180 P80 H75

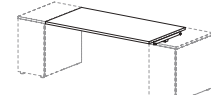

PT3112 L120 P80 H75  
 PT3114 L140 P80 H75  
 PT3116 L160 P80 H75  
 PT3118 L180 P80 H75

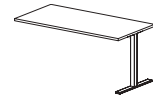

PT3512 L120 P80 H75  
 PT3514 L140 P80 H75  
 PT3516 L160 P80 H75  
 PT3518 L180 P80 H75

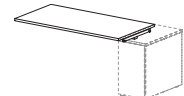

PT4112 L120 P80 H75  
 PT4114 L140 P80 H75  
 PT4116 L160 P80 H75  
 PT4118 L180 P80 H75

### accessori

Accessories  
 Accessoires

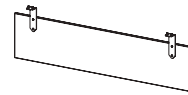

**Modesty panel**  
 PT0310 (100) L80 P1,8 H30  
 PT0312 (120) L100 P1,8 H30  
 PT0314 (140) L120 P1,8 H30  
 PT0316 (160) L140 P1,8 H30  
 PT0318 (180) L160 P1,8 H30

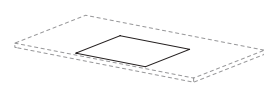

**Desk pad**  
 TG9508 L80 P50 H0,3



**CPU Holder**  
 PCPU01 L22 P50 H56



**CPU Holder**  
 PCPU21 L26 P49 H59

### tee



Dx/Rh PT0716 L160 P120 H75  
 Sx/Lh PT0715 L160 P120 H75



Dx/Rh PT0726 L160 P120 H75  
 Sx/Lh PT0725 L160 P120 H75



Dx/Rh PT0736 L160 P120 H75  
 Sx/Lh PT0735 L160 P120 H75



Dx/Rh PT0746 L160 P120 H75  
 Sx/Lh PT0745 L160 P120 H75

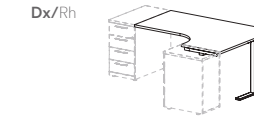

Dx/Rh PT0756 L160 P120 H75  
 Sx/Lh PT0755 L160 P120 H75



Dx/Rh PT1716 L160 P120 H75  
 Sx/Lh PT1715 L160 P120 H75



Dx/Rh PT1726 L160 P120 H75  
 Sx/Lh PT1725 L160 P120 H75

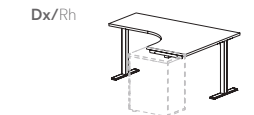

Dx/Rh PT1736 L160 P120 H75  
 Sx/Lh PT1735 L160 P120 H75

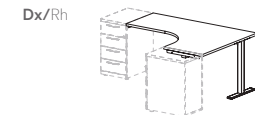

Dx/Rh PT1756 L160 P120 H75  
 Sx/Lh PT1755 L160 P120 H75



PT2712 L120 P120 H75  
 PT2714 L140 P140 H75



PT2722 L120 P120 H75  
 PT2724 L140 P140 H75

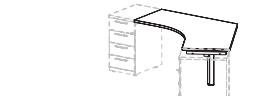

PT2732 L120 P120 H75  
 PT2734 L140 P140 H75

### elettrificazione

Wiring elements  
 Electrification



**Cable tray for desk**  
 PP9205 L50 P11 H8  
 PP9207 L70 P11 H8



**Cable tray for desk**  
 PT9212 (120) L100 P15 H9  
 PT9214 (140) L120 P15 H9  
 PT9216 (160) L140 P15 H9  
 PT9218 (180) L160 P15 H9

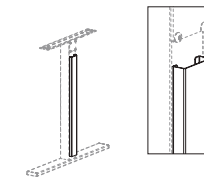

**Carter for leg**  
 PT9201 L5 P3 H56





## DATI TECNICI

TECHNICAL DATA/DONNÉES TECHNIQUES

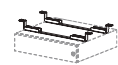

## elementi appesi

Hanging elements  
Eléments suspendu

COMPULSORY for CS0840

PE9505

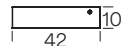

CS0840 L42 P39 H10

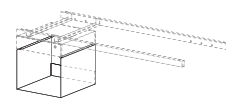

for CS0840

CS0902 L42 P39 H32

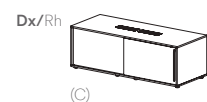
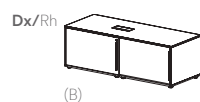
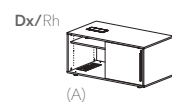

## mobile di servizio

service unit  
meuble de service

Dx/Rh PPM0950 L120 P65 H56 Sx/Lh PPM0951 L120 P65 H56  
 Dx/Rh PPM0952 L165 P65 H56 Sx/Lh PPM0953 L165 P65 H56  
 Dx/Rh PPM0954 L165 P65 H56 Sx/Lh PPM0954 L165 P65 H56

## accessori per mobile di servizio

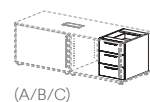
Accessories for service unit  
Accessoires pour meuble de service

CS833 L40 P53 H49

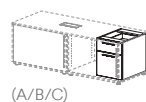

CS834 L40 P53 H49

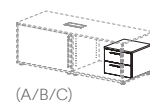

CS835 L42 P41 H35

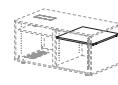

PPR057 L57 P57 H1,8

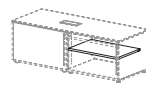

PPR080 L80 P57 H1,8

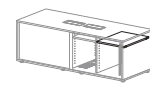

PPR042 L42 P55 H1,8

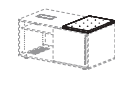

CRC037 L37 P65 H3

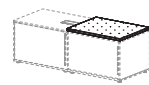
CRC060 L60 P65 H3  
CRC083 L83 P65 H3

## allunghi appesi con cassettera h. scrivania

Hanging extension with desk-height pedestal  
Retour suspendu avec caisson ht bureau

PE1008 L80 P60 H74  
 PE1010 L100 P60 H74  
 PE1012 L120 P60 H74  
 PE1014 L140 P60 H74  
 PE1016 L160 P60 H74  
 PE1018 L180 P60 H74



PE1028 L80 P60 H74  
 PE1030 L100 P60 H74  
 PE1032 L120 P60 H74  
 PE1034 L140 P60 H74  
 PE1036 L160 P60 H74  
 PE1038 L180 P60 H74

## panel



## allunghi appesi con cassettera h. scrivania

Hanging extension with desk-height pedestal  
Retour suspendu avec caisson ht bureau

PN2408 L80 P60 H75  
 PN2410 L100 P60 H75  
 PN2412 L120 P60 H75

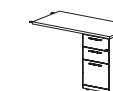

PN3408 L80 P60 H75  
 PN3410 L100 P60 H75  
 PN3412 L120 P60 H75



## cassettiere h. scrivania

Pedestal h. desk  
Caisson ht bureau

CS805 (PVC) L40 P80 H72  
 CS815 (MET) L40 P80 H72



CS807 (PVC) L40 P60 H72  
 CS817 (MET) L40 P60 H72



CS806 (PVC) L40 P80 H72  
 CS816 (MET) L40 P80 H72



CS808 (PVC) L40 P60 H72  
 CS818 (MET) L40 P60 H72



CR2906 L40 P60 H1,8  
 CR2908 L40 P80 H1,8  
 CR2913 L40 P125 H1,8  
 CR2917 L40 P165 H1,8

PPT0806 L40 P60 H2,8  
 PPT0808 L40 P80 H2,8  
 PPT0813 L40 P125 H2,8  
 PPT0817 L40 P165 H2,8

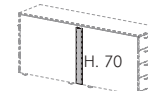

COVER  
 PE9201 L5 P3 H70



CS0938 L80 P40 H42



fabric upholstered backpanel  
 CS0938T L80 P40 H42

## orgatower

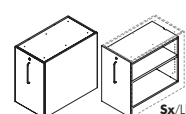

CS0920 Dx/Rh L44 P80 H72  
 CS0920 Sx/Lh L44 P80 H72

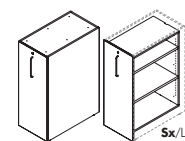

CS0924 Dx/Rh L44 P80 H112  
 CS0924 Sx/Lh L44 P80 H112



CR2928 L44 P80 H1,8  
 CR2937 L44 P165 H1,8

PPT0828 L44 P80 H2,8  
 PPT0837 L44 P165 H2,8

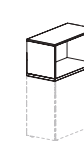

CS0937 L44 P80 H42

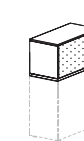

fabric upholstered backpanel  
 CS0937T L44 P80 H42



# DATI TECNICI

TECHNICAL DATA/DONNÉES TECHNIQUES



## armadi ad altezza scrivania

Desk-height cabinets  
Armoires Ht. bureau

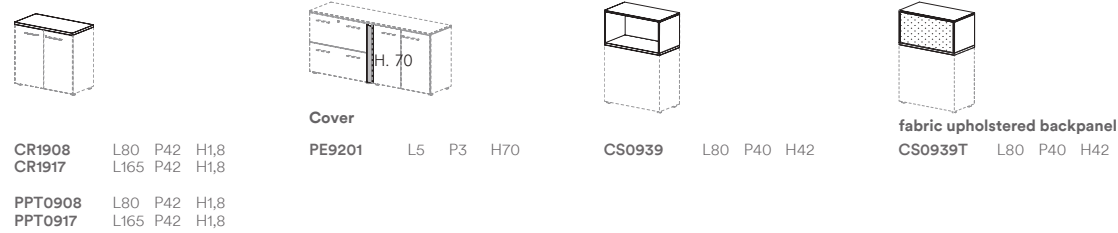
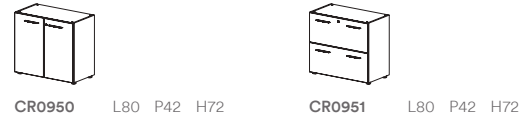

# cabinets

# cabinets SP01 - 1SIDE

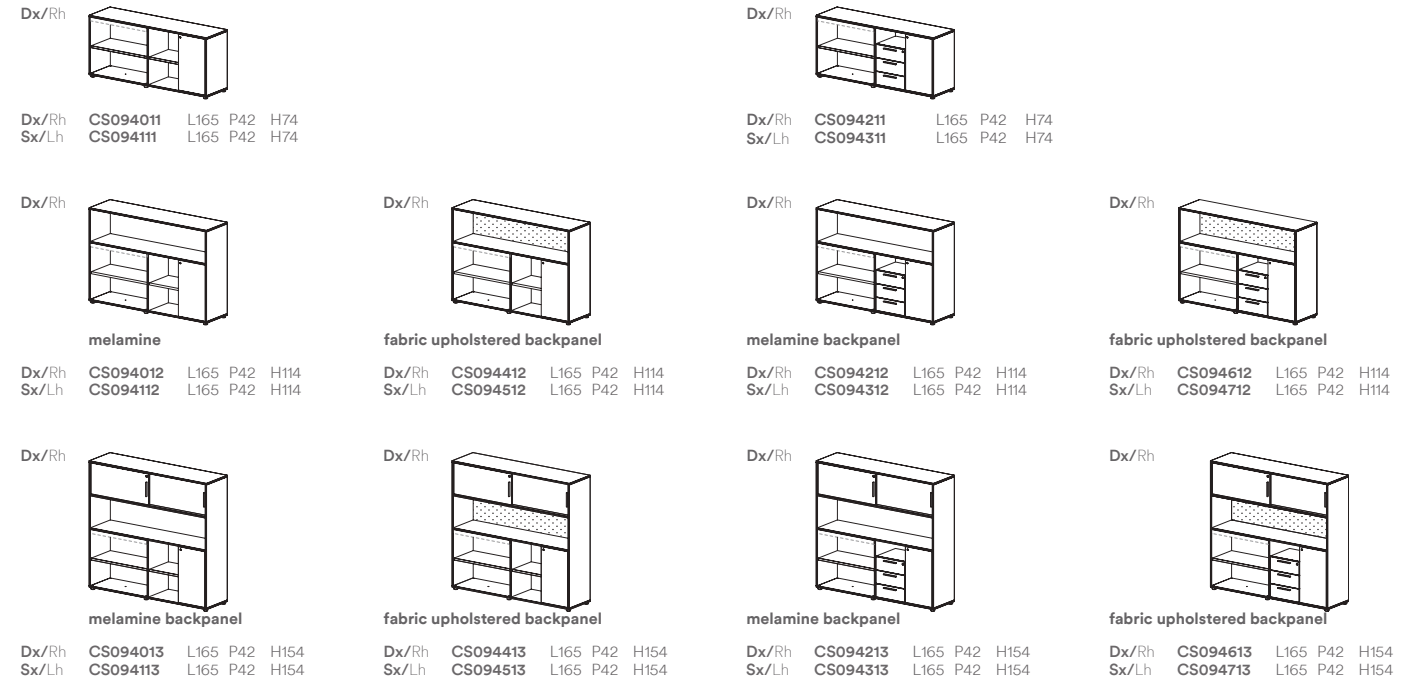
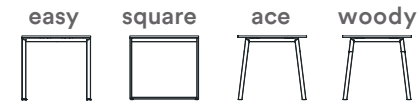

## armadi con ante scorrevoli

Cabinets with sliding doors  
Armoires avec portes coulissantes

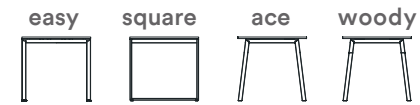
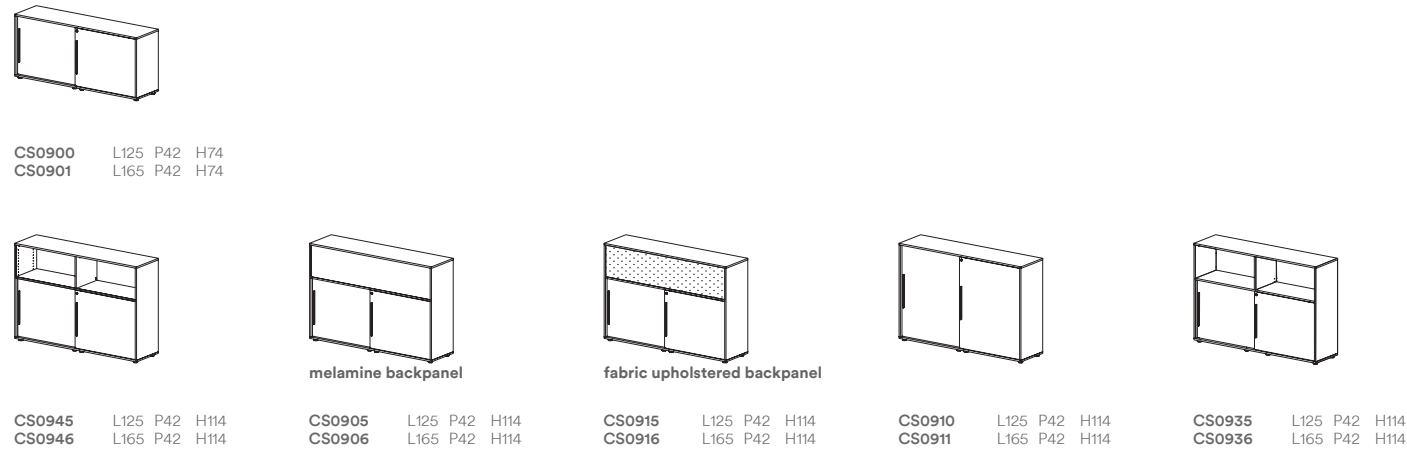

# cabinets SP02 - 2SIDES

