

WHERE MAGIC HAPPENS...



TABLE OF CONTENTS

INTRO	3
<hr/>	
RANGE	7
<hr/>	
• CAMARGUE®	9
• SKYE®	31
• ALGARVE®	37
ALGARVE® 'CLASSIC LINE'	47
• ALGARVE® ROOF	51
• LAPURE®	63
LAPURE® 'CLASSIC LINE'	65
• LAGUNE®	69
• TOSCANE®	83
<hr/>	
OVERVIEW OF RANGE	88
<hr/>	
ACCESSORIES	91
<hr/>	
TECHNICAL INFO	111
<hr/>	
FAQ / TIPS	118
<hr/>	
ABOUT RENSON®	122
<hr/>	





Camargue®

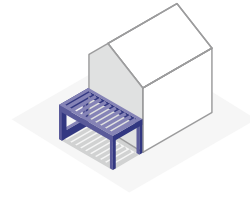

PERFECT OUTDOOR CLIMATE, DAY AND NIGHT, WINTER AND SUMMER WITH **RENSON®**

Regardless of the weather, we like to spend as much time as possible in our garden which is no longer separated from our house but forms an integral part of our living room. Being outside becomes living outdoor.

With many years of experience in sun protection screens and ventilation, RENSON® is lifting the outdoor space to a higher level. Due to the right application of techniques and innovative products, it is now possible to enjoy your terrace and garden in early spring, summer and during the Indian summer period.



music

heating element

lighting

sliding glass wall

sun protection fabric

Loggia wood
sliding panel



The intense enjoyment
of comfortable outdoor living.

THE ULTIMATE COMBINATION OF **QUALITY AND DESIGN**

RENSON® pays a great deal of attention to the quality of the finish, a simple and flexible assembly, as well as the solidity during the development phase of its terrace coverings. The fixation parts have been made **invisible** and the electrical cables have been hidden away inside the structure. Even the ground fixation can be concealed.

You can select a terrace covering to suit your own wishes. Our terrace coverings can be fully made to measure and come in different styles – from traditional to modern or contemporary. So we create for you an elegant and timeless external extension of your home and business.

Lapure®, **Lagune®** and **Toscane®** are always constructed with an angled roof against the wall. **Camargue®**, **Skye®**, **Algarve®** and **Algarve® Roof** have flat, louvered roofs.

There are several installation methods: free-standing with 4 columns, fitted to an outside wall with 1 or 2 columns, or integrated into an existing opening without columns. You can also join different roof components for certain types.

RENSON® also respects sustainability. The materials used are wear-resistant and capable of withstanding both extreme heat and extreme cold. Aluminium, screen fabrics, glass or wood – all of them are strong, maintenance-friendly materials.

LOUVERED ROOFS

ALUMINIUM LOUVERED ROOFS

CAMARGUE®

Innovative, modular terrace covering with horizontal sun protection roof with rotating aluminium blades and completely invisible, integrated side elements.



SKYE®

Modular, innovative and fully closable terrace covering with rotating aluminium blades that **slide open**, with completely invisible, integrated side elements.



ALGARVE®

Terrace covering with horizontal waterproof, sun protection roof with rotating aluminium blades. Surface-mounted side elements are available.



ALGARVE® ROOF

Horizontal waterproof, sun protection roof with rotating aluminium blades that can be integrated into the new architecture or into existing constructions made of stone, wood or other materials.



FABRIC & SCREEN ROOFS

SCREEN ROOFS

LAPURE®

Minimalistic terrace covering with waterproof, windproof and sun protection screen roof, with an open, panoramic view.



LAGUNE®

Terrace covering made of an innovative, waterproof, windproof, transparent fabric in the roof structure with integrated side elements. The perfect cocoon.



VELUM FABRIC ROOFS

TOSCANE®

New type of terrace covering with a folding roof built using patented technology, with invisible, integrated side elements, making it ideal for large areas.







CAMARGUE®

Experience how your life will change once you can spend more time outside. A timeless design and infinite options for personalisation... this terrace covering adapts to suit your home. Enjoy life in style.



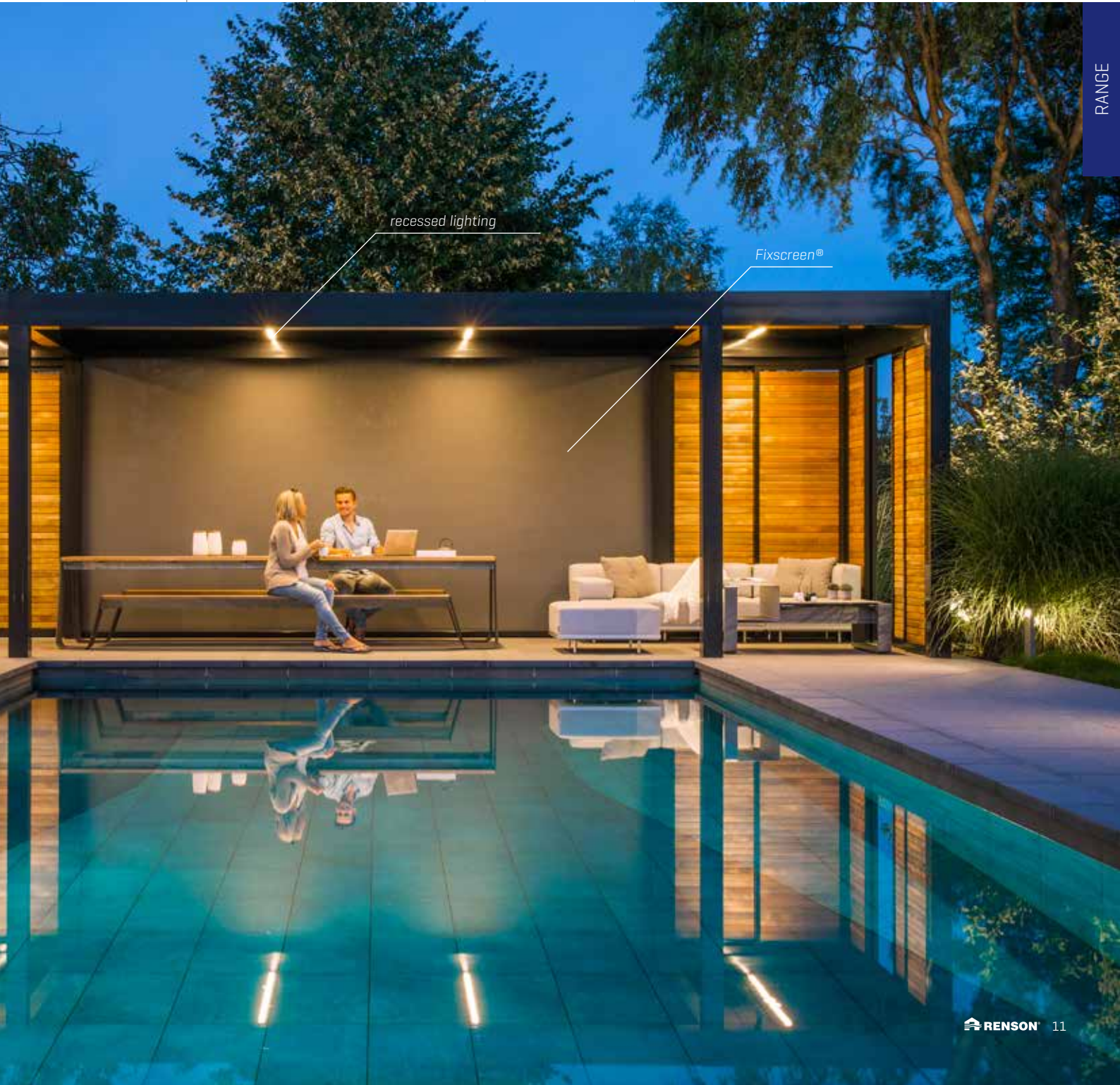

recessed lighting

Fixscreen®

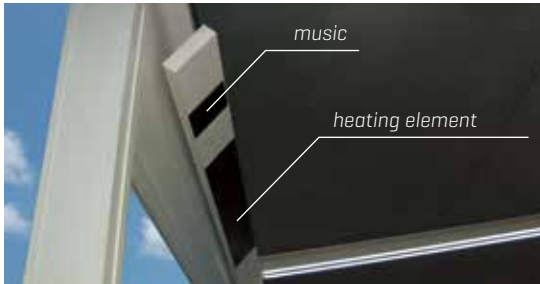

Music/Heating element



LED: white and RGB lighting



Sun protection fabric/Sliding glass wall



Loggiawood Privacy sliding panel



You can completely enclose Camargue® using sliding panels, glass walls or screens, for example...





music

heating element



Multifunctional use

Camargue® can also be used as a “fitness box”, so that you can exercise together with your family and friends in the fresh air, while still being protected from the sun and wind.

Camargue®

Also highly appropriate for meetings and dinner parties.









The perfect integration into your home...
The terrace becomes a part of your living space,
even if the architecture is more classical.





Enjoy it all day long.



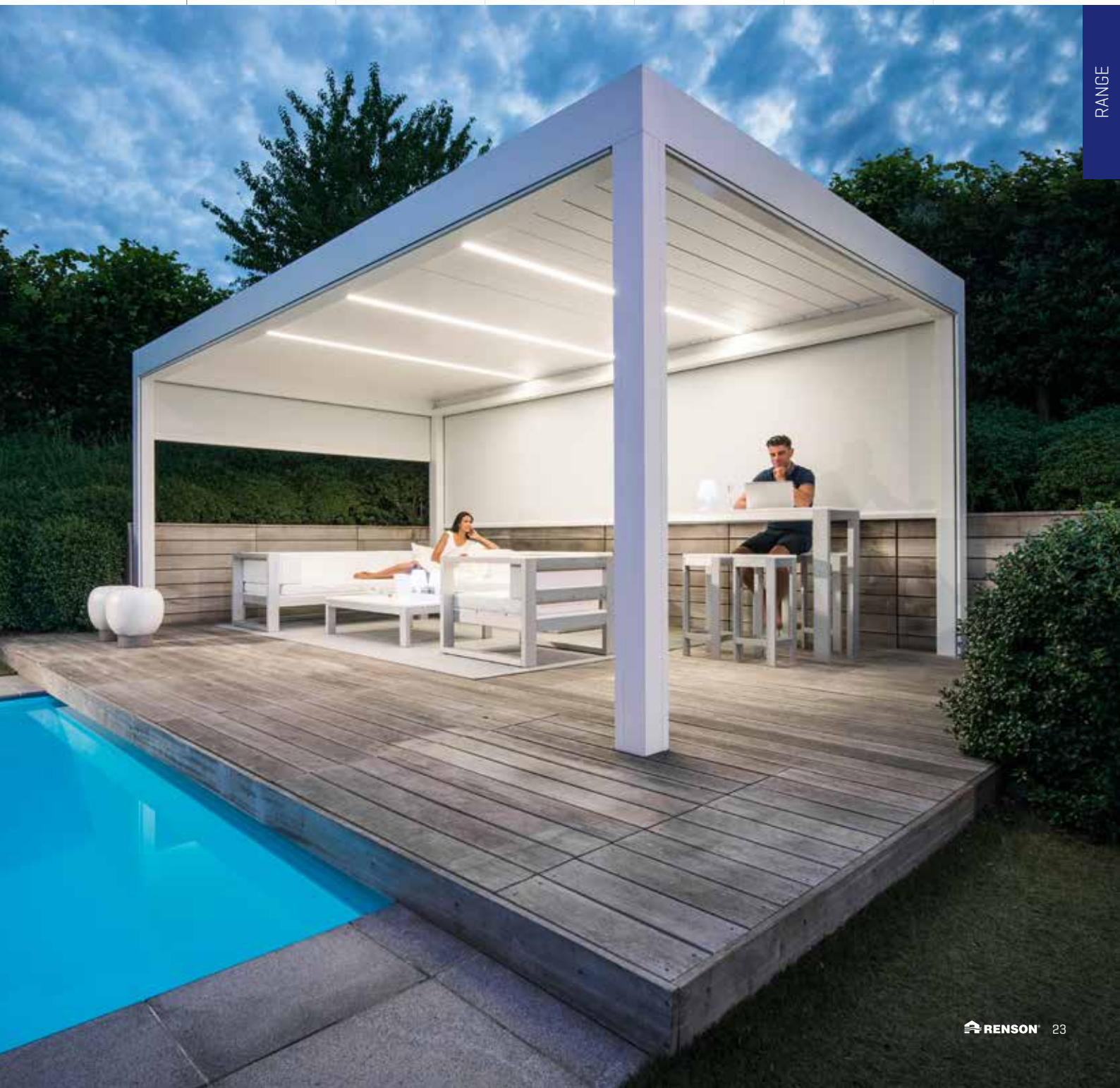

Would you like some sun on your terrace or perhaps not.... With a single press on a button, you instantly get the situation you desire.



Screens



Blades

open*easily adjustable opening**closed*

CAMARGUE®

Innovative and modular terrace covering with horizontal sun protection roof with rotating blades.

Camargue® is an innovative, modular terrace covering with a **louvered roof** that **can be closed off on all sides** using the integrated windproof Fixscreens®, sliding glass walls, Loggia® sliding panels, or a combination of these.

The **roof** is made of extruded aluminium blades that can be rotated to control the **sun protection and ventilation** based on the users' needs. The blades can be easily operated using a Somfy remote control. It is **waterproof** when closed.

The water is carried off to the columns via the **integrated water guide channels**. This water removal also works when the blades are rotated to an open position after it rains, so that the furniture on the patio stays protected.

By adding side elements you create **infinite possibilities for customisation**. **Windproof, motorised Fixscreen® sun protection screens** are available in 50 colours and can be fitted with Crystal Windows. **Sliding glass doors** can be integrated, as well as in combination with integrated Fixscreens®! **Loggia® sliding panels** offer another option. These can be provided with the same fabric as the screens, in Western Red Cedar or aluminium blades.

A great deal of attention is also given to the **quality of the finish**. For example, the fixation parts are **practically invisible**, all of the electrical cables are hidden and invisible floor mounting is also possible.

Camargue's® high-quality materials and design **keep maintenance to a minimum**, while simultaneously guaranteeing **exceptional sustainability**.

The Camargue® fits in with **any architectural style** thanks to its availability in all of the RAL colours and the various customisation options.

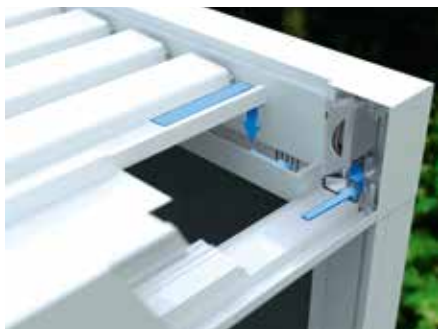

Efficient, integrated water drainage

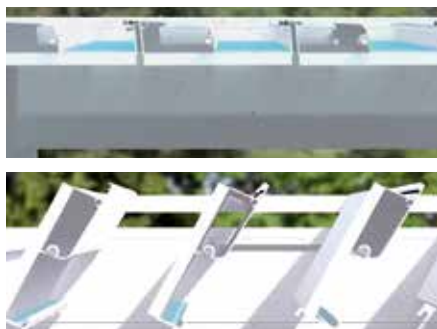

Controlled water drainage when blades are open as well



You can operate your terrace covering easily using Somfy automation.

Dimensions and features

Roof options	Rotating aluminium blades
Dimensions	
Max. width/Pivot	6200
Max. depth/Span	4500
Max. passage height	2800
Joinable	joinable with multiple parts (Span and Pivot)
Min. angle	no angle [0°]
Technical specifications	
Integrated water drainage	standard (incl. PVC drainage pipes in column)
Integrated cables	standard
Integrated motor	standard
Operating switch	not applicable
RTS operation	standard
io-homecontrol® operation	not applicable
Personalisation	
Triangle	not applicable
Glass roof blades - Lineo® Luce	option
Integrated vertical windproof screens	option
Loggiawood sliding door/Loggiascreen 4 ^{FIX} /Loggialu	option
Sliding glass walls	option
Combination of sliding glass walls + integrated windproof screens	option
Loggiawood sliding wall/Loggiascreen 4 ^{FIX} /Loggialu	option
Windproof screens (surface-mounted) with Fixscreen® 100 ^{EVO} Slim F/Fixscreen® 150 ^{EVO} F	not applicable
Integrated LED lighting/in the blade, column or UpDown	option
Beam with Heat & Sound	option

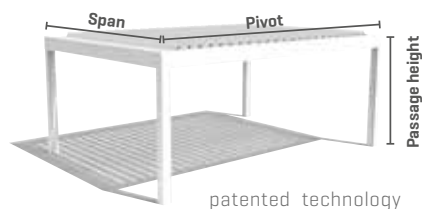

CAMARGUE®

Types of installation

There are two types of installations for the Camargue®: free-standing and façade mounted.



Free-standing



Façade mounted

The frame of the Camargue® is supported by four vertical columns in the **type of installation 1, free-standing** version.

For **type of installation 2, fitted to an outside wall**, one side of the frame is mounted against a supporting, load-bearing construction/structure and partially supported by vertical columns.

The blades can be positioned parallel or perpendicular to the supporting structure.

Joinable

Camargue® can be extended using one of the larger Spans or Pivots to cover larger areas. In this case, a coupling side beam is used.



2-part joinable on the Pivot side



2-part joinable on the Span side



Multiple parts joinable on the Pivot and/or Span side

Integrated Fixscreen®

By integrating the vertical sun protection, the integrated Fixscreen®, with or without Crystal windows to keep a view of the outside, you can create an extra outdoor room where the users are protected from sun, rain and wind.

These screens come in 50 colours and allow you to **personalise** the Camargue® and create the atmosphere you desire.



Camargue® is fitted with the integrated Fixscreen® in the Span and Pivot side

Personalisation possibilities

Camargue® can have various elements fitted to the front and/or sides. By adding side elements you create infinite possibilities for personalisation.



Loggia® sliding panel: Loggiaiwood, Loggiaiwood Privacy, Loggiascreen 4^{FIX}, Loggialu, Loggialu Privacy



Loggia® easy passage: Loggiaiwood, Loggiascreen 4^{FIX}, Loggialu



Sliding glass wall



Sliding glass wall + Integrated Fixscreen®

Mounting bases

There are 3 types of mounting bases: visible, invisible, and cast mounting.

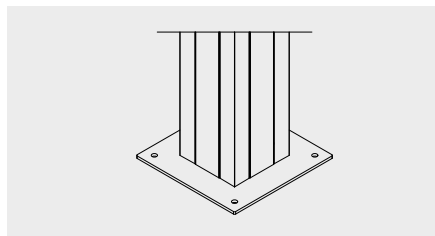

Visible mounting base

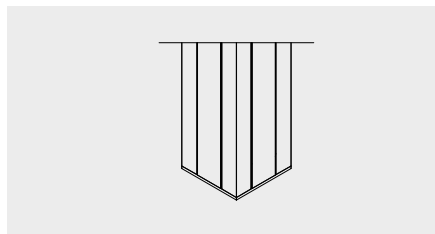

Invisible mounting base

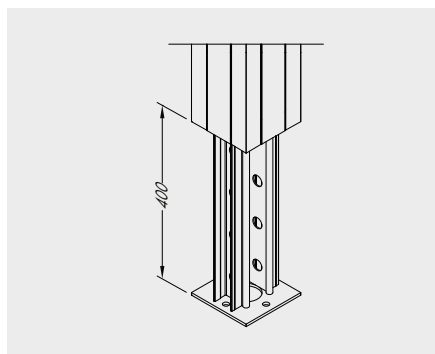

Cast mounting base

Bottom bar disappears into the box

The Camargue's® frame profiles are developed in such a way that the bottom bar is aesthetically hidden away in the box when the screen is raised.

Perfect integration, even afterwards!



The bottom bar disappears into the Camargue's® box.





SKYE® NEW!

Modular, innovative and fully closable terrace covering with rotating aluminium blades that **slide open**.





SKYE® NEW!

Terrace covering with sliding louvered roof.

The newest, most exclusive addition to the RENSON® terrace covering range has aluminium blades in the roof which rotate and slide open. The blades offer protection from the rain, sun and wind. Hot air can escape in the summer and you can slide the roof open in the winter to enjoy the sunlight to the fullest. It is still important, especially when Skye® is mounted to a wall, that sunlight can still shine

into the home. The Skye® terrace covering's blades are designed in such a way that they remove any precipitation laterally.

All fixations, cabling and anchoring is hidden away and the terrace covering can be fitted with LED lights in the blades, columns or profiles, and can also be fitted with heating elements and flat panel speakers.

Skye® can be constructed in several ways: free-standing, fitted to an outside wall, recessed or integrated between two walls. Windproof screens, sliding glass doors or sliding panels can also be integrated.



Dimensions and features

Roof options	Rotating, retractable aluminium blades
Dimensions	
Max. width/Pivot	6200
Max. depth/Span	4500
Max. passage height	2800
Joinable	joinable with multiple parts on the Span side
Min. angle	no angle (0°)
Technical specifications	
Integrated water drainage	standard (incl. PVC drainage pipes in column)
Integrated cables	standard
Integrated motor	standard
Operating switch	not applicable
RTS operation	not applicable
io-homecontrol® operation	not applicable
Personalisation	
Triangle	not applicable
Glass roof blades - Lineo® Luce	not applicable
Integrated vertical windproof screens	option
Loggiawood sliding door/Loggiascreen 4 ^{FIX} /Loggialu	option
Sliding glass walls	option
Combination of sliding glass walls + integrated windproof screens	option
Loggiawood sliding wall/Loggiascreen 4 ^{FIX} /Loggialu	option
Windproof screens (surface-mounted) with Fixscreen® 100 ^{EVO} Slim F/Fixscreen® 150 ^{EVO} F	not applicable
Integrated LED lighting/in the blade or UpDown	option
Beam with Heat & Sound	option

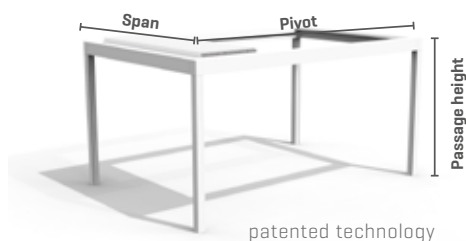





ALGARVE® **ALGARVE® 'CLASSIC LINE'**

A young and modern design... you can place this covering wherever you like – on your terrace, next to your swimming pool or even on its own in your garden.

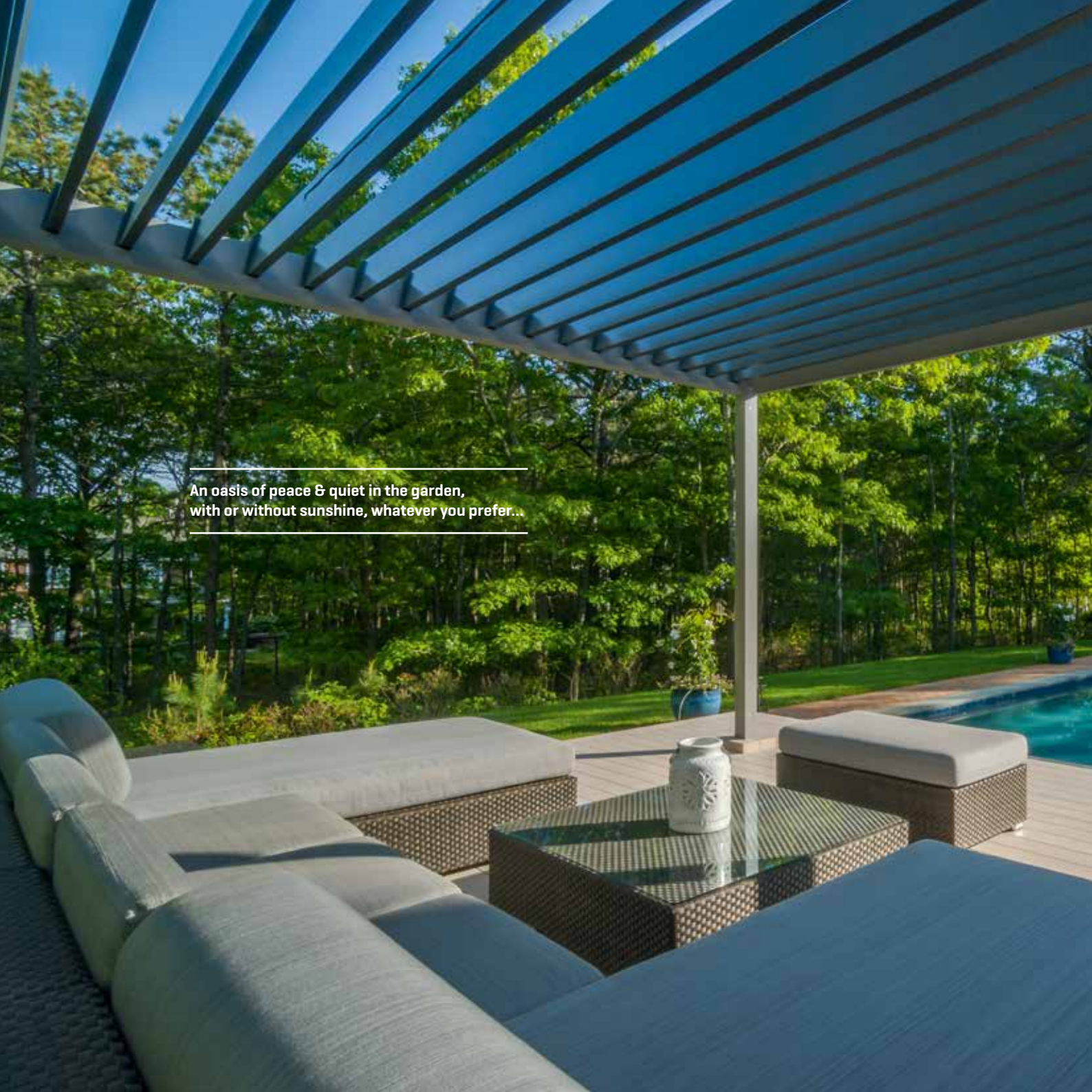

An oasis of peace & quiet in the garden,
with or without sunshine, whatever you prefer...





Also suitable for use in coastal regions.
All RENSON® coverings receive "seaside quality"
[pre]treatment as standard.









An oasis of peace & quiet in the garden,
with or without sunshine, whatever you prefer...





Algarve® “Classic Line”**Sustainable terrace covering with beautifully classic appearance**

Algarve® “Classic Line” is a new line in the range of terrace coverings with adjustable aluminium blades in the roof, so that you can determine for yourself how much light hits the terrace, while being protected from the rain when necessary. The classic finish, using decorative trim and lines in the columns, means that the **Algarve® “Classic Line”** provides a sustainable, maintenance-friendly solution with a beautiful, classic appearance. This terrace covering can be mounted to the wall or used as a stand-alone element, making it the ideal solution for a rustic or classic architectural style.



ALGARVE®

Terrace covering with horizontal sun protection roof with rotating blades.

This simple, practical terrace covering has a sun protection roof with rotating blades. The extruded aluminium blades can be rotated up to 150°, thus providing the possibility to determine for yourself how much sun protection and/or ventilation you desire.

The blades form a waterproof roof when closed. The rainwater is carried to the columns via a drainage gutter. The Algarve® fits in with any architectural style, whether its contemporary, classic or modern, thanks to its elegant, light design and availability in all of the RAL colours.

Joinable!

Algarve® is joinable in two parts (on the Span side) so that exceptional areas of 6 x 6.05 m can be covered without middle columns disrupting the view.

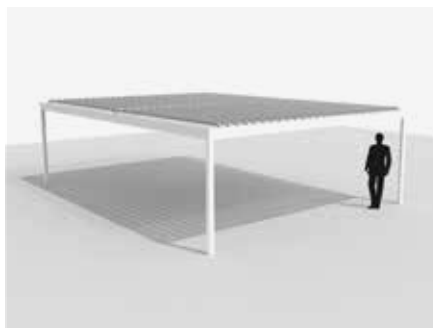

2-part joinable on the Span side



Type of installation 1 - Free-standing

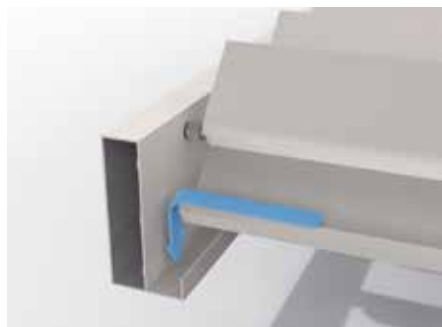

Drainage gutter

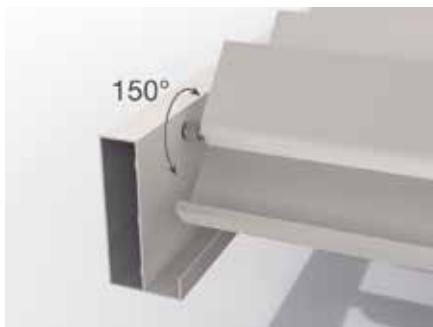

150° rotation



Type of installation 2 - Fitted to an outside wall

Dimensions and features

Roof options	Rotating aluminium blades
Dimensions [mm]	
Max. width/Pivot	6050
Max. depth/Span	4500
Max. passage height	2800
Joinable	joinable in two parts up to 6000 mm on the Span side without an additional column.
Min. angle	no angle [0°]
Technical specifications	
Integrated water drainage	standard
Integrated cables	standard
Integrated motor	not applicable
Operating switch	option
RTS operation	standard
io-homecontrol® operation	not applicable
Personalisation	
Triangle	not applicable
Glass roof blades - Lineo® Luce	option
Integrated vertical windproof screens	not applicable
Loggiawood sliding door/Loggiascreen 4 ^{FIX} /Loggialu	not applicable
Sliding glass walls	not applicable
Combination of sliding glass walls + integrated windproof	not applicable
Loggiawood sliding wall / Loggiascreen 4 ^{FIX} / Loggialu	not applicable
Windproof screens [surface-mounted] with Fixscreen® 100 ^{EVO} Slim F/Fixscreen® 150 ^{EVO} F	option
Integrated LED lighting/in the blade or UpDown	option
Beam with Heat & Sound	option

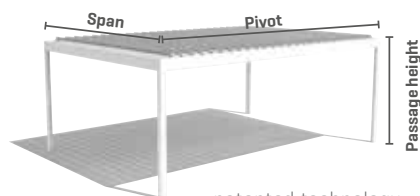

patented technology

Fixscreen® 100^{EVO} Slim F / Fixscreen® 150^{EVO} F - Algarve®

To enclose the sides of the Algarve®, it can be combined with the Fixscreen® 100^{EVO} Slim F and the Fixscreen® 150^{EVO} F. In this case, the box for the sun protection fabric can be mounted under the frame profiles, meaning that it ties in perfectly with the basic construction.

Technical specifications Fixscreen® EVO		
(mm)	Fixscreen® 100 ^{EVO} Slim (F)	Fixscreen® 150 ^{EVO} (F)
Box (W x H)	110 x 150	155 x 150
Dimensions		
Maximum (W x H) screen	4500 x 2700	6000 x 2700
Bottom bar (W x D)	30 x 53 disappears into the box	
Closed side channel (C) (W x D)	35 x 48	
Deep side channel (D) (W x D)	35 x 110	35 x 150

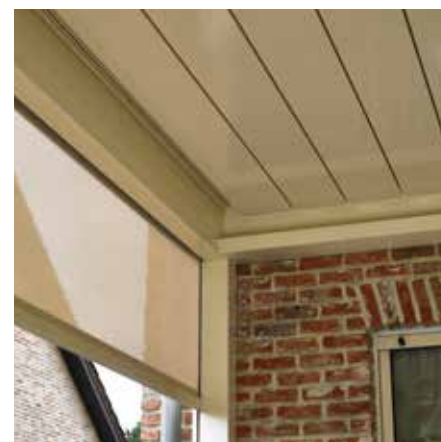





ALGARVE® ROOF

A stylish and functional solution to integrate into your architecture.





It is also the perfect solution for your
apartment terrace.





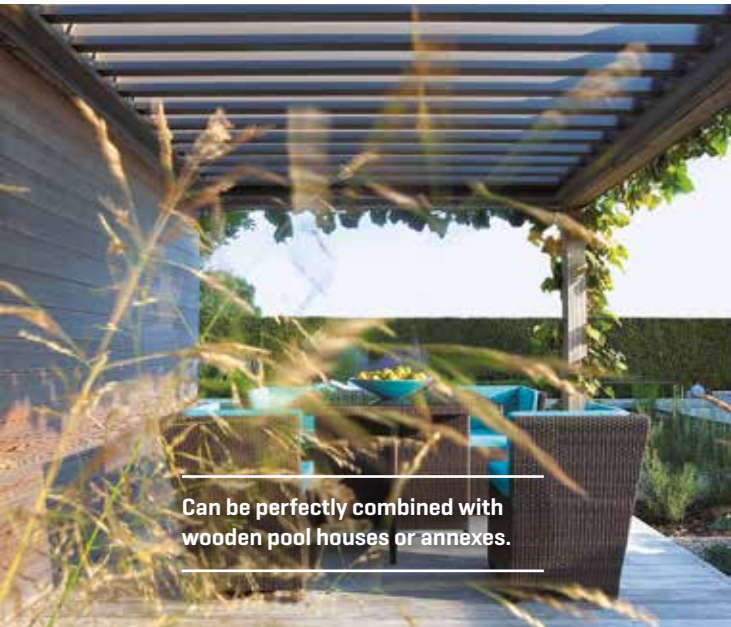



The combination of wooden and aluminium...
perfect harmony.





ALGARVE® ROOF

Innovative and modular terrace covering with horizontal sun protection roof with rotating blades.

Horizontal sun protection roof with adjustable blades can be integrated into existing constructions

This simple roof structure, without columns but with rotating blades, creates a sun protection roof.

The extruded aluminium blades can be rotated up to 150°, thus providing the possibility to determine for yourself how much sun protection and/or ventilation you desire.

The blades form a waterproof roof when closed. The rainwater is carried to the corners via a drainage gutter.

The Algarve® Roof fits in with any architectural style, whether its contemporary, classic or modern, thanks to its elegant, light design and availability in all of the RAL colours.

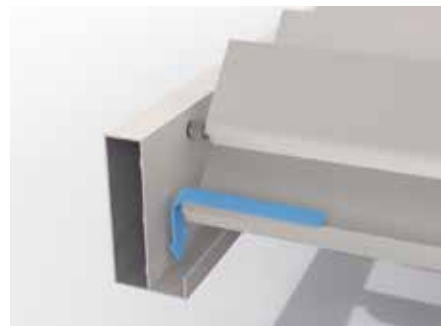

Drainage gutter

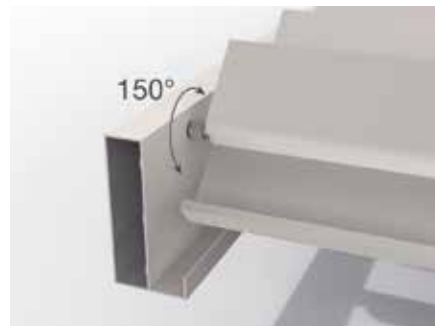

150° rotation

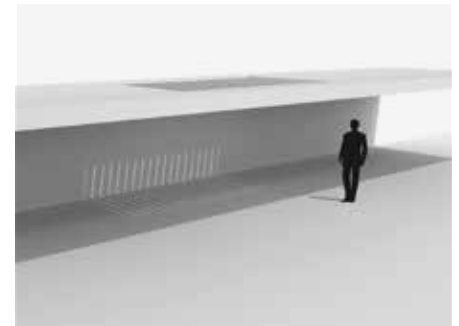

Type of installation 3 - Integration



Type of installation 4 - Surface-mounted

Dimensions and features

Roof options	Rotating aluminium blades
Dimensions	
Max. width/Pivot	6050
Max. depth/Span	4500
Standard passage height	not applicable
Joinable	joinable in two parts up to 6000 mm on the Span side without an additional column
Min. angle	no angle [0°]
Technical specifications	
Integrated water drainage	standard
Integrated cables	standard
Integrated motor	not applicable
Operating switch	option
RTS operation	standard
io-homecontrol® operation	not applicable
Personalisation	
Triangle	not applicable
Glass roof blades - Lineo® Luce	option
Integrated vertical windproof screens	not applicable
Loggiawood sliding door/Loggiascreen 4 ^{FIX} /Loggialu	not applicable
Sliding glass walls	not applicable
Combination of sliding glass walls + integrated windproof	not applicable
Loggiawood sliding wall / Loggiascreen 4 ^{FIX} / Loggialu	not applicable
Windproof screens [surface-mounted] with Fixscreen®100 ^{EVO} Slim F / Fixscreen®150 ^{EVO} F	option
Integrated LED lighting/in the blade or UpDown	option
Beam with Heat & Sound	option



patented technology





LAPURE®

Minimalistic terrace covering with waterproof, windproof and sun protection screen roof, with an open, panoramic view.

Modern



There are two versions. The first has end columns, and the second has a roof overhang that juts out past the columns so as to provide the optimum amount of shade across the entire terrace.

Classic - "Classic Line"



There is no visually disruptive lateral connection when open, which creates a beautiful "infinity view".

Lapure® “Classic Line”**Stylish terrace covering with a classic touch**

The **Lapure®** terrace covering, with a waterproof, transparent screen in the roof, is now available in a “Classic Line” version. The columns of the **Lapure® “Classic Line”** have decorative lines etched into the profile. In addition to this, the columns are finished using a rounded or diamond-shaped element. **Lapure® “Classic Line”** is an aesthetic, designer solution for a rustic or classic home.



LAPURE®

Minimalistic terrace covering with waterproof sun protection screen roof.

The stylish, **minimalistic** Lapure® consists of a windproof, waterproof, sun protection screen roof that rests on elegant, discrete aluminium columns **with no disruptive lateral connection**. It is anchored to an existing façade.

When the roof is closed, the Lapure® provides protection from the sun, wind and rain. When the roof is open, you can enjoy the sun without the **minimalistic structure** disrupting the view.

There are two types of columns for the Lapure®: **“end columns”** with water drainage [via side channels and columns, even when half open]. You can also opt for **“shifted columns”** [with roof overhang and water drainage via gutters, even when half open]. The latter has a roof overhang that juts out past the columns so as to provide the optimum amount of shade. This lets you enjoy enough shade, even when the sun is low in the sky, for instance [installation on west-facing façades].

A **“coupled”** version of both types is also available so that two or more roofs can be installed perfectly next to one another so that they span across larger areas [just 1 column to be joined].

Thanks to the wide range of colours for the structure and the screen fabric, the Lapure® blends in to every environment and suits every architectural style.

1 roof section

Without roof overhang
[with “end columns”]



With roof overhang
[with “shifted” columns]



2 roof sections



3 roof sections



Dimensions and features

Roof options	Retractable waterproof, translucent sun protection screen
Dimensions	
Max. width/Pivot	4000
Max. depth/Span	5000
Max. passage height	2900
Joinable	joinable to max. width of 12 m
Min. angle	10°
Technical specifications	
Integrated water drainage	standard (depending on the type)
Integrated cables	standard
Integrated motor	standard
Operating switch	not applicable
RTS operation	standard
io-homecontrol® operation	option at no extra cost
Personalisation	
Triangle	not applicable
Glass roof blades - Lineo® Luce	not applicable
Integrated vertical windproof screens	not applicable
Loggiawood sliding door/Loggiascreen 4 ^{FIX} /Loggialu	not applicable
Sliding glass walls	not applicable
Combination of sliding glass walls + integrated windproof	not applicable
Loggiawood sliding wall / Loggiascreen 4 ^{FIX} / Loggialu	not applicable
Windproof screens [surface-mounted] with Fixscreen®100 ^{EV0} Slim F / Fixscreen®150 ^{EV0} F	not applicable
Integrated LED lighting	not applicable
Beam with Heat & Sound	not applicable

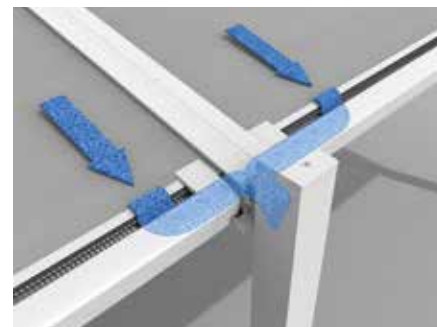

Coupled version with end column

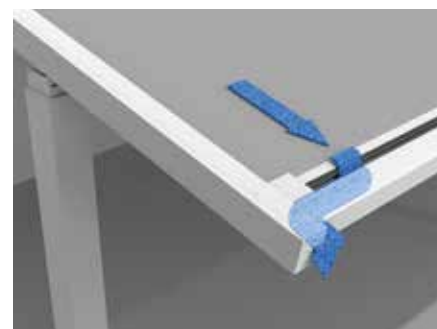

With shifted columns

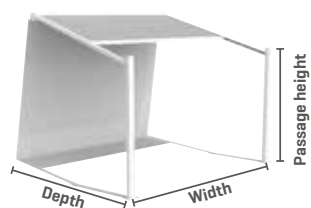

patented technology

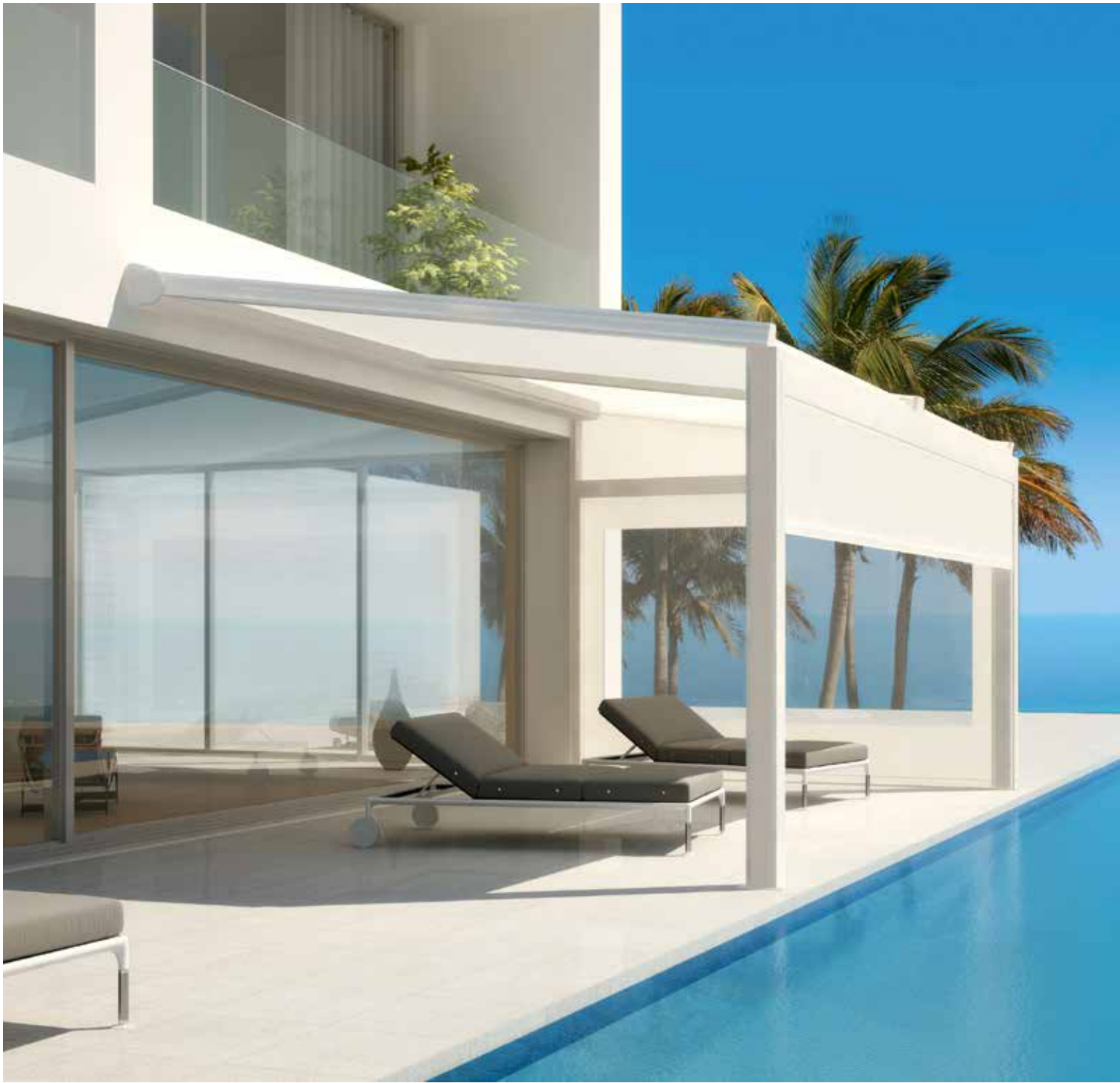



LAGUNE®

Ultimate luxury and wellness on your terrace. Live outside in your stylish and comfortable space throughout the year. Have your terrace roof completely open or closed... You can change it with a single push of a button.

Protected from excessive sunlight or wind
without sacrificing your view of your garden...
Thanks to the integrated Crystal windows.







Depending on where the sun is, your roof elements will open or close as you wish.







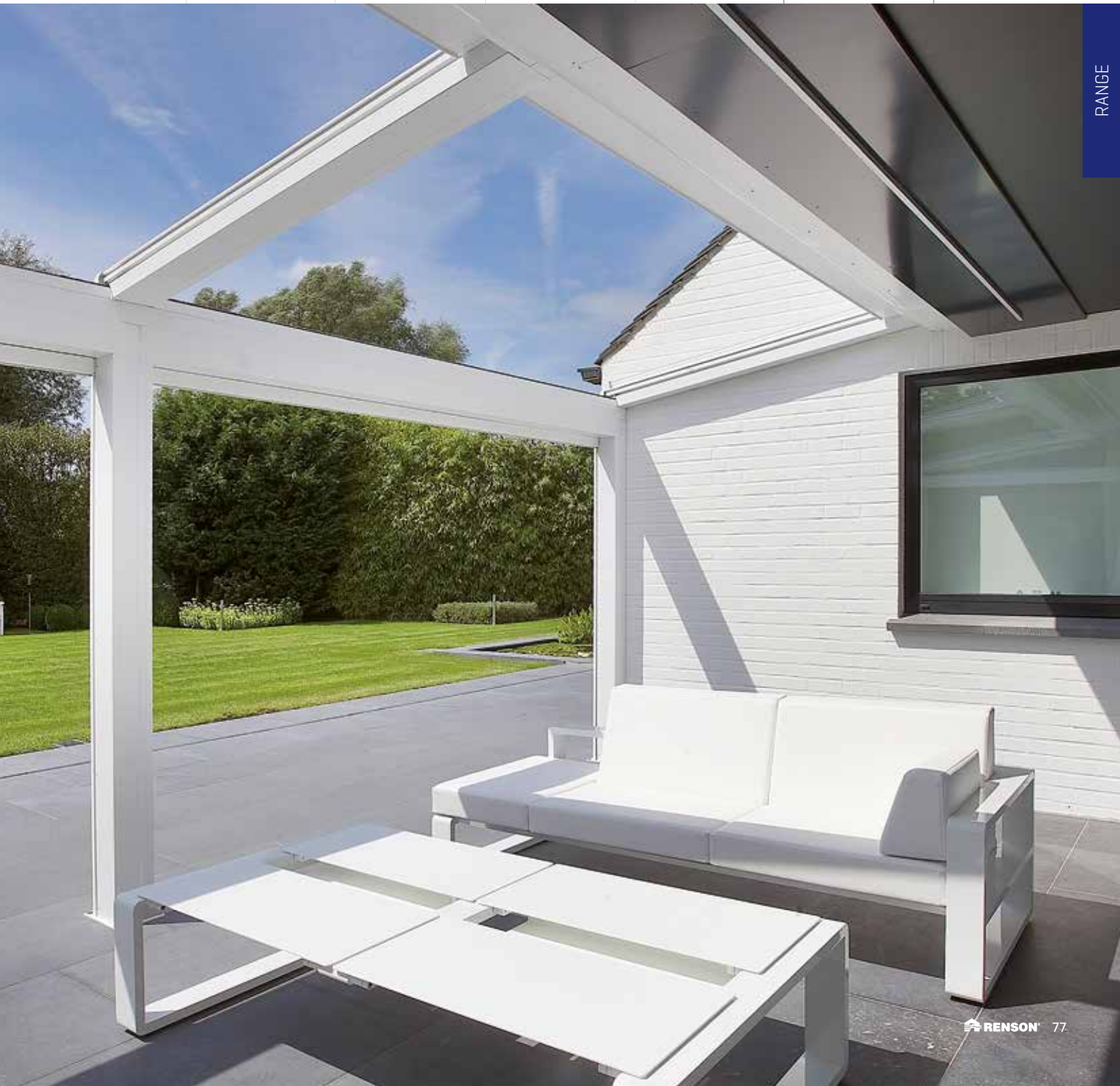

LAGUNE®

Terrace covering with innovative, transparent fabric in the roof structure.

This terrace covering has an **aluminium structure** with **integrated Fixscreen® technology**. The sun protection is completely integrated into the structure, creating an aesthetic unit. Thanks to the modular structure, the entire unit is easy to expand, even afterwards.

The **Fixscreen® technology** combined with **optimum screen tension** ensures that rainwater is drained via the guiding channels hidden within the structure.

Even if the sun protection screen is not fully unrolled, the water that falls on it is drained away via this **integrated water-drainage system**.

A great deal of attention is also given to the **quality of the finish**. For example, the fixation parts are **practically invisible**, all of the electrical cables are hidden and invisible floor mounting is also possible.

Lagune's® high-quality materials and design **keep maintenance to a minimum**, while simultaneously guaranteeing **exceptional sustainability**.

The Lagune® fits in with **any architectural style** thanks to its availability in all of the RAL colours and the various customisation options.



Construction situation 1

Against a supporting construction [standard]



Construction situation 2

Against a supporting, left- and right-side construction



Construction situation 3

Against a supporting and left-side construction



Construction situation 4

Against a supporting and right-side construction



Integrated water drainage



Integrated water drainage

Dimensions and features

Roof options	Retractable waterproof, translucent sun protection screen
Dimensions	
Max. width/Pivot	6000
Max. depth/Span	6000
Max. passage height	2500
Joinable	joinable to max. width of 12 m
Min. angle	8°
Technical specifications	
Integrated water drainage	standard (incl. PVC drainage pipes in column)
Integrated cables	standard
Integrated motor	standard
Operating switch	not applicable
RTS operation	option at no extra cost
io-homecontrol® operation	standard
Personalisation	
Triangle	option
Glass roof blades - Lineo® Luce	not applicable
Integrated vertical windproof screens	option
Loggiawood sliding door/Loggiascreen 4 ^{FIX} /Loggialu	option [Side]
Sliding glass walls	option [Front]
Combination of sliding glass walls + integrated windproof	option [Front]
Loggiawood sliding wall / Loggiascreen 4 ^{FIX} / Loggialu	option [Side]
Windproof screens [surface-mounted] with Fixscreen®100 ^{EV0} Slim F / Fixscreen®150 ^{EV0} F	not applicable
Integrated LED lighting	option
Beam with Heat & Sound	option

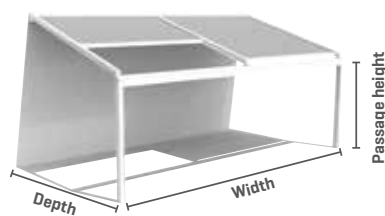

patented technology

There are four basic models, depending on the width of the Lagune®:



Basic model 1

1500mm < width ≤ 4000 mm



Basic model 2

4000mm < width ≤ 6000 mm



Basic model 3

6000mm < width ≤ 8000 mm



Basic model 4

8000mm < width ≤ 12000 mm

Personalisation possibilities

Lagune® can have various elements fitted to the front and/or sides. By adding side elements you create infinite possibilities for personalisation.



Triangle®



Integrated Fixscreen®



Lagune® is fitted with multiple integrated Fixscreens® in the Front



Loggia® sliding panel: Loggiawood, Loggiawood Privacy, Loggiascreen 4^{FX}, Loggialu, Loggialu Privacy



Loggia® easy passage: Loggiawood, Loggiascreen 4^{FX}, Loggialu

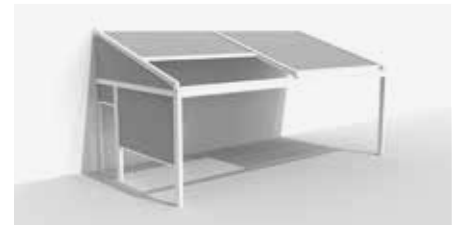

Lagune® is fitted with multiple integrated Fixscreens® in the Side



Sliding glass walls



Sliding glass walls + Integrated Fixscreen®

Integrated Fixscreen®

By integrating the vertical sun protection, the integrated Fixscreen®, with or without Crystal windows to keep a view of the outside, you can create an extra outdoor room where the users are protected from sun, rain and wind. These screens come in 50 colours and allow you to **personalise** the Lagune® and create the atmosphere you desire.

Triangle - Lagune®

In order to make the integration possible in the Lagune® Side, it is necessary to fit this with the Lagune® Triangle.
Lagune® is fitted with a vertical wall profile

and an additional box in this case. The triangle that is created between the Lagune's® box and side channel is filled with a fibreglass fabric of your choosing.







TOSCANE® NEW!

The sliding, folding roof of this sleek, modular terrace covering is operated using patented technology. Toscane® was specially developed for large terraces of up to 6,5 m x 13 m with a single-fabric screen roof.





TOSCANE®

Sleek, modular terrace covering with a sliding, folding roof operated using patented technology.

Toscane® is waterproof, windproof sun protection with an integrated drainage system.

Large dimensions, with a maximum width of 6500 mm projection x 13000 mm width with a single-fabric screen roof, are available, which makes this product perfect for use in the hotel and catering industry.

Toscane® can have an angle of inclination from 4,5° to 20°, depending on the span.

Moreover, different side variation integrations, including Fixscreen®, glass walls and Loggia sliding panels, are possible. Various types of roof screens are available.

Toscane® is available with integrated LED lighting to create sustainable, soft lighting.

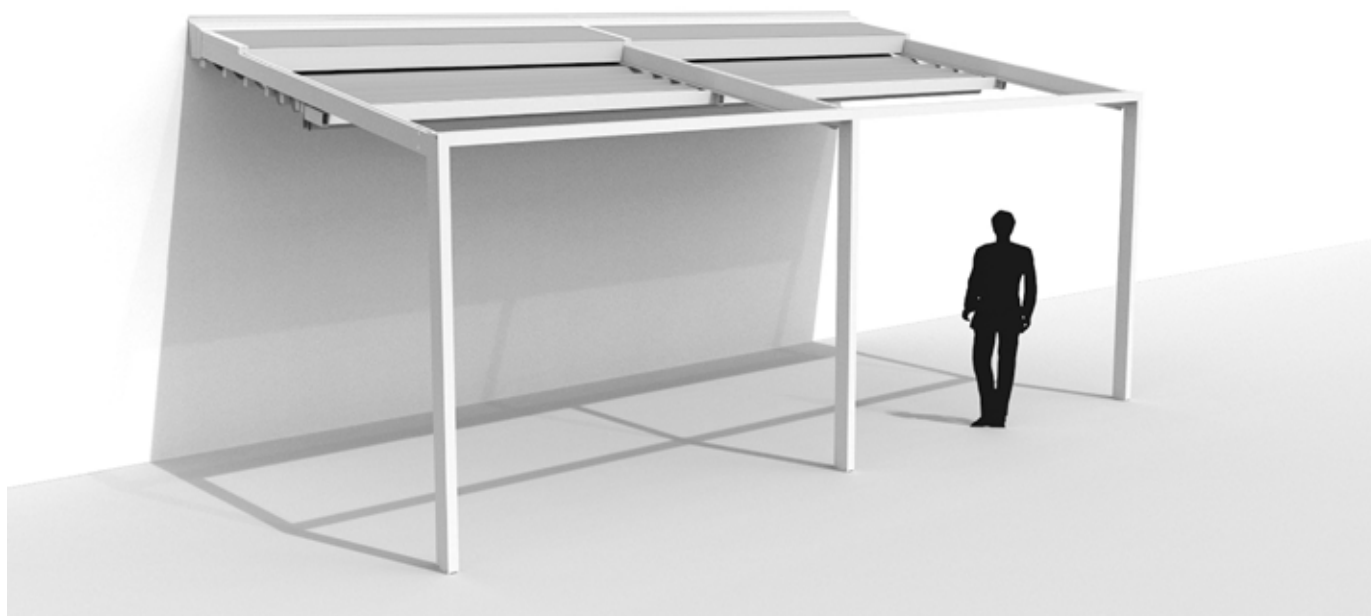

Dimensions and features

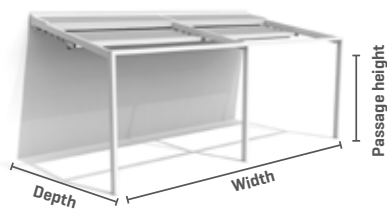

Roof options	Aluminium terrace covering with folding roof
Dimensions	
Max. width/Pivot	4500
Max. depth/Span	6500
Max. passage height	2500
Joinable	joinable up to 13 m with a single-fabric
Min. angle	starting at 4,5° [depending on the width]
Technical specifications	
Integrated water drainage	standard
Integrated cables	not applicable
Integrated motor	standard
Operating switch	not applicable
RTS operation	standard [Somfy external receiver]
io-homecontrol® operation	not applicable
Personalisation	
Triangle	option
Glass roof blades - Lineo® Luce	not applicable
Integrated vertical windproof screens	option [Front]
Loggiawood sliding door/Loggiascreen 4 ^{FIX} /Loggialu	not applicable
Sliding glass walls	option
Combination of sliding glass walls + integrated windproof	option [Front]
Loggiawood sliding wall / Loggiascreen 4 ^{FIX} / Loggialu	option [Front]
Windproof screens [surface-mounted] with Fixscreen®100 ^{EV0} Slim F / Fixscreen®150 ^{EV0} F	option [Side]
Integrated LED lighting	option
Beam with Heat & Sound	not applicable

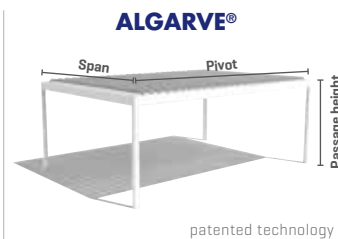
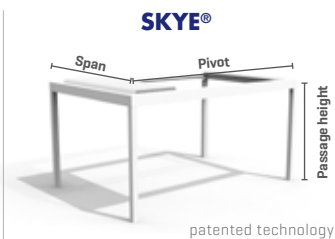
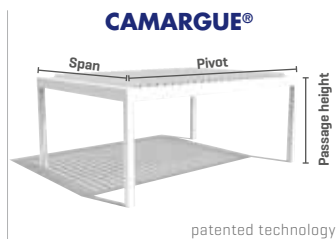

patented technology

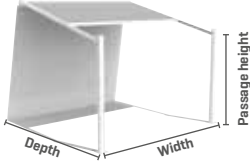
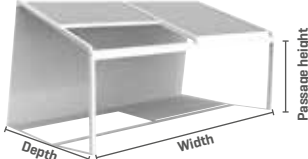

Roof options	Rotating aluminium blades	Rotating, retractable aluminium blades	Rotating aluminium blades
DIMENSIONS			
Max. width/Pivot	6200	6200	6050
Max. depth/Span	4500	4500	4500
Max. passage height	2800	2800	2800
Joinable	joinable with multiple parts	joinable with multiple parts on the Span side	two-part joinable
Min. angle	no angle [0°]	no angle [0°]	no angle [0°]
TECHNICAL SPECIFICATIONS			
Integrated water drainage	standard (Incl. PVC drainage pipes in column)	standard (Incl. PVC drainage pipes in column)	standard
Integrated cables	standard	standard	not applicable
Integrated motor	standard	standard	not applicable
Operating switch	not applicable	not applicable	option
RTS operation	standard	not applicable	standard
io-homecontrol® operation	not applicable	not applicable	not applicable
PERSONALISATION			
Triangle	not applicable	not applicable	not applicable
Glass roof blades - Lineo® Luce	option	not applicable	option
Integrated vertical windproof screens	option	option	not applicable
Loggiawood sliding door/ Loggiascreen 4 ^{FIX} /Loggialu	option	option	not applicable
Sliding glass walls	option	option	not applicable
Combination of sliding glass walls + integrated windproof	option	option	not applicable
Loggiawood sliding wall/ Loggiascreen 4 ^{FIX} /Loggialu	option	option	not applicable
Windproof screens [surface-mounted] with Fixscreen®100 ^{EV0} Slim F / Fixscreen®150 ^{EV0} F	not applicable	not applicable	option
Integrated LED lighting	option	option	option
Beam with Heat & Sound	option	option	option

 <p>ALGARVE® ROOF</p> <p>patented technology</p>	 <p>LAPURE®</p> <p>patented technology</p>	 <p>LAGUNE®</p> <p>patented technology</p>	 <p>TOSCANE®</p> <p>patented technology</p>
Rotating aluminium blades	Retractable waterproof, translucent sun protection screen	Retractable waterproof, translucent sun protection	Aluminium terrace covering with folding roof
6050	4000	6000	4500
4500	5000	6000	6500
not applicable	2900	2500	2500
two-part joinable	joinable to max. width of 12 m	joinable to max. width of 12 m	joinable up to 13 m with a single-fabric screen
no angle [0°]	10°	8°	starting at 4,5° (depending on the width)
standard	standard (depending on the type)	standard [Incl. PVC drainage pipes in column]	standard
not applicable	standard	standard	not applicable
not applicable	standard	standard	standard
option	not applicable	not applicable	not applicable
standard	standard	option at no extra cost	standard
not applicable	option at no extra cost	standard	not applicable
not applicable	not applicable	option	option
option	not applicable	not applicable	not applicable
not applicable	not applicable	option	option [Front]
not applicable	not applicable	option	not applicable
not applicable	not applicable	option	option
not applicable	not applicable	option	option [Front]
not applicable	not applicable	option	option [Front]
option	not applicable	not applicable	option [Side]
option	not applicable	option	option
option	not applicable	option	not applicable



music

heating element

lighting

sliding glass wall

sun protection fabric

Loggia wood
sliding panel



ACCESSORIES

Create the terrace covering that you want.
Accessories that meet everyone's comfort and needs are available.

WEATHER-RESISTANT

Can be closed to stop out rain and wind

Lapure® and **Lagune®** are terrace coverings with waterproof, transparent sun protection screens. The Fixscreen® technology combined with optimum screen tension ensures that rainwater is drained off via hidden channels. Even if the sun protection screen

is not fully unrolled, the water that falls on it is drained away via this integrated water-drainage system.

Camargue®, Algarve® and **Algarve® Roof** are terrace coverings with rotating blades in

the roof. These patented blades are designed in such a way that the water is drained off to the side even if the blades open up after it rains.

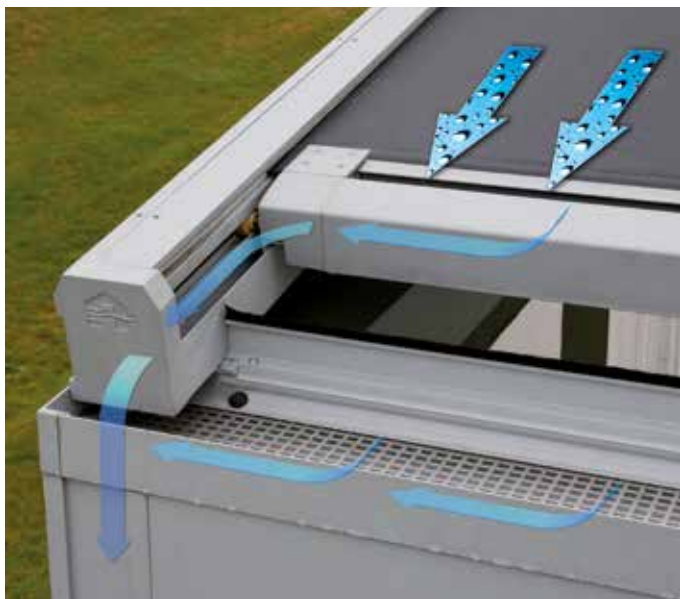

Lagune® can drain an amount of water equivalent to rains with an intensity of 180 mm/hr that last up to 2 minutes. These kinds of rains occur on average once every 15 years in Belgium. [See Belgian rain statistics: NBN B 52-011 norm]

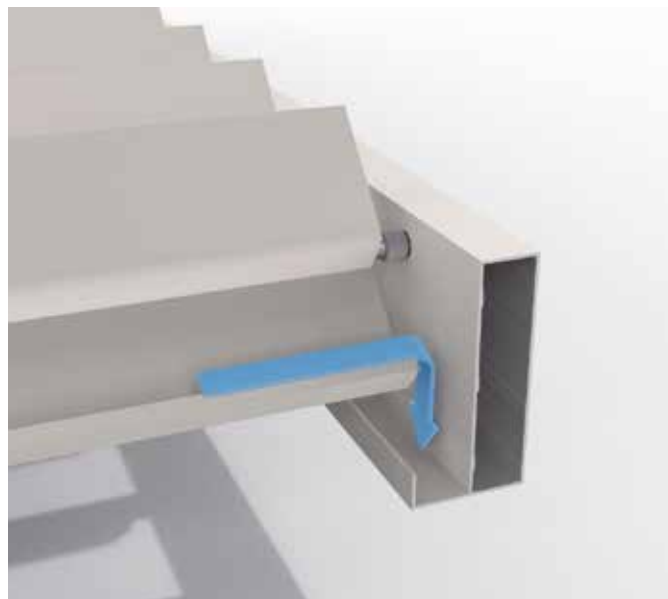

Algarve® can drain an amount of water equivalent to rains with an intensity of between 144 mm/hr and 180 mm/hr that last up to 2 minutes. These kinds of rains occur on average once every 10 years in Belgium. [See Belgian rain statistics: NBN B 52-011 norm]



Camargue® can drain an amount of water equivalent to rains with an intensity of 180 mm/hr that last up to 2 minutes. These kinds of rains

occur on average once every 15 years in Belgium. [See Belgian rain statistics: NBN B 52-011 norm]

LIGHTING, HEATING AND MUSIC

Enjoy every moment of the day.

When it starts to get dark, you simply switch on the integrated **lighting**. The choice of lighting lets you create the desired mood and feeling.

You can continue to enjoy your terrace, even when it starts getting colder. **Heating elements** can be provided to make this possible. The radiated heat ensures an even distribution of warmth throughout the space with a minimum of heat loss.

Thanks to the integrated flat panel speakers, you can even enjoy your favourite **music** on your terrace.



A | LIGHTING

You can choose between cool or warm lighting to create the desired mood and feeling. Moreover, the LED lighting in most coverings can be **dimmed** so that the intensity of the lighting can be adjusted to the situation. The lighting for **Lagune®** and **Toscane®** is integrated into the roof structure.

You can opt for LED lighting that is integrated into the roof blades in **Camargue®**, **Algarve®** and **Algarve® Roof**. Upwards or downwards lighting can also be provided on the inside of the frame. It is also possible to integrate atmospheric lighting into the **Camargue®** and **Skye®** columns.

You can choose between warm white light [perfect for cosy gatherings with friends], pure

white light [perfect for reading] and RGB [only for uplighting in the frame] to create the desired mood and feeling. Moreover, the LED lighting can be dimmed so that the intensity of the lighting can be adjusted to the situation. The RENSON® LED lighting's exceptionally sustainable quality ensures even lighting without any bright spots.

BEAM - design beam:

- Dimensions: H 165 mm x D 47 mm
- The angle of inclination is 30° adjustable without extra steps
- Width equals that of the covering

HEAT - heating elements:

- Dimensions: H 160 mm x W 1,284 mm
- 12 ampere/heating element
- 2600 W/heating element
- Waterproof IP65

SOUND - Loudspeakers:

- Dimensions: H 160 mm x W 160 mm
- Flat Panel Speakers with "Plane Wave" Technology
- 25 W RMS/50 W peak capacity
- Waterproof IP65

LED lighting:

- Warm white light [3000K] [perfect for creating ambiance, cosy gatherings, etc.]
- Pure white light [5000K] [perfect for reading, etc.]
- RGB

The LEDs can be dimmed.

	Warm white light	Pure white light	RGB [colour]
Lagune® Light	✓	✓	
Lineo® LED*	✓	✓	
Colomno LED**	✓	✓	
UpDown LED** Upwards	✓	✓	✓
UpDown LED** Downwards	✓	✓	
Toscane® Light	✓	✓	

* Warm white: 2100 lm/m [180 LED's/m]

Pure white: 2340 lm/m [180 LED's/m]

** Warm white: 550-680 lm/m [120 LED's/m]

Pure white: 550-680 lm/m [120 LED's/m]

RGB: 570-700 lm/m [60 LED's/m]

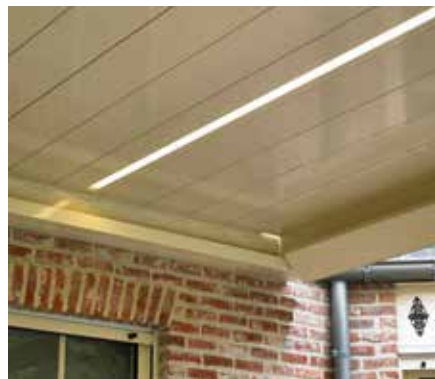
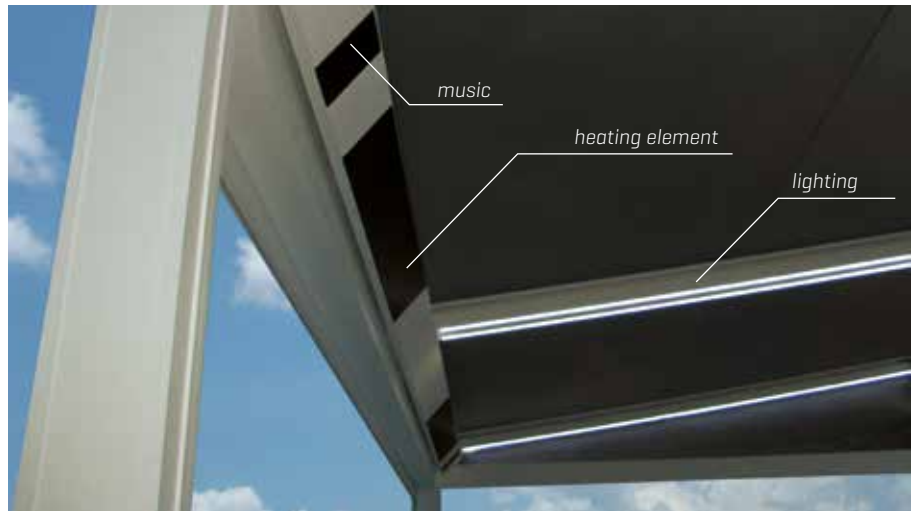



Colomno LED

LED lighting integrated into the **Camargue®** and **Skye®** columns. A maximum of one LED strip can be integrated into each column (on the inside of the column). There can be a total of four columns fitted with integrated LED lighting per roof section.



Integrated column lighting



Lagune® Light

Integrated LED lighting in the side channels of the Rooffix - **Lagune®**.



UpDown LED

Integrated LED lighting in the inside of the frame. Fitted with lighting running upwards and/or downwards. This lets you create indirect or direct atmospheric lighting with the **Camargue®, Skye®** and **Algarve®**. A total of two UpDown LED lighting modules can be installed per roof section. This can only be done on either the Pivot side or the Span side.



Uplighting
Downlighting



Lineo LED

Integrated LED lighting in the blades - **Camargue®, Algarve®**. Even distribution without visible bright spots thanks to high-quality LEDs (180 per metre).



Toscane® Light

Integrated pure or warm white LED lighting in the roof screen profiles.



B | HEATING AND LOUDSPEAKERS

Integrated LED lighting, heating and sound are the perfect addition to **Camargue®**, **Skye®**,

Algarve®, **Algarve® Roof** and **Lagune®**. Thanks to these extra features, the terrace can be used from early morning to late evening, all year round.

The Beam is also available separately. Moreover, these additions can be perfectly integrated afterwards.

the **Beam** design beam with **Heat & Sound**



Integrated heating elements and loudspeakers.



Heated enclosures

To enjoy your heater to the fullest, we recommend adding components (such as glass walls, Fixscreen®, etc.) that will enclose the terrace covering.



Perfect heater position

The perfect position for the heater is across from the fixed wall so that you can enjoy the reflected heat.

SIDE ELEMENTS (CAMARGUE®, ALGARVE®, SKYE®, LAGUNE® AND TOSCANE®)

Endless personalisation options

Camargue®, **Lagune®** and **Toscane®** can have various elements (such as sun protection fabric, sliding panels, glass walls, etc.) fitted to the front and/or sides. This results in endless personalisation options.

The front and/or the sides of the **Algarve®** can be fitted with vertical sun protection.

Lowered windproof, motorised Fixscreens® create a protective cocoon. Thanks to the partial transparency of the screens and the use of Crystal windows, you don't lose the view of the garden.

You've also got a wide range of colours to choose from. Every colour combination is possible and can perfectly be combined with other materials, such as the garden furniture. In the open position, the **integration of the screens is invisible** and the motors are also completely concealed in the structure.

You can also opt for **sliding glass walls**. When combined with windproof screens, you also retain the benefit of sun protection.

Elegant **Loggia® sliding panels with wind-proof screen fabrics or (adjustable or fixed) wooden or aluminium blades** are also an option. Wood (particularly cedar) has made a comeback and is easy to combine with other materials.

You can even opt for a two-toned colour finish when you combine sliding panels with aluminium blades.



ACCESSORIES

SLIDING GLASS WALLS (CAMARGUE®, SKYE®, LAGUNE® AND TOSCANE®)

Increased elegance thanks to completely transparent sliding walls.

You can also choose to install sliding glass walls. These completely transparent sliding walls increase the elegance of the **Camargue®**, **Skye®**, **Lagune®** and **Toscane®**. This also protects you from the weather and wind, and the terrace covering can be completely enclosed to prevent theft.

You can of course always integrate the vertical, windproof Fixscreen® sun protection together with a sliding glass wall, which keeps the major advantage of sun protection.

In addition to the vertical, windproof Fixscreen® sun protection, you can also opt to integrate sliding glass walls. In this development, special attention was given to easy installation and perfect integration, while still allowing this to be combined with the integrated Fixscreen®. This allows the main advantage of sun protection to be maintained in addition to other important benefits, such as lockable to prevent theft and protection from weather & wind.

These completely transparent sliding walls increase the elegance of the **Camargue®**, **Skye®**, **Lagune®** and **Toscane®**.

Integration

the **Camargue®** and **Skye®**:
possible in Span and/or Pivot
Lagune® and **Toscane®**:
possible in Side and/or Front





The Camargue® is fitted with sliding glass walls and integrated Fixscreens® in the Span and Pivot side



The Lagune® is fitted with sliding glass walls in the Side and Front

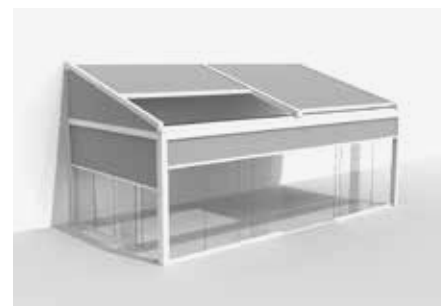

The Lagune® is fitted with sliding glass walls and integrated Fixscreen® in the Side and Front

Distribution of sliding glass walls

1500 ≤ X ≤ 2500 Width X	2500 < X ≤ 3750 Width X	3750 < X ≤ 5250 Width X	5250 < X ≤ 6500 Width X
3 panels	4 panels	6 panels	8 panels
3 rails	4 rails	3 rails	4 rails
Opens to the left Or opens to the right	Opens to the left Or opens to the right	Opens to the left and opens to the right	Opens to the left and opens to the right
Incl. 1 handle	Incl. 1 handle	Incl. 2 handles	Incl. 2 handles

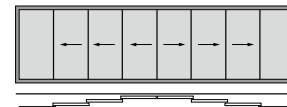
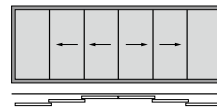
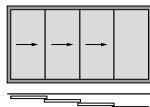
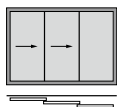

LOGGIA® SLIDING PANELS (CAMARGUE®, SKYE®, LAGUNE® AND TOSCANE®)

You control the amount of light that comes in

With the vertical sun protection sliding panels, we can even influence the way sunlight penetrates under your terrace covering (dynamic sun protection). The sliding sun protection panels are made of aluminium frames with:



aluminium blades: Loggialu



wooden blades: Loggiawood



sun protection fabric: Loggiascreen 4^{FIX}

Privacy

Manually adjustable wooden or aluminium blades.

The **Privacy** version of the Loggiawood and Loggialu sliding panels have manually rotatable blades that go from completely closed to completely open (can also be used with **Camargue**®).



Types

- Loggiawood: wooden blades (WR Cedar)
- Loggiawood Privacy: rotating wooden blades (WR Cedar)
- Loggiascreen 4^{FIX}: fabric screen (fibreglass)
- Loggialu: aluminium blades
- Loggialu Privacy: rotating aluminium blades

Integration

Camargue® and **Skye**®: available in Span and/or Pivot

Lagune®: available in Side

Toscane®: available in Front



Camargue® fitted with Loggiawood® sliding wall on the Span side



Lagune® fitted with Loggiawood® sliding wall on the side

LOGGIA® EASY PASSAGE/SLIDING DOOR (NOT AVAILABLE WITH TOSCANE®)

Perfect for when the terrace covering is completely enclosed (using Fixscreen®, for instance) and you want to have easy passage from in or out of the terrace covering without having to open the Fixscreen® [the comfort of those sitting under the terrace covering is maintained].

Types

- Loggiawood: wooden blades (WR Cedar)
- Loggialu: aluminium blades
- Loggiascreen 4^{FIX}: fabric screen (fibreglass)

Integration

Camargue® and **Skye®**: available in Span and/or Pivot

Lagune®: available in Side and/or Front

Width: min. 800 mm – max. 1200 mm



Camargue® fitted with an integrated Fixscreen® and sliding door using the Loggiascreen 4^{FIX} in the Span side

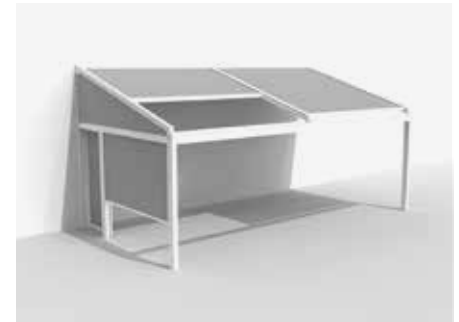

Lagune® fitted with an integrated Fixscreen® and sliding door using the Loggiascreen 4^{FIX} in the Side



Lagune® fitted with an integrated Fixscreen® and sliding door using the Loggiascreen 4^{FIX} in the Front



INTEGRATED FIXSCREEN® (CAMARGUE®, SKYE®, LAGUNE® AND TOSCANE® FRONT)

Perfect integration, even afterwards!

Perfect for:

- Privacy
- Shade when the sun is low in the sky
- Protection from wind, rain and insects

Thanks to an ingenious zipper system, the fabric is windproof in every position and is insect-proof when closed. It is an incredibly well-thought-out principle in which the sun protection fabric has a special zippered trim. This ensures that the entire structure is held firmly by the two side channels.

The integration of this Fixscreen®, whether or not there are Crystal windows to maintain the view, lets you create another outdoor space where you are protected from the sun, rain

and wind. These screens come in 50 colours and allow you to customise the **Camargue®**, **Skye®**, **Lagune®** and **Toscane®** and create the atmosphere you desire.

The frame profiles are developed in such a way that the bottom bar is aesthetically hidden away in the box when the screen is raised.

Connect&Go® technology

The integrated Fixscreen® is fitted with our patented Connect&Go® technology. This new development provides an enormous advantage for installation, as well as for removing the fabric roller when replacing a screen or motor.



Bottom bar disappears into the Camargue® box



FIXSCREEN® BASE (ALGARVE® AND TOSCANE® SIDE)

Enclosing the sides

To enclose the sides of the **Algarve®** or **Toscane®**, they can be combined with the Fixscreen® 100^{EVO} Slim F or the Fixscreen® 150^{EVO} F. In this case, the box for the sun protection fabric can be mounted on the frame profiles, meaning that it ties in perfectly with the basic construction.



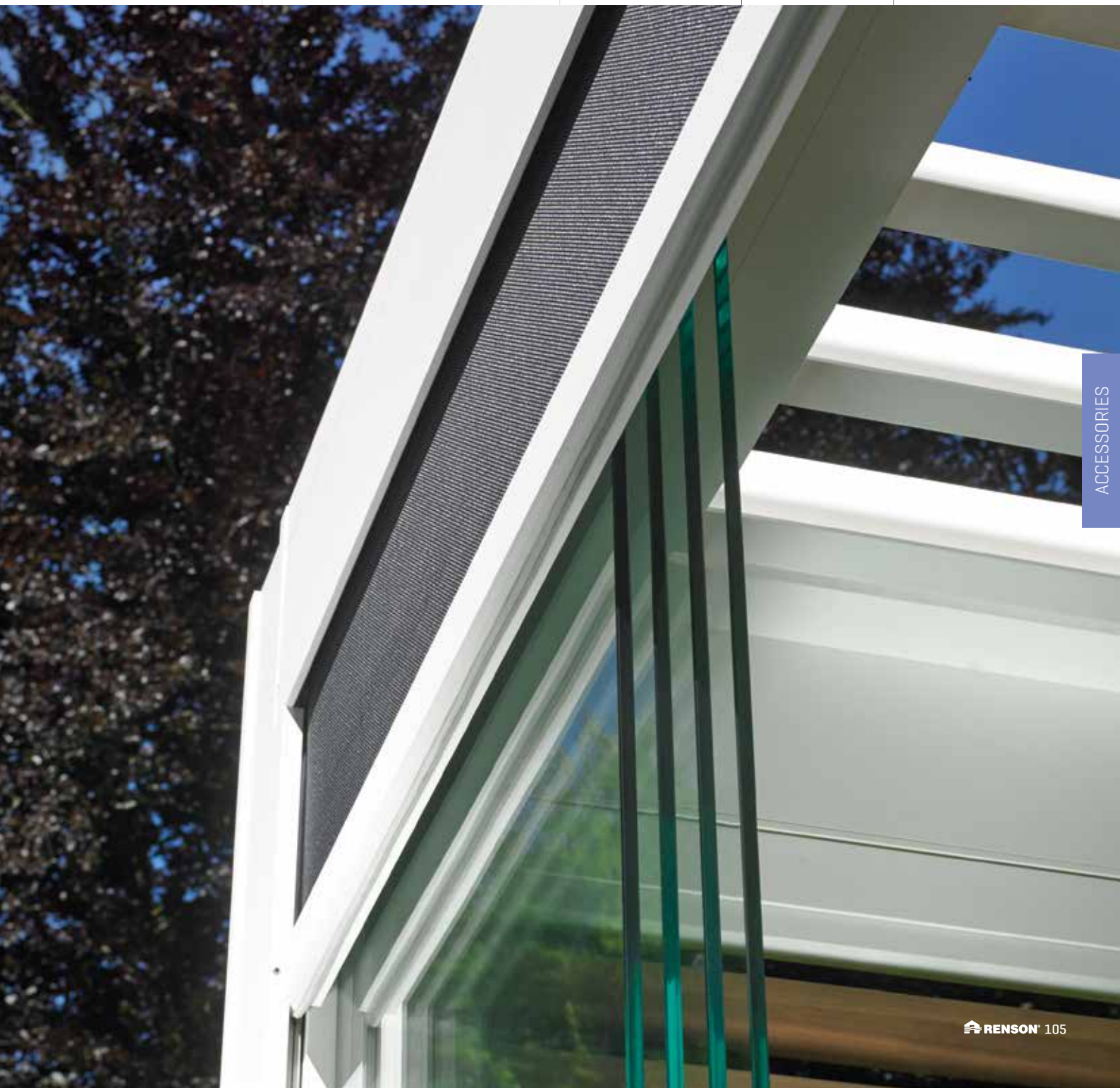

ACCESSORIES

FIXSCREEN® FIBREGLASS FABRICS (CAMARGUE®, ALGARVE®, SKYE®, LAGUNE® AND TOSCANE®)

Transparent sun protection fabric

The best choice in transparent sun protection fabric for windproof vertical sun protection is fibreglass fabric. Fibreglass fabrics score the highest in terms of tension and rigidity, and are also highly resistant to moisture and heat, all while maintaining the view.

We offer a wide range of colours so that you can find the fabric that suits you perfectly.

The "Architects' Selection" is a range of colours that are very popular in the current design and architecture trends. Our RENSON® Ambassadors will be happy to assist you in making your choice.

The fibreglass fabrics are also available with a Crystal window, providing a crystal-clear view.

CRYSTAL WINDOWS

Optimum contact with the outdoor space

In order to maintain the highest level of contact with the space outside the covering, transparent Crystal windows in integrated Fixscreen® fibreglass fabric can be installed. This transparent type of fabric is made from PVC [Fire classification M2]. The Crystal fabric is welded into a fibreglass screen using high-frequency welding. This fabric can be used in the integrated Fixscreen®, Fixscreen® 100^{EVD} Slim F and the Fixscreen® 150^{EVD} F.

There are various options where you can choose between three types of windows:

- One window of 1200 mm by min. 1200 mm
- 2 windows* next to each other
- 2 windows* one above the other

A total of two Crystal windows can be installed per screen. There must be a minimum distance of 200 mm between the sides of the fabric and between the Crystal windows themselves. There must be a distance of 400 mm between the Crystal windows and the bottom and the top edges of the fabric.

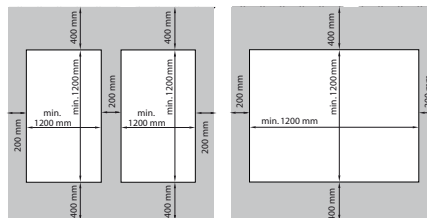

* Either the height or the width must be 1200 mm. The other dimensions must be a min. of 1200 mm.





ACCESSORIES



TRANSPARENT BLADES - LINEO® LUCE (CAMARGUE®, ALGARVE® AND ALGARVE® ROOF)

Increased elegance thanks to completely transparent blades.

RENSON® offers the option to integrate transparent glass blades, specifically Lineo Luce, into the **Camargue®**, **Algarve®** and **Algarve® Roof**, when these have adjustable aluminium blades.

When you fit part of your terrace covering with translucent blades, you create a sense of more openness. This is a way to bring more light inside when adding on to your home.

A total of five transparent blades can be installed per roof section. These can either be put all together or spread out across the whole of the roof section.

The perfect solution for letting the light in even when the roof is closed!





Light in the home with the roof closed.



Light under the terrace covering with the roof closed.



RENSONSCREEN® WATERPROOF (LAPURE®, LAGUNE® AND TOSCANE®)

Innovative roof screen

The **Lapure®**, **Lagune®** and **Toscane®** roofs are fitted with an innovative, waterproof, transparent sun protection screen. One side of this polyester screen is coated with UV-resistant, waterproof coating. This screen is available in various colours.

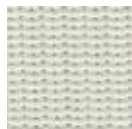

SWC M005



SWC M006



SWC M652



SWC M654

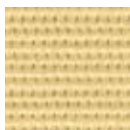

SWC M711

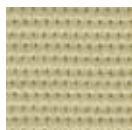

SWC M712



SWC M715

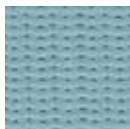

SWC M721



SWC M939



SWC X392*



SWC X393*

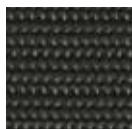

SWC X391*



COLOUR SELECTION ALUMINIUM

Available in all standard RAL colours

Our terrace coverings are powder-coated with “**Seaside quality**” pretreatment as standard. The products are available in all RAL colours in architectural textured finishes at no extra cost.

RENSON® recommends using architectural textured coatings to get an architectural, contemporary look. Moreover, architectural textured coatings are better suited for use outside and scratches are less visible.







AUTOMATION

Easy remote operation

You can operate your terrace covering easily using Somfy automation. You can operate the roof and/ or the screens of your terrace covering by remote control. Depending on the desired use and the number of screens, you can choose from several different remote controls.

Thanks to TaHoma, the new Somfy user interface, your terrace covering can be operated from your smartphone, tablet or computer.

We recommend installing rain and/or wind sensors for an optimum level of comfort.



somfy.

TESTS

Protection and comfort

Our terrace coverings offer protection and comfort at various levels. In order to guarantee this comfort, they are thoroughly tested for water resistance, load-bearing capacity and wind resistance.

Water tested

The water resistance and water drainage are tested using a spray installation that mimics rain. For example, we check the how much flow our terrace coverings can drain and how this drainage can be optimised:

Camargue®: Camargue® can drain an amount of water equivalent to rains with an intensity of 180 mm/hr that last up to 2 minutes. These kinds of rains occur on average once every 15 years in Belgium. [See Belgian rain statistics: NBN B 52-011 norm]

Algarve®: Algarve® can drain an amount of water equivalent to rains with an intensity of between 144 mm/hr and 180 mm/hr that last up to 2 minutes. These kinds of rains occur on average once every 10 years in Belgium. [See Belgian rain statistics: NBN B 52-011 norm]

Lagune®: Lagune® can drain an amount of water equivalent to rains with an intensity of 180 mm/hr that last up to 2 minutes. These kinds of rains occur on average once every 15 years in Belgium. [See Belgian rain statistics: NBN B 52-011 norm]



Load-bearing capacity

Terrace coverings are subjected to external various forces [e.g. snow]. The load-bearing capacity is determined using static strength calculations carried out by our engineers and validated through internal tests. The basic principle is that the construction may bend 1/200th of its longest dimension without permanent deformities occurring.

The load-bearing capacity of the **Camargue®** and **Algarve®** is dependent on the basic structure and the surface area. Using the following diagram, the load-bearing capacity depending on the Span & Pivot dimensions are given.

Example: a terrace covering with a 3375 mm Span and a 5835 mm Pivot can bear a snow load of at least 110 kg/m² [= 2160 kg!]

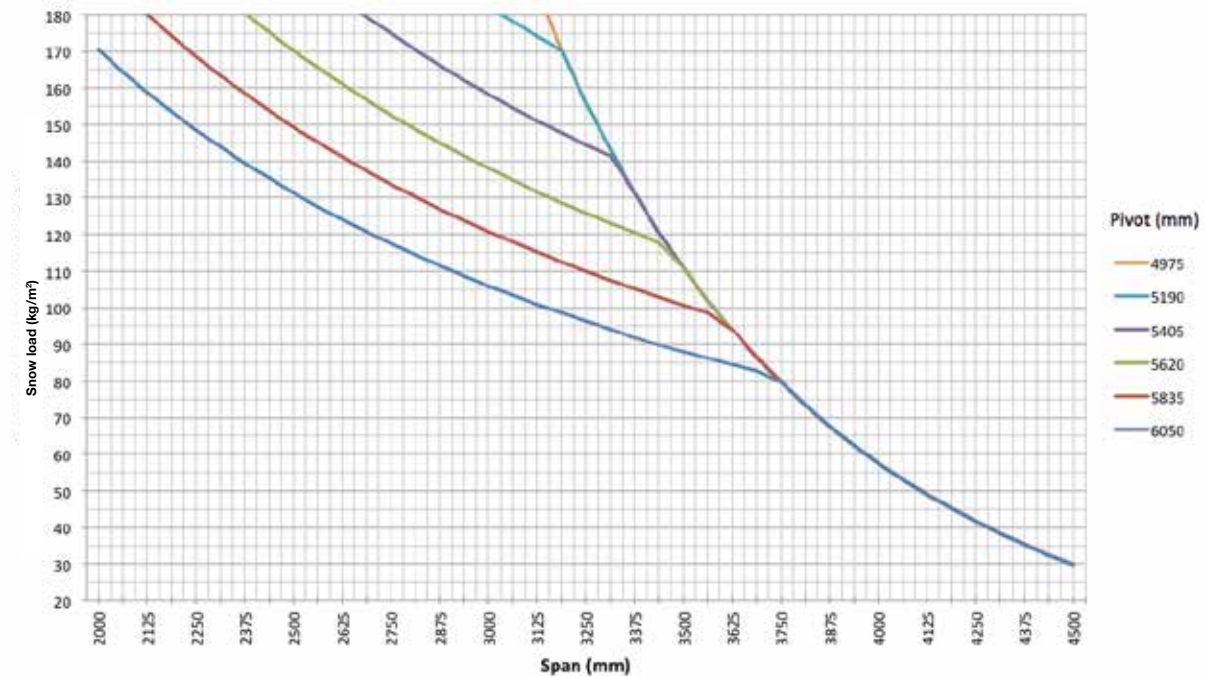

Camargue® and Algarve® load-bearing capacity

Wind tests

In order to determine the wind forces that our terrace coverings and vertical sun protection screens can withstand, wind tunnel tests were carried out.

	Warranty when closed blades/fabric valid up to	Blades/fabric need to be close when wind speeds reach
Camargue Algarve	120 km/h 11 Beaufort	50 km/h 7 Beaufort
Lagune	120 km/h 11 Beaufort	50 km/h 7 Beaufort
Lapure	100 km/h 10 Beaufort	50 km/h 7 Beaufort
Geïntegreerde Fixscreen	60 km/h 7 Beaufort	30 km/h 5 Beaufort



Beaufort scale

Beaufort	Description	Average speed in m/s	Average speed in km/h	Results
0	Calm	< 0,2	< 1	You don't feel the wind. Smoke will rise virtually straight up.
1	Light air	0,3 - 1,4	1 - 5	Wind direction can be read from the smoke plume, but not from the weather vane.
2	Light breeze	1,5 - 3,4	6 - 12	Wind can be felt on the face, leaves rustle, the weather vane moves visibly with the wind.
3	Gentle breeze	3,5 - 5,4	13 - 19	Flags wave and leaves move about constantly
4	Moderate breeze	5,5 - 7,4	20 - 27	Dust blown up irritates eyes. Hair is awry.
5	Fresh breeze	7,5 - 10,4	28 - 37	Bushes rustle, white tops on lakes and canals.
6	Strong breeze	10,5 - 13,4	38 - 48	Umbrellas are difficult to hold on to, large branches sway, power lines hum
7 FIXSCREEN®	High wind, moderate gale, near gale	13,5 - 17,4	49 - 62	It is difficult to walk into the wind. Trees sway.
8	Gale, fresh gale	17,5 - 20,4	63 - 73	Making headway is very difficult. Small branches break off.
9	Strong/severe gale	20,5 - 24,4	74 - 87	Chimney tops, roofing tiles and antennas blow away.
10 LAPURE®	Storm, whole gale	24,5 - 28,4	88 - 102	Adults blow over. Major damage to buildings.
11 CAMARGUE®, ALGARVE®, SKYE®, LAPURE® AND LAGUNE®	Violent storm	28,5 - 32,4	103 - 117	Major damage to houses and forests.
12	Hurricane force	> 32,5	> 118	Total destruction

WARRANTY*

High quality

All of the materials we use are of high quality and have been modified for the intended purposes. As manufacturer, we guarantee:

- 5-year* warranty on all defects arising from normal use and maintenance.
- 2-year warranty on the electronic operating system.
- 2-year warranty on the Crystal window fabric.
- 10-year colourfastness warranty for the powder-coating of the aluminium components.
- 5-year warranty on the gloss of the lacquered profiles.
- 7-year warranty on the Fixscreen® technology: zipper must remain in side channel + optimal connection between zipper and fabric.



* See our warranty terms and conditions.

MAINTENANCE

Easy maintenance

The system requires little maintenance, but we do advise the following to ensure years of sun-protection enjoyment.

- If the fabric gets wet in an unexpected shower, you can roll it up without problems and then roll it out later to allow it to dry. However, we highly recommend rolling up fabrics with integrated Crystal windows when these are completely dry! Do not allow the fabric to stay rolled up wet for more than three days so as to prevent mould and stains.
- Before cleaning, remove loose dirt with a brush or vacuum cleaner. You can then use a cleaning product (avoid corrosive products) and remove the remaining dirt with lukewarm water. Always rinse the fabric after cleaning.
- Do not clean in direct sun: quick-drying soapy water can leave stains on the fabric. Do not use abrasive products to clean.
- Only wash the Crystal window fabric with clean, lukewarm water ($\pm 30^{\circ}\text{C}$).
- Dirty anodised or enamelled profiles can be cleaned using lukewarm water and a gentle cleaning product. Do not use corrosive or harsh products, scourers or other scouring products. We also recommend that you do not use high-pressure equipment.
- The hinges and moving parts should be lubricated at least annually. Use a dry lubrication for this (Veidec Dry Lube [G6002790]). The PVC side guides through which the zippers of the screens run must be lubricated at least once a year (Ceramic Lube [G6002795]).
- As the manufacturer, we recommend that you have the installation technically inspected on a regular basis:
 - Annually for a utilities building and for privately owned sun protection.
 - Every six months in extreme conditions [e.g. in coastal regions].
- Always use original parts for maintenance.
- See our user manual for more information.



FAQ AND TIPS

Column positions - Camargue®, Algarve® and Lapure®

Camargue®, **Algarve®** and **Lapure®** can be ordered with “shifted” columns. This can be useful if, e.g. the terrace covering needs to come out further than the terrace (but the columns still need to be on the terrace) in order to provide enough shade even when the sun is low in the sky.

You can also opt for shifted columns due to placement or architectural reasons. The column can be shifted a maximum of $\frac{1}{5}$ th of the total Pivot length.

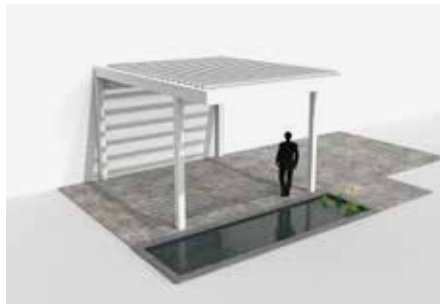
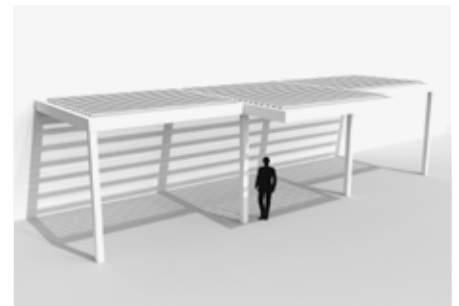
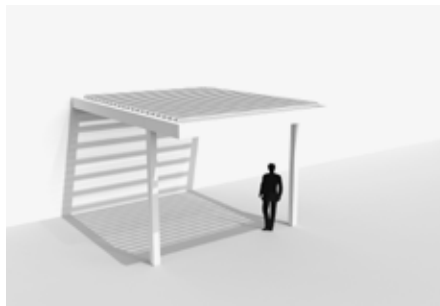

Blade rotation direction - Camargue® and Algarve®

Think about the direction you want your blades to rotate. Do you want to be able to protect against the sun for as long as possible or allow as much light in as possible?

You can make this choice with RENSON®. E.g. when adding on to a kitchen or a living room, people usually want to get as much light in as possible.

① The blades rotate as standard, to the extent that the southern sunlight is blocked when opening the blades. You can also slightly turn the standard sun protection blades in by rotating them more.

② When the blades are slightly turned in, the blades will move into the right angle more quickly and the smooth, lovely underside remains visible.

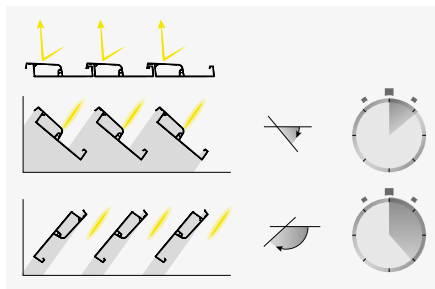

- ① STANDARD SUN PROTECTION:
Slightly held back when opening
[perfect for high usage in the summer]

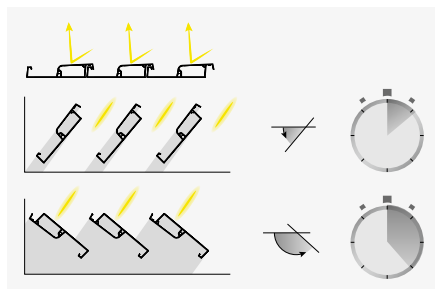

- ② Slightly held back when opening
[perfect for high usage in the winter]

Blade colours - Camargue®, Skye® and Algarve®

Camargue®, Skye® and Algarve® are available in two-toned colours (frame and columns in a different colour than the roof blades) at no extra cost. Tip: select a lighter colour for the blades when the structure is a darker colour. A darker roof blade colour creates the impression of a lower ceiling. A lighter colour creates a sense of more space.



Veranda

Is a terrace covering like **Camargue®** or **Algarve®** similar to a veranda? No! A veranda is an extension of the living space enclosed in glass and creates an enclosed space that is completely wind and waterproof. In contrast, a terrace covering is an open aluminium structure with a roof of rotating, aluminium blades that [possibly combined with side panels] primarily offers shelter from the sun and, to a certain extent, bad weather. It is the outside that permeates the space under a terrace covering so that the users can enjoy the ambiance, scents, colours and sounds of the garden. so it is best to use weather-resistant garden furniture under the **Camargue®** or **Algarve®**.

Wind - Camargue® and Algarve®

If high winds are forecast, we recommend closing the roof panels [this can be done in wind speeds of up to 50 km/h]. The entire structure is more solid and can better withstand the wind when the louvered roof is closed. We also offer a warranty on our **Camargue®** and **Algarve®** with the roof closed for wind speeds of up to 120 km/h!

Screen fabric or blades? - Camargue®, Algarve®, Lapure® and Lagune®

How can I choose between a terrace covering with a louvered roof [**Camargue®** and **Algarve®**] or with a screen fabric roof [**Lapure®** and **Lagune®**]? Each type of terrace covering has its own advantages. A covering using a sun protection screen can be opened up completely. This way you can keep out the sunlight or let it in completely depending on the weather. Terrace coverings with louvered roofs allow the user to control the amount of sunlight based on what is desired; when there is too much sunlight, the blades can be closed completely, but the roof can never be opened up completely to let in all of the sunlight.



	Louvered roof	Screen roof
Roof	Horizontal	Always at an angle
Position	Constructed, recessed or free-standing	Only constructed
View of "open" roof	Roof blades rotate to open but don't "disappear"	"Roof" completely disappears
Light in a "closed" roof	Opaque [except Lineo Luce blades]	Transparent
Load-bearing capacity	Can bear snow	Cannot bear snow
Colour of the roof	All possible colours	Limited range of colours available for fabric screen roof

Low sun: Fixscreen® - Camargue® and Lagune®

When the sun is low in the sky, sunlight can come in underneath the terrace covering and into your home. This is perfect for naturally warming your house up in the winter. However, this sunlight can be disruptive at times and cause temporary blindness, colours to fade, or reflections on the TV and computer screens. Thanks to the vertical sun protection fabric [Fixscreen®] in the sides of your terrace covering, the incoming sunlight is reduced. At the same time, contact with the outside is maintained because the fabric is transparent.



Passage height - Camargue® and Algarve®

The passage height for a louvered roof is optional. People will usually choose a height for a specific situation [e.g. if there is a gutter or window in the way in a construction situation, etc.] or for personal reasons. A tall person prefers a higher passage height to have a certain amount of "openness". On the other hand, it is best to have the lowest possible passage height for the most shade.



Terrace orientation - Camargue® and Algarve®

Depending on the orientation of the terrace, you can position the covering differently. A terrace covering with screen fabric or adjustable blades are both good solutions for a terrace facing southwards.

You can keep the heat of the sun at bay by rolling out the fabric or closing the blades. It is best to install the blades of a louvered roof parallel to the home. This way you can best control the amount of sunlight that gets in: entirely or partially kept out or allowed to come in.

It is a good idea to install the blades perpendicular to the wall for a terrace that faces northwards. This is the best way to control the light coming in from the east and west, while the most light can be achieved when open.

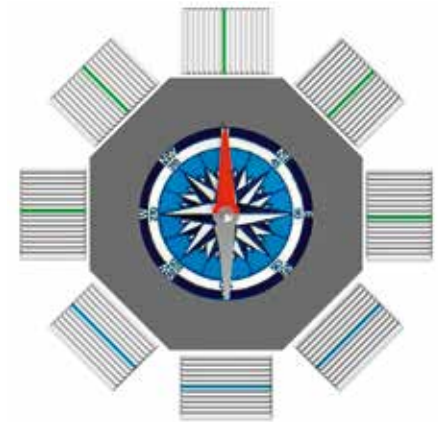

- O-NO-N-NW-W: blades transverse to the wall.
- ZW-Z-ZO: blades parallel with the wall.

WHERE CAN YOU AS A CUSTOMER PURCHASE RENSON® PRODUCTS?

To ensure high-quality expertise and professional installation of RENSON® products, we have set up a network of well-trained Ambassadors and Installers.

RENSON® Ambassadors display our products in their showrooms and ensure that the product you have purchased is professionally and properly installed by their own installation team.

In addition, they also guarantee professional after-sales service.

RENSON® Official Dealers display our products in their showrooms and offer you professional advice.

RENSON® Official Installers ensure that the product you have purchased is professionally and properly installed by their own installation team.

In addition, they also guarantee professional after-sales service.

What are the benefits of working with a RENSON® Ambassador, Official Installer, and Official Dealer?

- He/she is perfectly trained and has the required expertise with regard to our products
- He/she provides you with tailor-made professional advice
- He/she can prepare a correct offer
- He/she guarantees perfect after-sales services and is always available to assist you

You will recognise our RENSON® Ambassadors, Official Dealers and Official Installers through the official labels shown at the right.

See also www.renson-outdoor.be



RENSON®: YOUR PARTNER IN VENTILATION AND SUN PROTECTION

Renson®, headquartered in Waregem (Belgium), is a trendsetter in Europe in natural ventilation and sun protection.

• Creating healthy spaces

From 1909, we've been developing energy efficient solutions assuring a healthy and comfortable indoor climate. Our remarkable headquarters – built according to the 'Healthy Building Concept' – is a beautiful example portraying our corporate mission.

• No speed limit on innovation

A multidisciplinary team of more than 70 R&D employees continually optimize our products and develop new and innovative concepts.

• Strong in communication

Contact with the customer is of the utmost importance. A group of 70 in-the-field employees worldwide and a powerful international distribution network are ready to advise you on site. EXIT 5 at Waregem gives you the possibility to experience our products

on your own and provides necessary training for installers.

• A reliable partner in business

We can guarantee our customers optimal quality and service thanks to our environmentally friendly and modern production sites [with automated powder coating line, anodisation line, uPVC injection molding machinery and mold making shop] covering an area of 95.000 m².





EXIT5

Renson's headquarters, designed by the famous Belgian architect Jo Crepain, is extended with an impressive showroom called "Exit 5". The name of this extension was named after the exit number 5 on the E17 motorway.

Our headquarter is fully compliant with our Healthy Building Concept and is the company's calling card for years. Now you can visit our "Customer Centre" Exit 5 on the ground floor of the building behind an impressive glass façade. Exit 5 is created to host several events: hospitality rooms for customers, different meeting rooms and a multi-functional auditorium that can host more than 250 people.

Our real eye-catcher is the 1.250m² showroom where professional prospects as well as private customers are welcome. There, you can experience all the Renson innovative solutions and concepts. More and above this space is the centre of expertise where you can find all your answers on ventilation, sun protection, ventilative cooling and acoustics.

BUILDING OR RENOVATION PLANS?
VISIT OUR SHOWROOM

WWW.EXIT5.BE
ALSO OPEN ON SATURDAYS!

EXIT 5 IS OPEN

Monday to Friday: 8 a.m. - 6 p.m.

Saturday: 9 a.m. - 12 noon

Or make an appointment on 056 62 96 87

Maalbeekstraat 10 • 8790 Waregem • Belgium



BUILDING PLANS? VISIT OUR SHOWROOM

WWW.EXIT5.BE
MAALBEEKSTRAAT 10 • 8790 WAREGEM



App available on:



Download it from
GOOGLE PLAY



Download it from
APP STORE



Download it from
WINDOWS PHONE

My Outdoor

Take a picture of your terrace or house, select a terrace covering and adapt it to suit you. As soon as you are satisfied with your creation, you can share it with family or friend or send it to a distributor near you to get a price quoted.

Your distributor:



Creating healthy spaces

RENSON® Headquarters
Maalbeekstraat 10, IZ 2 Vijverdam
B-8790 Waregem, Belgium
Tel. +32 (0)56 62 71 11
Fax +32 (0)56 60 28 51
export@renson.net
www.renson-outdoor.com



* L 2 0 0 9 0 5 *

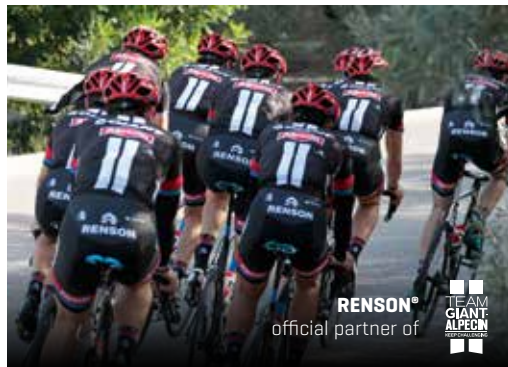
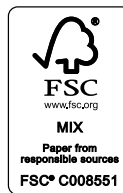

L200905 09/16 English