



 **FORGE/os 5**
Kawasaki EOx Start Up Guide



The documentation, best practices, and recommendations provided by READY Robotics do NOT constitute safety advice. Products sold through READY Robotics are not by themselves a fully integrated workcell. As required in ISO 10218-2, READY Robotics strongly recommends performing a complete risk assessment of the integrated workcell per ISO 12100. You may wish to use the methodology found in the ANSI/RIA TR R15.306 Task-based Risk Assessment Methodology.

CONTENTS

- Overview 4
- Hardware Requirements 5
- Software Requirements 8
- Installing the Safety Controller 11
- Connecting the READY pendant 12
- Connecting the Robot to Forge/OS 19
- Programming the Safety Controller 20
- Setting Up the Robot Controller 24
- Signing In to Forge/OS 32
- Getting the Cubic-S File from Forge/OS 34
- Transferring Cubic-S Parameters 37
- Adding the Robot in Device Configuration 40
- Appendix A: Setting Up Forge/OS 43
 - Installing Forge/OS 43
 - Activating Forge/OS with a License Code 52
 - Choosing Preferences 55
- Appendix B: Tool Loading Steps 56
- Resources 61

OVERVIEW

Welcome to the Kawasaki E0x controller start up guide. Use this guide to set up your robot and Forge/OS 5.

Here is an outline of the steps you will follow:

1. Set up safety I/O hardware.
2. Connect the READY pendant.
3. Connect the IPC that will run Forge/OS.
4. Power on your systems.
5. Change robot settings.
6. Add the robot in Forge/OS!

Note: This guide assumes you have installed the robot and controller according to Kawasaki instructions. If the Cubic-S unit wasn't installed by Kawasaki, contact Kawasaki Robotics. We recommend backing up your robot controller before starting.

REFERENCES

Reference	Description, Link
[1]	KEYENCE GC-1000 reference design and instructions, Link

HARDWARE REQUIREMENTS

Image	Part Name	Description	Vendor	Part Number
	READY IPC	<p>Hosts Forge/OS.</p> <p>Note: READY offers two IPCs: Forge/Hub and Forge/Ctrl (legacy)</p>	READY Robotics	
	READY pendant	The touch screen interface for Forge/OS.	READY Robotics	112563
	READY pendant Junction Box (Forge/Ctrl only)	Connects the READY pendant to the Forge/Ctrl and robot controller.	READY Robotics	R-101257
	12-Pin M12 to Flying Leads Cable	Connects to the READY pendant Junction Box or Forge/Hub to terminals.	READY Robotics	
	E0x Robot Controller	Connects the robot arm to power and to other devices.	Kawasaki	
	Compact Flash Card for OpenAS	Required for "Robot Network Extension" option to use Forge/OS.	Kawasaki	60851-0016

Image	Part Name	Description	Vendor	Part Number
	Cubic-S Robot Safety Monitoring Kit (without Ethernet/IP)	Required for safe speed/area monitoring and tool selection from Forge/OS.	Kawasaki	40217-G098
	CN2 Outputs Cable & Interface Modules	Connects 24V outputs from the robot controller.	Kawasaki	
	CN4 Inputs Cable & Interface Modules	Connects 24V inputs to the robot controller.	Kawasaki	
	Large Polycarbonate Enclosure or Electrical Cabinet	Protects the electrical parts in an enclosure.		
	USB A-Male to B-Male Cable	Connects a Windows PC to the Cubic-S unit to change safety settings.		
	Cat5e STP Shielded Ethernet Cable (x2)	<ul style="list-style-type: none"> ▪ Connects the robot controller to an IPC. ▪ Connects the READY pendant to an IPC. 		
	24V/2.5A Power Supply	Powers the safety controller and more. Min./Max. current: 2.5/5.0 Amps.		e.g., Siemens 6EP1332-5BA00

Image	Part Name	Description	Vendor	Part Number
	Compatible Safety PLC (see note below)*	Required for pendant safety features and other safeguard devices (i.e. safety fence).		e.g., SICK FLX3-CPUC200, Banner XS26-2, KEYENCE GC-1000

Note: The safety PLC you choose should meet these minimum requirements:

- 4x dual channel safety inputs
- 3x PNP safety outputs (or use safety relays)
- 2x PNP general purpose outputs
- Basic Safety Logic configuration

SOFTWARE REQUIREMENTS

This section explains how to check your Kawasaki software version and install needed programs on a Windows PC.

Software	Minimum Version	Description
E0x Controller Software	ASE801010XX3S	Software version installed on the robot controller.
Robot Network Extension Option (Enabled)	2.2.1	Kawasaki option needed for Forge/OS to work with the robot controller.
CS-Configurator, Kawasaki	04.01.00	Windows software for programming the Kawasaki Cubic-S unit.
Forge/OS Perpetual License	5.1.0	Single, perpetual license to Forge/OS.

1 Check the software version on your Kawasaki controller:

a Press the **MENU** button on the pendant keypad.

b Select the **Aux Function** option. Tap the option on the screen or highlight it with the keypad arrows and press **ENTER**.

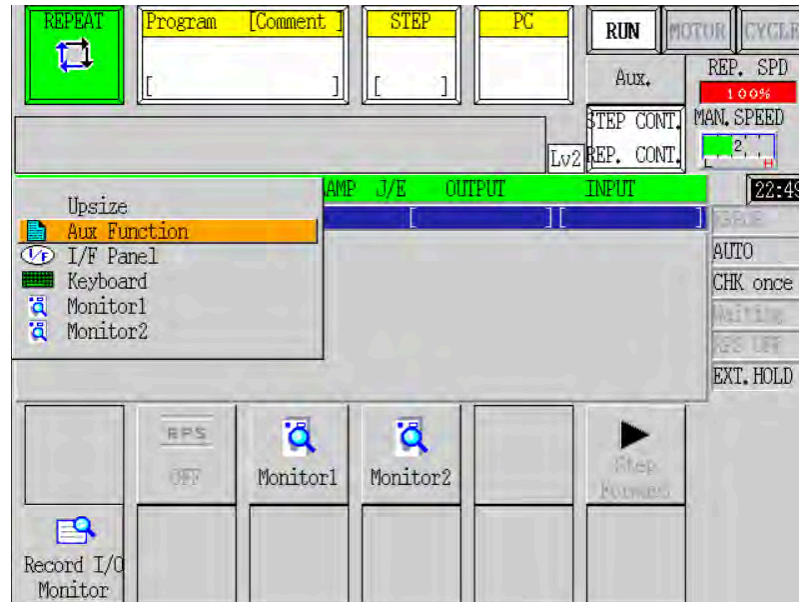

c In the Aux. menu, select **System**.

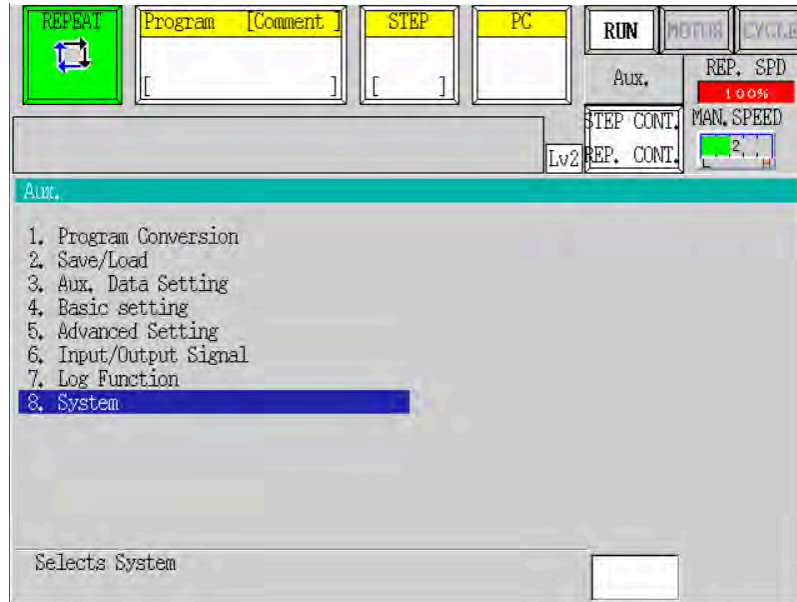

d In the System menu, select **Software Version**.

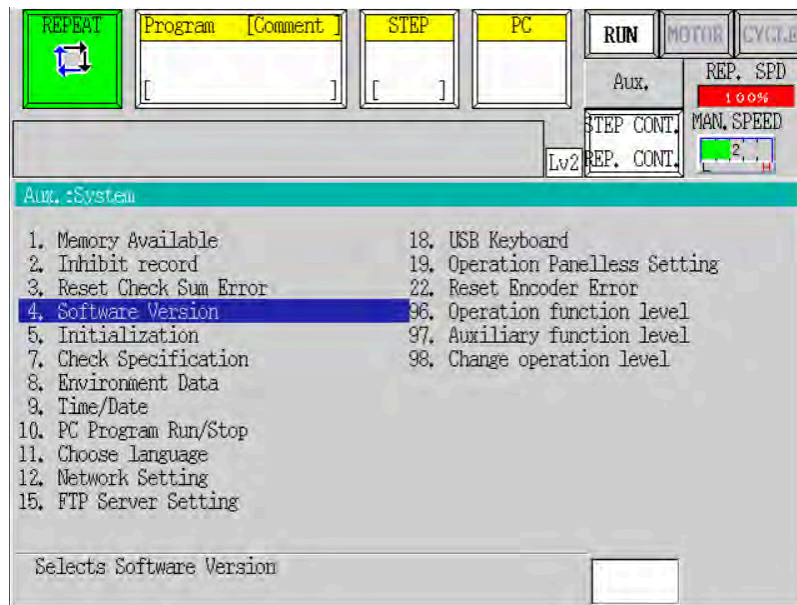

e On the Software Version screen, look for "AS GROUP." Check your AS version number.

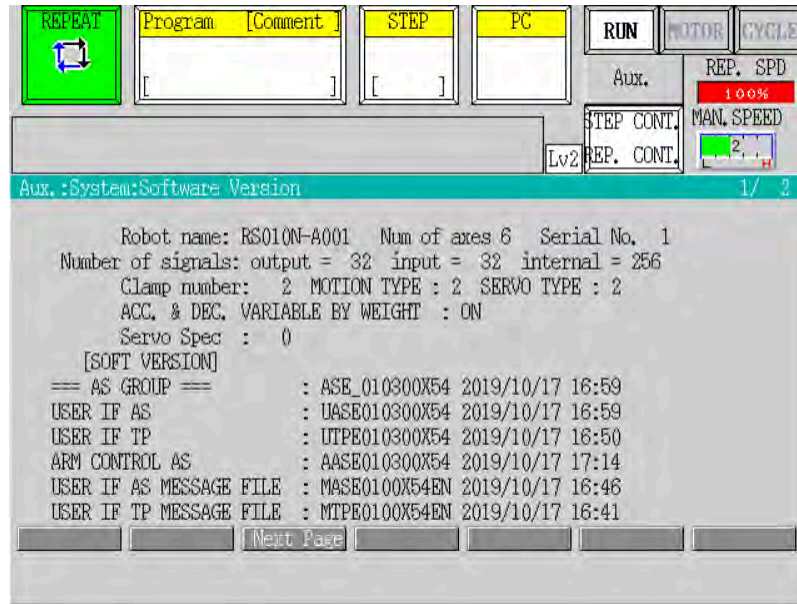

f Contact Kawasaki if you need to update your software version to the minimum version.

2 Install CS-Configurator on a Windows PC:

a Go to the [Kawasaki Robotics Download Center](#).

b Apply for free to become a member and wait for an approval email, up to 2 business days.

c Sign in to the Download Center.

d Search for "CS-Configurator".

e Download and install the software.

3 Install the USB driver that comes with the CS-Configurator:

a Search Kawasaki's Download Center for "... Controller, Cubic-S Instruction Manual".

b Download the Cubic-S Instruction Manual, then follow section 8.2.1 for Installing the USB Communication Driver.

INSTALLING THE SAFETY CONTROLLER

In these steps, you install your safety controller, a power supply, and terminal blocks for connecting safety input leads.



1 In an enclosure (i.e., safety cabinet), install these:

- DIN rail (as needed)
- The safety controller
- The 24V power supply
- Terminal blocks (as needed)
- DIN rail ends (to prevent terminal blocks from moving)

Note: See each product's manufacturer guides for installation instructions.

2 Install cord grips through the enclosure walls as needed to provide strain relief for I/O and power cables.

3 Connect the 24V power supply output to your safety controller power supply inputs.

4 Connect the 24V power supply to external power following power supply instructions.

Note: Confirm everything powers up, then disconnect the power supply from external power before moving on.

CONNECTING THE READY PENDANT

In this section, you connect the READY pendant safety features to the robot through the safety controller. The READY pendant includes these safety outputs:

1. Key Switch (Robot Operation Mode)
2. Three-Position Enabling Switch
3. Emergency Stop Button



Tip: While following the steps in this section, refer to the given wiring diagrams and tables:

- For selected safety PLCs, see the wiring diagrams included in the [References](#).
- For other safety PLCs, refer to the wiring diagram on the next page.



Electric Shock Warning: Disconnect all components from power sources before attempting this installation.

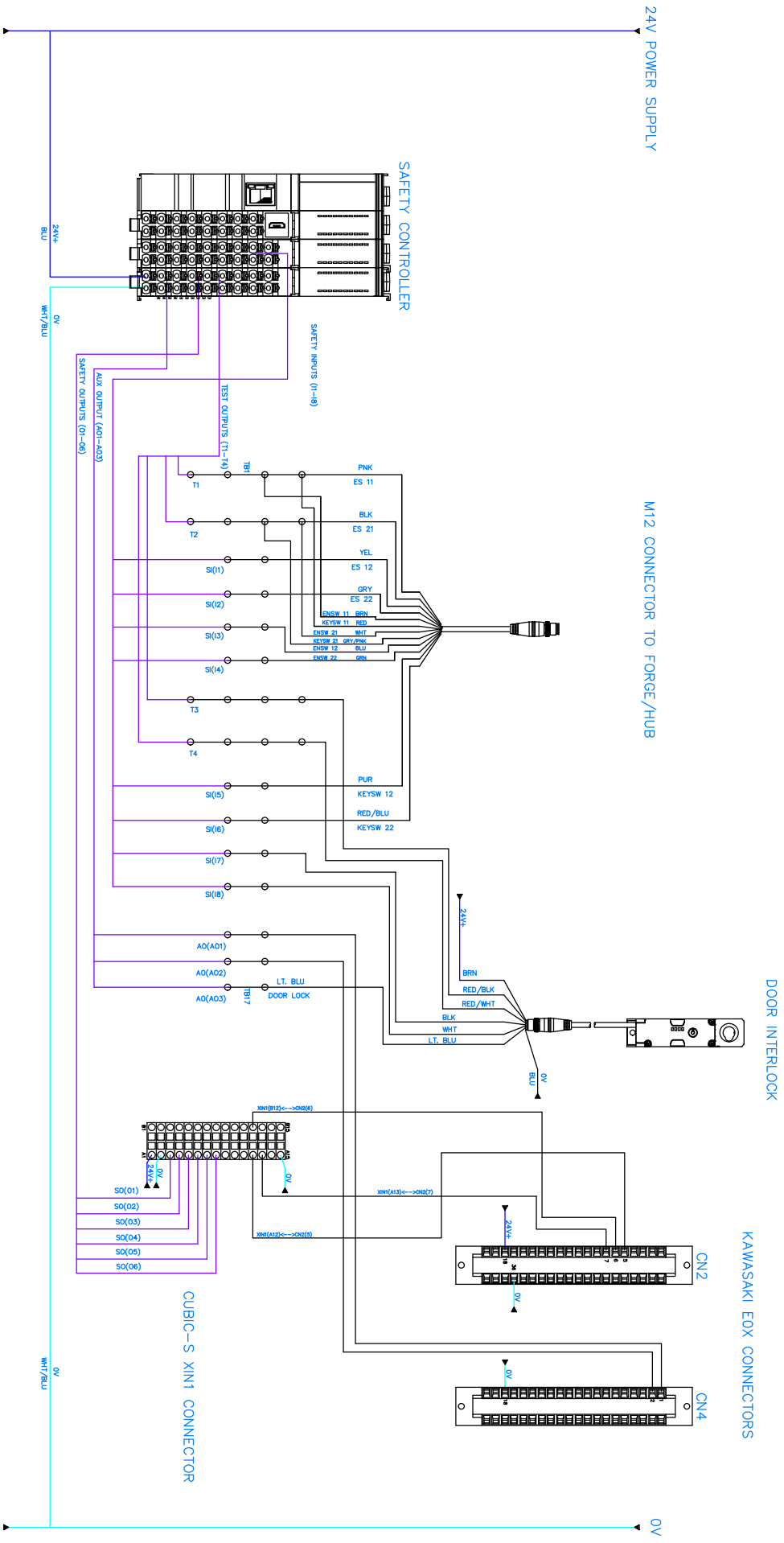

Safety Controller to Kawasaki EOX Wiring Example

RE:ADY Robotics
1080 Steeplewood Rd.
Columbus, OH 43212

REV: ES-700022-3 RA

SCALE: N/A

SHEET: 1 OF 1

ISSUED: DRAWN: J. Miller

DO NOT SCALE DRAWING

DWG. NO. ES-700022-3 RA

1 If you are using a Forge/Ctrl, prepare the READY pendant Junction Box:



- a Connect a Cat5e STP Ethernet cable from the junction box Ethernet port (1) into a **LAN** port (5) on the Forge/Ctrl.

- b Connect the 8-Pin power cable (4) from the junction box into one of the **Module** ports (6) on the Forge/Ctrl.

- c Connect the 12-Pin flying leads cable to the safety port (3) on the junction box.

2 If you are using a Forge/Hub, connect the 12-Pin flying leads cable to the **Safety** port on the Forge/Hub.



- 3 The flying leads go to your safety controller. For selected safety PLCs, see the wiring diagrams included in the [References](#) before moving on.

- 4 Connect the flying leads to the safety controller according to the table below.

Important: Refer to safety controller documentation for proper use of safety test outputs. You can share a test output among different devices, but each channel of a device should use a different test output.

Safety Flying Leads	Function	Destination
Brown	Enabling Switch Circuit 1	Test Output 1
Blue	Enabling Switch Circuit 1	Safety Input 3
White	Enabling Switch Circuit 2	Test Output 2
Green	Enabling Switch Circuit 2	Safety Input 4
Pink	Emergency Stop Circuit 1	Test Output 1
Yellow	Emergency Stop Circuit 1	Safety Input 1
Black	Emergency Stop Circuit 2	Test Output 2
Grey	Emergency Stop Circuit 2	Safety Input 2
Red	Key Switch Circuit 1	Test Output 1
Violet	Key Switch Circuit 1	Safety Input 5
Grey/Pink	Key Switch Circuit 2	Test Output 2
Red/Blue	Key Switch Circuit 2	Safety Input 6

5

Wire the external safety fencing or other safeguard device to the safety controller:

Function	Destination
Fence Contact 11 (Circuit 1)	Test Output 3
Fence Contact 12 (Circuit 1)	Safety Input 7
Fence Contact 21 (Circuit 2)	Test Output 4
Fence Contact 22 (Circuit 2)	Safety Input 8

6 Follow the substeps below to connect the safety controller to the Kawasaki destinations in this table:

Function	24V Power Supply	Cubic-S	E0x (1TW Board)	Safety Controller
External Power	24V	XIN1(A1)		
	0V	XIN1(A2)		
External Power	24V	XOUT1(A1)		
	0V	XOUT1(A2)		
Pendant Emergency Stop		XIN1(A3)		Safety Output 1
		XIN1(A4)		Safety Output 2
Robot Speed Monitoring		XIN1(A5)		Safety Output 3
		XIN1(A6)		Safety Output 4
Pendant Enable Switch		XIN1(A7)		Safety Output 5
		XIN1(A8)		Safety Output 6
External Power	0V		CN4(18)	
Robot Speed Monitoring			CN4(1)	Auxiliary Output 1
Pendant Enable Switch			CN4(2)	Auxiliary Output 2
External Power	0V	XIN1(A15)		
	0V		CN2(36)	
	24V		CN2(18)	
Tool Selection		XIN1(A12)	CN2(5)	
		XIN1(B12)	CN2(6)	
		XIN1(A13)	CN2(7)	

a Unscrew and remove the top of the E0x controller to access the Cubic-S unit inside.

- b** Make your own cabling for the 12 wires that go from the safety enclosure to the XIN1 terminals on the Cubic-S unit. Add ferrule ends to your wires to insert in terminal blocks.

- c** Make cabling for the four wires that go from the XIN1 terminals on the Cubic-S unit to the Input/Output interface module. Add ferrule ends to your wires to insert in terminal blocks.

- d** Find your general purpose I/O cables that you'll connect from the Input/Output interface modules to CN2 and CN4 on the 1TW board inside the robot controller.

- e** In the I/O inlet plate on the back of the controller, make at least one hole large enough to fit your general purpose I/O cables and the Cubic-S safety wiring from the safety enclosure. Route your wiring through the hole using a cord grip.

- f** Connect the safety controller output wires to the Cubic-S terminals in the destination table above.



- g** Connect the Input/Output cables to ports CN2 and CN4 on the 1TW board. Connect the wires on the other end to the destinations in the table above.

- 7** Double-check your wiring by referring to the tables above. Fix any mistakes you find.

- 8** Put the top plate of the robot controller back on and screw it in place.

CONNECTING THE ROBOT TO FORGE/OS

Forge/OS must communicate with the robot controller. This section helps you connect the IPC device and robot controller using an Ethernet cable.

- 1 Find a Ethernet cable (Cat5e STP) long enough to reach from the IPC to the robot controller.

- 2 Plug one end of the Ethernet cable into a LAN port on the IPC. Plug the other end into **Ethernet Port 1** in the front accessory panel of the E0x controller.

- 3 Power on your robot controller and IPC:
 - a Connect the robot controller to power and power it on. Follow Kawasaki instructions for powering the controller.

 - b Connect your IPC to a power source and power it on.

Note: If you are using a Forge/Ctrl, turn the Power Disconnect Switch to **ON**. Then press the green power button on the opposite side.

 - c Connect your safety enclosure to a power source and power it on.

 - d If there are issues, power off each device, disconnect from power supplies, and check your wiring.

PROGRAMMING THE SAFETY CONTROLLER

In this section, you program the safety controller (PLC) for the devices in your setup. Refer to safety controller documentation to install software, connect to the safety controller, and program it.

Tip: For selected safety PLCs, refer to the included program files and instructions in the [References](#).

The safety logic you need follows after this example (made in SICK Safety Designer):

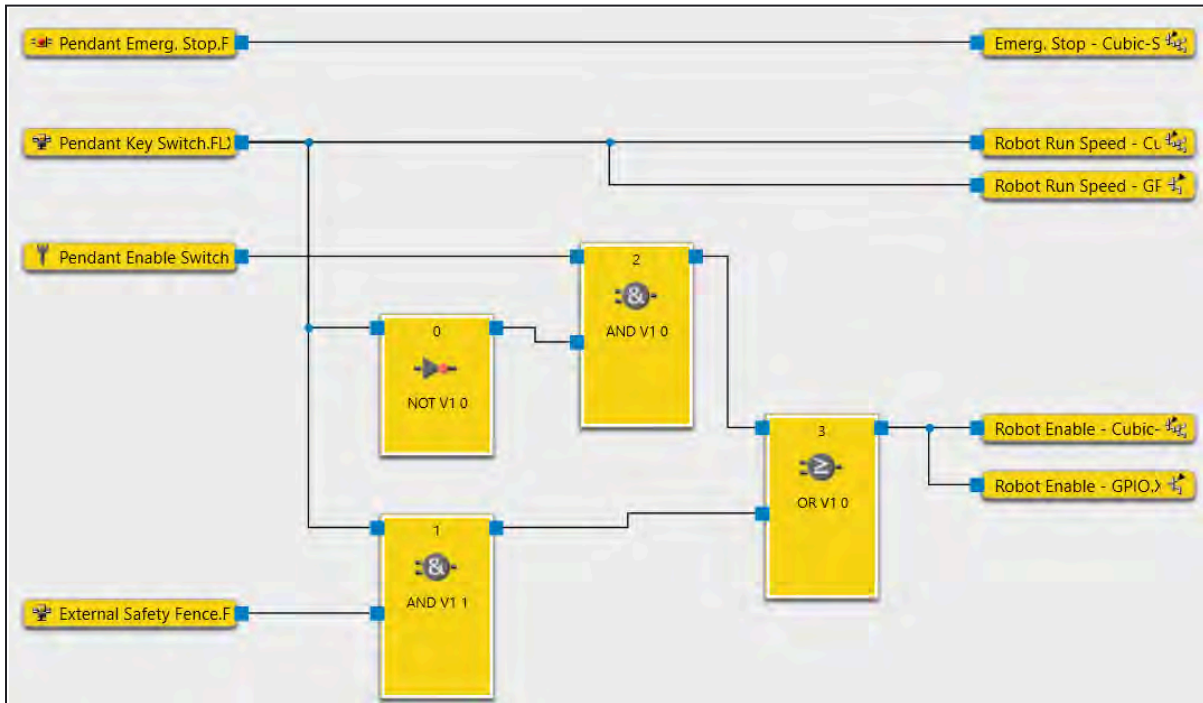

- 1 On a PC, install the safety PLC's configuration software. Refer to manufacturer instructions.
- 2 Connect your PC to the safety PLC following manufacturer instructions. Usually, you connect the PC through a USB or Ethernet cable.
- 3 Open the configuration software on your PC. Select your safety PLC model and add-on modules as needed.
- 4 Add the READY pendant and safeguard inputs in the software and give them descriptive names. Set them to the safety input terminals you wired earlier.

- 5 Add the PNP output signals. Set them to the safety output and auxiliary output terminals you wired earlier. The table below shows where each output goes and what it does.

Safety PLC Outputs	Kawasaki Destination	Function
Safety Outputs 1-2 (dual-channel)	Cubic-S Input 1	Emergency Stop to Cubic-S (HIGH=motion allowed)
Safety Outputs 3-4	Cubic-S Input 2	Mode Switch to Cubic-S (HIGH=run speed allowed, LOW=teach speed limit)
Safety Outputs 5-6	Cubic-S Input 3	Enable Switch to Cubic-S (HIGH=motion allowed in teach mode)
Auxiliary Output 1	GPIO Input 1 (I1)	Mode Switch to robot (HIGH=run speed allowed, LOW=teach speed limit)
Auxiliary Output 2	GPIO Input 2 (I2)	Enable Switch to robot (HIGH=motion allowed in teach mode)

- 6 Follow these substeps to program the safety logic in the PLC logic editor. Example images were taken in SICK Safety Designer.

Tip: Refer to the [References](#) for more examples from other PLC brands.

- a In the logic editor or other programming window, add the input and output signals you configured. Usually, you can drag and drop them into the logic editor.

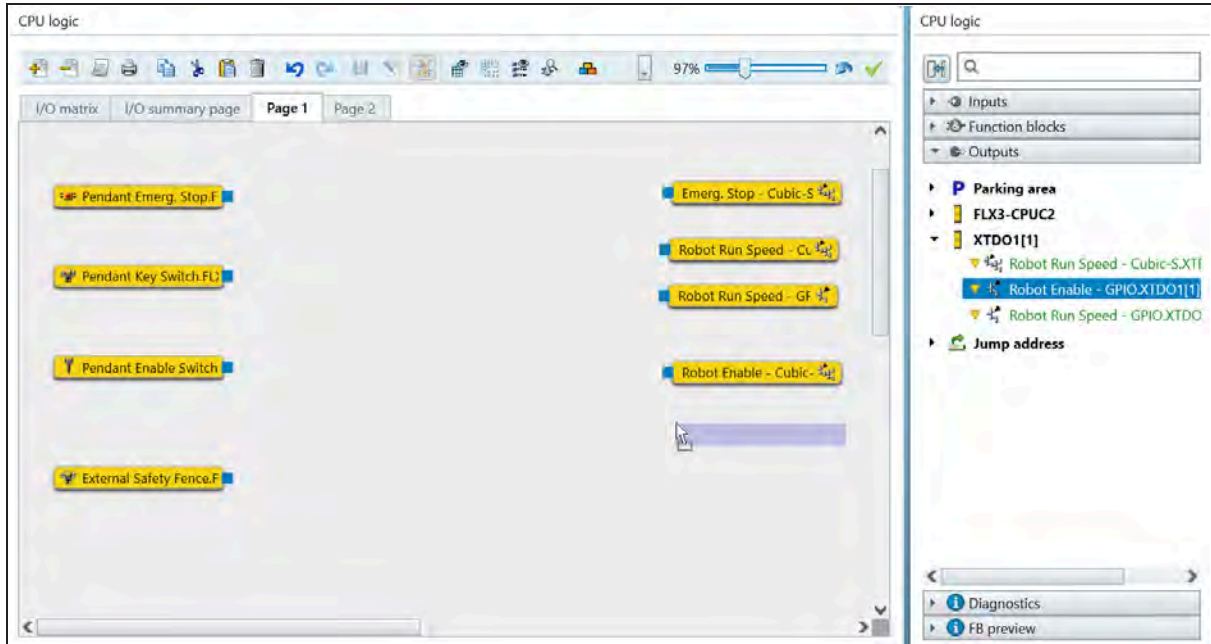

- b Add logic function blocks and connect the blocks to get the required safety logic.

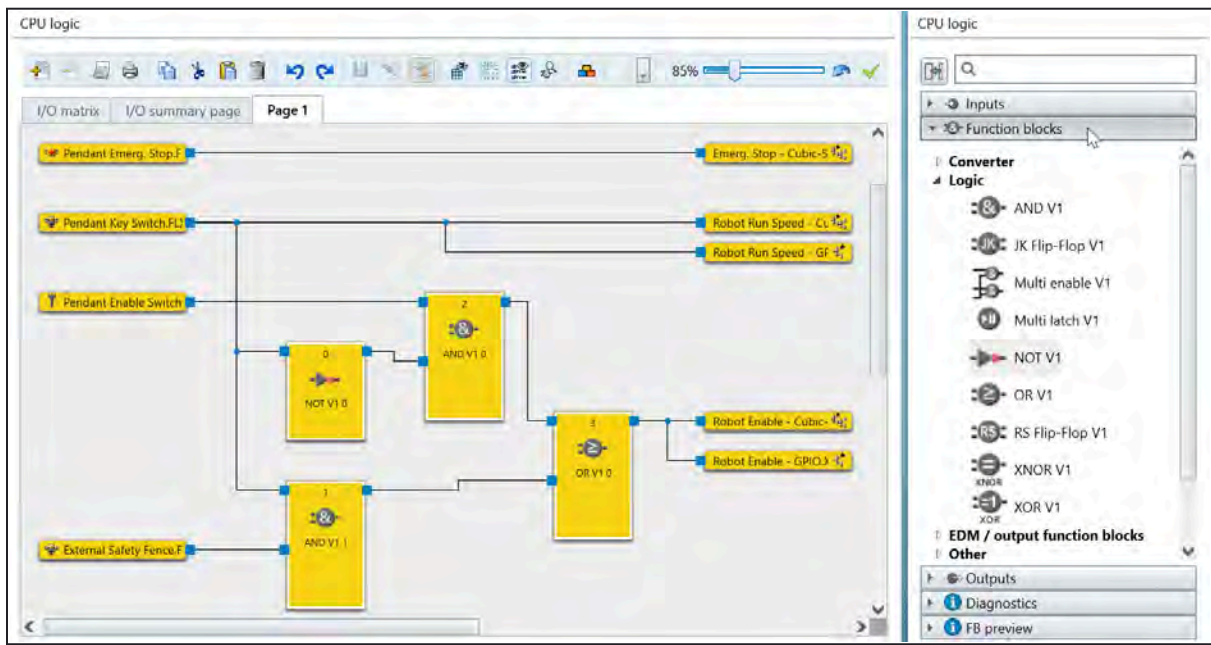

- 7 Save the configuration file on your PC for safe keeping.
.....
- 8 In the configuration software, login or connect to the safety controller and transfer your configuration onto it.
.....
- 9 If applicable, set the safety controller to "Run" or "Auto" mode.
.....
- 10 Disconnect your PC from the safety controller.
.....

SETTING UP THE ROBOT CONTROLLER

In this section, you set up the robot controller to prepare it for Forge/OS.

1 On the Kawasaki controller, Forge/OS uses digital outputs O5, O6, and O7 for tool setting on the Cubic-S unit. Follow these substeps to make sure those digital outputs are available:

a Press the **MENU** button on the Kawasaki pendant keypad.

b Select the **Monitor1** option. Tap the option on the screen or highlight it with the keypad arrows and press **ENTER**.

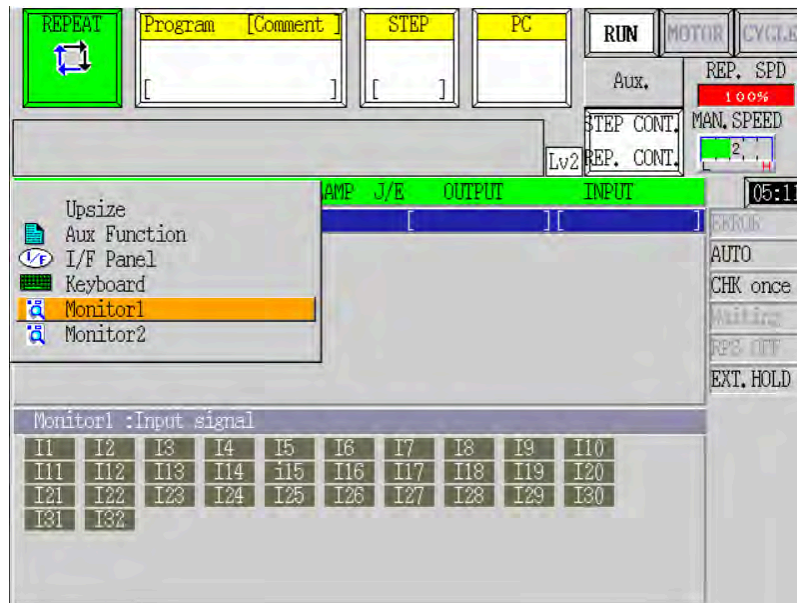

c In the **Monitor1** menu, select **Output signal**. The output signal monitor appears and shows the state of digital outputs.

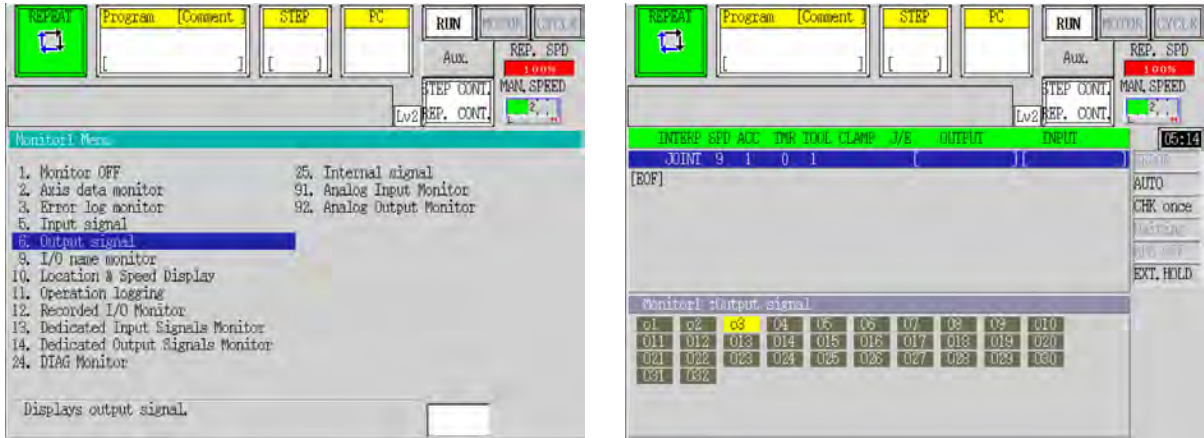

d Check if output signals 5-7 are dedicated. Dedicated outputs start with a lowercase "o" (i.e., o1) and non-dedicated signals start with an uppercase "O" (i.e., O5).

- If signals 5-7 are dedicated (i.e., o5, o6, o7), follow the rest of these substeps.
- If signals 5-7 are available (i.e., O5, O6, O7), move on to [step 2](#).

e To free up dedicated signals, first press the **MENU** button on the pendant.

f Select the **Aux Function** option. Tap the option on the screen or highlight it with the keypad arrows and press **ENTER**.

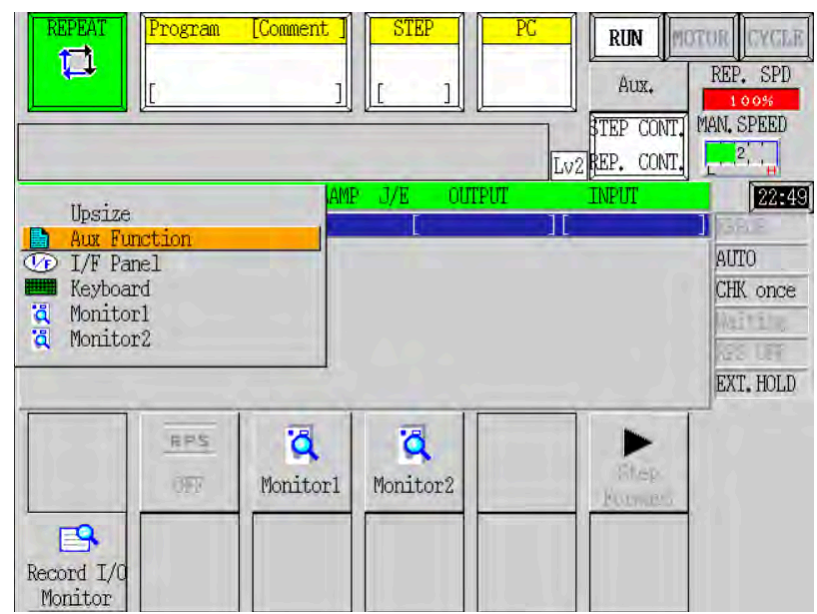

g In the Aux. menu, select **Input/Output Signal**.

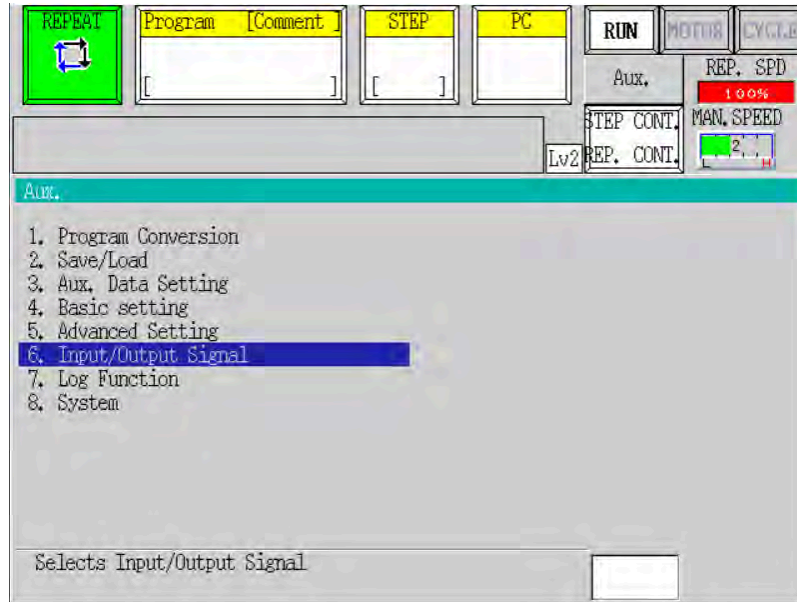

h In the Input/Output Signal menu, select **Dedicated Output Signals**. The output signal options appear. Look for the signal numbers 5-7.



i For each signal using output 5, 6, or 7, change the signal number to another number. In the example below, the signals were reassigned to 13-15.

2 Forge/OS uses inputs I1 and I2 for safety signals. Follow these substeps to make sure those digital inputs are available:

a Press the **MENU** button on the Kawasaki pendant keypad.

- b** Select the **Monitor1** option. Tap the option on the screen or highlight it with the keypad arrows and press **ENTER**.

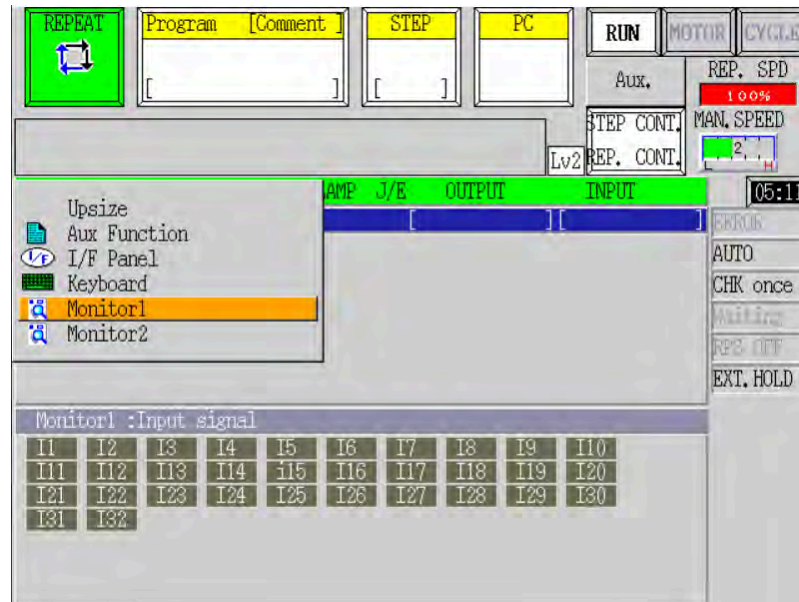

- c** In the **Monitor1** menu, select **Input signal**. The input signal monitor appears and shows the state of digital inputs.
- d** Check if input signals 1-2 are dedicated. Dedicated inputs start with a lowercase "i" (i.e., i2) and non-dedicated inputs start with an uppercase "I" (i.e., I2).
- If signals 1-2 are dedicated (i.e., i1, i2), follow the rest of these substeps.
 - If signals 1-2 are available (i.e., I1, I2), move on to [step 3](#).
- e** To free up dedicated signals, first press the **MENU** button on the pendant.

- f Select the **Aux Function** option. Tap the option on the screen or highlight it with the keypad arrows and press **ENTER**.

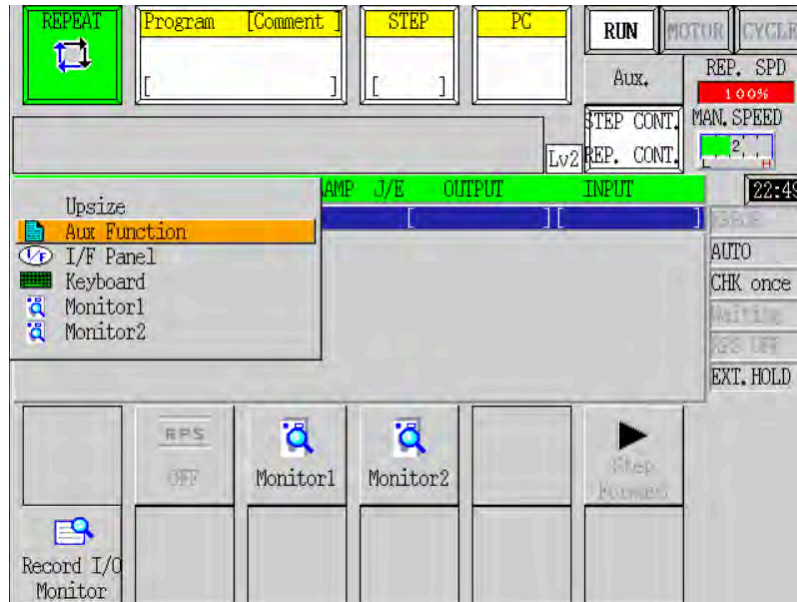

- g In the Aux. menu, select **Input/Output Signal**.

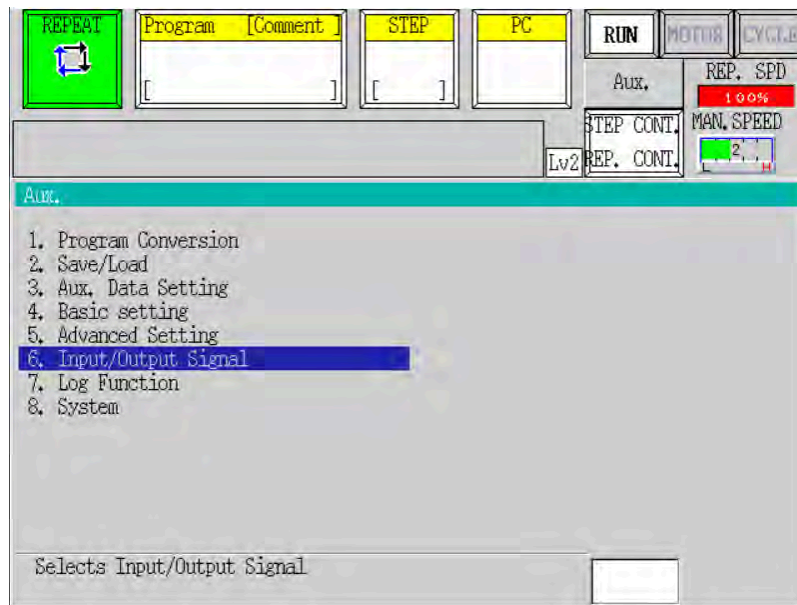

- h In the Input/Output Signal menu, select **Dedicated Input Signals**. The input signal options appear. Look for the signal numbers 1-2.

- i For each signal using input 1 or 2, change the signal number to another number.

3 Follow these steps to change the Kawasaki network settings:

a Press the **MENU** button on the pendant keypad.

b Select the **Aux Function** option. Tap the option on the screen or highlight it with the keypad arrows and press **ENTER**.

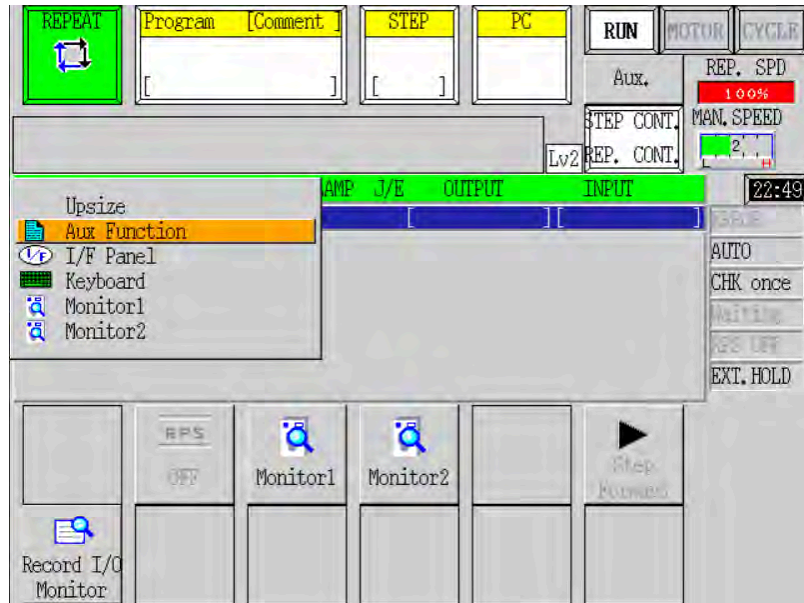

c In the Aux. menu, select **System**.

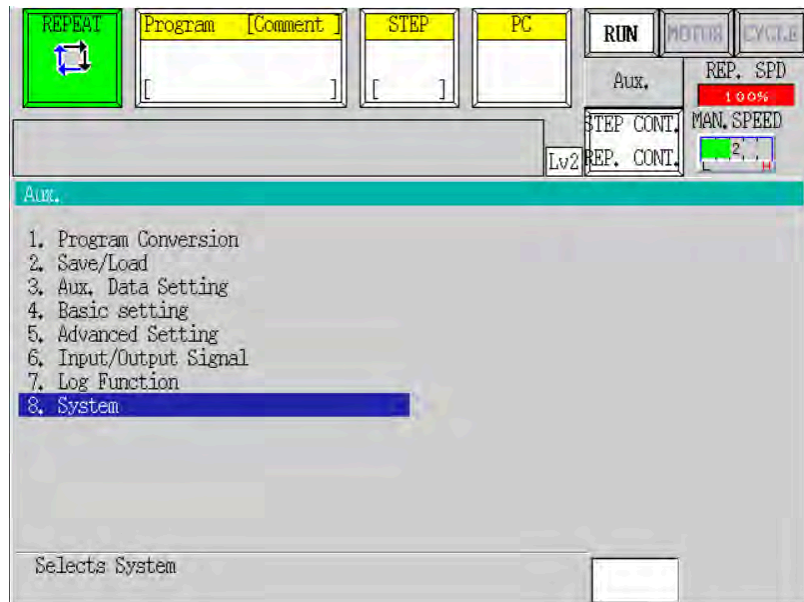

d In the System menu, select **Network Setting**.

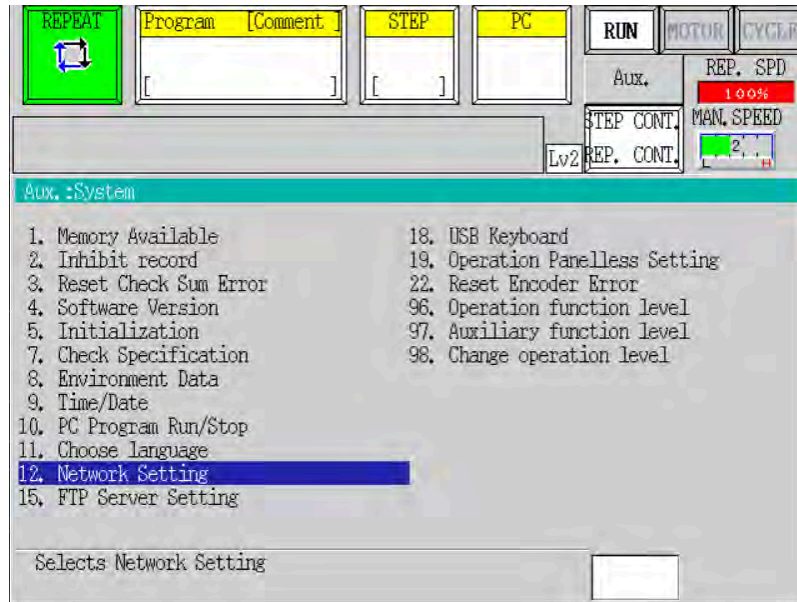

e In the Network Setting options, select **Ethernet Port Setting**.

f Make sure you see "Port 1" at the top of the window. To change the port you're viewing, use the **Next Page** and **Prev. Page** buttons at the bottom. To enter numbers, tap on a white box and press the keypad buttons.

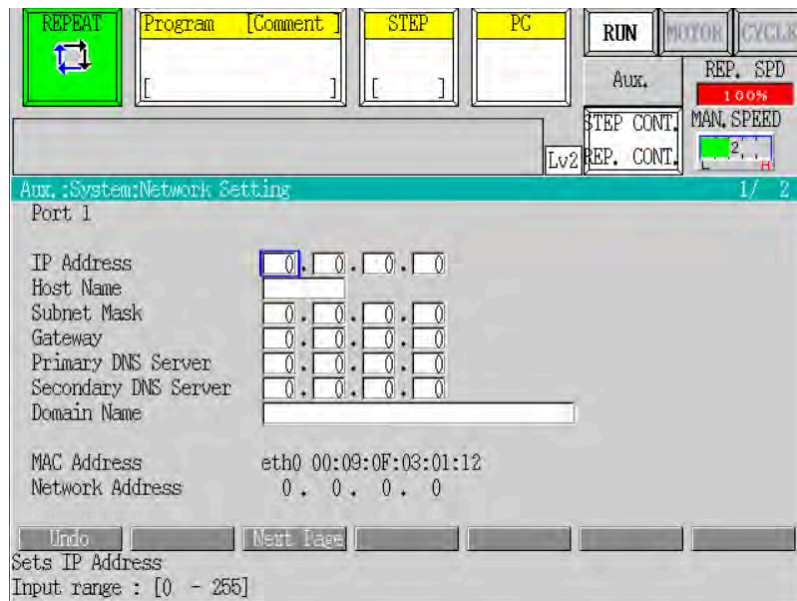

g Set the IP Address and Subnet Mask according to the READY IPC you have:

- *Forge/Ctrl*: set the **IP Address** to **172.16.255.251** and set the **Subnet Mask** to **255.255.255.0**.
- *Forge/Hub*: set the **IP Address** to **192.168.1.20** and set the **Subnet Mask** to **255.255.255.0**.

h Press the **ENTER** button on the Kawasaki pendant.

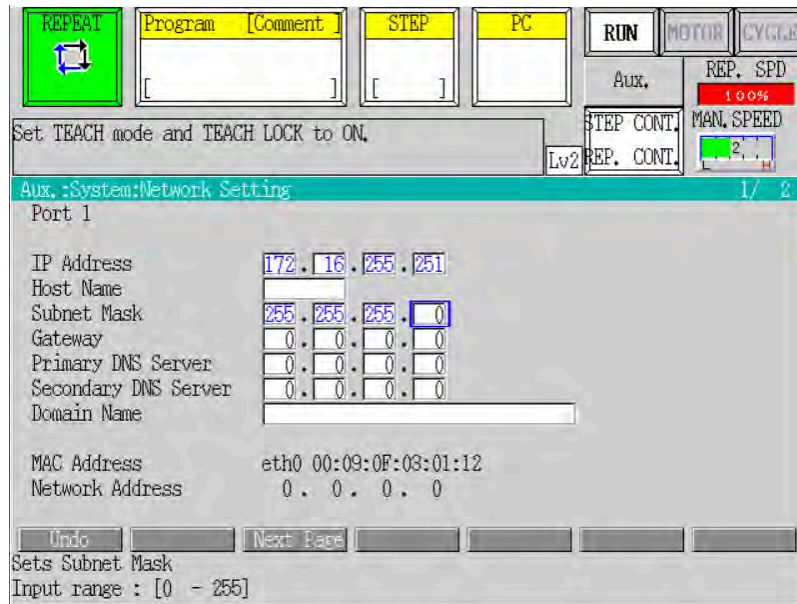

i Tap **Yes** to confirm the settings. Then set the Kawasaki pendant aside.

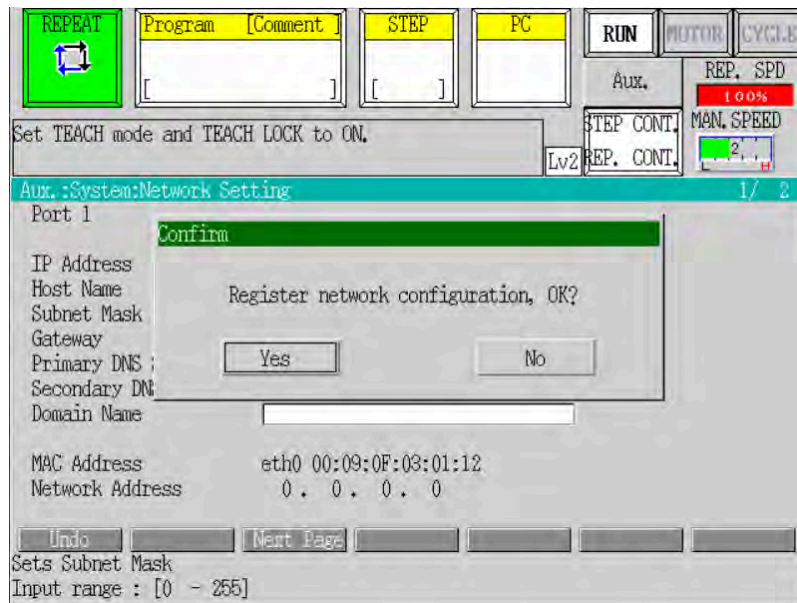

SIGNING IN TO FORGE/OS

Follow these steps to pair the READY pendant with the IPC and sign in to Forge/OS 5.

- 1 If you need to install Forge/OS 5 on your IPC, stop here and follow all the steps in [Appendix A](#), then come back to these steps.

Tip: Forge/OS 5 is installed on all Forge/Ctrls and Forge/Hubs shipped after June 1, 2021.

- 2 The READY pendant automatically finds and pairs with the IPC. The three LEDs on the screen help you track the status:

- **Pendant Network Connection:** This condition is satisfied when the READY pendant has a valid network connection (i.e., the Ethernet cable is plugged in).
- **Forge/OS IPC Detected:** This condition is satisfied when the READY pendant detects a Forge/OS IPC on the network.
- **Forge/OS IPC Paired:** This condition is satisfied when the READY pendant successfully pairs with the IPC. If pairing fails, it is automatically retried indefinitely.

When a condition is not satisfied, the LED is red. When a condition is in progress of becoming satisfied, a spinner around a READY logo appears to the right of the text. When a condition becomes satisfied, the LED turns green.

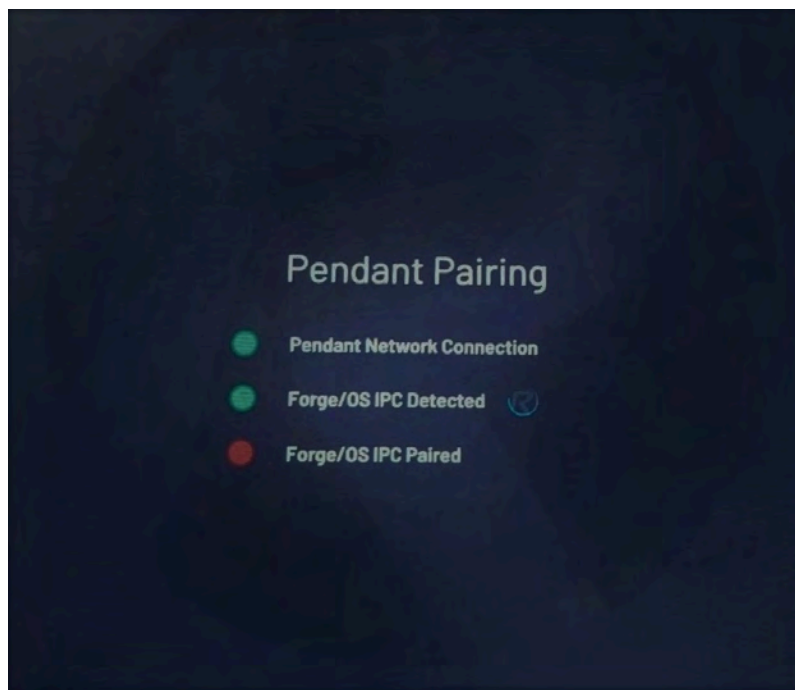

The UI shows the real-time state of each step. For example, if the pendant loses its network connection during

pairing, all steps become undone.

If the READY pendant spends more than 60 seconds on any step, troubleshooting text displays. Common things to check are if the READY pendant network cable is plugged in, if the IPC is powered on, if the READY pendant and IPC are connected to the same network, and if there's only one READY pendant and one IPC on that network.

3 Tap **Admin** and sign in. The default Admin password is "forgeadmin".

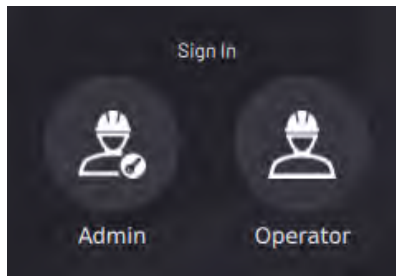

4 If Forge/OS is inactive, it opens the Settings app and prevents you from opening other apps. If you see the screen below, follow [Activating Forge/OS with a License Code](#) in Appendix A.

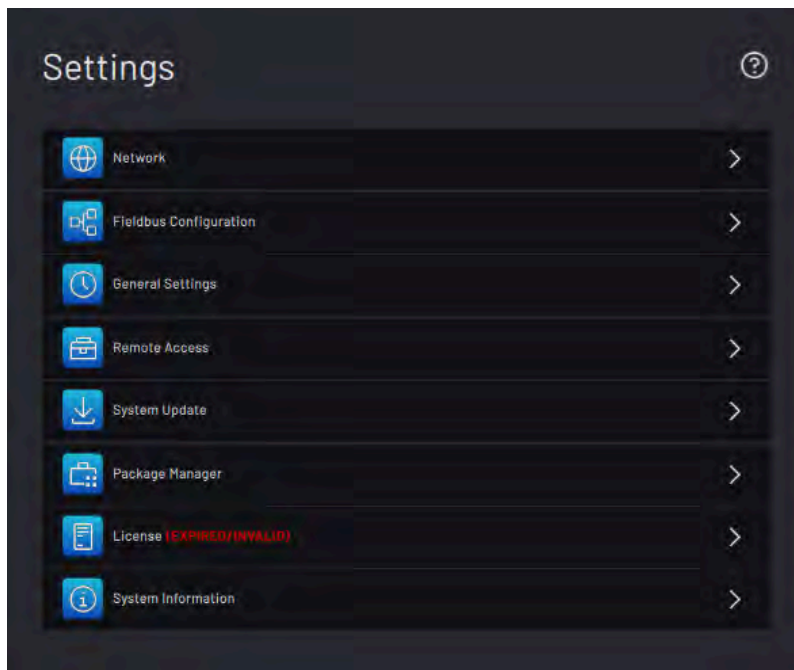

5 With Forge/OS active, move on to the next section.

GETTING THE CUBIC-S FILE FROM FORGE/OS

In these steps you start to add the robot in Forge/OS and get a Cubic-S parameters file based on your selected robot.

- 1 In the **Admin** role, open the **Device Configuration** app.



- 2 Tap **New +** to open the Device Library.

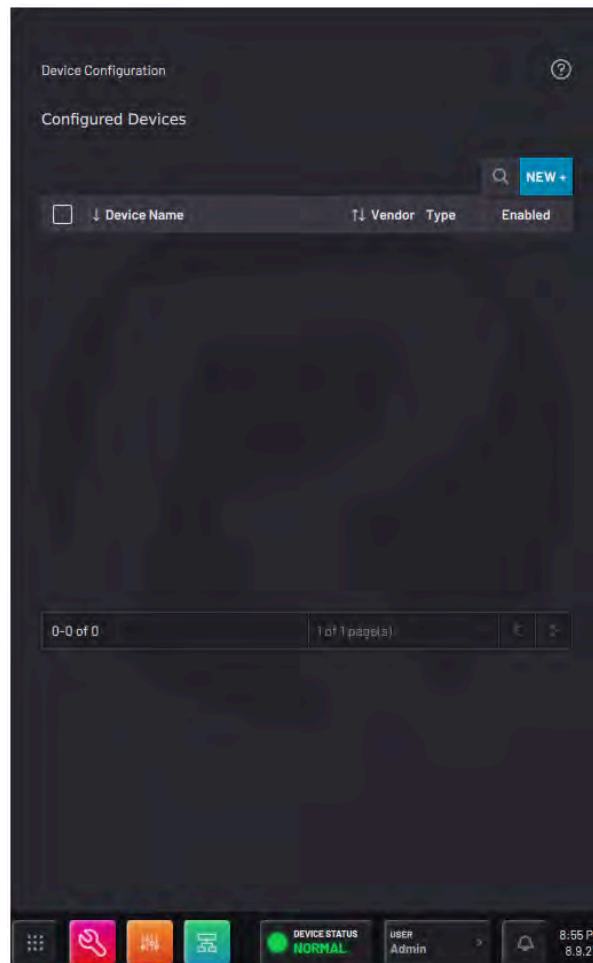

- Use the **Filter by** dropdown to show robot options. Select the **Kawasaki industrial robot** option and tap **NEXT** to continue.

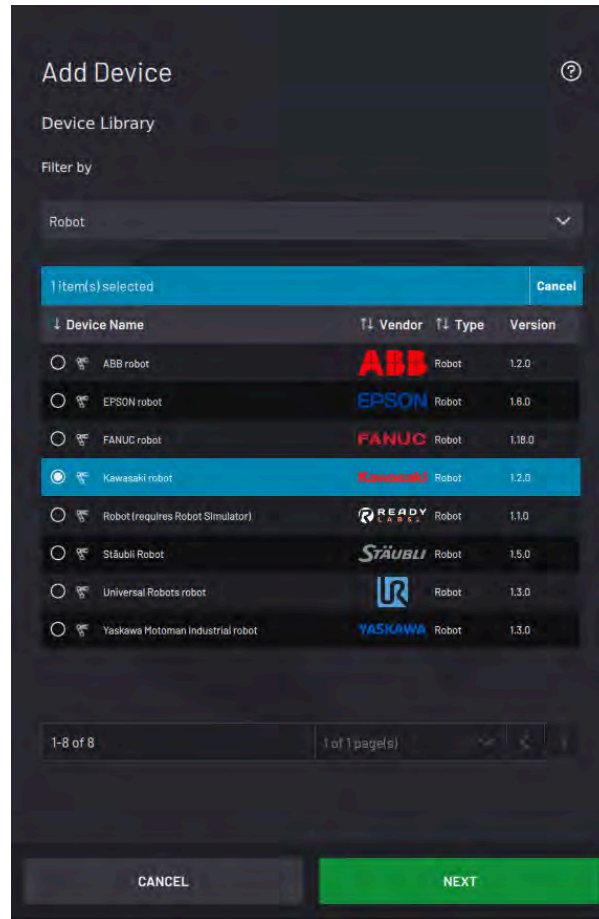

- 4 Select the robot controller model, then select the robot model. You can fill in the other information later.

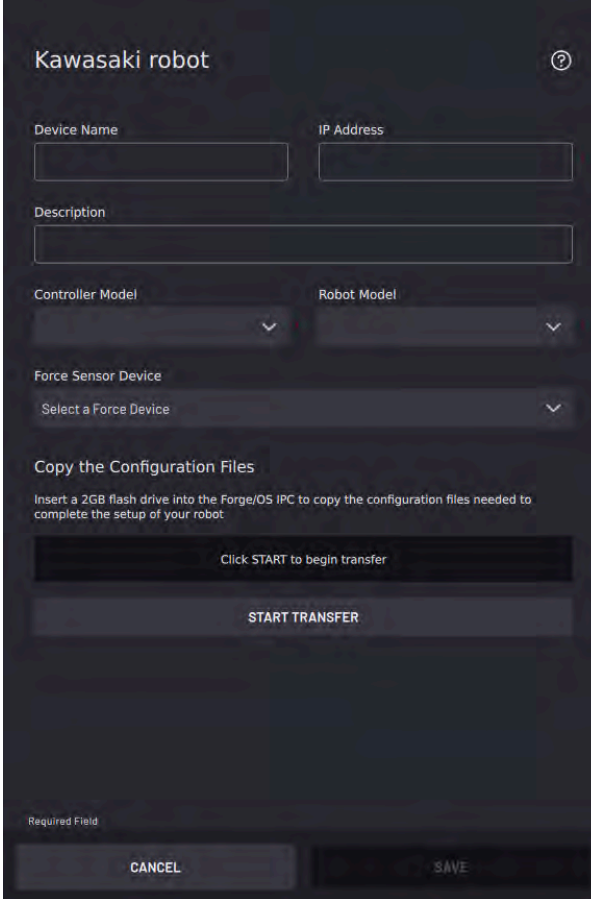

Kawasaki robot

Device Name IP Address

Description

Controller Model Robot Model

Force Sensor Device
Select a Force Device

Copy the Configuration Files

Insert a 2GB flash drive into the Forge/OS IPC to copy the configuration files needed to complete the setup of your robot.

Click START to begin transfer

START TRANSFER

Required Field

CANCEL SAVE

- 5 Insert a USB flash drive into the IPC as instructed on the screen. Use an empty flash drive with at least 2GB of storage.

Tip: Do not connect the USB flash drive to the **READY pendant**.

- 6 Tap **Start Transfer** and wait for it to finish.
- 7 Remove the USB flash drive when prompted.

TRANSFERRING CUBIC-S PARAMETERS

In this section you transfer the Cubic-S parameters file from Forge/OS to the Cubic-S unit in the Kawasaki controller.

- 1 Find your Type A-to-B USB 2.0 cable. Connect the USB B-side of the cable to the Cubic-S port on the front of the Kawasaki controller.
- 2 Connect the USB A-side of the cable to your Windows PC with CS-Configurator installed on it.
- 3 Connect the USB flash drive with the Cubic-S file to the Windows PC.
- 4 On the Windows PC, open CS-Configurator.
- 5 In the Operation Menu, click **Open File**. Then find the and open the file called "CubicSConfig.txt" on the USB drive (*USB-Drive:\forge-os\ready-kawasaki-driver\CubicSConfig.txt*).

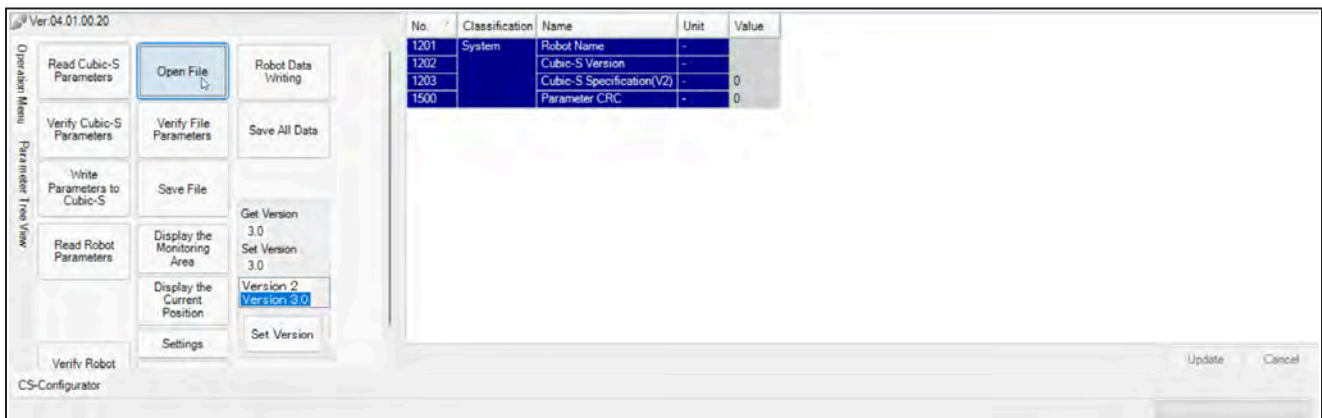

- 6 In the Operation Menu, click **Read Robot Parameters**. This reads robot information from the robot controller. It may take up to 30 seconds.

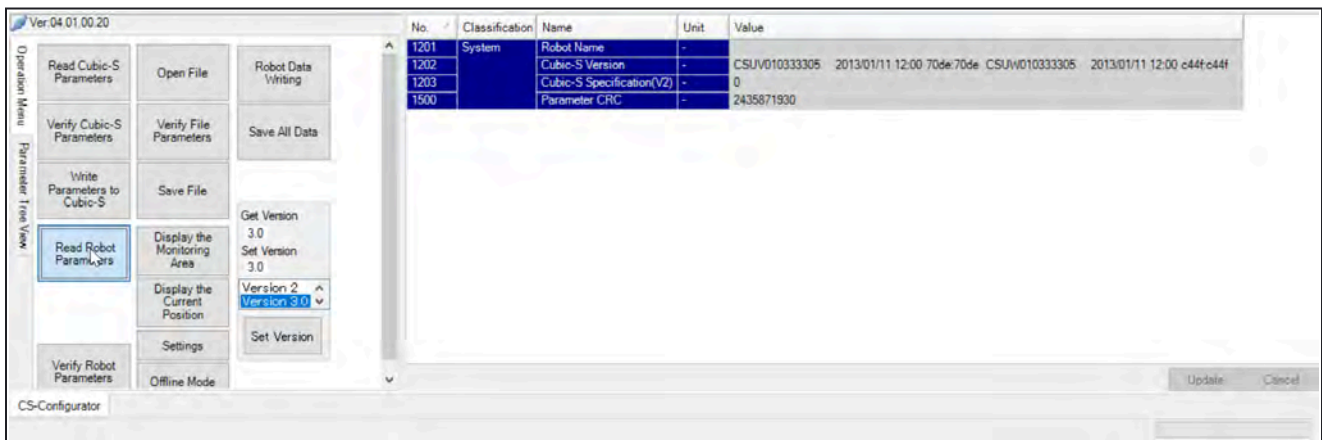

Note: If this is your first time connecting to the Kawasaki controller, you need to install the **Kawasaki USB driver**. Follow **Kawasaki Cubic-S instructions** for installing the USB communication driver.

7 In the Operation Menu, click **Read Tool Data**. This reads tool information from the robot controller.

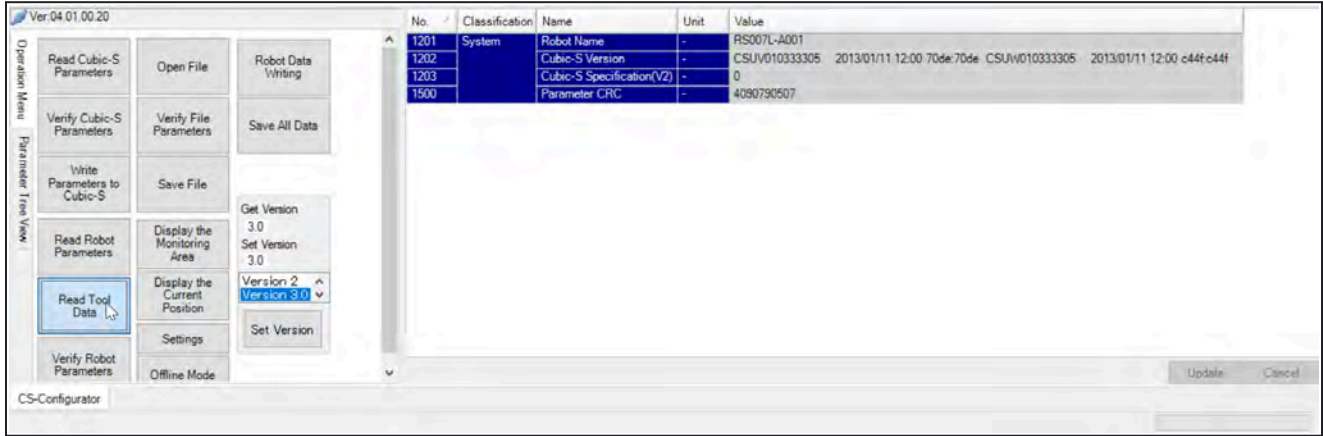

8 In the Parameter Tree View, expand **Monitoring Common Settings**. Click **Tool ID/ No. Table**. Map the Tool No.'s to what's listed in the image below (with Tool0 = 10, Tool1 = 11, Tool2 = 12, ... Tool7 = 17, Tool8 = 10, Tool9 = 11, ... Tool15 = 17, Tool16 = 10, ... Tool23 = 17, Tool24 = 10, ... Tool31 = 17). Then click **Update**.

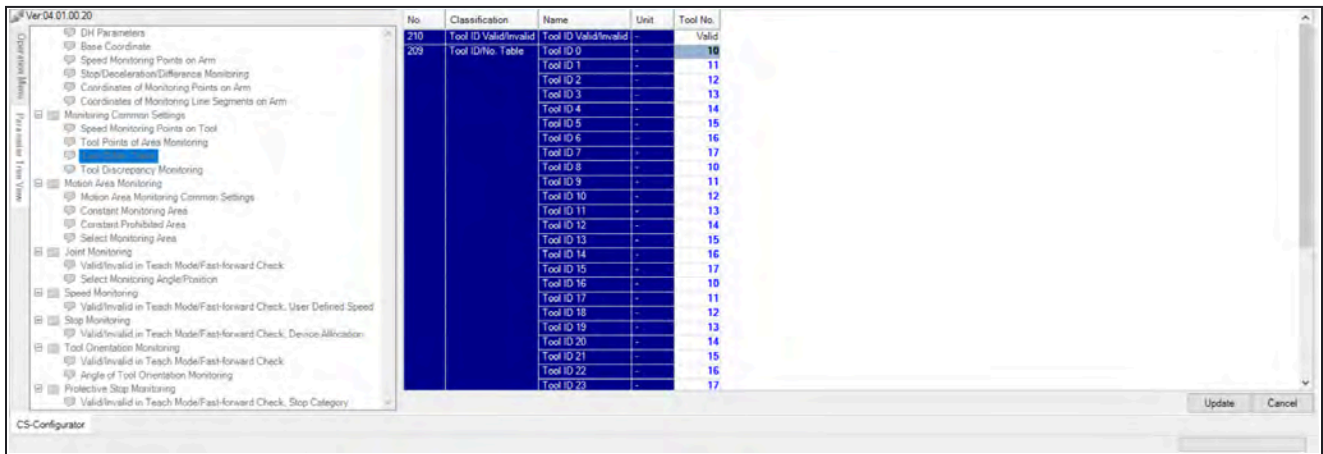

- 9 In the Operation Menu, click **Write Parameters to Cubic-S**. This saves the safety information to the Cubic-S unit.

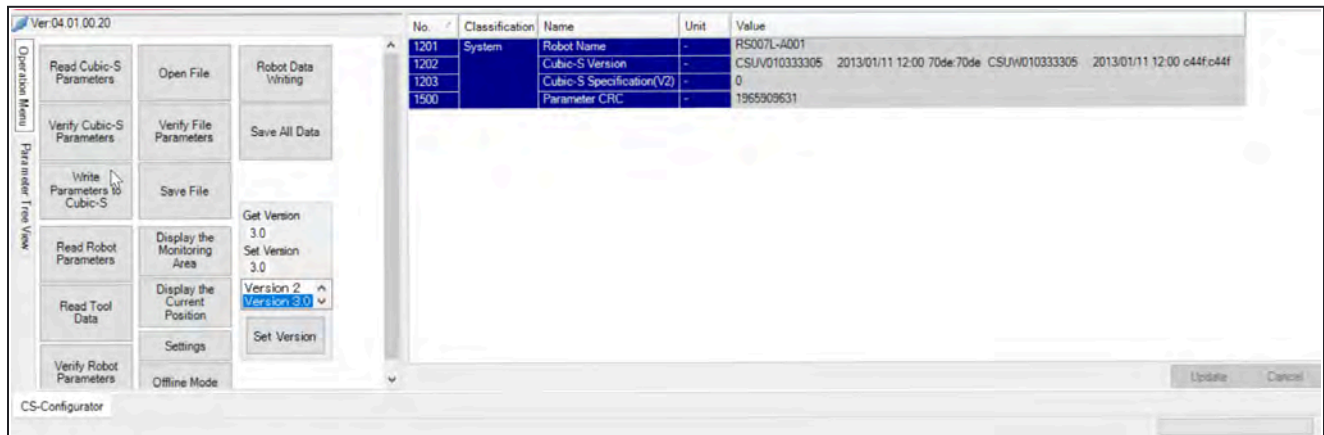

- 10 CS-Configurator asks you to enter your password. Enter the password (the default password is "khi"). Wait for the writing to finish.

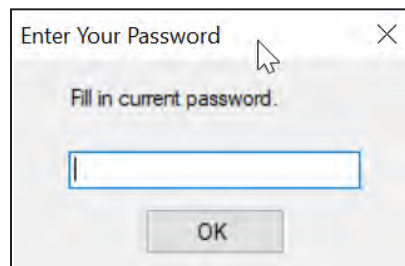

- 11 When you see "Writing to Cubic-S is done," wait for at least 5 seconds, then power off the robot controller.
- 12 Wait for at least 5 seconds, then power on the robot controller.
- 13 Disconnect the USB A-to-B cable from your Windows PC and the Cubic-S port.

ADDING THE ROBOT IN DEVICE CONFIGURATION

In these steps, you save the robot in the Device Configuration app and finish the setup.

1 In Forge/OS, finish entering your device information:

a Give your device a name.

b If you are using the READY-made **Forge/Ctrl**, enter the IP Address **172.16.255.251**. If you are using the READY-made **Forge/Hub**, enter the IP Address **192.168.1.20**. If the IP address you assigned to the robot is different, enter that.

2 In Forge/OS, confirm your device settings and tap **SAVE**. Forge/OS attempts to connect with the robot controller for up to 20 seconds.

Note: When you first connect to a robot, it's normal to see some robot errors and/or warnings on the **READY pendant**. Ignore these for now. You will clear them after you finish adding the robot to Forge/OS.

a If the robot controller fails to connect, you see this pop-up.

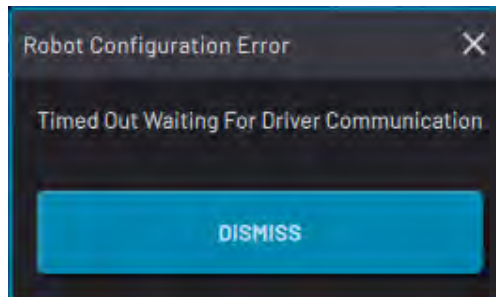

Click **DISMISS**, do the following, then try to tap **SAVE** again:

- Check the Ethernet connection between the robot controller and IPC.
- Check the network settings on the robot controller.
- Check if the robot controller is on and in the correct operating mode (in auto or remote mode).
- Select the correct robot controller and robot models in Device Configuration.

3 When the robot connects, you can add Tool Center Points (TCPs) or Payloads for the robot. You can come back to this later by editing the device's configuration. Tap **SAVE** to continue.

Note: The default TCP is at the robot's tool flange. The default Payload is zero.

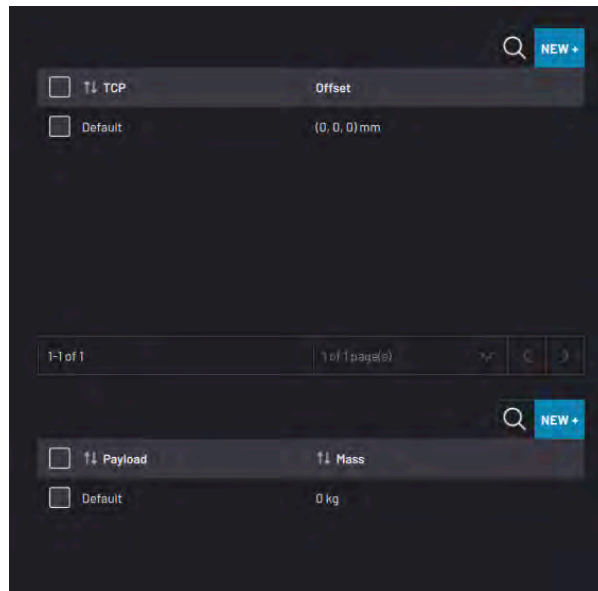

4 (Optional): Set up the robot controller's Input/Output (IO) signals for use in the Device Control Panel and Task Canvas.

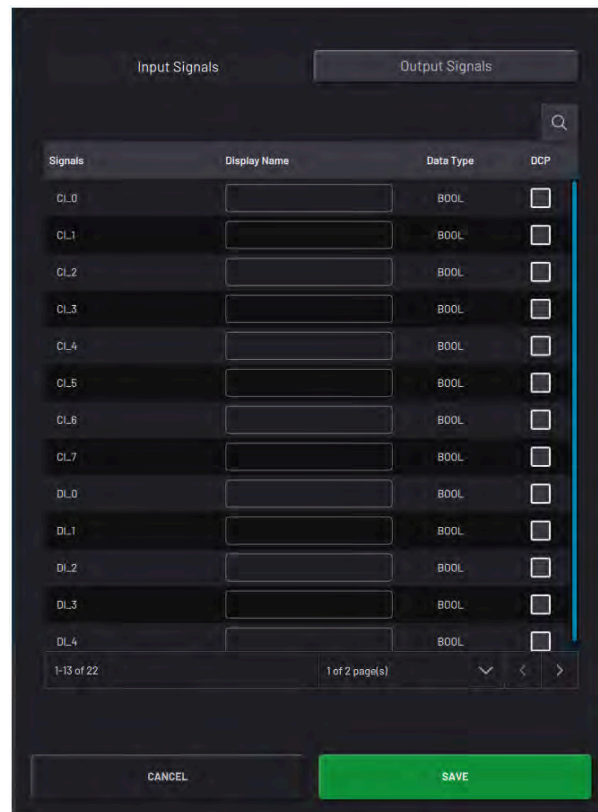

a Enter a **Display Name** (i.e. "Open Machine Door", "Open Pneumatic Vise", or "Start Machining Cycle") to show what each signal does in other apps.

b If you want a signal to appear in the Device Control Panel, check the **DCP** box next to that signal.

***Note:** To use these I/O signals, integrate your I/O devices with the robot controller.*

c Tap **SAVE**. Forge/OS returns to the Configured Devices list, which shows the new robot as **enabled**.

***Note:** A device is **enabled** when its switch is green and toggled to the right.*

5 Follow these steps to clear robot errors:

a Tap the **Device Status** button on the Toolbar to expand the Device Status Panel. The robot is listed with two buttons: **MORE** and **RESET**.

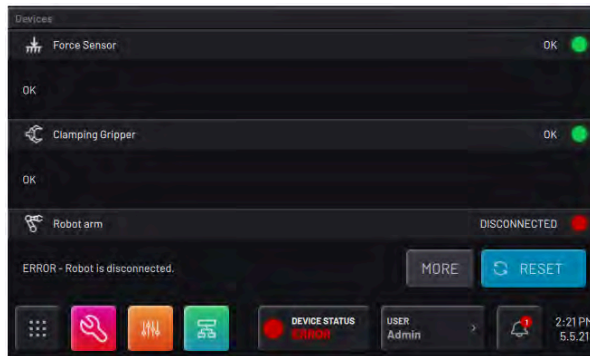

b Tap **RESET** to try to recover from the errors. If you can't **RESET** an error, tap **MORE** to get more details and instructions.

6 Review [Appendix B: Tool Loading Steps](#). Refer to those steps whenever you create new Tool Center Points or Payloads. To save time, find all the TCPs and Payloads you need for your application and add them all at once.

Congratulations! You are ready to control your robot in the Device Control Panel and Task Canvas apps.

APPENDIX A: SETTING UP FORGE/OS

INSTALLING FORGE/OS

Follow these steps to install Forge/OS and sign in to the Admin role. Installation takes about 30 minutes, depending on the resources of the IPC.

- 1 To install Forge/OS, follow these substeps. You need a Forge/OS installation USB flash drive. Contact your READY Robotics distributor for an installation USB drive.

Important: Installing Forge/OS will erase all data on the target hard drive.

- a Connect a monitor, keyboard, and mouse to the IPC where you want to install Forge/OS.



- b Plug the Forge/OS installation USB flash drive into the IPC.

Tip: If you need more USB ports, use a USB 3.0 hub.

- c Restart the IPC. While the IPC is powering on, press the keyboard hotkey that takes you to the Boot Menu.

Tip: The key that opens the Boot Menu depends on the **IPC** model. The most common keys that do this are ESC, F10, F11, or F12. Refer to your computer's documentation for boot options.

Note: If you're installing Forge/OS on a **Forge/Ctrl**, press F11. You may need to enter the **BIOS Admin password**. Contact READY Support if you run into this issue.

- d From the boot options, select **Install Forge/OS** to boot from the installation USB flash drive.

e The installer may take several minutes to load. Wait until the installation wizard opens.

f Select your language. Then click **Install Forge**.

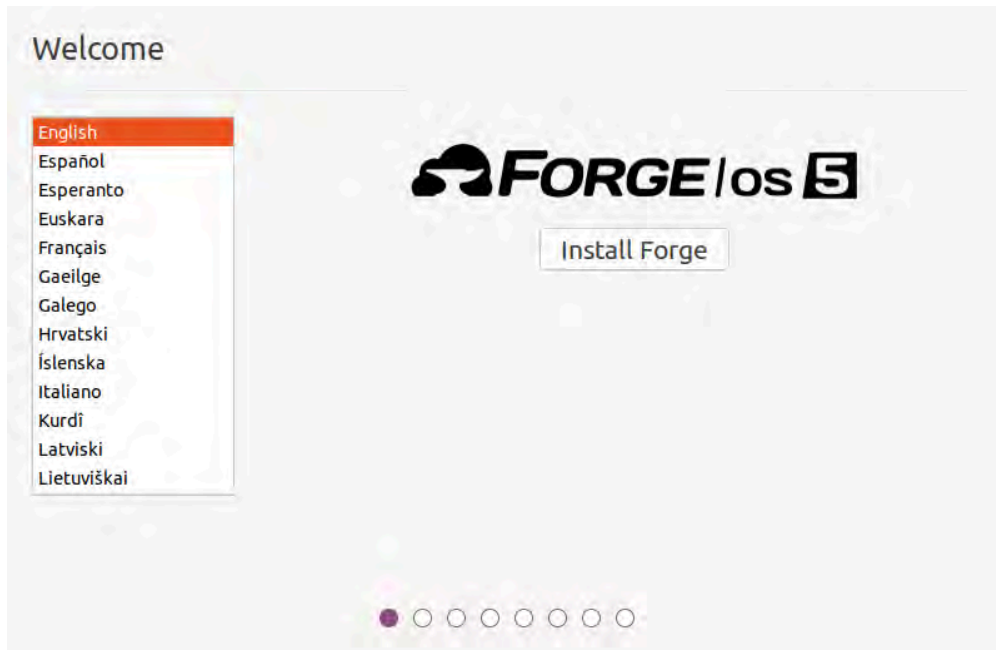

g Choose a keyboard layout. Then click **Continue**.

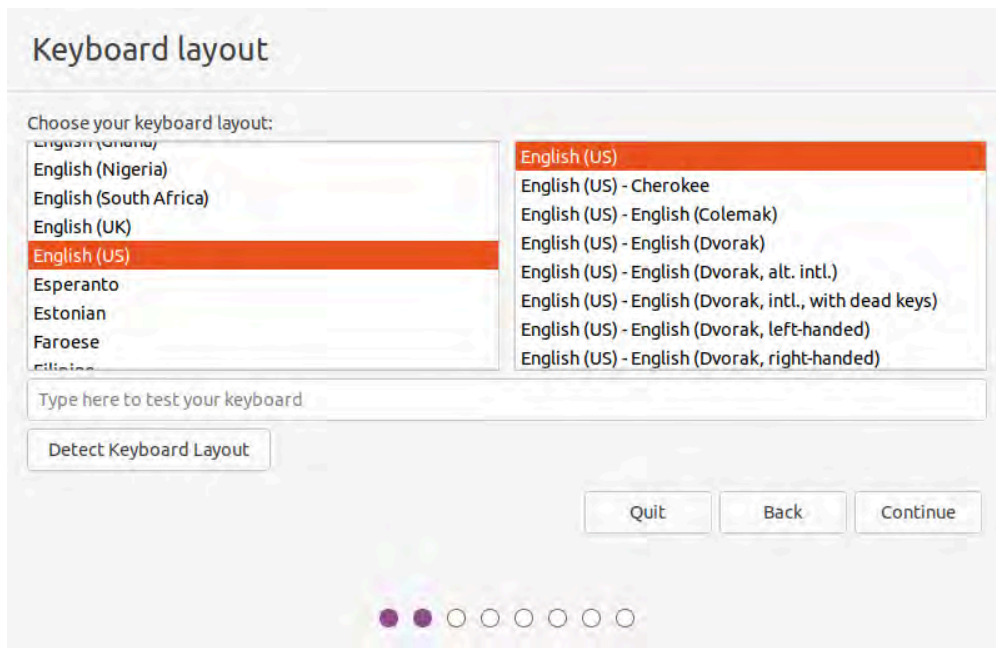

h

Select **Minimal installation**. Uncheck **Download updates while installing forgeos**. Then click **Continue**.

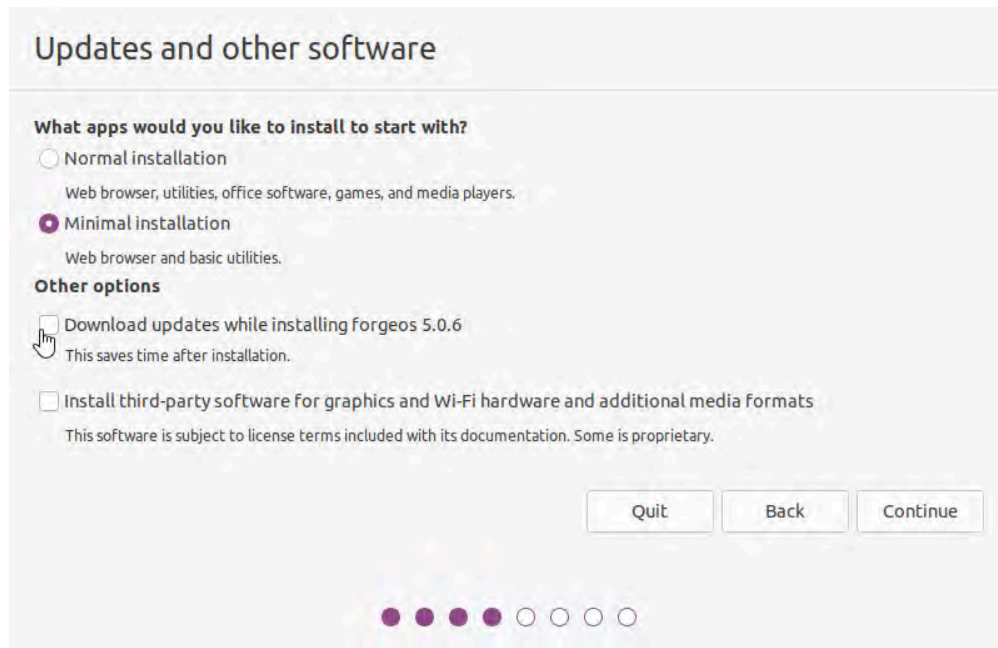

i

Select **Erase disk and install forgeos**. Then click **Continue**.

Note: If Forge/OS is already installed, the installation wizard will show additional options. The goal is to erase the entire disk for a brand new installation.

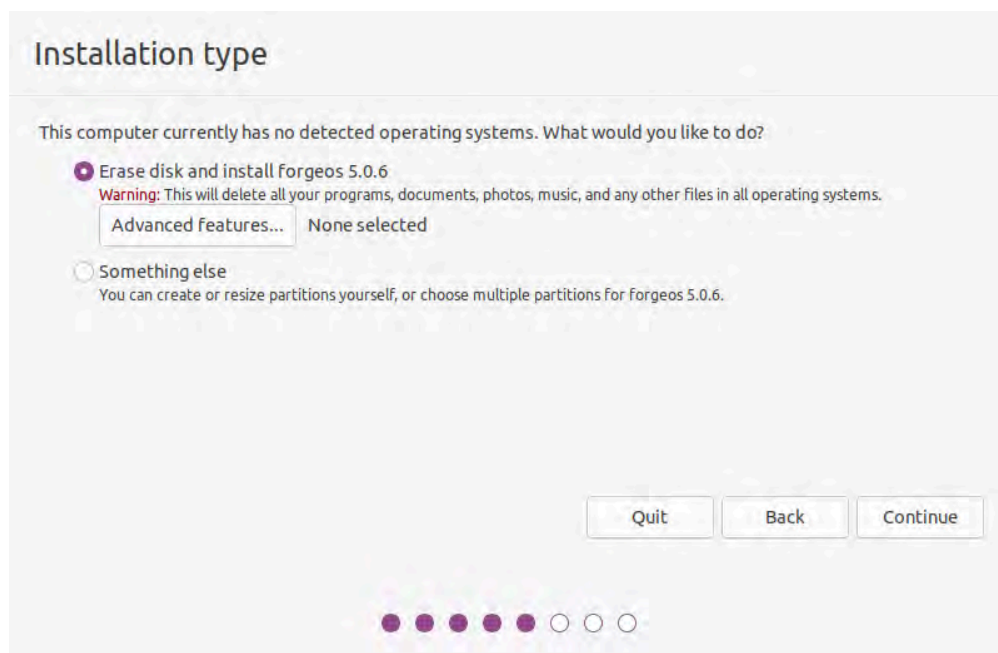

j Select the IPC hard drive for Forge/OS and click **Install Now**.

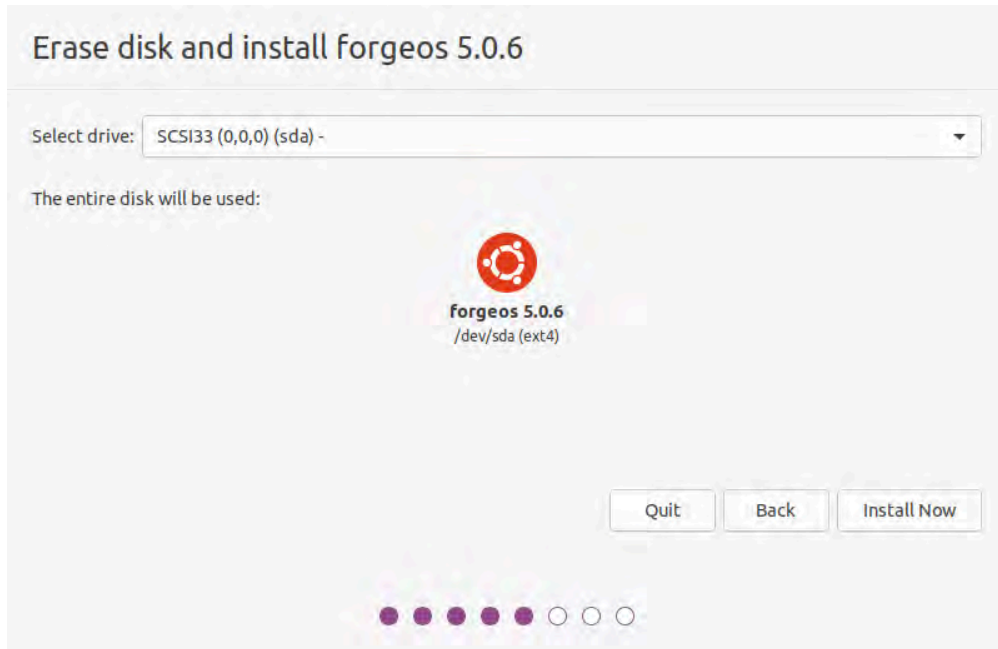

k Confirm that you want to erase the entire disk by clicking **Continue**.

l Make a note of the pendant instructions. If you're using a Forge/Ctrl, select the checkbox next to **This hardware is a Forge CTRL**.

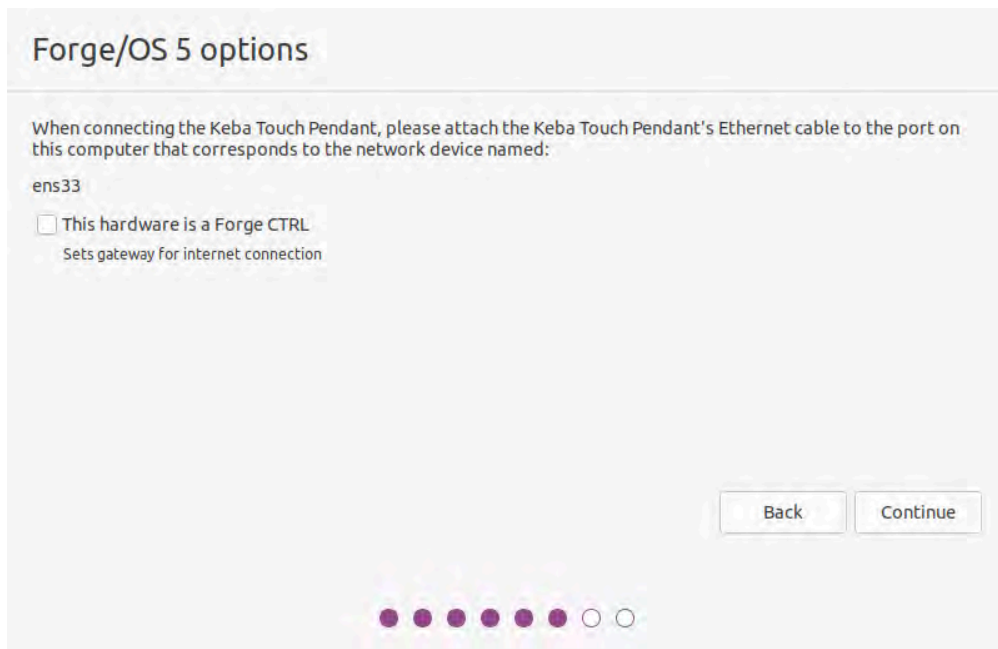

m Choose your timezone. Then click **Continue**.

n Choose your IPC's host name. The host name identifies the IPC on the network. Pick a username and password. Then click **Continue**.

Note: The username and password that you create here are for accessing the IPC desktop. They are NOT for signing into Forge/OS on the **READY pendant**.

- o Wait for the installer to copy and install Forge/OS.

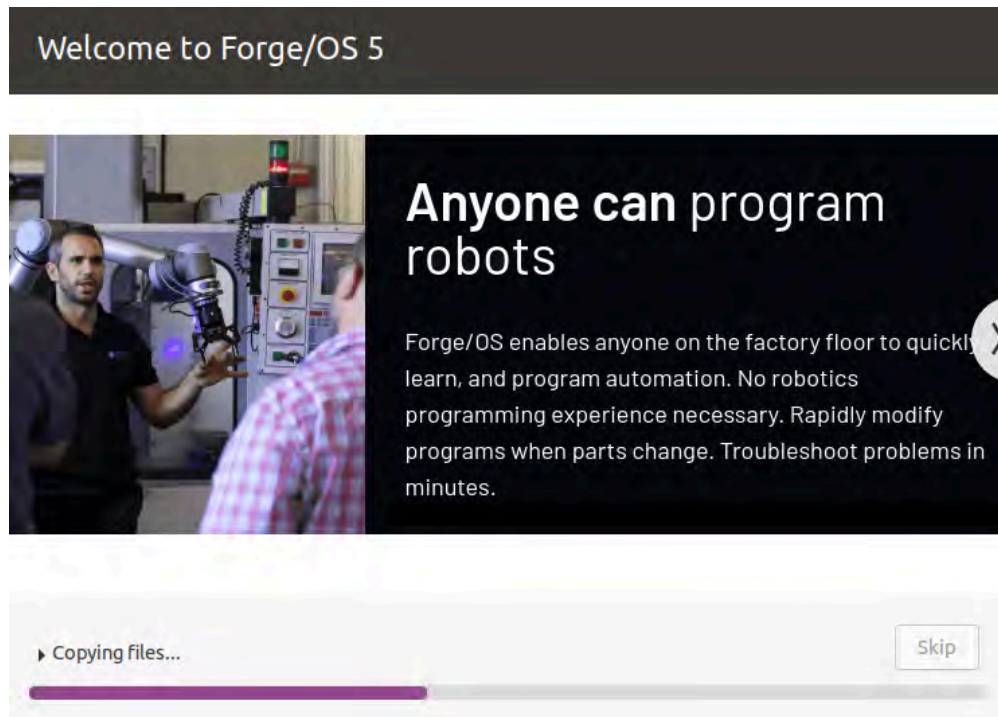

- p Once the installation completes, click **Restart Now**.

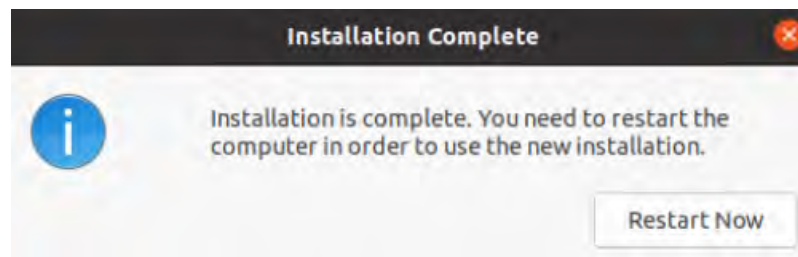

- q When prompted, remove the installation flash drive. Then reboot.

```
Please remove the installation medium, then reboot.  
_
```

- r Wait for Forge/OS to finish booting.

S

When you see the login screen with the Forge/OS 5 logo, Forge/OS is ready to run on the READY pendant! You don't need to sign in to the desktop. Disconnect the monitor, keyboard, and mouse that you used to install Forge/OS.

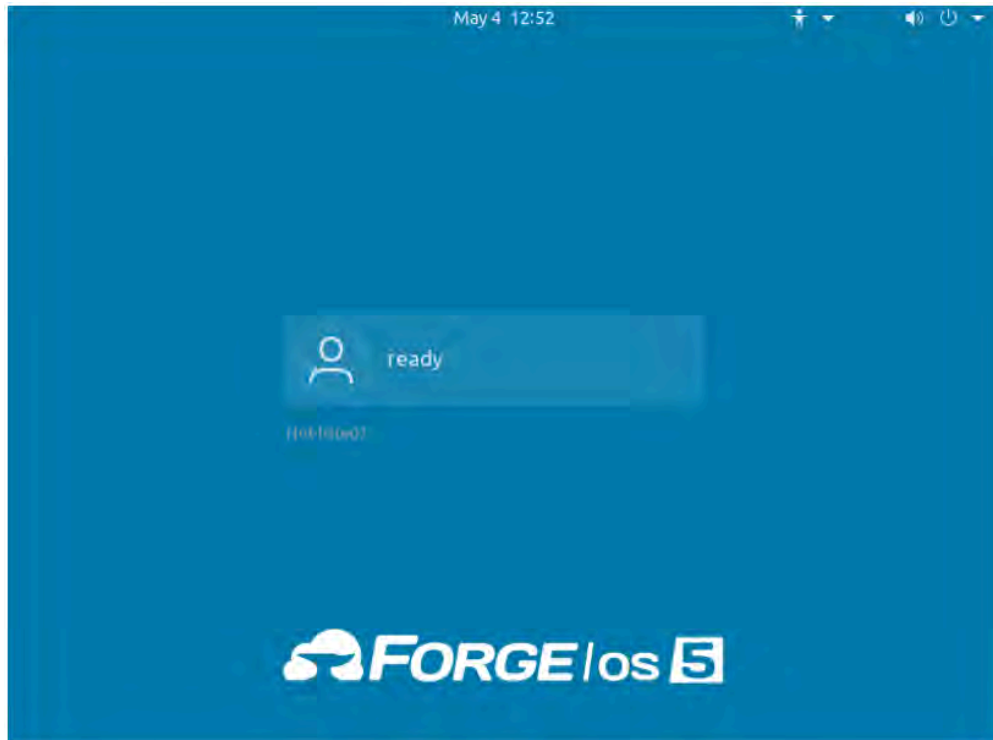

2 The READY pendant automatically finds and pairs with the IPC. The three LEDs on the screen help you track the status:

- **Pendant Network Connection:** This condition is satisfied when the READY pendant has a valid network connection (i.e., the Ethernet cable is plugged in).
- **Forge/OS IPC Detected:** This condition is satisfied when the READY pendant detects a Forge/OS IPC on the network.
- **Forge/OS IPC Paired:** This condition is satisfied when the READY pendant successfully pairs with the IPC. If pairing fails, it is automatically retried indefinitely.

When a condition is not satisfied, the LED is red. When a condition is in progress of becoming satisfied, a spinner around a READY logo appears to the right of the text. When a condition becomes satisfied, the LED turns green.

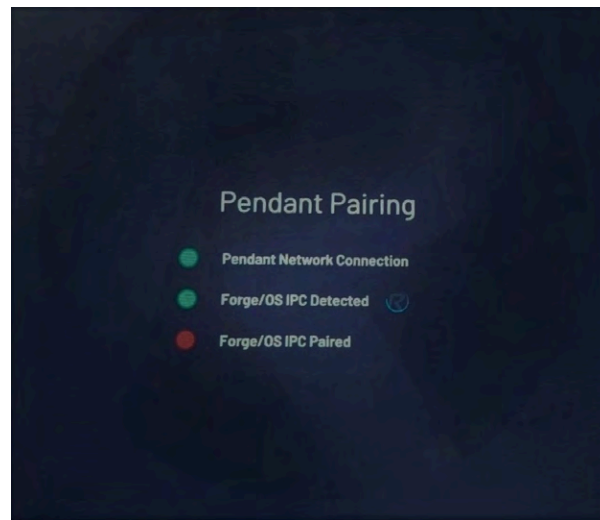

The UI shows the real-time state of each step. For example, if the pendant loses its network connection during pairing, all steps become undone.

If the READY pendant spends more than 60 seconds on any step, troubleshooting text displays. Common things to check are if the READY pendant network cable is plugged in, if the IPC is powered on, if the READY pendant and IPC are connected to the same network, and if there's only one READY pendant and one IPC on that network.

- 3 Tap **Admin** and sign in. The default Admin password is "forgeadmin".

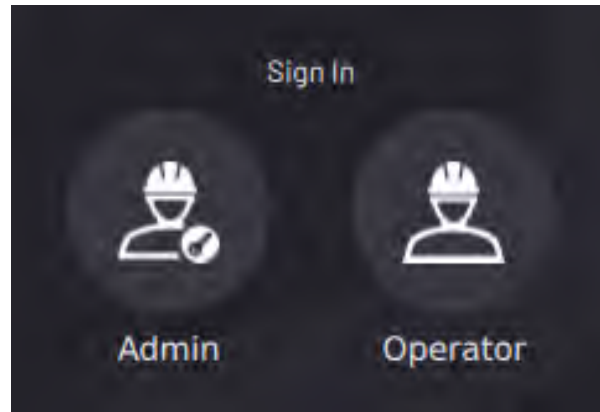

Note: After installation, you have limited access to Forge/OS until you activate it with a license code. See [Activating Forge/OS with a License Code](#).

ACTIVATING FORGE/OS WITH A LICENSE CODE

There are two methods to activate Forge/OS: **Online license activation** and **offline license activation**.

The table below lists the requirements for each method.

Online License Activation	Offline License Activation
<ul style="list-style-type: none"> ▪ An internet-connected Forge/OS ▪ A valid Forge/OS license code 	<ul style="list-style-type: none"> ▪ A 2GB or larger USB flash drive ▪ An internet-connected PC ▪ A valid Forge/OS license code

Tip: Connect a USB keyboard to the port on the bottom of the **READY pendant** to type in any text field in Forge/OS.

- 1 On the Settings app main screen, tap **License**.

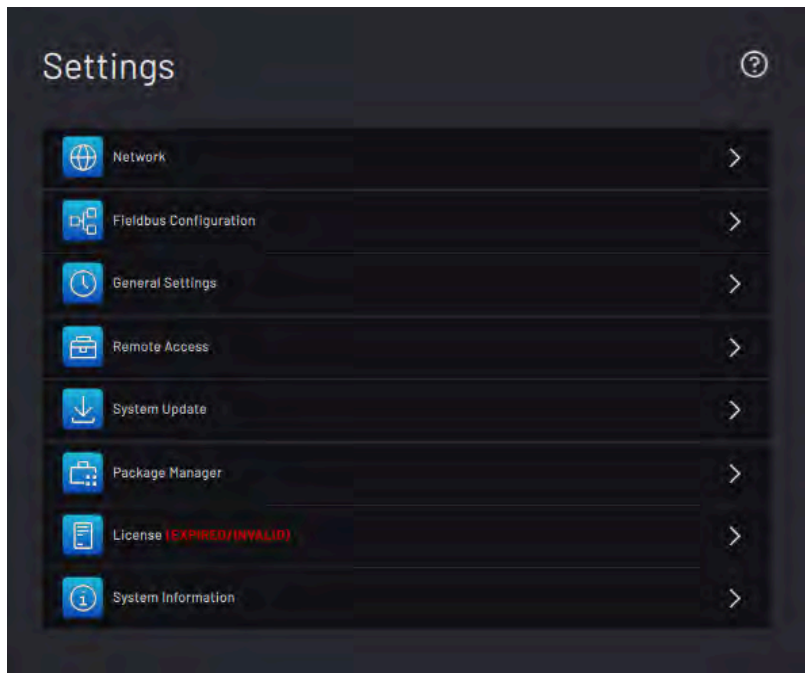

- 2 Type in your license code.

- 3 Choose **ONLINE LICENSE ACTIVATION** if Forge/OS is connected to the internet. If not, choose **OFFLINE LICENSE ACTIVATION**.

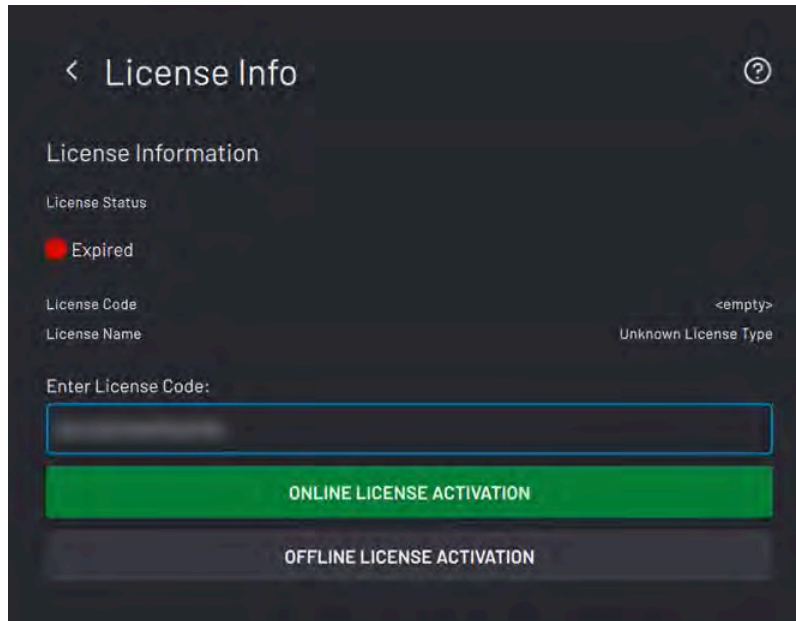

- 4 If you chose online license activation, you're done!

- 5 If you chose offline license activation, follow these substeps:

- a Insert the USB flash drive into your IPC. Tap **START WRITING CERTIFICATE TO USB DRIVE**.

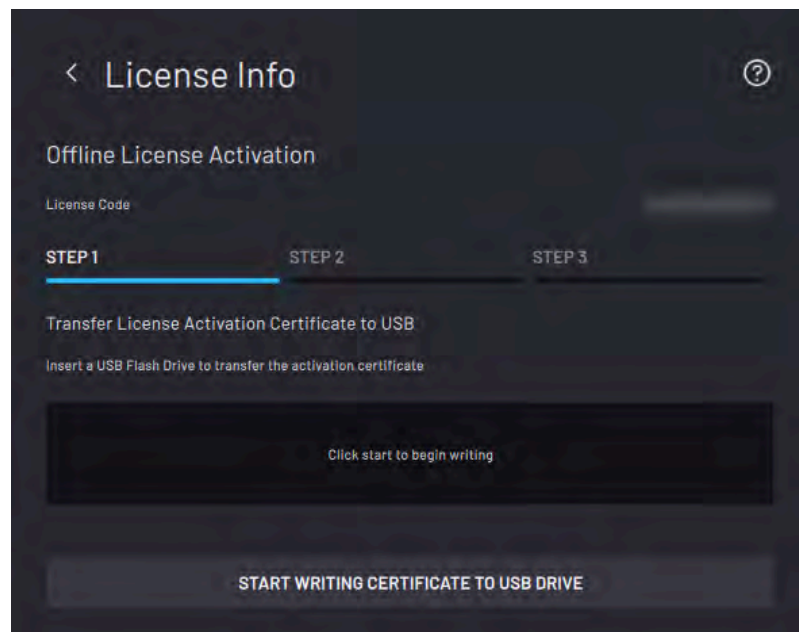

- b** When the files finish transferring, tap **NEXT**. Follow the instructions on the screen to convert the Activation Certificate to an Unlock Certificate using an internet-connected PC.

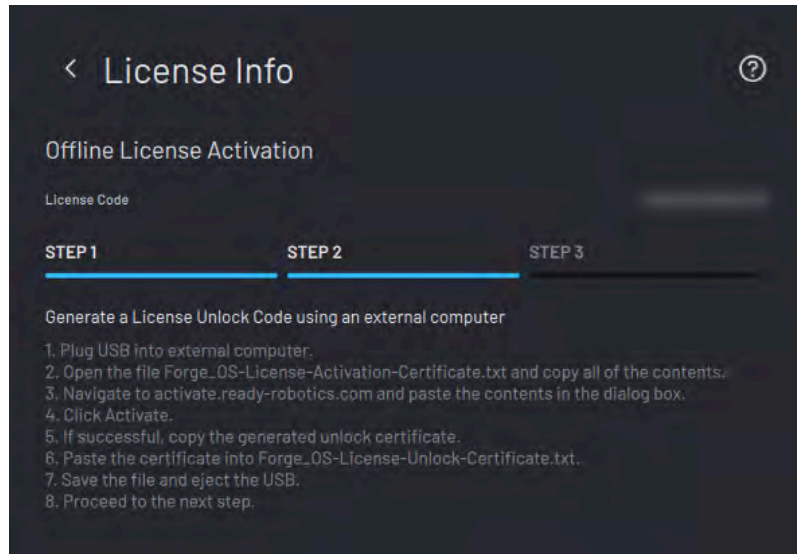

- c** Insert the USB flash drive back into your IPC. Tap **UNLOAD UNLOCK CERTIFICATE FROM USB DRIVE**.

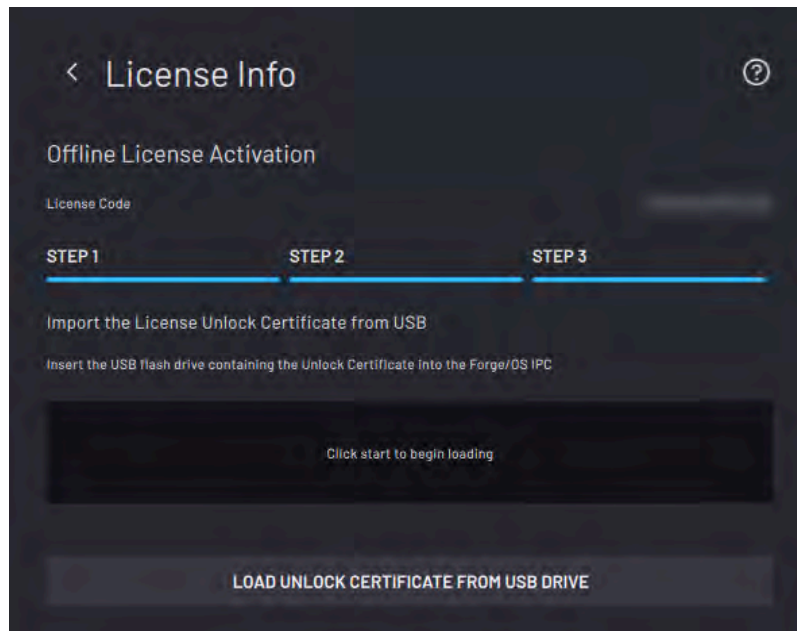

- d** Wait for the file to finish transferring. When the file transfer is complete, remove the USB flash drive and tap **SAVE**.
- e** Forge/OS returns to the licensing home screen and shows an active license. If the license status isn't active, restart these license activation steps. Double-check your license code.

CHOOSING PREFERENCES

These steps help you choose system preferences, including language, units, time, and network settings.

1 To change preferences for the first time, go to General Settings:

a On the Settings app main screen, tap **General Settings**.

b Change the Units of Measure, Time and Date settings, or the Admin login password.

Note: If you later forget your password, contact READY Robotics to reset it.

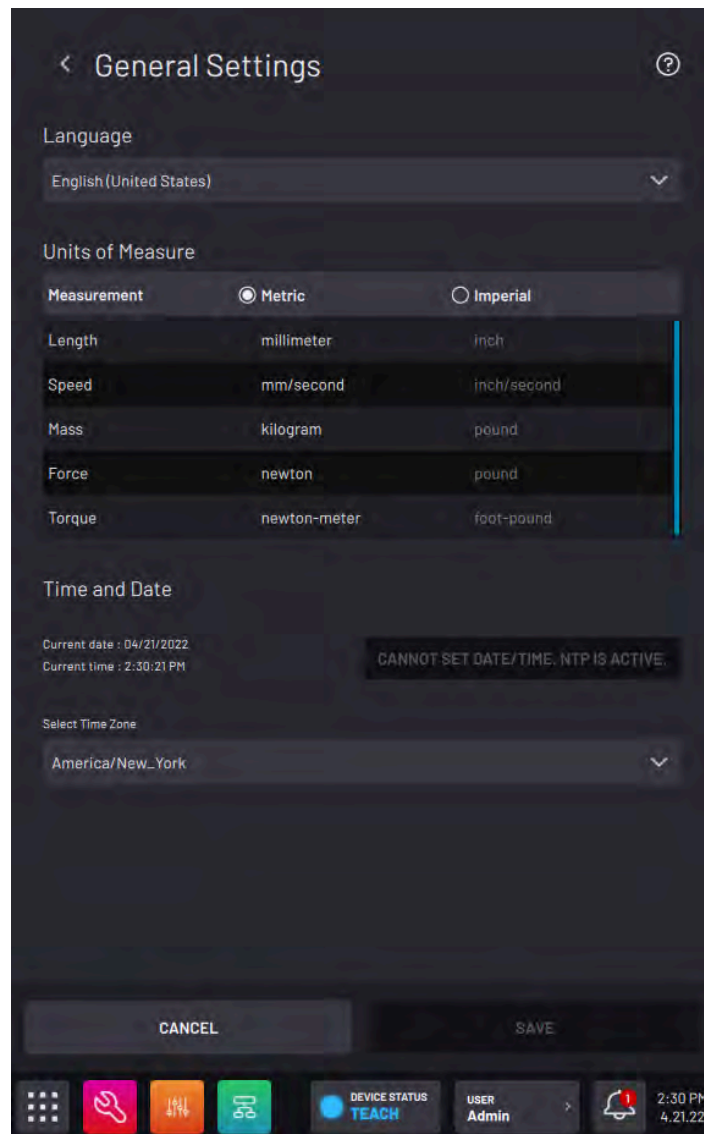

c Tap **SAVE** to save changes and exit the General Settings menu.

APPENDIX B: TOOL LOADING STEPS

Follow these steps each time you add new Tool Center Points (TCPs) or Payloads to the Kawasaki robot in Forge/OS. You may see an error in Forge/OS until you complete these steps and reset it.

Here is an outline of the tool loading process:

- Add TCPs/Payloads to the robot in Forge/OS.
- Connect your CS-Configurator PC to the Cubic-S unit.
- Read the Cubic-S, robot, and tool data in CS-Configurator.
- Write data to the Cubic-S unit in CS-Configurator.
- Restart the robot controller.

1 In Forge/OS, go to the Device Configuration app and find your Kawasaki robot. Select the device and tap **Edit** to open the robot configuration.

2 Tap **TCP AND PAYLOAD CONFIGURATION**.

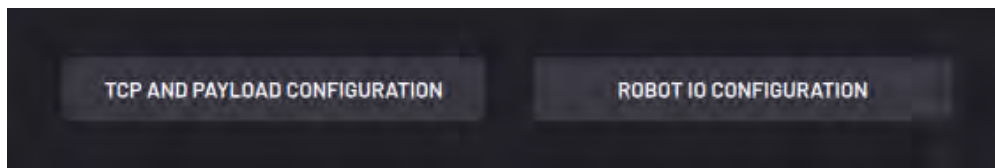

3 Add all the TCPs and Payloads you need for your workcell and tap **SAVE**.

Tip: See the Forge/OS User Manual for more about TCPs and Payloads.

4 Tap **SAVE** to exit the robot configuration.

5 Find your Type A-to-B USB 2.0 cable. Connect the USB B-side of the cable to the Cubic-S port on the front of the Kawasaki controller.

6 Connect the USB A-side of the cable to your Windows PC with CS-Configurator installed on it.

7 On the Windows PC, open CS-Configurator.

8 In the Operation Menu, click READ Cubic-S Parameters. This reads safety information on the Cubic-S unit.

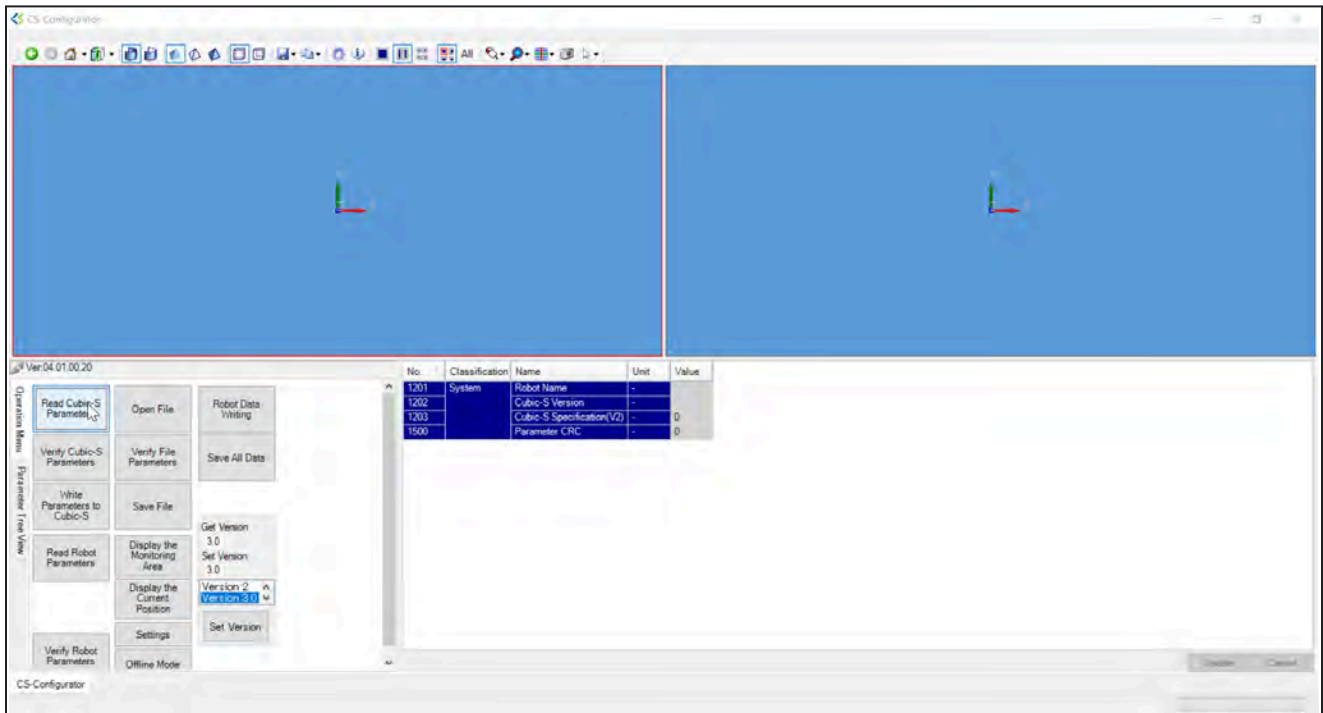

If you see "Reading for Cubic-S is done," click OK. If you see an error that reads "Connect USB," check your USB connection to the Cubic-S port.

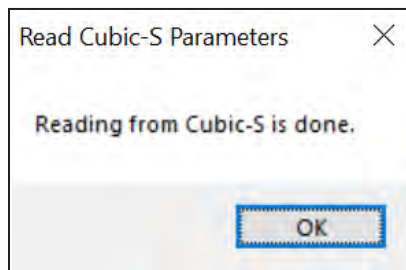

Note: If this is your first time connecting to the Kawasaki controller, you need to install the **Kawasaki USB driver**. Follow **Kawasaki Cubic-S instructions** for installing the USB communication driver.

- In the Operation Menu, click **Read Robot Parameters**. This reads robot information from the robot controller. It may take up to 30 seconds.

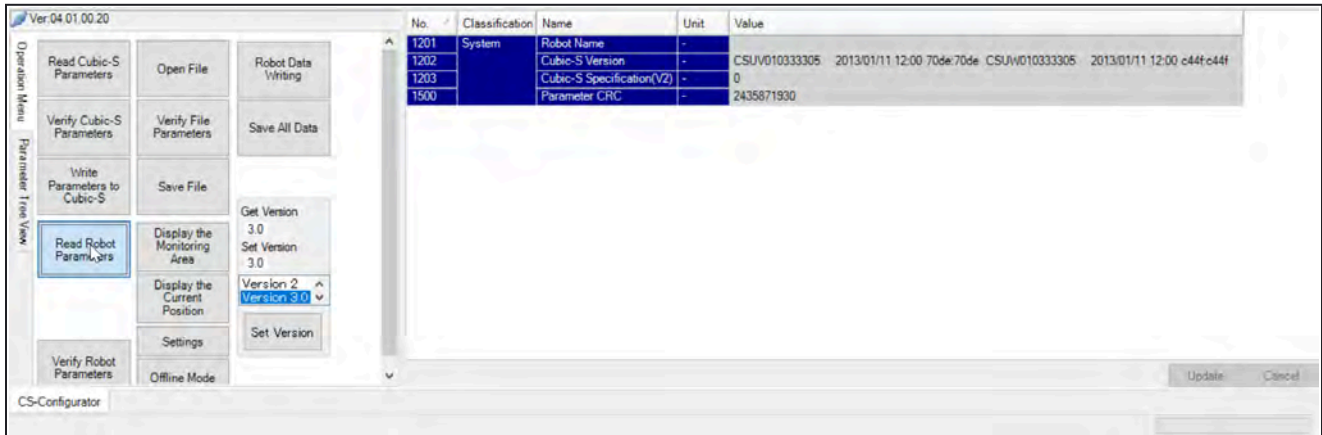

Note: If this is your first time connecting to the Kawasaki controller, you need to install the **Kawasaki USB driver**. Follow **Kawasaki Cubic-S instructions** for installing the USB communication driver.

- In the Operation Menu, click **Read Tool Data**. This reads tool information from the robot controller.

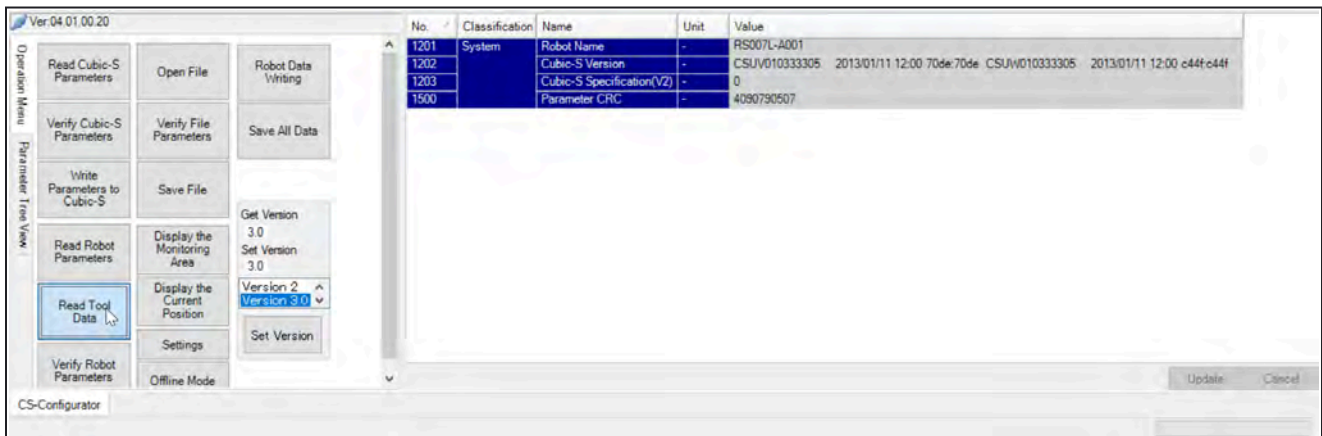

- 11 In the Parameter Tree View, expand **Monitoring Common Settings**. Click **Tool ID/ No. Table**. Map the Tool No.'s to what's listed in the image below (with Tool0 = 10, Tool1 = 11, Tool2 = 12, ... Tool7 = 17, Tool8 = 10, Tool9 = 11, ... Tool15 = 17, Tool16 = 10, ... Tool23 = 17, Tool24 = 10, ... Tool31 = 17). Then click **Update**.

Note: These tool assignments used to be different before Forge/OS 5.3 (since Forge/OS used to not support Tool Shapes). The above assignments enable you to use Tool Shapes.

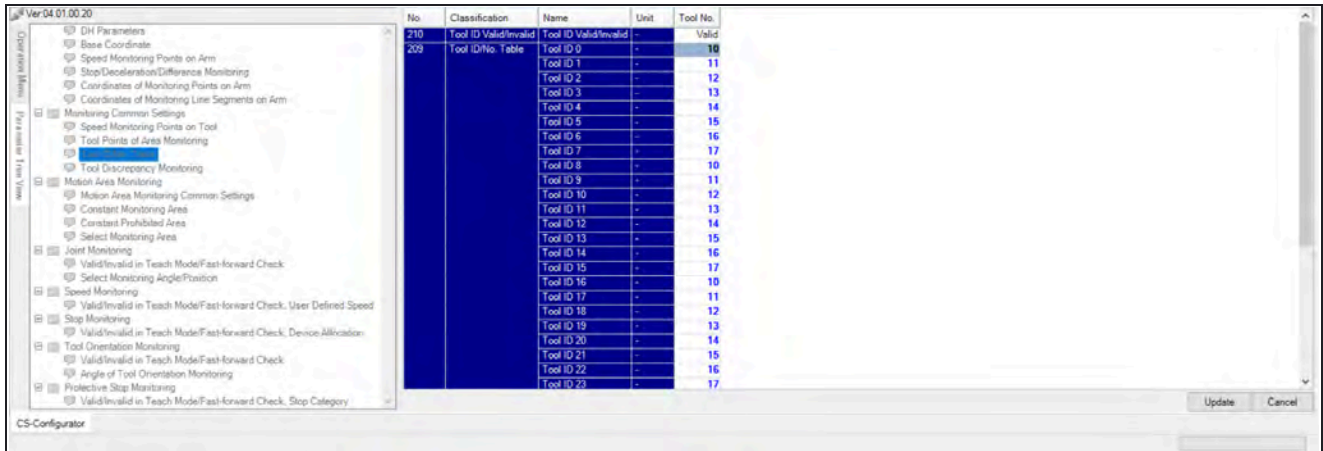

- 12 In the Operation Menu, click **Write Parameters to Cubic-S**. This saves the safety information to the Cubic-S unit.

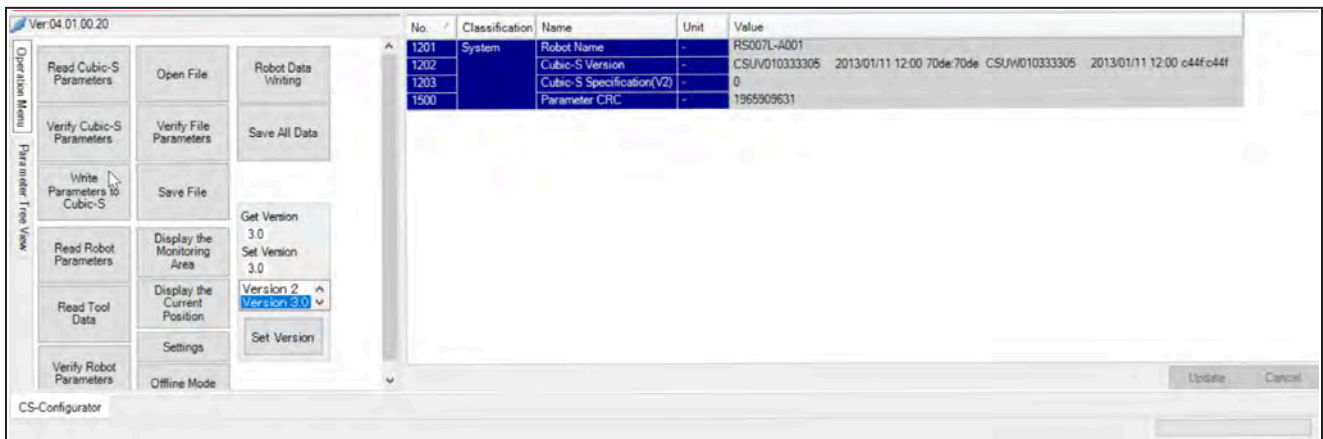

- 13 CS-Configurator asks you to enter your password. Enter the password (the default password is "khi"). Wait for the writing to finish.

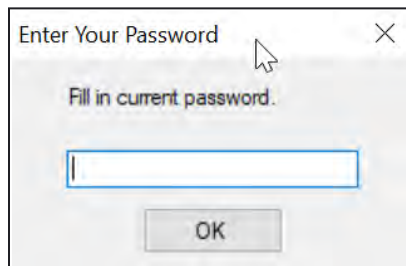

14 When you see "Writing to Cubic-S is done," wait for at least 5 seconds, then power off the robot controller.
.....

15 Wait for at least 5 seconds, then power on the robot controller.
.....

16 In Forge/OS, reset any warnings or errors.
.....

RESOURCES

Want to learn more about how Forge/OS can empower you?

Visit **READY.academy** (ready.academy) for *FREE* hands-on courses to help you deploy a robotic system.

Visit **READY.market** (market.ready-robotics.com) for products and services offered by READY and our partners.

Visit our **Support** site (support.ready-robotics.com) for robot startup guides, FAQs, and more.

Visit our **Resources** page (ready-robotics.com/resources) for articles, whitepapers, and other resources.

If you encounter a problem and need to talk to someone, reach out to us.

- Email READY Robotics: support@ready-robotics.com
- Call READY Robotics: +1-833-732-3977

