



Yaskawa YRC1000 Startup Guide



The documentation, best practices, and recommendations provided by READY Robotics do NOT constitute safety advice. Products sold through READY Robotics are not by themselves a fully integrated workcell. As required in ISO 10218-2, READY Robotics strongly recommends performing a complete risk assessment of the integrated workcell per ISO 12100. You may wish to use the methodology found in the ANSI/RIA TR R15.306 Task-based Risk Assessment Methodology.

# CONTENTS

- Overview ..... 4
- Hardware Requirements ..... 5
  - Confirming Hardware Requirements ..... 7
- Software Requirements ..... 9
  - Confirming Software Requirements ..... 10
- Back Up and Upgrade the Robot Controller ..... 14
- Connecting the READY pendant .....17
- Connecting to the IPC ..... 23
- Signing In to Forge/OS ..... 25
  - Powering On ..... 27
- Getting Robot Files from Forge/OS ..... 28
- Changing Robot Settings to Prepare for Forge/OS ..... 32
- Transferring Configuration Files ..... 44
- Adding your Robot in Device Configuration ..... 60
- Appendix A: Setting Up Forge/OS ..... 64
  - Installing Forge/OS ..... 64
  - Activating Forge/OS with a License Code ..... 73
  - Choosing Preferences ..... 76
- Appendix B: Tool Loading Steps ..... 77
- Appendix C: Troubleshooting ..... 83
- Resources ..... 87

# OVERVIEW

This guide helps you set up your Yaskawa Motoman controller to work with Forge/OS 5.

For specific software and hardware requirements, go to [support.ready-robotics.com](https://support.ready-robotics.com).

You will follow these steps:





1. Backup and update the Yaskawa controller.
2. Connect the READY pendant to your IPC and Yaskawa controller.
3. Power on your system.
4. Start up Forge/OS.
5. Get robot files from Forge/OS.
6. Make changes to Yaskawa settings and upload robot configuration files.
7. Finish Device Configuration in Forge/OS.

**Note:** This guide assumes you have installed the robot and robot controller following Yaskawa instructions. Make sure the robot controller is in working order before moving on.

**Tip:** For **non-collaborative** robots, the default Safety Mode password is "5555 5555 5555 5555"

# HARDWARE REQUIREMENTS

Image	Part Name	Description	Vendor	Part Number
	READY IPC	Hosts Forge/OS. <i><b>Note: READY offers two IPCs: Forge/Hub and Forge/Ctrl (legacy)</b></i>	READY Robotics	
	READY pendant	The touch screen interface for Forge/OS.	READY Robotics	112563
	READY pendant Junction Box ( <b>Forge/Ctrl only</b> )	Connects the READY pendant to the Forge/Ctrl and robot controller.	READY Robotics	R-101257
	12-Pin M12 to Flying Leads Cable	Connects to the READY pendant Junction Box or Forge/Hub to terminals.	READY Robotics	
	YRC1000 Robot Controller	Controls the robot in its native software.	Yaskawa	

Image	Part Name	Description	Vendor	Part Number
	Yaskawa Standard Pendant	Required for Forge/OS to load and set tools (payloads and TCPs).  <i><b>Note:</b> Forge/OS does NOT support the Smart Pendant.</i>	Yaskawa	177716-1
	Functional Safety Unit (FSU) Expansion Kit	Required to connect the READY pendant safety features and fence. Includes: <ul style="list-style-type: none"> <li>▪ FSU I/O Board</li> <li>▪ FSU I/O Breakout</li> <li>▪ FSU I/O Breakout Cable</li> <li>▪ FSU I/O Control Signal Cable</li> </ul>	Yaskawa	179909-1, includes: <ul style="list-style-type: none"> <li>▪ 178277-1</li> <li>▪ 179765-1</li> <li>▪ 183418-1</li> <li>▪ 176790-2</li> </ul>
	Yaskawa Standard I/O, 40 IN/40 OUT, 2 Safety IN/2 Safety OUT	Required to connect the READY pendant safety features and fence.	Yaskawa	180700-1
	Cat5e Shielded Ethernet Cable (x2)	<ul style="list-style-type: none"> <li>▪ Connects the robot controller to an IPC.</li> <li>▪ Connects the READY pendant to an IPC.</li> </ul>		
	USB flash drive, 8GB or larger	Required to transfer robot files from Forge/OS to the robot.  <i><b>Tip:</b> Use a different USB flash drive (2GB or larger) for backing up the Yaskawa controller.</i>	READY Robotics (or other)	R-400030

# CONFIRMING HARDWARE REQUIREMENTS

Follow these steps to check if you have the required Yaskawa safety hardware.

- 1 Power off the YRC1000. Follow your facility's lockout/tagout procedure.



- 2 Use a flat-blade screwdriver to turn the Yaskawa controller door lock clockwise. Open the door.

- 3 Look for the FSU I/O Expansion Board. It should have a cable connector labeled **CN222** on the board. If you don't see the cable headers or cable labeled **CN222**, you don't have the proper expansion board.

*Tip: You may see a General Purpose Safety I/O board, which will not work.*

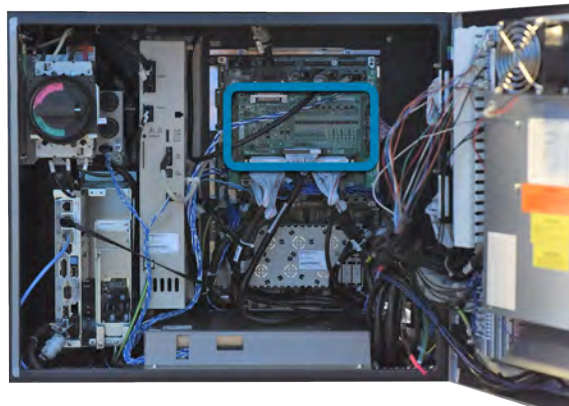

- 4 The Safety Unit I/O cable leads to the FSU Expansion Breakout Board on the Yaskawa controller door panel. Look for this Breakout Board with the connector labeled **CN220**.



- 5 If you don't have the required hardware, contact a Yaskawa Motoman distributor.
- 6 If you have the required hardware, move on to the next section.



# SOFTWARE REQUIREMENTS

Controller	Minimum Software Version
YRC1000	YAS4.10

## REQUIRED OPTIONS

Requirement	Part Number	Description
FSU Software Option (non-collaborative)	179908-1	Required to jog the robot with the READY pendant.

# CONFIRMING SOFTWARE REQUIREMENTS

Follow these steps to check the software version and options on your robot controller.

- 1 Plug the Yaskawa controller into a power source. Power the controller on and wait for it to boot up.



- 2 On the Yaskawa teach pendant, press the **MAIN MENU** button. Then press the black right arrow key until you have a gray menu on the left side of the screen.



3 Follow these steps to find the firmware version:

a Select **SYSTEM INFO**, then select **VERSION**.

*Tip: Use the arrows and **SELECT** button, or tap the screen to select.*

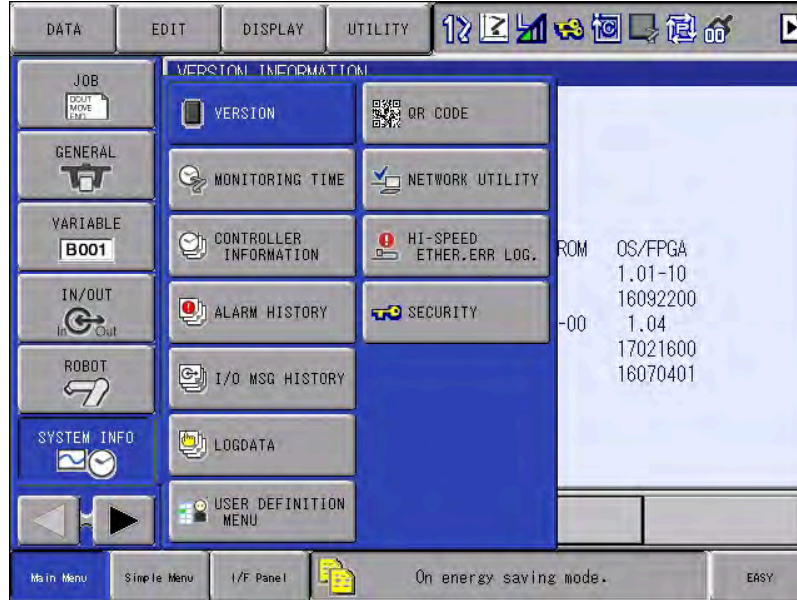

b The system version information appears on the screen. Look for the version number at the top by **SYSTEM**. If your system version is older than the requirement, contact your Yaskawa Motoman distributor to upgrade.

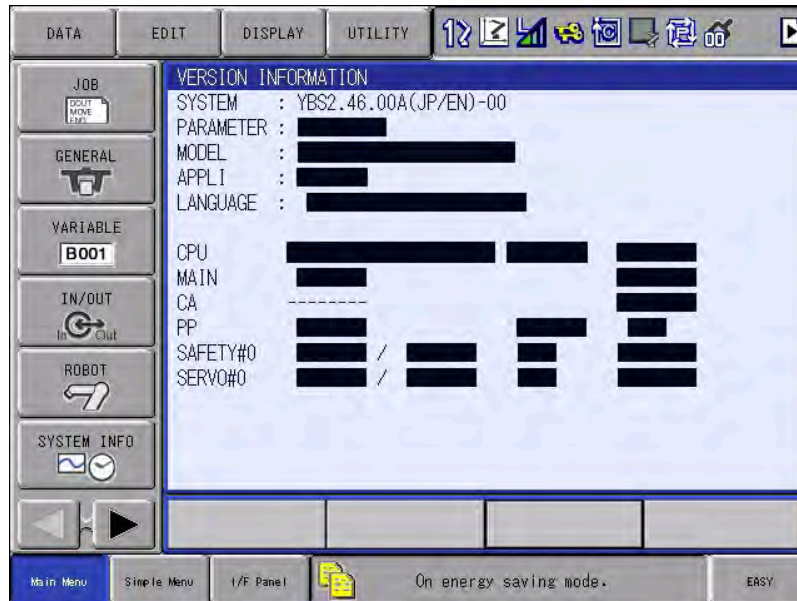

**Important:** Before upgrading, take a backup of your controller.

4 On the Yaskawa teach pendant, follow these steps to view Yaskawa options:

a Select **SYSTEM INFO**, then select **CONTROLLER INFORMATION**.



b Use the down arrow on the keypad to scroll down until you find **IO MODULE**.

- For the YRC1000, look for the **ASF01** board.

If you don't see the FSU IO Module for your controller, contact your Yaskawa Motoman distributor to upgrade.

**Tip:** Hold **SHIFT** and press the up/down arrows to scroll quicker.

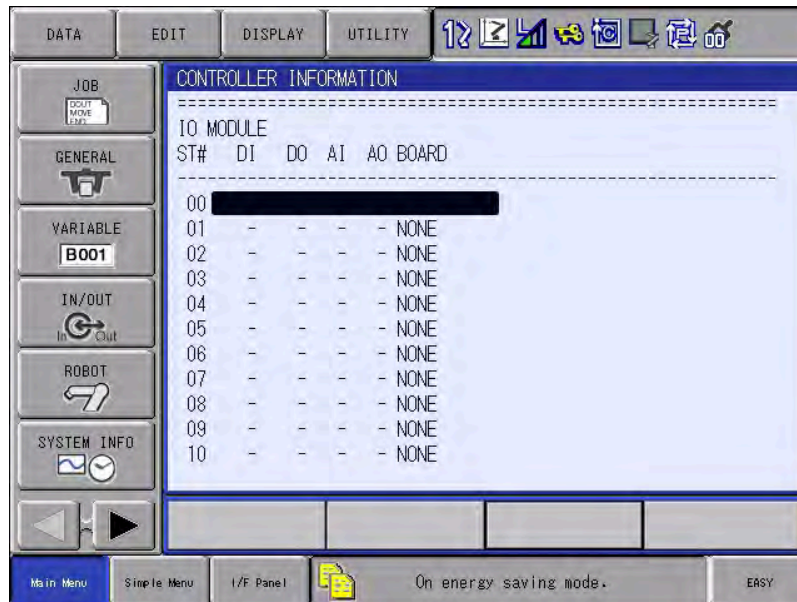

**c** Use the down arrow on the keypad to scroll down until you find **OPTION FUNCTION**. Keep scrolling to look for **046 MotoPlus FUNC.** and **049 Functional Safety** in the list of options. If you don't see these options in the list, contact your Yaskawa Motoman distributor to upgrade.

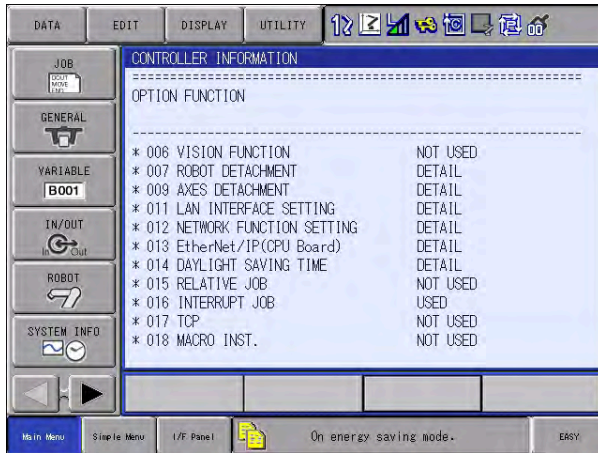

# BACK UP AND UPGRADE THE ROBOT CONTROLLER

Save a backup of your Yaskawa controller software settings before you make any changes. Yaskawa controllers can save backups to either a USB flash drive or SD card. Refer to Yaskawa documentation for more information.

- 1 Insert a USB drive into the back of the Yaskawa pendant.

**Note:** Use an empty USB drive (FAT-32 file format) with at least **2 GB** of storage.



- 2 Turn the pendant key to TEACH mode.



3 In the Main Menu, select **EX.MEMORY**, then select **SAVE**.

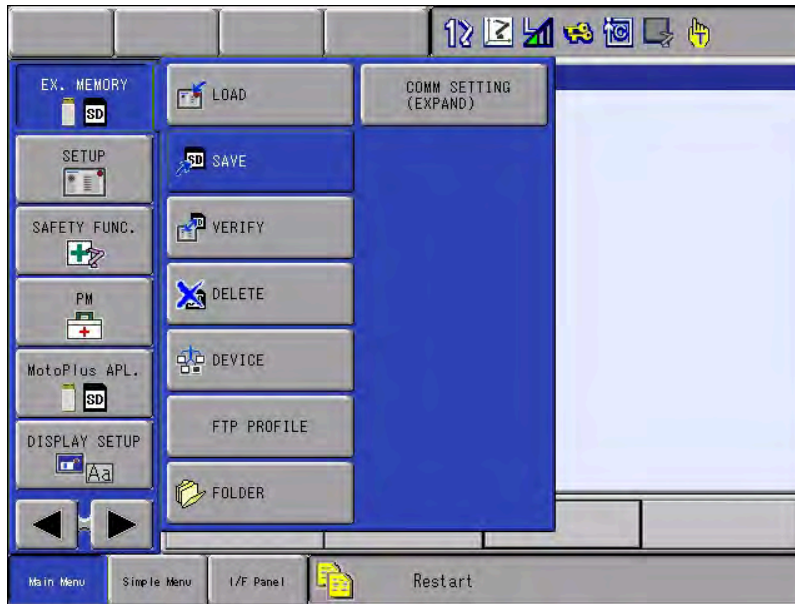

4 Scroll down to highlight **SYSTEM BACKUP(CMOS.BIN)**, then press **SELECT**.

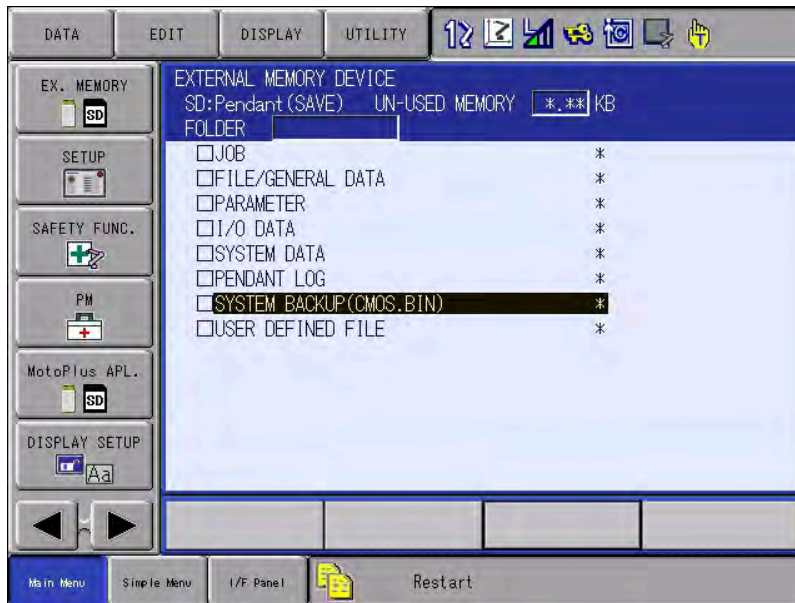

- 5 At the **Save?** prompt, tap **YES** on the screen.

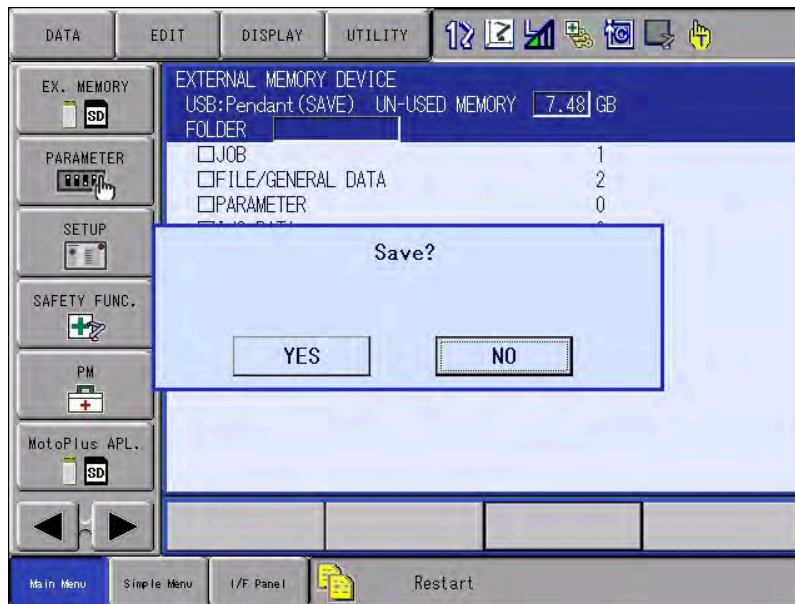

- 6 The bottom notification bar reads **Saving system backup file. Don't turn the power off.** Wait for the backup to finish.

- 7 Power off the robot controller.

- 8 Remove the USB flash drive from the pendant.

**Tip:** Keep your USB backup drive in a secure location. You can save the backup files from the USB onto a workstation.



# CONNECTING THE READY PENDANT

The READY pendant includes these safety outputs:

1. Key Switch (Robot Operation Mode)
2. Three-Position Enabling Switch
3. Emergency Stop Button



**Electric Shock Warning:** Disconnect all components from power sources before attempting this installation.

1 If you are using a Forge/Ctrl, prepare the READY pendant Junction Box:



- a Connect a Cat5e STP Ethernet cable from the junction box Ethernet port (1) into a **LAN** port (5) on the Forge/Ctrl.

---

- b Connect the 8-Pin power cable (4) from the junction box into one of the **Module** ports (6) on the Forge/Ctrl.

---

- c Connect the 12-Pin flying leads cable to the safety port (3) on the junction box.

---

2 If you are using a Forge/Hub, connect the 12-Pin flying leads cable to the **Safety** port on the Forge/Hub.



- 3 Remove one of the covering plates on right side or back side of the YRC1000. Make a hole on the plate for the flying leads cable to enter.

**Tip:** Install a cable gland for strain relief.



- 4 Feed the flying leads end of the M12 cable through the gland and set the plate in place. Refer to Yaskawa's *YRC1000 Instructions* for proper cable sealing and routing.

- 5 Read this information on terminal block wiring before moving on.

- a** Terminal blocks are convenient electrical connectors with ports for attaching individual wires. They make up the Safety Breakout Board.
- b** You must hold a port open while inserting a wire into it. To open a port, push straight down on the lever using a small flathead screwdriver. While applying pressure, slide a wire into the port. Once the wire is in, remove pressure to close the port. You can pull gently on the lead to make sure it's secure.

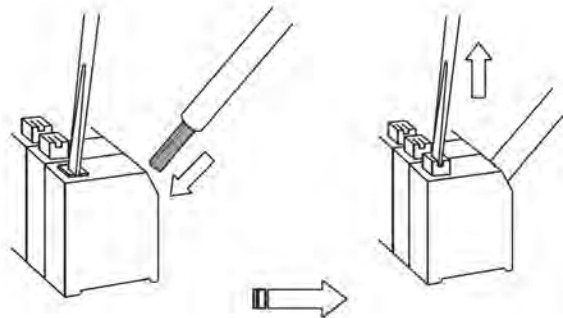

6

Connect the flying leads of the M12 cable to the Functional Safety Unit Breakout Board. Follow the wiring diagram and table below.

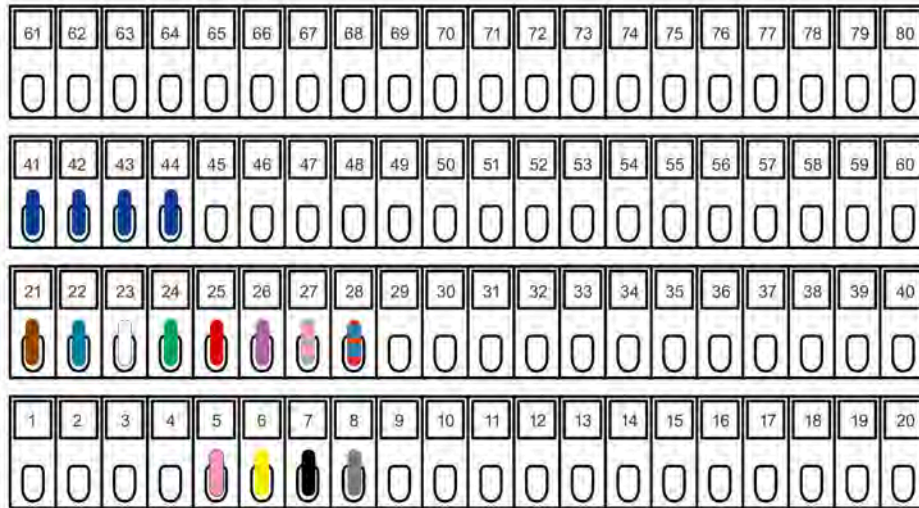

12-Pin Cable	Destination Terminal	Function
Brown	FSU Breakout - 21	Three-Position Enabling Switch Circuit 1
Blue	FSU Breakout - 22	Three-Position Enabling Switch Circuit 1
White	FSU Breakout - 23	Three-Position Enabling Switch Circuit 2
Green	FSU Breakout - 24	Three-Position Enabling Switch Circuit 2
Pink	FSU Breakout - 5	Emergency Stop Circuit 1
Yellow	FSU Breakout - 6	Emergency Stop Circuit 1
Black	FSU Breakout - 7	Emergency Stop Circuit 2
Grey	FSU Breakout - 8	Emergency Stop Circuit 2
Red	FSU Breakout - 25	Key Switch Circuit 1
Violet	FSU Breakout - 26	Key Switch Circuit 1
Grey/Pink	FSU Breakout - 27	Key Switch Circuit 2
Red/Blue	FSU Breakout - 28	Key Switch Circuit 2
X	FSU Breakout - 41	Jumpers/Safety Fencing
X	FSU Breakout - 42	Jumpers/Safety Fencing
X	FSU Breakout - 43	Jumpers/Safety Fencing
X	FSU Breakout - 44	Jumpers/Safety Fencing

**7** If you are using external safety fencing:

**a** Connect fence channel 1 to connector pins 41 and 42

**b** Connect fence channel 2 to connector pins 43 and 44

**8** If you are not using external safety fencing:

**a** Bridge pins 41 and 42 with a jumper wire.

---

**b** Bridge pins 43 and 44 with a jumper wire.

---

# CONNECTING TO THE IPC

Forge/OS must communicate with the Yaskawa controller. This section will help you connect the IPC device and YRC1000 using a Cat5e STP Ethernet cable.

- 1 Find a Cat5e STP Ethernet cable long enough to reach from the IPC to inside the Yaskawa controller.

- 2 Remove another cable covering plate. Make a hole on the plate for the Ethernet cable.

*Tip: Install a cable gland for strain relief.*



- 3 Feed the Ethernet cable through the plate. Refer to Yaskawa's *YRC1000 Instructions* for proper cable sealing and routing.

- 4 Mount the plate in place.

- 5 Connect one end of the Ethernet cable to the LAN port labeled "CN106 (LAN2)" on the CPU Unit inside the robot controller near the left wall of the enclosure.

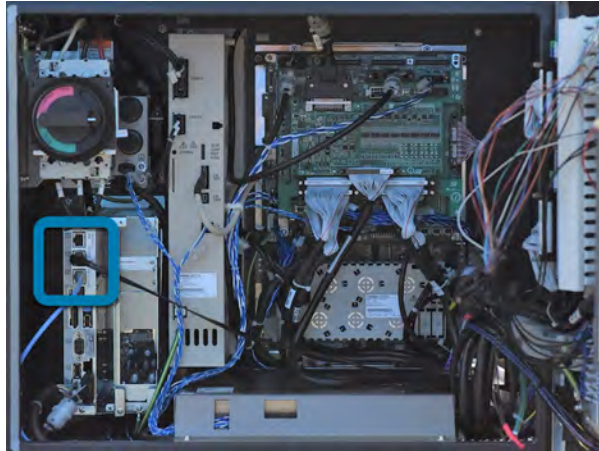

- 6 Plug the other end of the Ethernet cable into a LAN port on the IPC or on a network switch you connect to the IPC.

- 7 Zip-tie the added cables along the base of the robot controller. Zip-tie the Functional Safety I/O Cable along the base of the door.

**Important:** Make sure the robot controller door can shut without pinching or bending any cables.

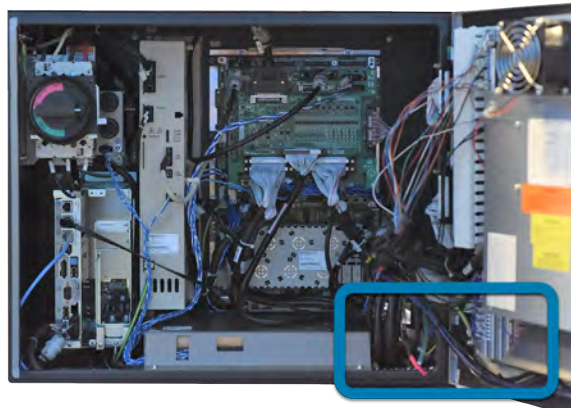

- 8 Close the controller and use a flat-blade screwdriver to turn the door lock counterclockwise.



# SIGNING IN TO FORGE/OS

Follow these steps to pair the READY pendant with the IPC and sign in to Forge/OS 5.

- 1 If you need to install Forge/OS 5 on your IPC, stop here and follow all the steps in [Appendix A](#), then come back to these steps.

*Tip: Forge/OS 5 is installed on all Forge/Ctrls and Forge/Hubs shipped after June 1, 2021.*

- 2 The READY pendant automatically finds and pairs with the IPC. The three LEDs on the screen help you track the status:

- **Pendant Network Connection:** This condition is satisfied when the READY pendant has a valid network connection (i.e., the Ethernet cable is plugged in).
- **Forge/OS IPC Detected:** This condition is satisfied when the READY pendant detects a Forge/OS IPC on the network.
- **Forge/OS IPC Paired:** This condition is satisfied when the READY pendant successfully pairs with the IPC. If pairing fails, it is automatically retried indefinitely.

When a condition is not satisfied, the LED is red. When a condition is in progress of becoming satisfied, a spinner around a READY logo appears to the right of the text. When a condition becomes satisfied, the LED turns green.

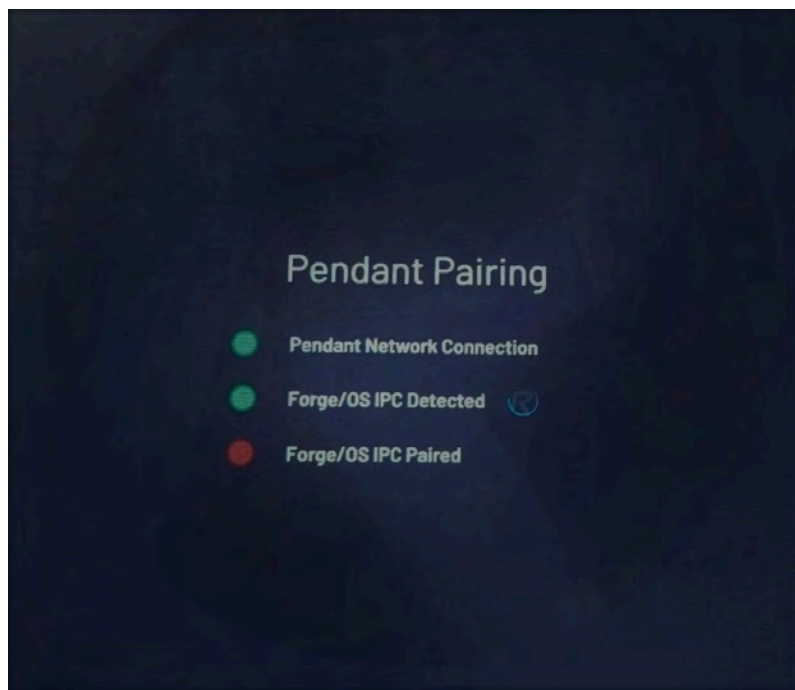

The UI shows the real-time state of each step. For example, if the pendant loses its network connection during

pairing, all steps become undone.

If the READY pendant spends more than 60 seconds on any step, troubleshooting text displays. Common things to check are if the READY pendant network cable is plugged in, if the IPC is powered on, if the READY pendant and IPC are connected to the same network, and if there's only one READY pendant and one IPC on that network.

3 Tap **Admin** and sign in. The default Admin password is "forgeadmin".

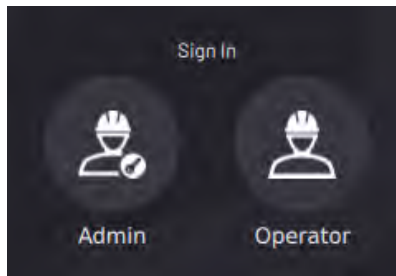

4 If Forge/OS is inactive, it opens the Settings app and prevents you from opening other apps. If you see the screen below, follow [Activating Forge/OS with a License Code](#) in Appendix A.

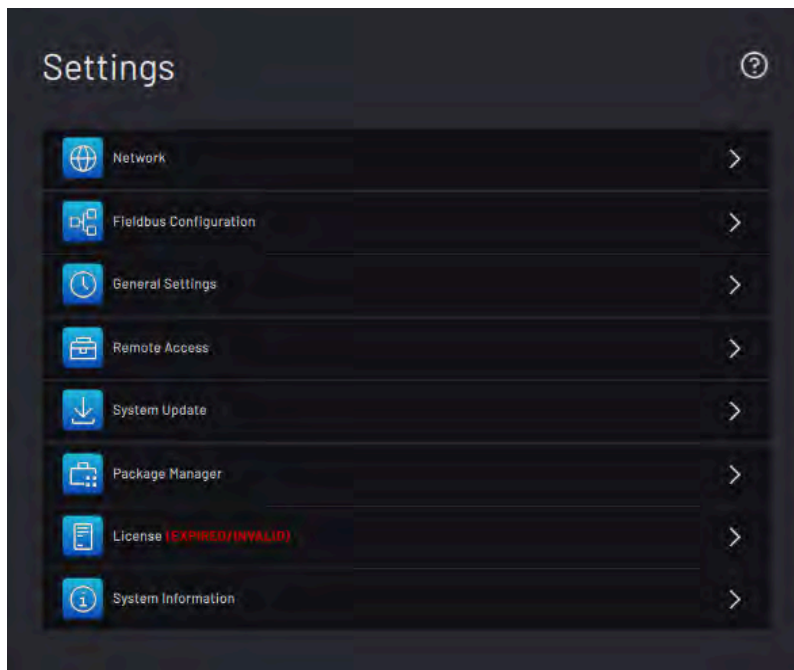

5 With Forge/OS active, move on to the next section.

# POWERING ON

- 1 Reconnect the Yaskawa controller to a power source and turn it on.



- 2 Plug your IPC power cable into a power outlet.

- 3 Power on your IPC and other devices.

**Note:** If you are using a Forge/Ctrl, turn the Power Disconnect Switch to **ON**. Then press the green power button on the opposite side of the Forge/Ctrl.

- 4 If there are issues, power off each device, disconnect from power supplies, and check your wiring.

# GETTING ROBOT FILES FROM FORGE/OS

In this section, you add the robot in Forge/OS and copy configuration files to the robot controller.

- 1 In the **Admin** role, open the **Device Configuration** app.

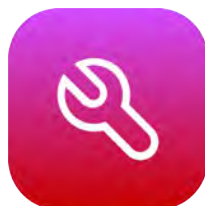

- 2 Tap **New +** to open the Device Library.

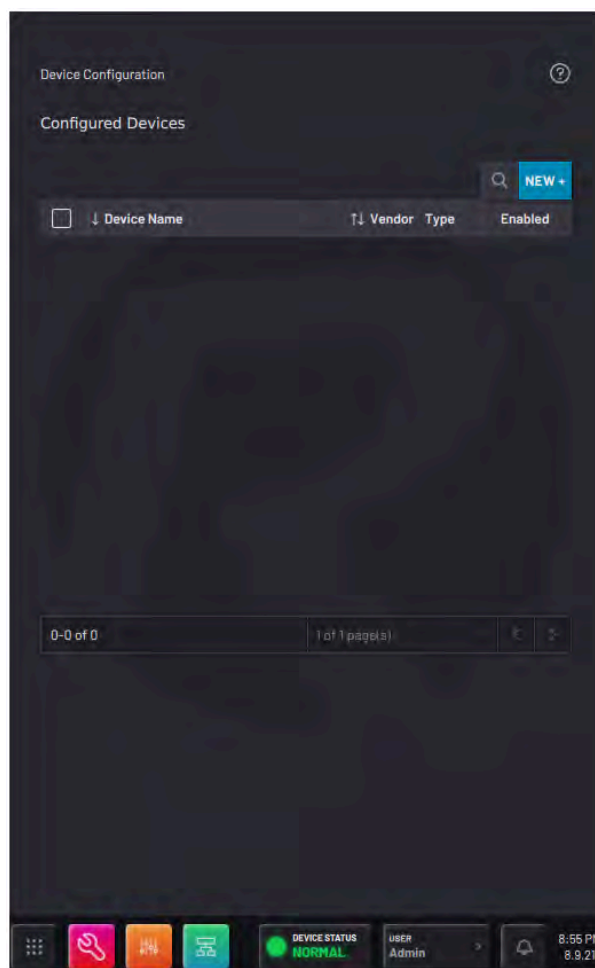

3

In the Device Library list, select **Yaskawa Motoman industrial robot**. Then tap **NEXT**.

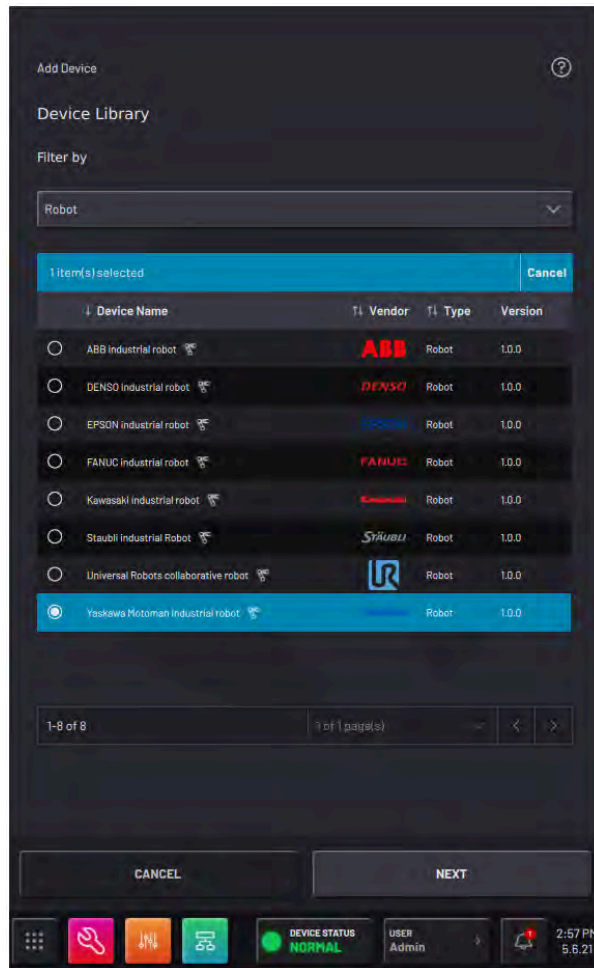

- 4 Select the robot **Controller Model**, then select the **Robot Model**. You can fill in the other information later.

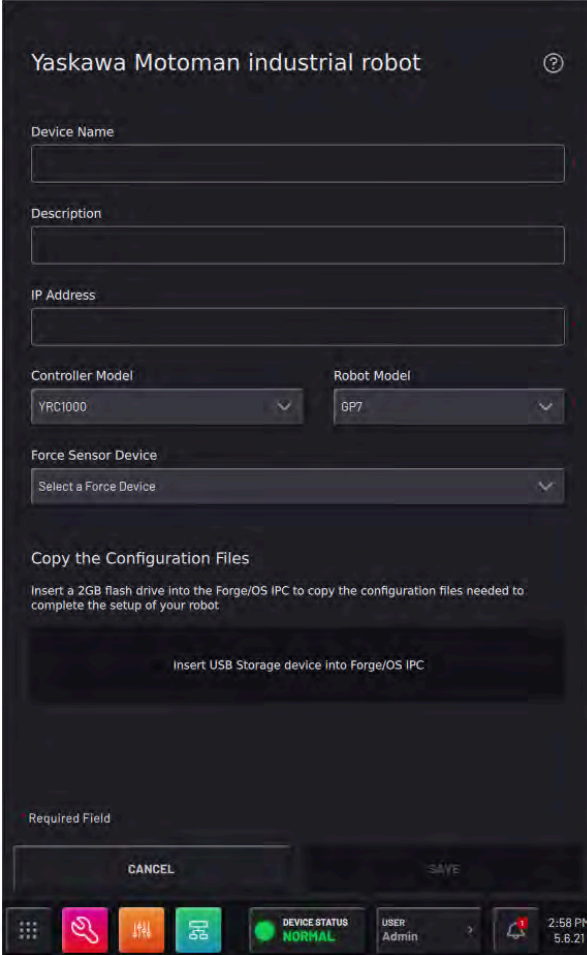

Yaskawa Motoman industrial robot

Device Name

Description

IP Address

Controller Model  
YRC1000

Robot Model  
GP7

Force Sensor Device  
Select a Force Device

Copy the Configuration Files

Insert a 2GB flash drive into the Forge/OS IPC to copy the configuration files needed to complete the setup of your robot.

Insert USB Storage device into Forge/OS IPC

Required Field

CANCEL SAVE

DEVICE STATUS  
NORMAL

USER  
Admin

2:58 PM  
5.6.21

- 5 Insert a USB flash drive into the IPC as instructed on the screen. Use an empty flash drive with at least 2GB of storage.

*Tip: Do not connect the USB flash drive to the **READY** pendant.*

- 6 Tap **Start Transfer** and wait for it to finish.
- 7 Remove the USB flash drive when prompted.

- 8 Insert the USB drive into the USB port on the back of the Yaskawa pendant.



# CHANGING ROBOT SETTINGS TO PREPARE FOR FORGE/OS

In this section, you'll change some robot controller settings to enable Safety I/O Expansion Board and communication with Forge/OS. Follow these steps if this is the first time setting up Forge/OS with your Yaskawa controller, or if your controller has been factory reset.

- 1 On the Yaskawa pendant, turn the key to TEACH position.



- 2 If there are active alarms on the Yaskawa pendant, tap the **RESET** button at the bottom-right corner of the screen to clear them.

**Note:** You may ignore minor alarms if they can't be cleared right away. If there is a major alarm, you need to resolve it before moving on. When you press **RESET**, the Yaskawa pendant warns you if there is a major alarm.



**3** Change the security mode to Safety Mode:

**a** From the Main Menu, select **SYSTEM INFO**, then **SECURITY**.



**b** Tap the field next to **MODE** or press **SELECT**.

**c** Scroll to **SAFETY MODE** from the dropdown list and press the **SELECT** button on the pendant keypad.

**d** Enter the Safety Mode password and press **ENTER**.

*Tip: For **non-collaborative** robots, the default Safety Mode password is "5555 5555 5555 5555"*

**e** If successful, the visible mode changes to **SAFETY MODE**. If you enter the wrong password, you get an **Error 1030** message. Try again.

4 Set parameters S2C0701, S2C0425, S2C0430, S2C1419, and S2C1586:

a From the Main Menu, find and select **PARAMETER**. Select the **S2C** option.

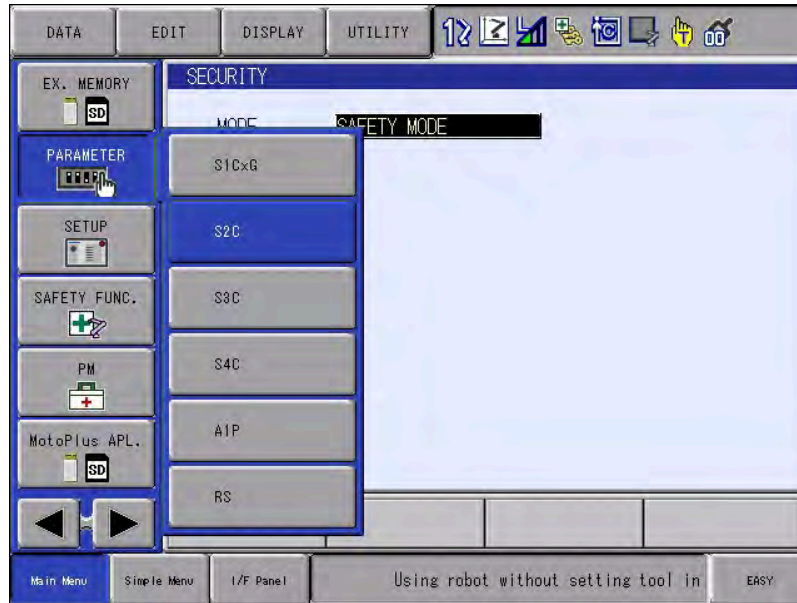

b To "Jump to" parameter **S2C0701**, you can highlight a parameter name in the first column and press the **SELECT** button on the keypad. Then enter the number 0701 and press **ENTER**.

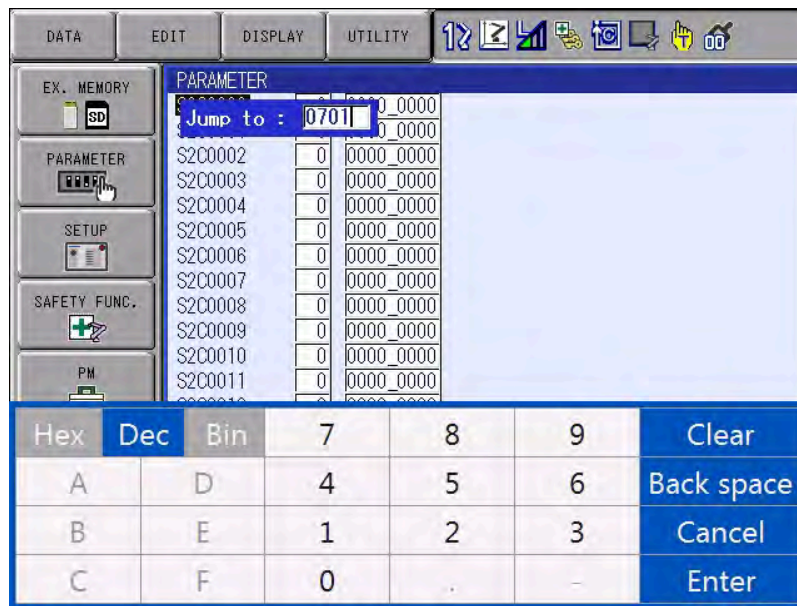

- c** Set **S2C0701** to **1**. Highlight the box to the right of the parameter name and press **SELECT**, then enter **1** and press **ENTER**.

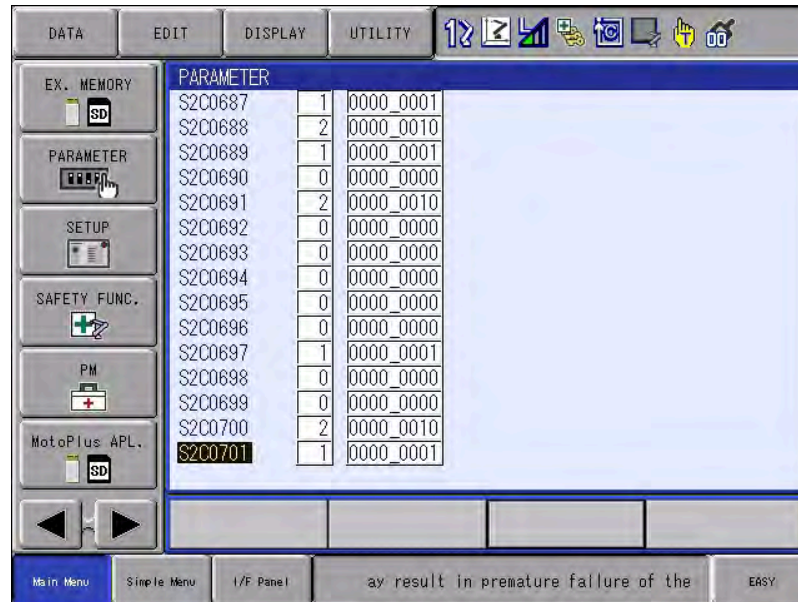

- d** Repeat the process above to set the parameter **S2C0425** to **0**.
- e** Repeat the process above to set the parameter **S2C0430** to **4**.
- f** Repeat the process above to set the parameter **S2C1419** to **1**.
- g** Repeat the process above to set the parameter **S2C1586** to **1**.

**5** Set parameters S4C0287 - S4C0295.

**a** From the **PARAMETER** menu, select **S4C**.

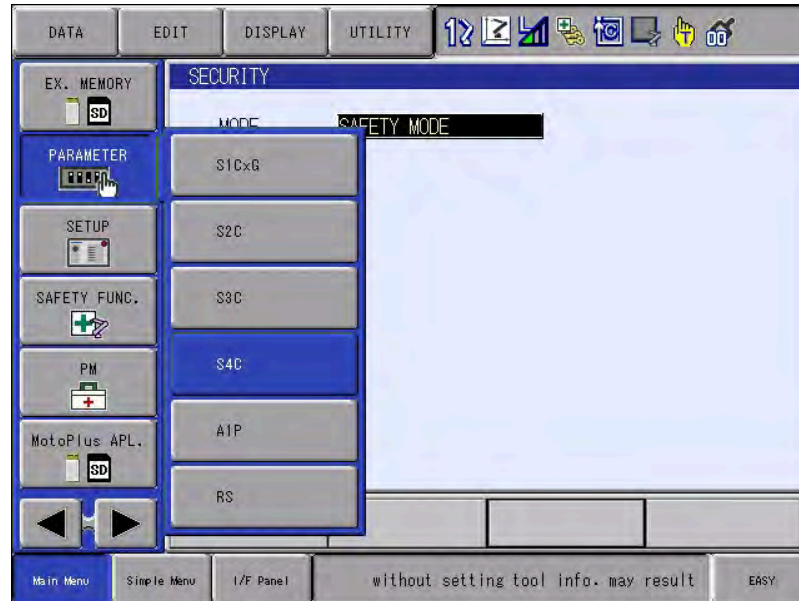

**b** Set parameter **S4C0287** to **511**.

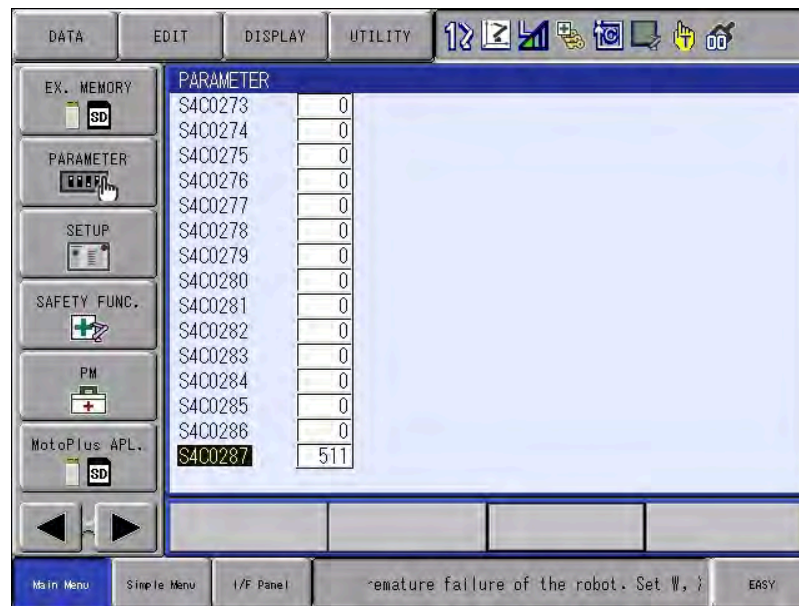

**c** Set parameters **S4C0288 - S4C0295** to **0**.

**6** (Optional): If your controller has the **SETUP > SPEED OVERRIDE SETTING** menu, you can check if the parameters were correctly set:

**a** Verify that **Setting Method = I/O**.

- b** Verify that **Continuous Cycle Operation = Valid**.

---

- c** Verify that **Automatic Setting = Invalid**.

---

- d** Verify that **Initial Speed Ratio = 100%**.

---

- e** Verify that **GP. Input = 511**.

---

- f** Verify that all **Speed Ratio** parameters = **0%**.

---

**7** Follow these steps to disable the CRC check function.

- a** From the **MAIN MENU**, select **SETUP**, then choose **FUNCTION ENABLE**.



- b** Scroll down to highlight the field next to **SAVE DATA CRC CHECK FUNC. (FSU)** and press the **SELECT** button to set it to **INVALID**.

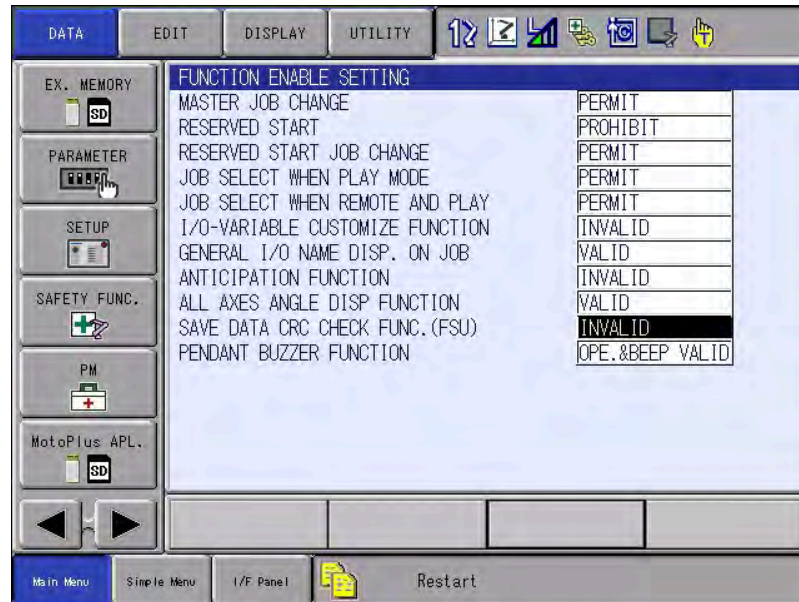

- 8** Power off the Yaskawa controller and wait 10 seconds.
- 9** Press and hold the **MAIN MENU** button while powering on the robot controller to enter Maintenance Mode. Release **MAIN MENU** when you hear the teach pendant beep.
- 10** Change the security mode to Safety Mode:
  - a** From the Main Menu, select **SYSTEM**, then **SECURITY**.
  - b** Tap the field next to **MODE** or press **SELECT**.
  - c** Scroll to **SAFETY MODE** from the dropdown list and press the **SELECT** button on the pendant keypad.
  - d** Enter the Safety Mode password and press **ENTER**.
  - e** If successful, the visible mode changes to **SAFETY MODE**. If you enter the wrong password, you get an **Error 1030** message. Try again.

11 From the Main Menu, select **SYSTEM**, then select **SETUP**.

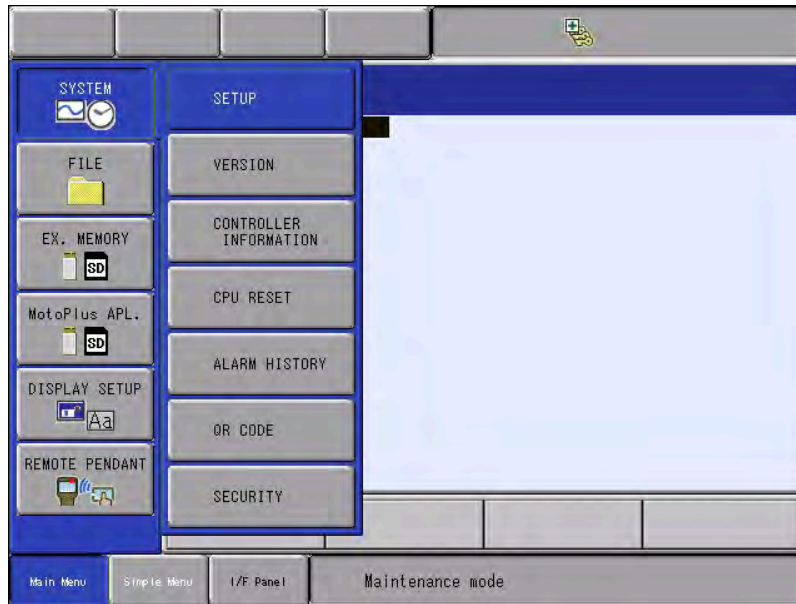

a Highlight **OPTION FUNCTION** and press the **SELECT** button.



**b** Highlight **DETAIL** next to **LAN INTERFACE SETTING** and press the **SELECT** button.

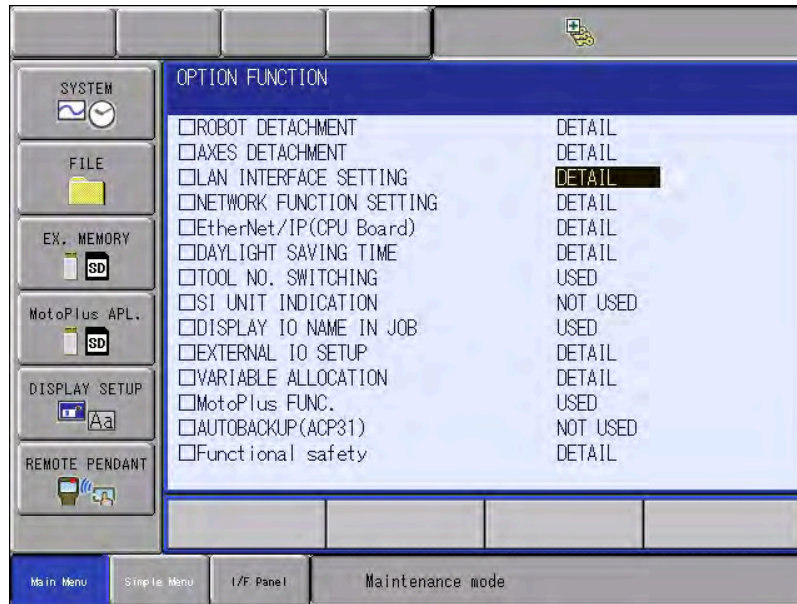

**c** Set the **IP ADDRESS SETTING** to **MANUAL SETTING**.

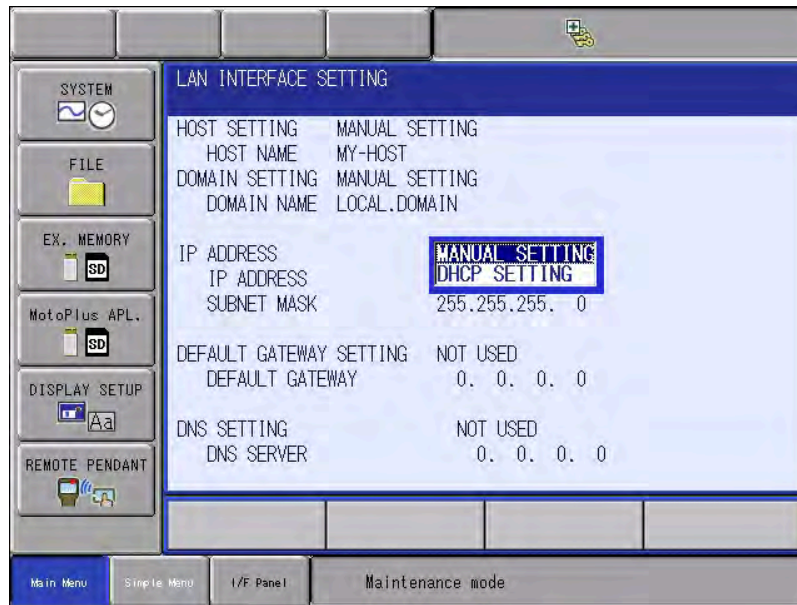

**d**

**e** Set the IP Address and Subnet Mask according to the READY IPC you have:

- *Forge/Ctrl*: set the **IP Address** to **172.16.255.251** and set the **Subnet Mask** to **255.255.255.0**.
- *Forge/Hub*: set the **IP Address** to **192.168.1.20** and set the **Subnet Mask** to **255.255.255.0**.

**f** Set both the **DEFAULT GATEWAY SETTING** and **DNS SETTING** to **NOT USED**.



**g** Press **ENTER** to save the settings. At the **Modify?** prompt tap **YES**.

**h** Back in the OPTION FUNCTION menu, highlight the field next to **MOTOMAN DRIVER** and make sure it's set to **USED**. If not, press the **SELECT** button.

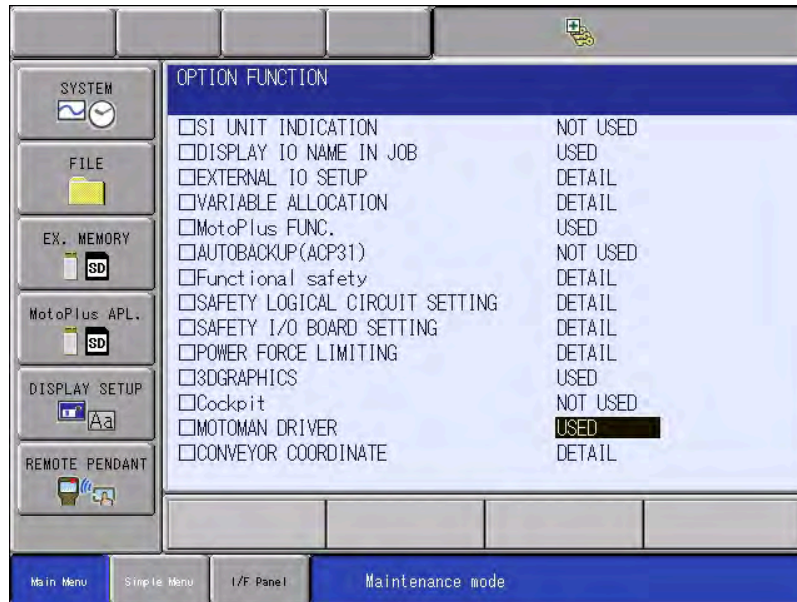

**i** At the **Modify?** prompt tap **YES**.

**j** Back in the OPTION FUNCTION menu, highlight the field next to **MotoPlus FUNC** and set it to **USED**.

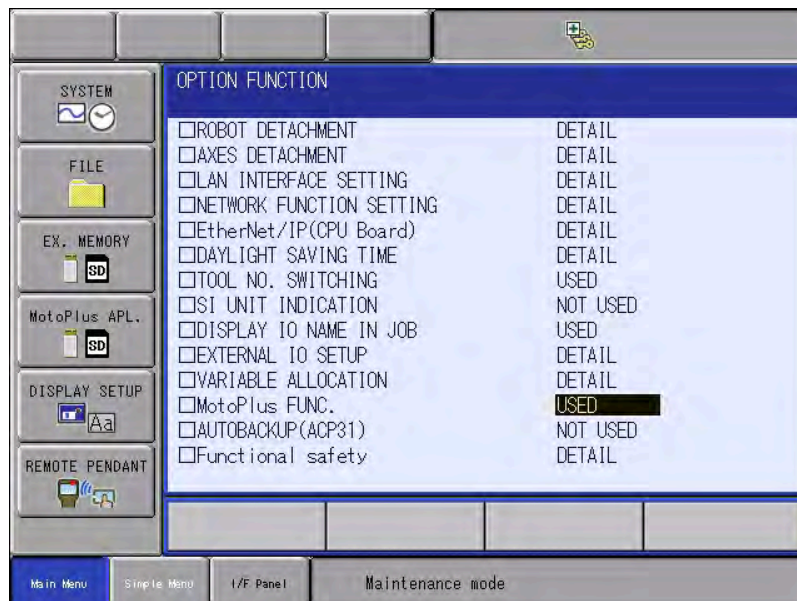

**k** At the **Modify?** prompt tap **YES**.

**l** At the **Initialize related files? SRAMDRV.DTA** prompt tap **YES**.

**m** Select the field next to **SAFETY I/O BOARD SETTING**.



**n** Select the **ASF02** board.

**o** Press the **ENTER** button on the keypad to apply this choice.

**p** At the **Modify?** prompt, tap **YES**.

12 Save settings to the Safety I/O board. From the Main Menu, tap **FILE**, then tap **INITIALIZE**.

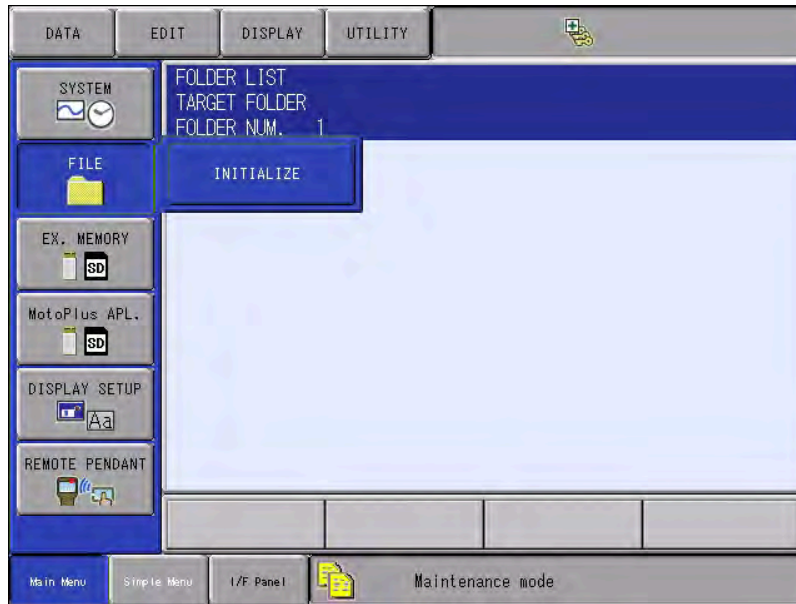

a Highlight **Safety Board FLASH Reset** and press the **SELECT** button.

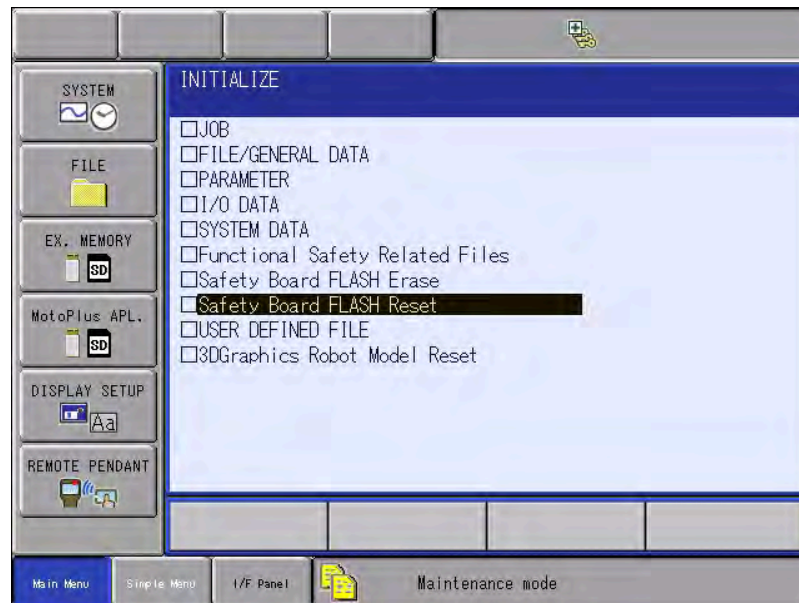

- b** At the **Reset?** prompt tap **YES**. Wait for the flash reset to complete and the pendant to beep. This process takes up to 60 seconds to complete. The arrow buttons are disabled until the reset completes.

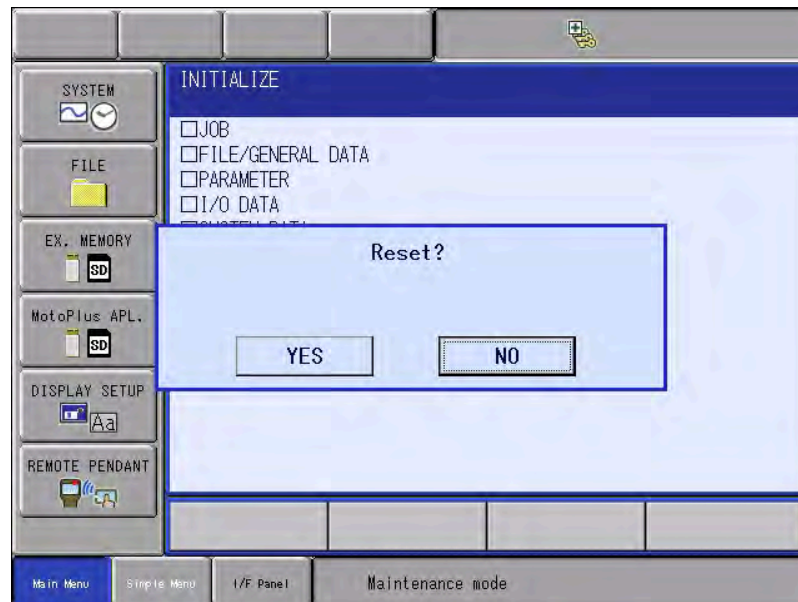

## TRANSFERRING CONFIGURATION FILES

This section assumes that your Yaskawa pendant is still booted in Maintenance Mode and that you have selected the Safety Security Mode.

- 1** Follow these steps to load the Forge MotoPlus APL.

- a** From the Main Menu, tap **MotoPlus APL**, then tap **FOLDER** to select the folder to load files from.
- b** Tap the **forge-os** folder to open it, then tap to open the **yaskawa** folder. At the top of the screen, the **TARGET FOLDER** should be **yaskawa**.

**c** From the Main Menu, tap **MotoPlus APL**, then tap **LOAD (USER APPLICATION)**.

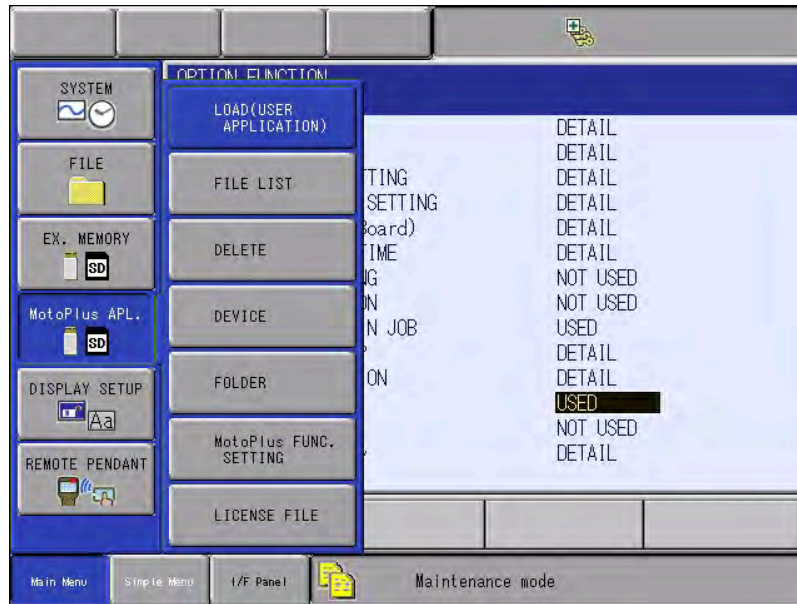

**d** Highlight the **MotoPlusYRC1....out** file on the USB drive and press the **SELECT** button.

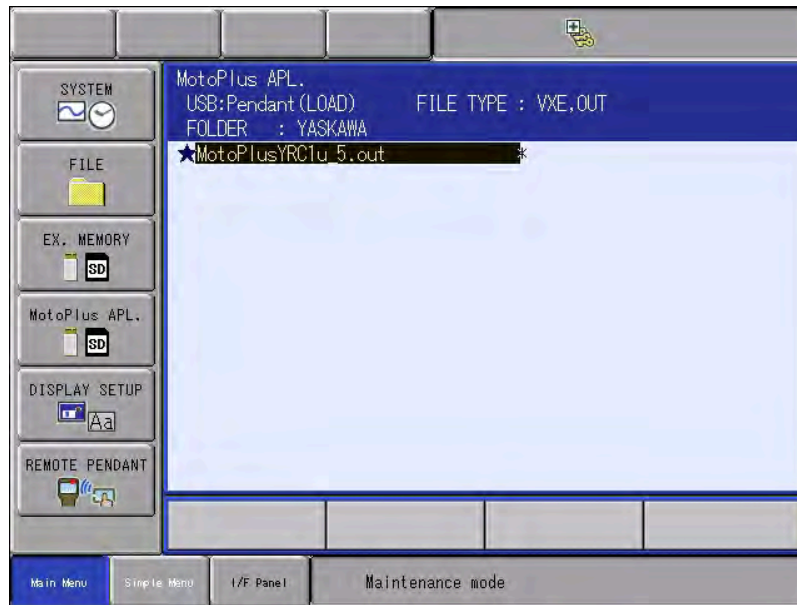

**e** Verify that a small black star icon appears to the left of the file name and press the **ENTER** button on the pendant keypad.

**f** At the **Load** prompt tap YES. If asked to overwrite an existing file, select **YES**.

**2** Power off the Yaskawa controller and wait 10 seconds.

**3** Power up the Yaskawa controller (not in Maintenance Mode).

4 An alarm may appear up to two minutes after restarting: **ALARM 8001[10]; Speed FB enabled, reboot now.** Do **NOT** reboot now, tap the **RES** button on the screen and continue.

5 Change the security mode to Safety Mode:

- a From the Main Menu, select **SYSTEM INFO**, then **SECURITY**.
- b Tap the field next to **MODE** or press **SELECT**.
- c Scroll to **SAFETY MODE** from the dropdown list and press the **SELECT** button on the pendant keypad.
- d Enter the Safety Mode password and press **ENTER**.
- e If successful, the visible mode changes to **SAFETY MODE**. If you enter the wrong password, you get an **Error 1030** message. Try again.

6 If you have loaded Forge/OS files onto this robot controller before, make sure the correct MotoPlus application is running and no other apps are running:

a From the Main Menu, select **MotoPlus APL.**, then **MotoPlus MONITOR**.

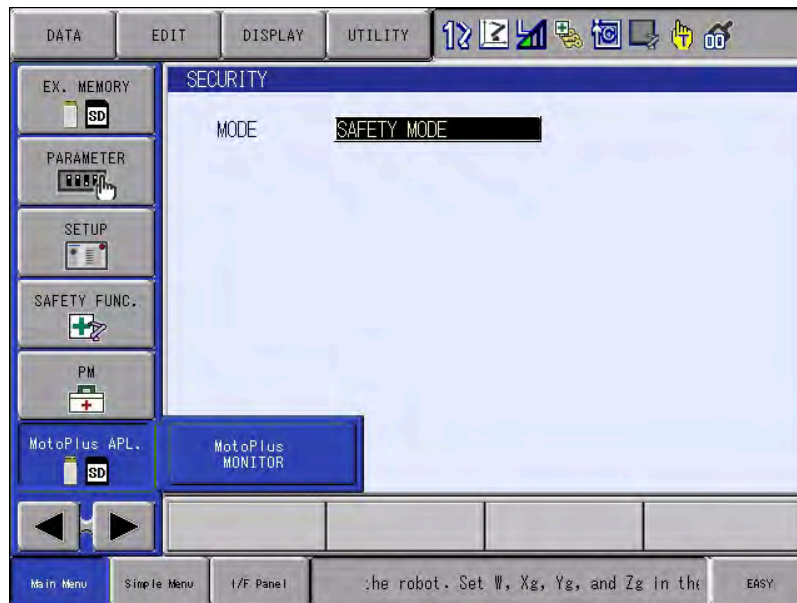

- b Tap **Application Run Flow**. Make sure the ONLY file listed under "Active Application" is **MotoPlusYRC1\_5.out**.
- c If **MotoPlusYRC1\_5.out** is in the "Inactive Application" section, highlight it and press "-> Add" to set the app as active.
- d If you see any other apps listed under "Active Application," highlight them and press "<- Remove."

- e** Press **Set Flow**, then tap Close until you are out of the Monitor.

---

- f** If you made any changes, restart the robot controller. Once the robot controller restarts, enable Safety Mode and check again to make sure the correct application is running.

---

**7** From the Main Menu, tap **EX. MEMORY** , then tap **FOLDER** to select the folder to load files from.

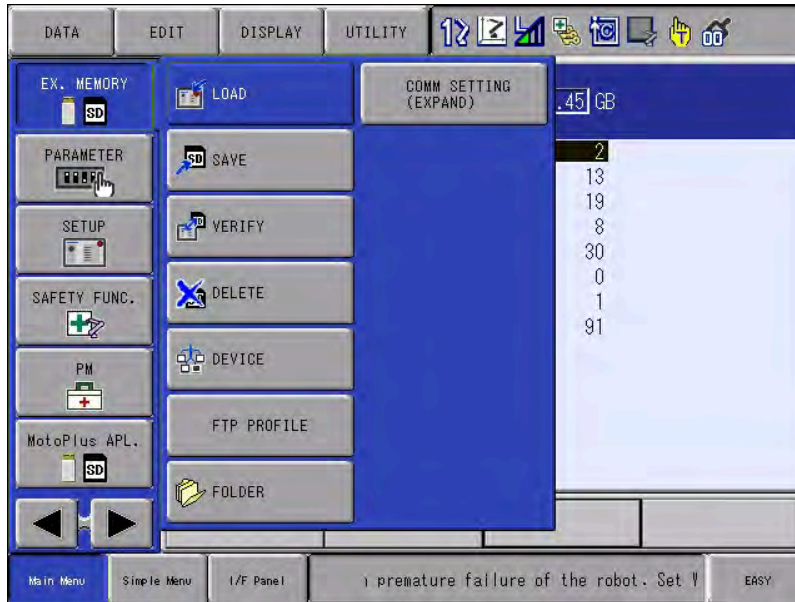

- a** Tap the **forge-os** folder to open it, then tap to open the **yaskawa** folder. At the top of the screen, the **TARGET FOLDER** should be **yaskawa**.

---

- b** From the Main Menu tap **EX. MEMORY** and then tap **LOAD**.

---

**c** Highlight **JOB** and press the **SELECT** button.



**d** Highlight each file and press the **SELECT** button on the keypad so that it is marked with a star.

**e** Press **ENTER** on the keypad.

**f** At the **Load?** prompt tap **YES**.

**g** If you get **ERROR 2040 - Defined JOB name**, you need to delete the existing "RR\_x" jobs on the robot controller. While the software is in Safety Mode and the pendant is set to Teach Mode, go to **Main Menu > JOB > SELECT JOB**. Tap the **JOB** tab in the upper left toolbar and choose **DELETE JOB**. Then select the job to delete. Delete each job that starts with "RR" then try [step 8](#) again.

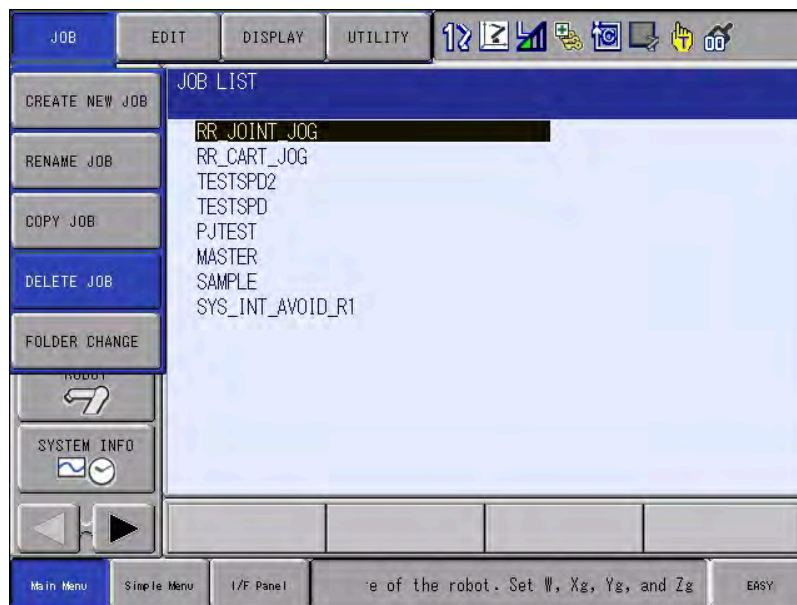



8 From the Main Menu, tap **EX. MEMORY**, then tap **LOAD**.

a Highlight **FILE/GENERAL DATA** and press the **SELECT** button.



b Select **TOOL DATA** and press the **SELECT** button on the pendant keypad.

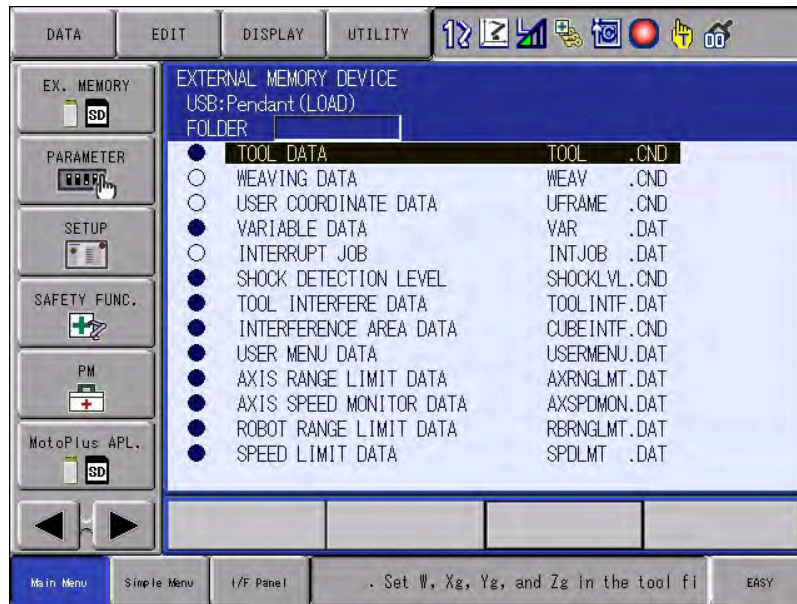

**c** Verify that the file is marked with a star.



**d** Press the **ENTER** button on the pendant keypad.

**e** At the **Load?** prompt tap **YES**.

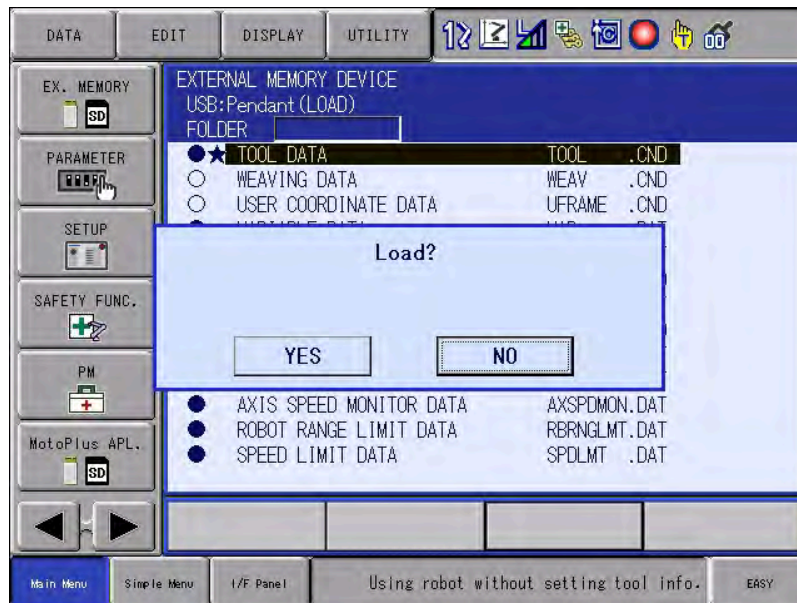

**f** The screen changes to the EXTERNAL MEMORY DEVICE screen, then to the EX. MEMORY screen.

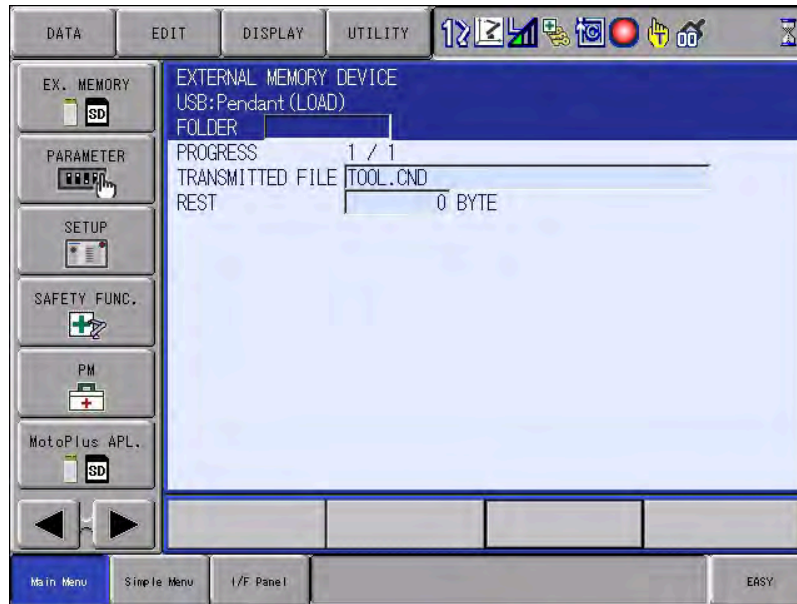

**9** From the Main Menu, tap **EX. MEMORY**, then tap **LOAD**.

**a** Highlight **FILE/GENERAL DATA** and press the **SELECT** button.

**b** Highlight the **SPEED LIMIT DATA** file and press **SELECT**. Make sure the file is marked with a star.



**c** Press **ENTER**.

**d** At the **Load?** prompt tap **YES**.

**10** From the Main Menu, tap **SAFETY FUNC.**, then choose **SPEED LIMIT**.

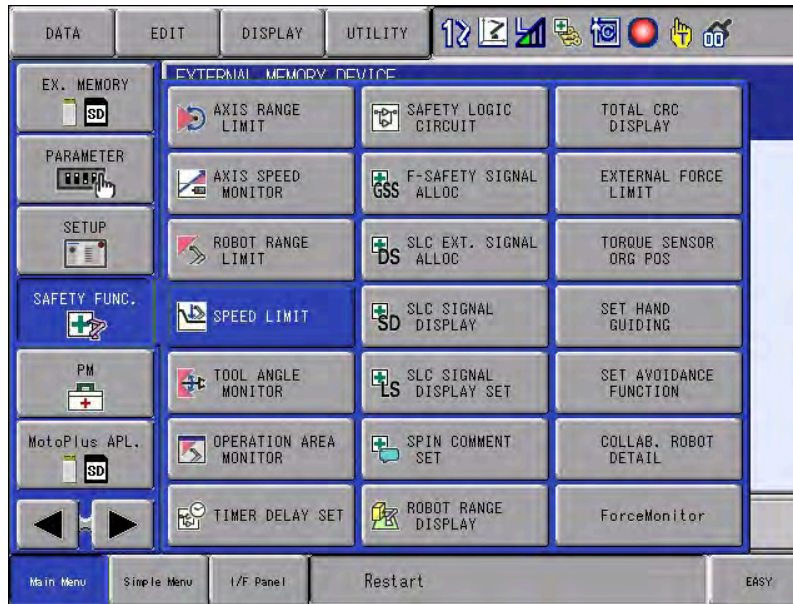

**a** Highlight **2** in the File column and press the **SELECT** button.

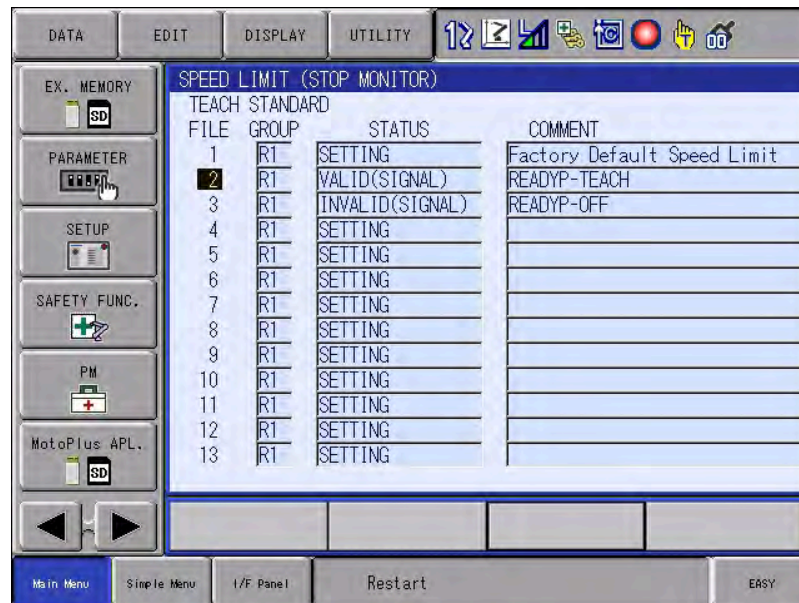

**b** Select the field next to **FILE VALID COND** and select **SIGNAL (2)** and press the **SELECT** button.

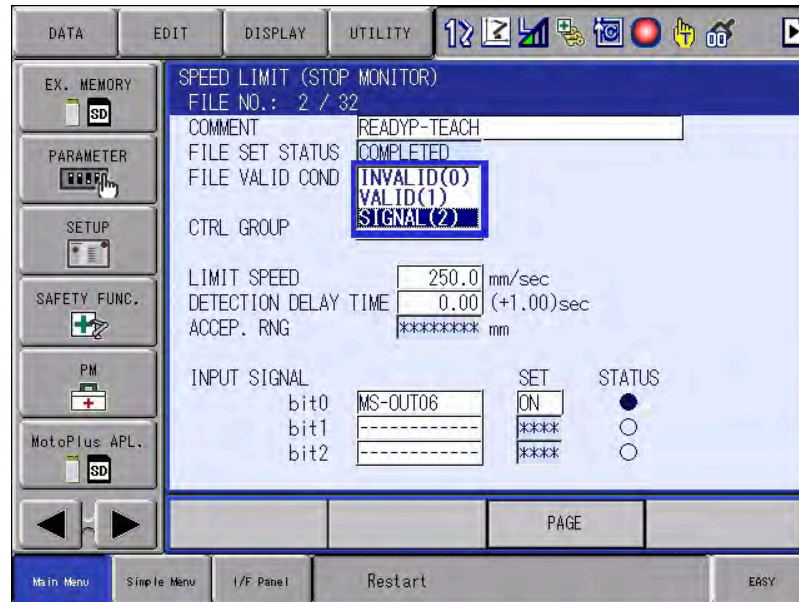

**c** Tap the **REARBACK** button on the screen.

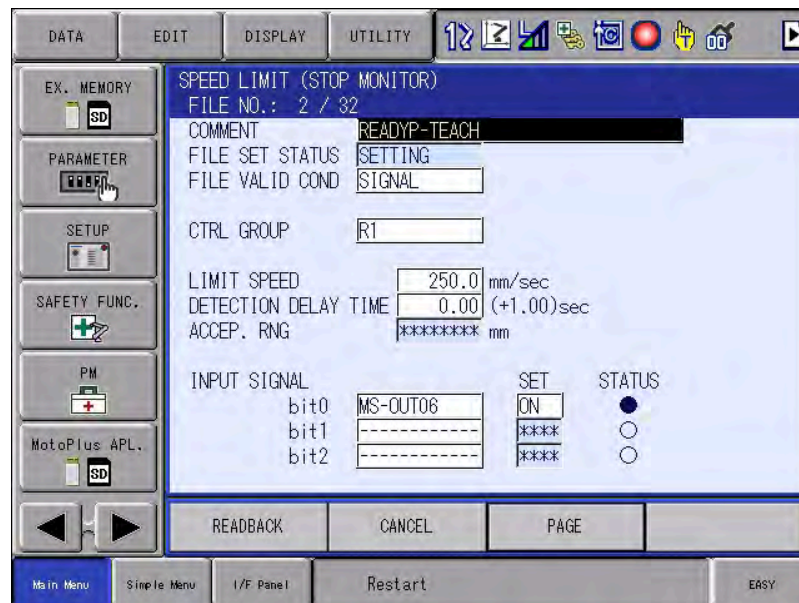

**d** Tap the **WRITE** button on the screen.

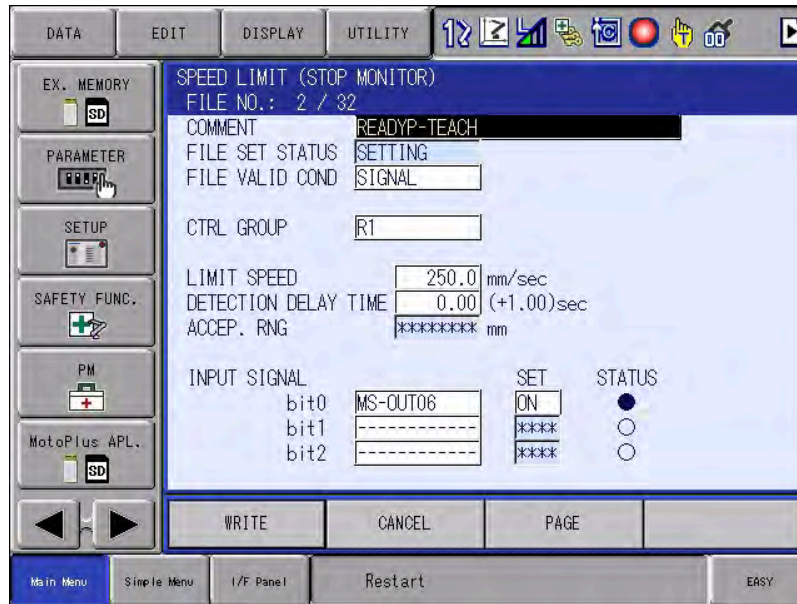

**e** At the **Update the file?** prompt tap **YES**.



**11** Repeat all sub-steps in the previous step for **3** in the File column (**READYP-OFF**). The limit and input signal are different for **READYP-OFF**. This is normal.

12 From the Main Menu, tap **EX. MEMORY**, then tap **LOAD**.

a Highlight **I/O DATA** and press the **SELECT** button.

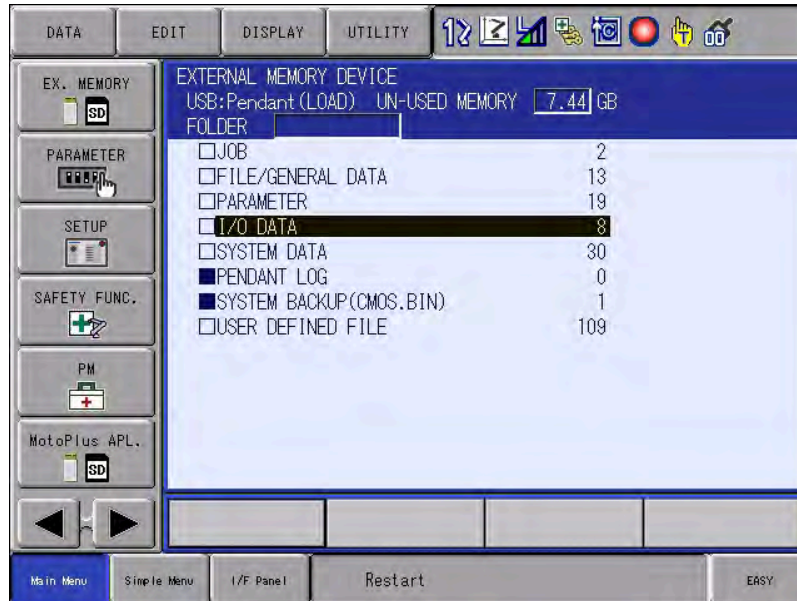

b Highlight and press the **SELECT** button on **C.IO PRGM (CIOPRG.LST)** and **YSF LOGIC FILE (YSFLOGIC.DAT)**.

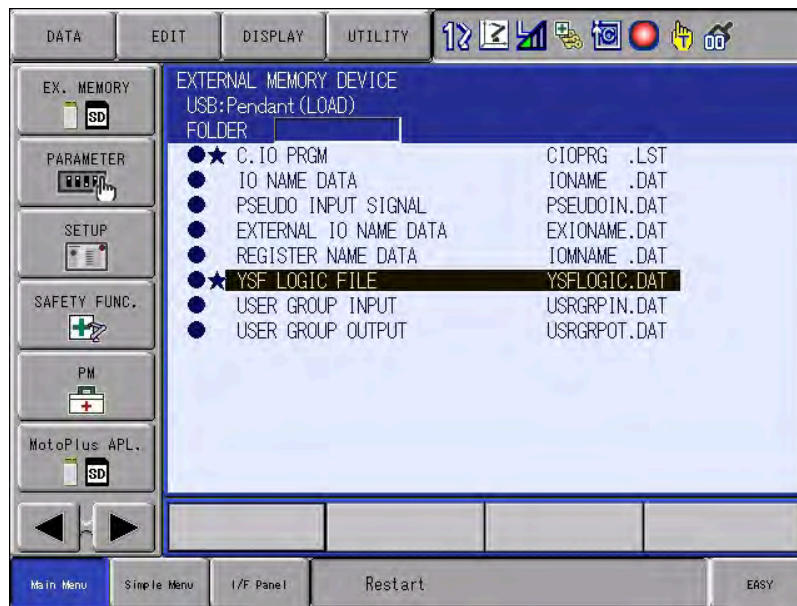

c Press the **ENTER** button on the pendant keypad.

d At the **Load?** prompt, tap **YES**.

**13** From the Main Menu, tap **SAFETY FUNC.**, then tap **SAFETY LOGIC CIRCUIT** .

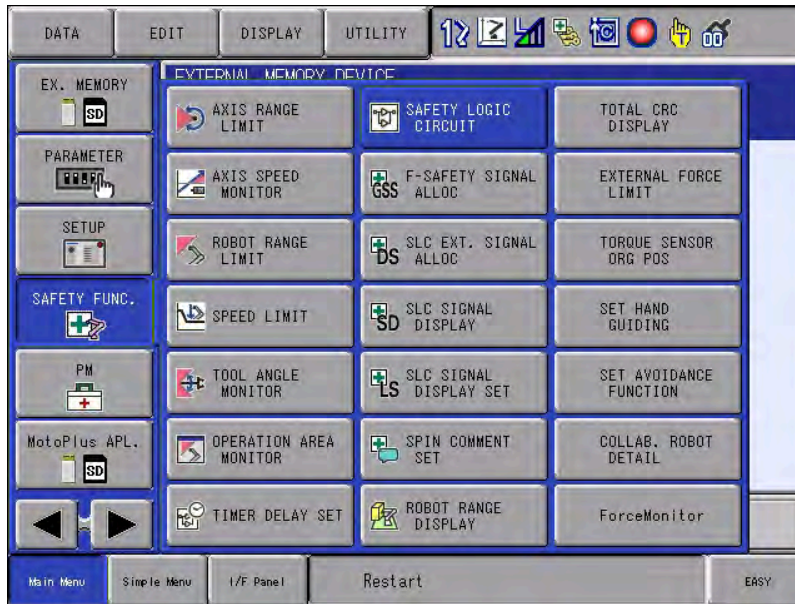

**a** Tap the **WRITE** button on the bottom of screen.

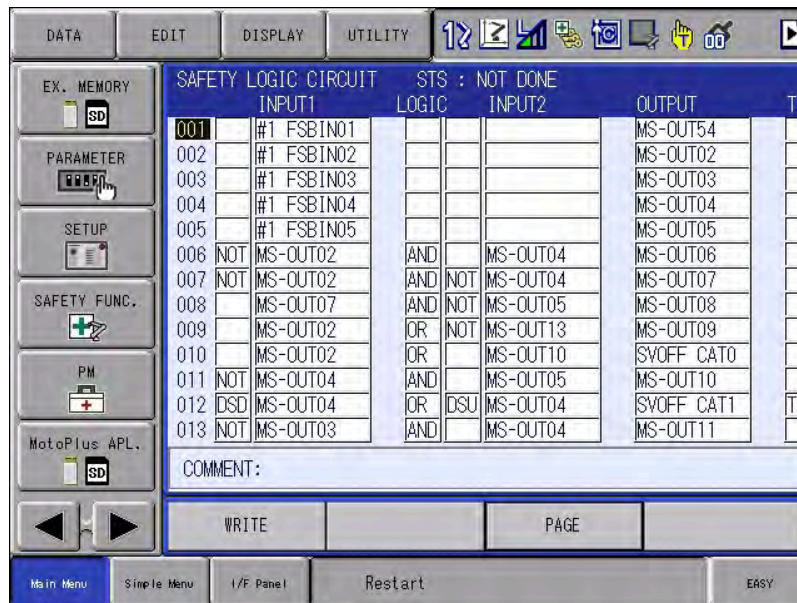

**b** Tap the **CONFIRM** button on the bottom of screen.

**c** At the **Update the file?** prompt tap **YES**.

**14** Power off the Yaskawa controller and wait 10 seconds.

**15** Press and hold the **MAIN MENU** button while powering up the Yaskawa controller to enter Maintenance Mode. Release **MAIN MENU** when you hear the teach pendant beep.



16 Change the security mode to Safety Mode:

- a From the Main Menu, select **SYSTEM**, then **SECURITY**.
- b Tap the field next to **MODE** or press **SELECT**.
- c Scroll to **SAFETY MODE** from the dropdown list and press the **SELECT** button on the pendant keypad.
- d Enter the Safety Mode password and press **ENTER**.
- e If successful, the visible mode changes to **SAFETY MODE**. If you enter the wrong password, you get an **Error 1030** message. Try again.

**17** Save changes to the Safety I/O board. From the Main Menu tap **FILE** and then tap **INITIALIZE**.

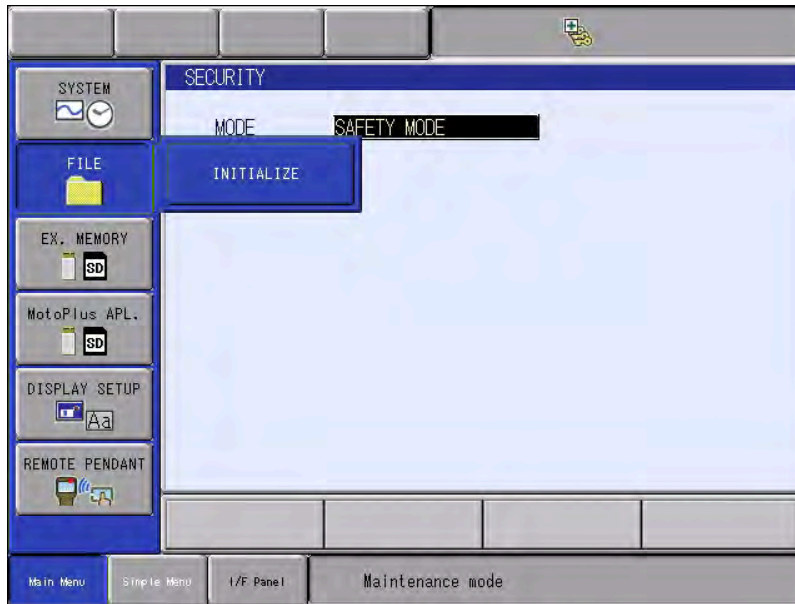

**a** Highlight **Safety Board FLASH Reset** and press **SELECT**.

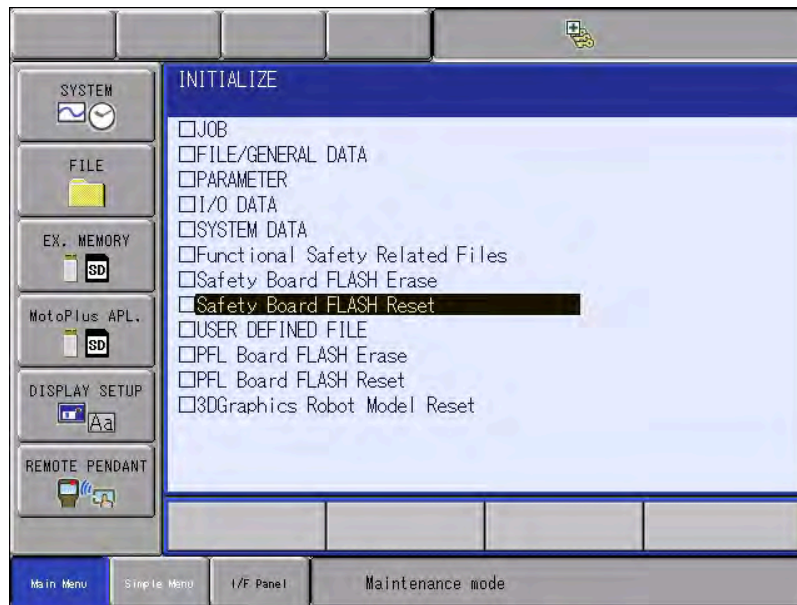

**b** At the **Reset?** prompt tap **YES**.

**c** Wait for the flash reset to complete and the pendant to beep. This process takes up to one minute to complete.

**18** Power off the Yaskawa robot controller and wait 10 seconds

- 19 Turn the Yaskawa pendant key to REMOTE.



- 20 Power on the Yaskawa robot controller.

# ADDING YOUR ROBOT IN DEVICE CONFIGURATION

In these steps, you save the robot in the Device Configuration app and finish the setup.

1 In Forge/OS, finish entering your device information:

a Give your device a name.

b If you are using the READY-made **Forge/Ctrl**, enter the IP Address **172.16.255.251**. If you are using the READY-made **Forge/Hub**, enter the IP Address **192.168.1.20**. If the IP address you assigned to the robot is different, enter that.

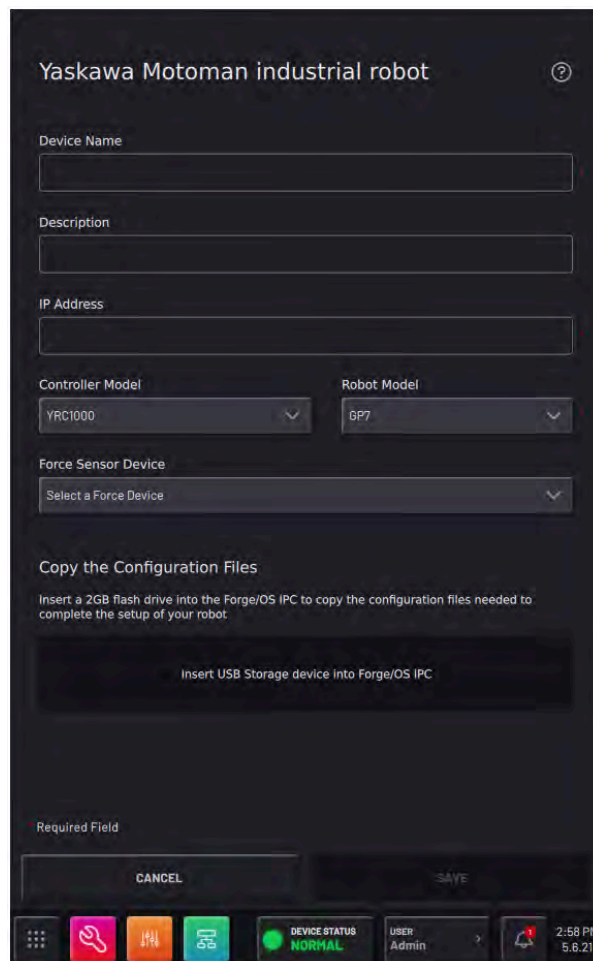

Yaskawa Motoman industrial robot

Device Name

Description

IP Address

Controller Model: YRC1000

Robot Model: GP7

Force Sensor Device: Select a Force Device

Copy the Configuration Files

Insert a 2GB flash drive into the Forge/OS IPC to copy the configuration files needed to complete the setup of your robot.

Insert USB Storage device into Forge/OS IPC

Required Field

CANCEL SAVE

DEVICE STATUS: NORMAL

USER: Admin

2:58 PM 5.8.21

2 In Forge/OS, confirm your device settings and tap **SAVE**. Forge/OS attempts to connect with the robot controller for up to 20 seconds.

**Note:** When you first connect to a robot, it's normal to see some robot errors and/or warnings on the **READY pendant**. Ignore these for now. You will clear them after you finish adding the robot to Forge/OS.

a If the robot controller fails to connect, you see this pop-up.

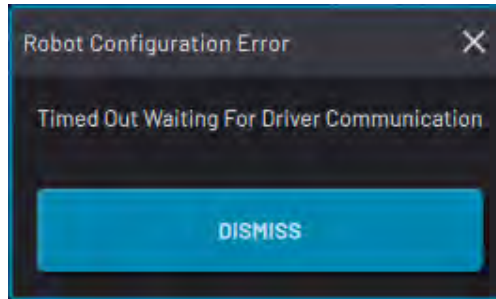

Click **DISMISS**, do the following, then try to tap **SAVE** again:

- Check the Ethernet connection between the robot controller and IPC.
- Check the network settings on the robot controller.
- Check if the robot controller is on and in the correct operating mode (in auto or remote mode).
- Select the correct robot controller and robot models in Device Configuration.

3 When the robot connects, you can add Tool Center Points (TCPs) or Payloads for the robot. You can come back to this later by editing the device's configuration. Tap **SAVE** to continue.

**Note:** The default TCP is at the robot's tool flange. The default Payload is zero.

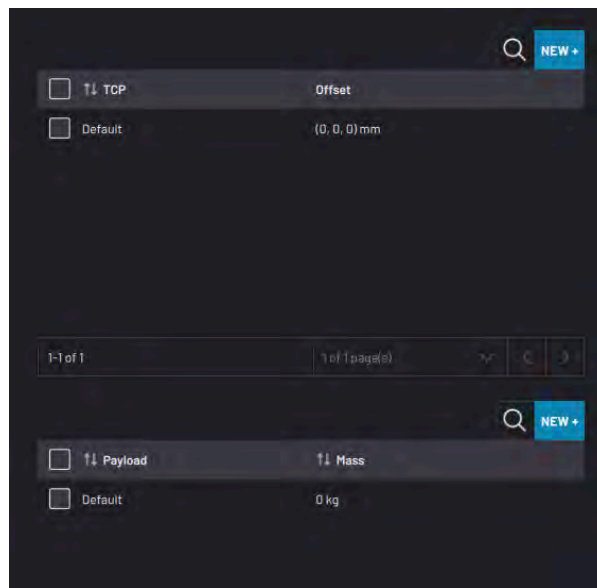

4 (Optional): Set up the robot controller's Input/Output (IO) signals for use in the Device Control Panel and Task

Canvas.

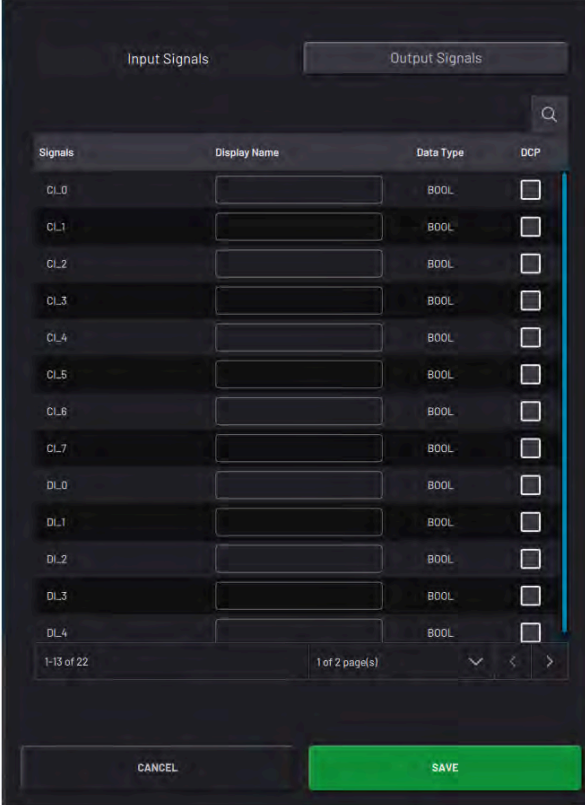

Signals	Display Name	Data Type	DCP
CL.0	<input type="text"/>	BOOL	<input type="checkbox"/>
CL.1	<input type="text"/>	BOOL	<input type="checkbox"/>
CL.2	<input type="text"/>	BOOL	<input type="checkbox"/>
CL.3	<input type="text"/>	BOOL	<input type="checkbox"/>
CL.4	<input type="text"/>	BOOL	<input type="checkbox"/>
CL.5	<input type="text"/>	BOOL	<input type="checkbox"/>
CL.6	<input type="text"/>	BOOL	<input type="checkbox"/>
CL.7	<input type="text"/>	BOOL	<input type="checkbox"/>
DL.0	<input type="text"/>	BOOL	<input type="checkbox"/>
DL.1	<input type="text"/>	BOOL	<input type="checkbox"/>
DL.2	<input type="text"/>	BOOL	<input type="checkbox"/>
DL.3	<input type="text"/>	BOOL	<input type="checkbox"/>
DL.4	<input type="text"/>	BOOL	<input type="checkbox"/>

**a** Enter a **Display Name** (i.e. "Open Machine Door", "Open Pneumatic Vise", or "Start Machining Cycle") to show what each signal does in other apps.

**b** If you want a signal to appear in the Device Control Panel, check the **DCP** box next to that signal.

**Note:** To use these I/O signals, integrate your I/O devices with the robot controller.

**c** Tap **SAVE**. Forge/OS returns to the Configured Devices list, which shows the new robot as **enabled**.

**Note:** A device is **enabled** when its switch is green and toggled to the right.

5 Follow these steps to clear robot errors:

a Tap the **Device Status** button on the Toolbar to expand the Device Status Panel. The robot is listed with two buttons: **MORE** and **RESET**.

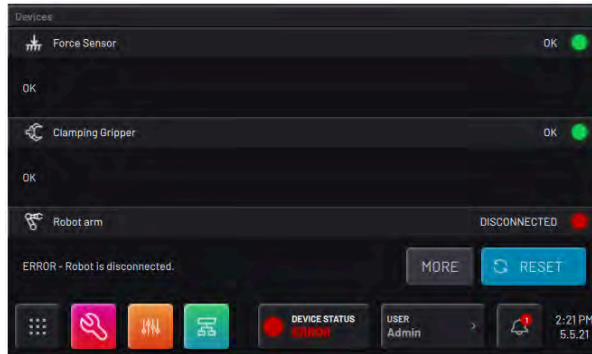

b Tap **RESET** to try to recover from the errors. If you can't **RESET** an error, tap **MORE** to get more details and instructions.

6 Review the steps in [Appendix B: Tool Loading Steps](#). Refer back to the Tool Loading Procedure whenever you create new Tool Center Points or Payloads. To save time, decide all the TCPs and Payloads you need for your application/workcell ahead of time and add them at one time.

Congratulations! You are ready to control your robot in the Device Control Panel and Task Canvas apps.

# APPENDIX A: SETTING UP FORGE/OS

## INSTALLING FORGE/OS

Follow these steps to install Forge/OS and sign in to the Admin role. Installation takes about 30 minutes, depending on the resources of the IPC.

- 1 To install Forge/OS, follow these substeps. You need a Forge/OS installation USB flash drive. Contact your READY Robotics distributor for an installation USB drive.

**Important:** Installing Forge/OS will erase all data on the target hard drive.

- a Connect a monitor, keyboard, and mouse to the IPC where you want to install Forge/OS.



- b Plug the Forge/OS installation USB flash drive into the IPC.

**Tip:** If you need more USB ports, use a USB 3.0 hub.

- c Restart the IPC. While the IPC is powering on, press the keyboard hotkey that takes you to the Boot Menu.

**Tip:** The key that opens the Boot Menu depends on the **IPC** model. The most common keys that do this are ESC, F10, F11, or F12. Refer to your computer's documentation for boot options.

**Note:** If you're installing Forge/OS on a **Forge/Ctrl**, press F11. You may need to enter the **BIOS Admin password**. Contact READY Support if you run into this issue.

- d From the boot options, select **Install Forge/OS** to boot from the installation USB flash drive.



**e** The installer may take several minutes to load. Wait until the installation wizard opens.

**f** Select your language. Then click **Install Forge**.

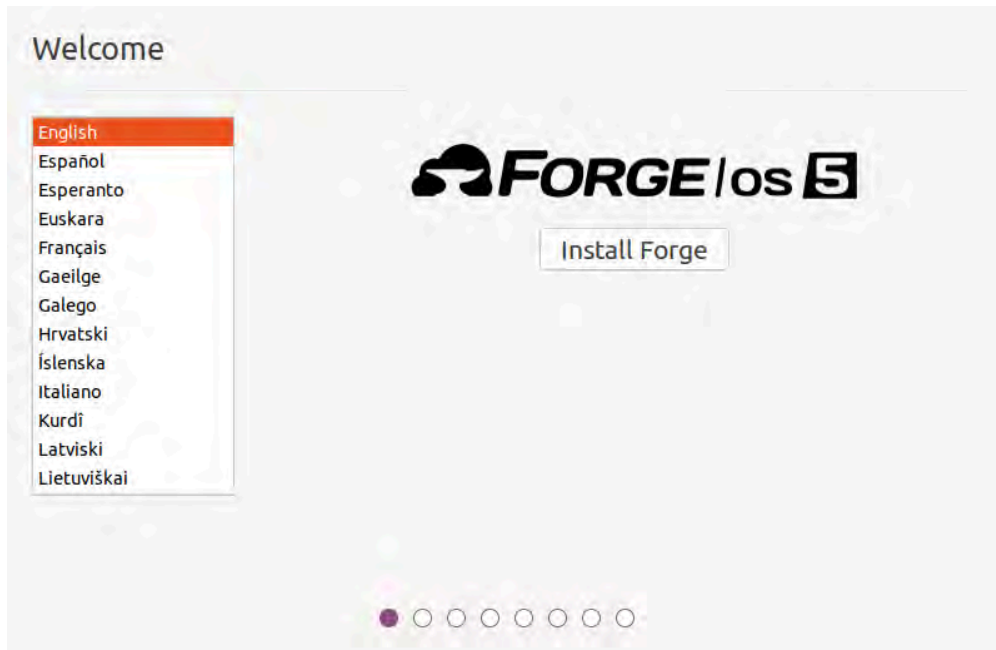

**g** Choose a keyboard layout. Then click **Continue**.

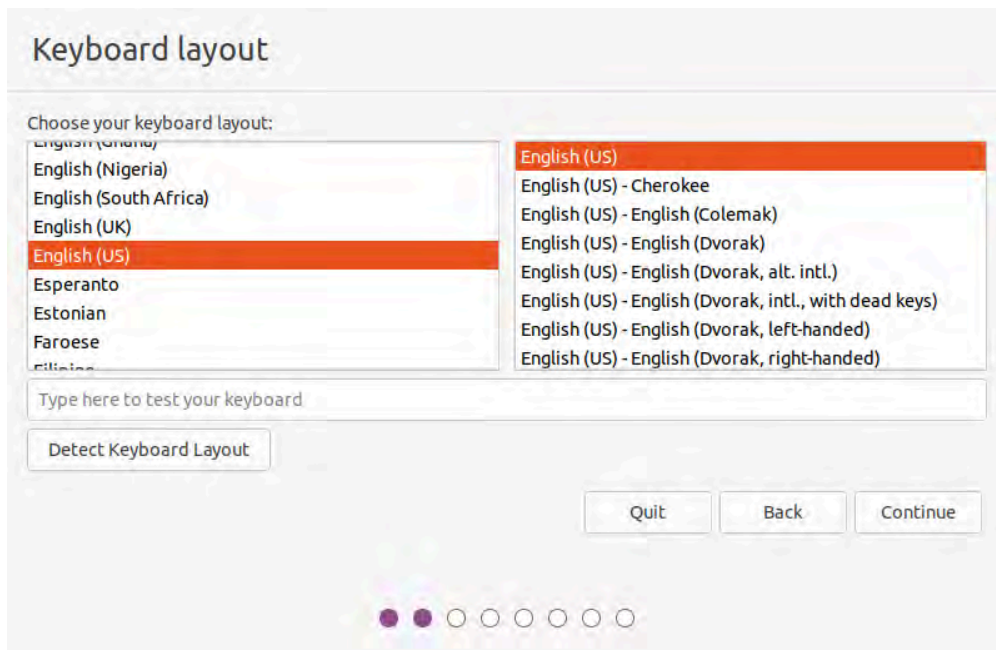

**h** Select **Minimal installation**. Uncheck **Download updates while installing forgeos**. Then click **Continue**.

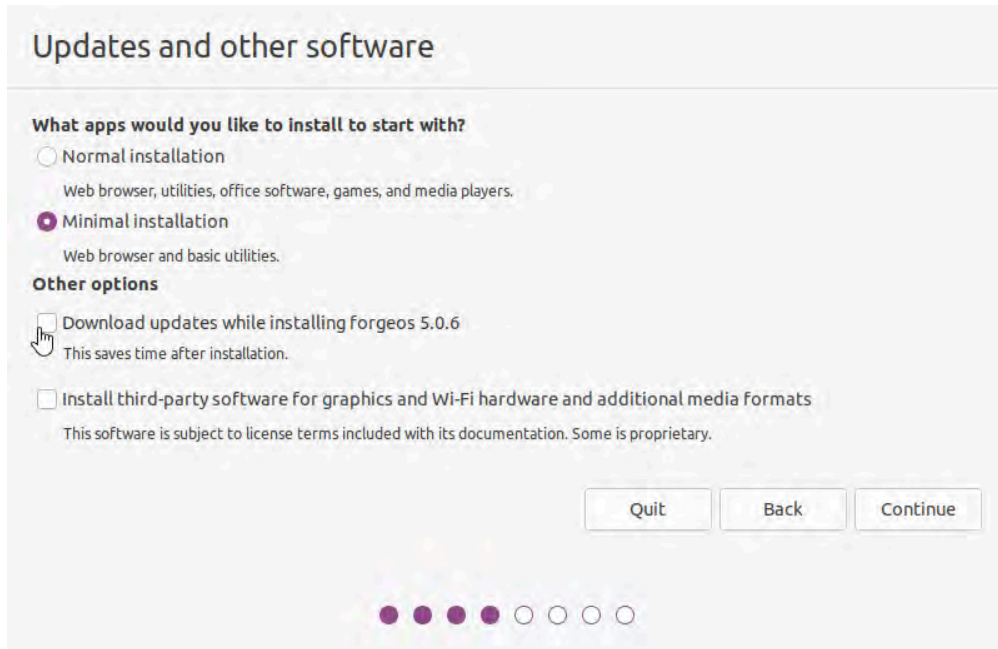

**i** Select **Erase disk and install forgeos**. Then click **Continue**.

**Note:** If Forge/OS is already installed, the installation wizard will show additional options. The goal is to erase the entire disk for a brand new installation.

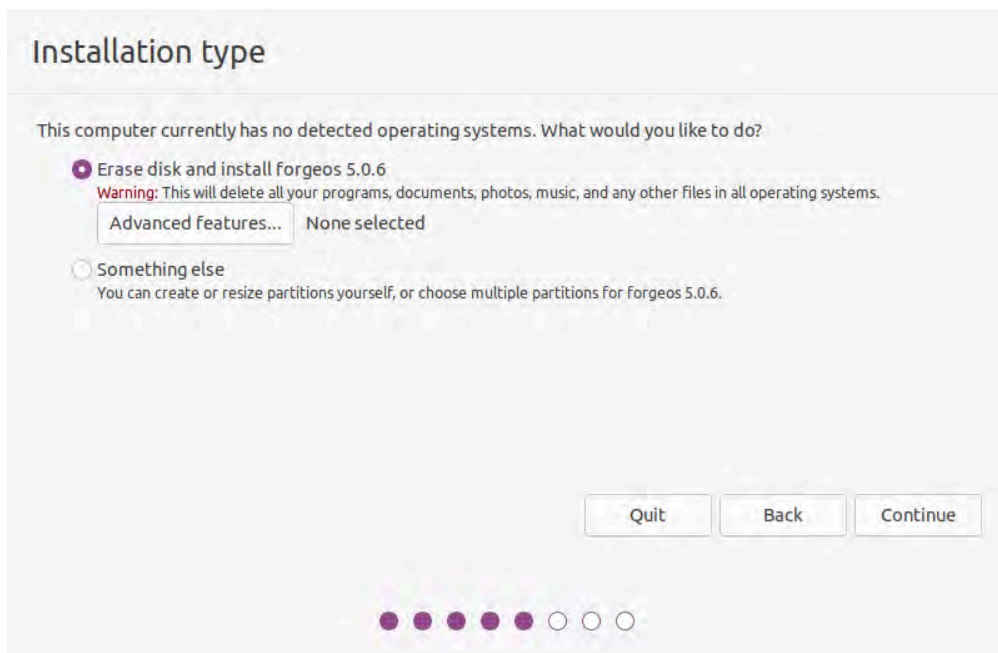

**j** Select the IPC hard drive for Forge/OS and click **Install Now**.

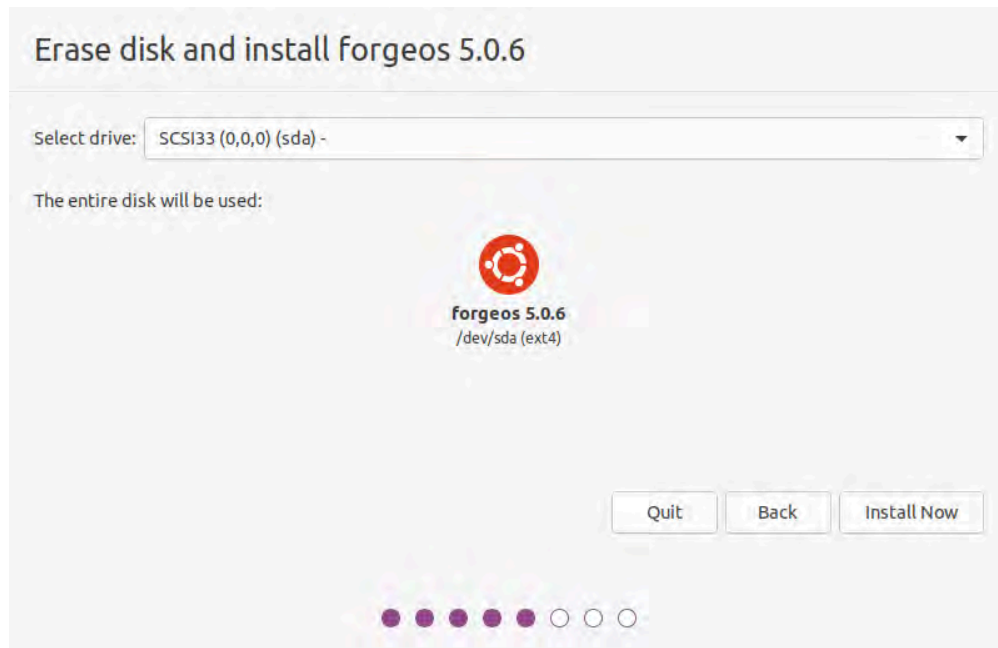

**k** Confirm that you want to erase the entire disk by clicking **Continue**.

**l** Make a note of the pendant instructions. If you're using a Forge/Ctrl, select the checkbox next to **This hardware is a Forge CTRL**.

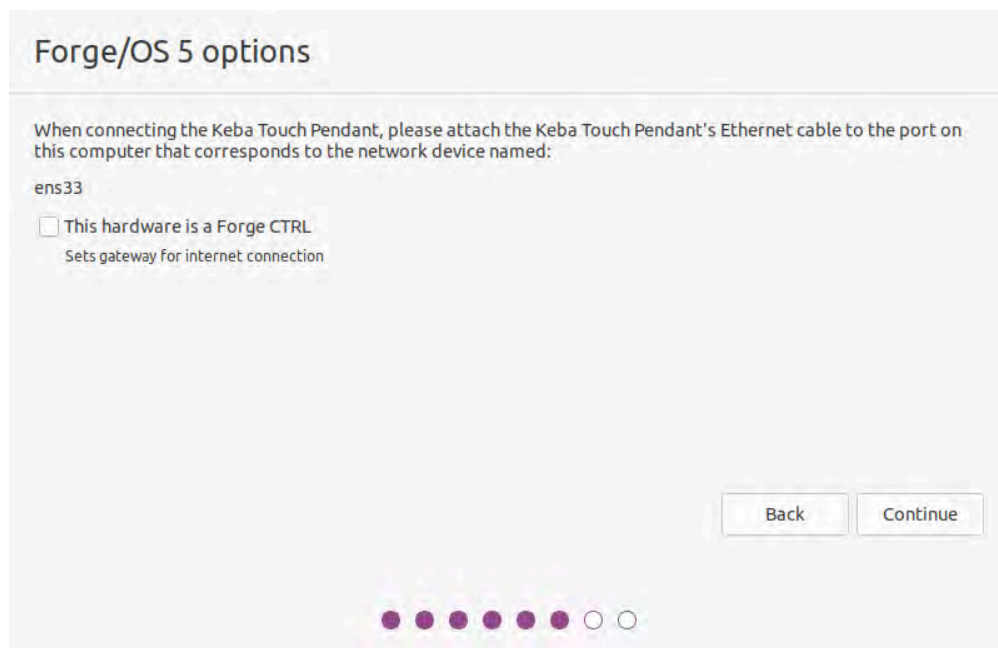

**m** Choose your timezone. Then click **Continue**.

**n** Choose your IPC's host name. The host name identifies the IPC on the network. Pick a username and password. Then click **Continue**.

**Note:** The username and password that you create here are for accessing the IPC desktop. They are NOT for signing into Forge/OS on the **READY pendant**.

- o Wait for the installer to copy and install Forge/OS.

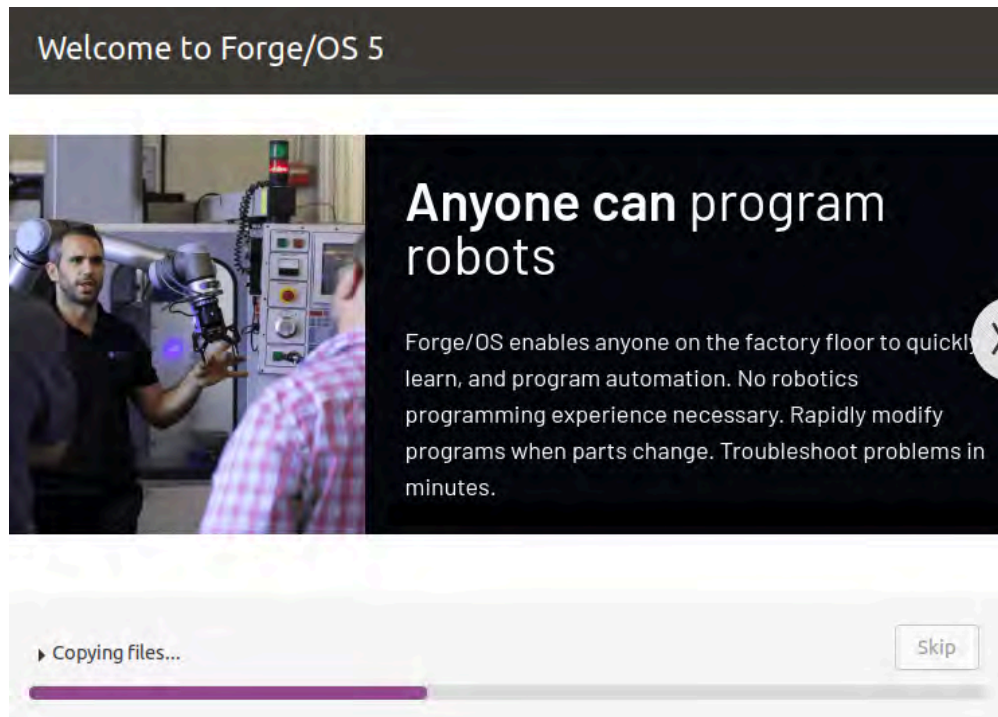

- p Once the installation completes, click **Restart Now**.

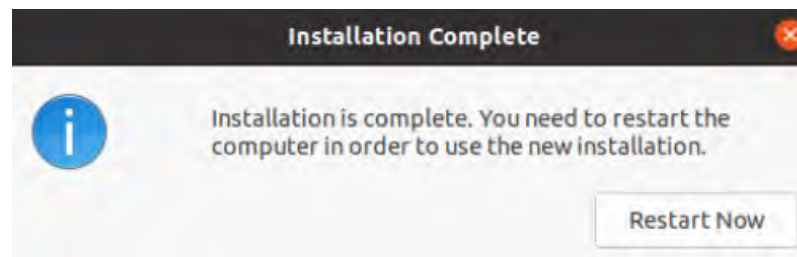

- q When prompted, remove the installation flash drive. Then reboot.

```
Please remove the installation medium, then reboot.  
_
```

- r Wait for Forge/OS to finish booting.

**S**

When you see the login screen with the Forge/OS 5 logo, Forge/OS is ready to run on the READY pendant! You don't need to sign in to the desktop. Disconnect the monitor, keyboard, and mouse that you used to install Forge/OS.

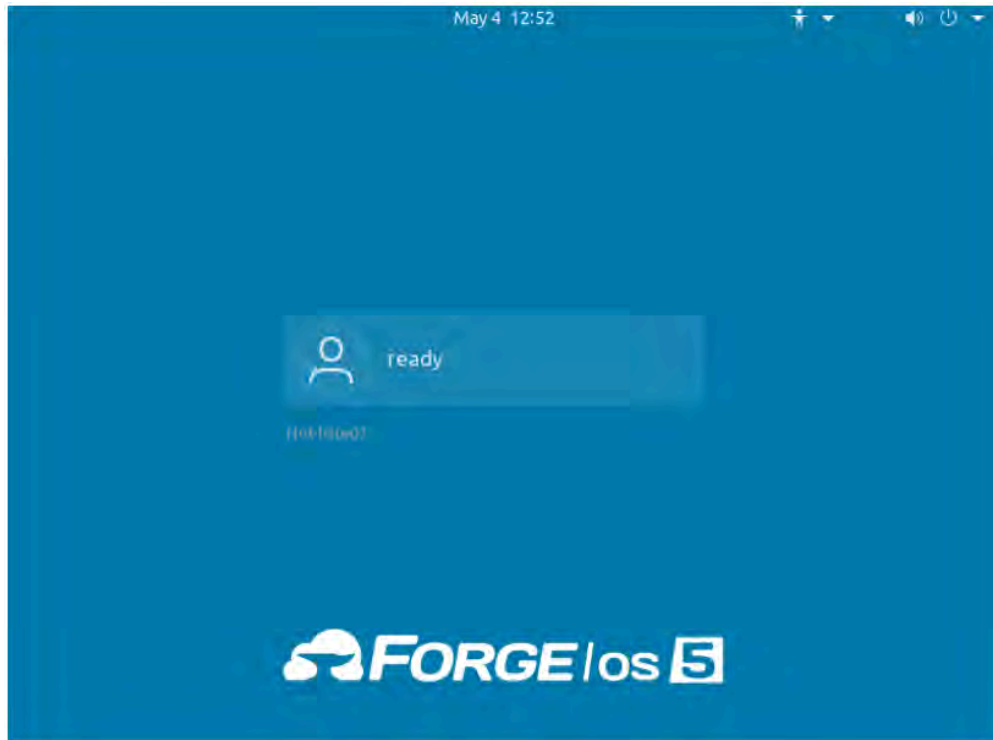

2 The READY pendant automatically finds and pairs with the IPC. The three LEDs on the screen help you track the status:

- **Pendant Network Connection:** This condition is satisfied when the READY pendant has a valid network connection (i.e., the Ethernet cable is plugged in).
- **Forge/OS IPC Detected:** This condition is satisfied when the READY pendant detects a Forge/OS IPC on the network.
- **Forge/OS IPC Paired:** This condition is satisfied when the READY pendant successfully pairs with the IPC. If pairing fails, it is automatically retried indefinitely.

When a condition is not satisfied, the LED is red. When a condition is in progress of becoming satisfied, a spinner around a READY logo appears to the right of the text. When a condition becomes satisfied, the LED turns green.

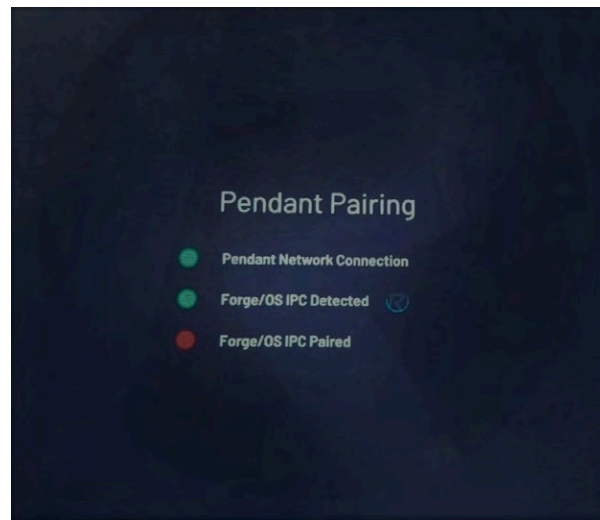

The UI shows the real-time state of each step. For example, if the pendant loses its network connection during pairing, all steps become undone.

If the READY pendant spends more than 60 seconds on any step, troubleshooting text displays. Common things to check are if the READY pendant network cable is plugged in, if the IPC is powered on, if the READY pendant and IPC are connected to the same network, and if there's only one READY pendant and one IPC on that network.

- 3 Tap **Admin** and sign in. The default Admin password is "forgeadmin".

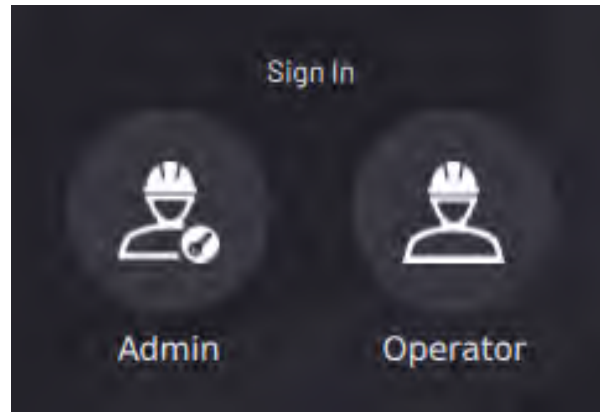

**Note:** After installation, you have limited access to Forge/OS until you activate it with a license code. See [Activating Forge/OS with a License Code](#).



# ACTIVATING FORGE/OS WITH A LICENSE CODE

There are two methods to activate Forge/OS: **Online license activation** and **offline license activation**.

The table below lists the requirements for each method.

Online License Activation	Offline License Activation
<ul style="list-style-type: none"> <li>▪ An internet-connected Forge/OS</li> <li>▪ A valid Forge/OS license code</li> </ul>	<ul style="list-style-type: none"> <li>▪ A 2GB or larger USB flash drive</li> <li>▪ An internet-connected PC</li> <li>▪ A valid Forge/OS license code</li> </ul>

**Tip:** Connect a USB keyboard to the port on the bottom of the **READY pendant** to type in any text field in Forge/OS.

- 1 On the Settings app main screen, tap **License**.

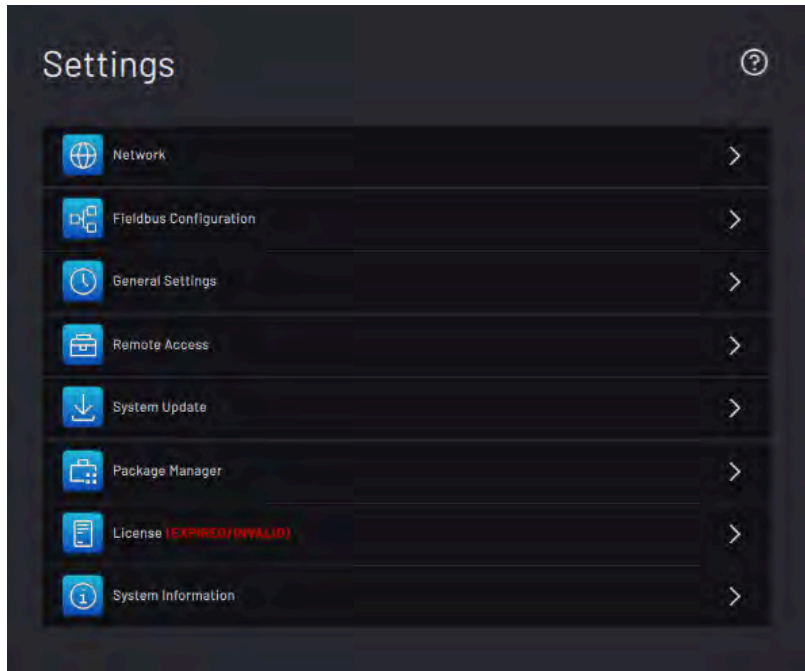

- 2 Type in your license code.

- 3 Choose **ONLINE LICENSE ACTIVATION** if Forge/OS is connected to the internet. If not, choose **OFFLINE LICENSE ACTIVATION**.

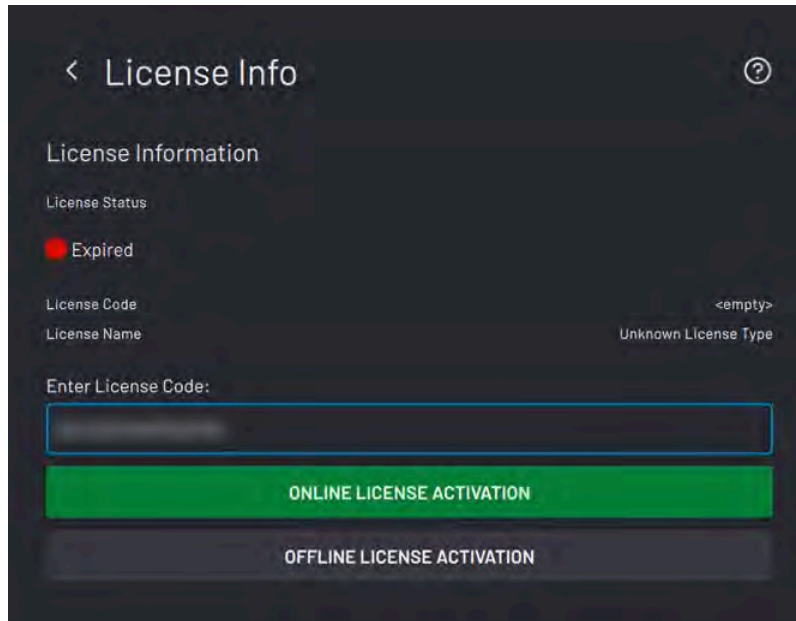

- 4 If you chose online license activation, you're done!

- 5 If you chose offline license activation, follow these substeps:

- a Insert the USB flash drive into your IPC. Tap **START WRITING CERTIFICATE TO USB DRIVE**.

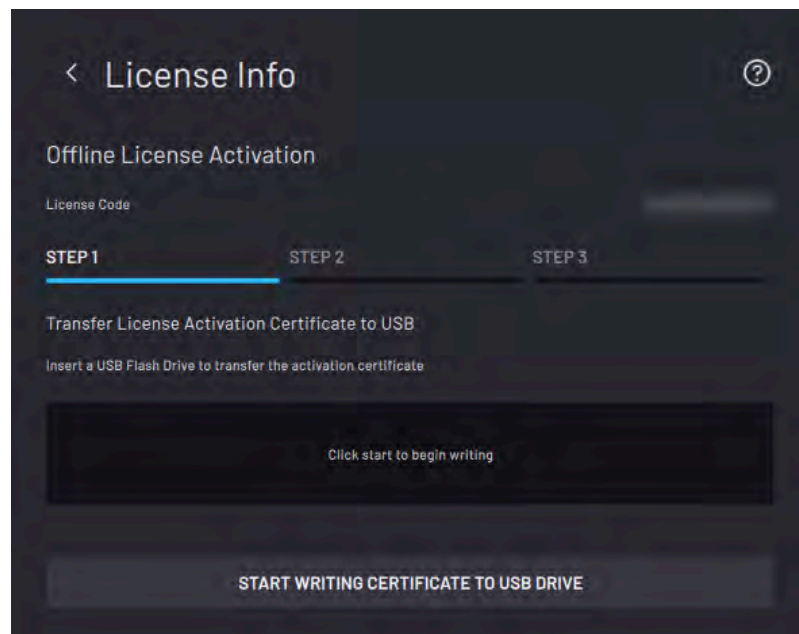

- b** When the files finish transferring, tap **NEXT**. Follow the instructions on the screen to convert the Activation Certificate to an Unlock Certificate using an internet-connected PC.

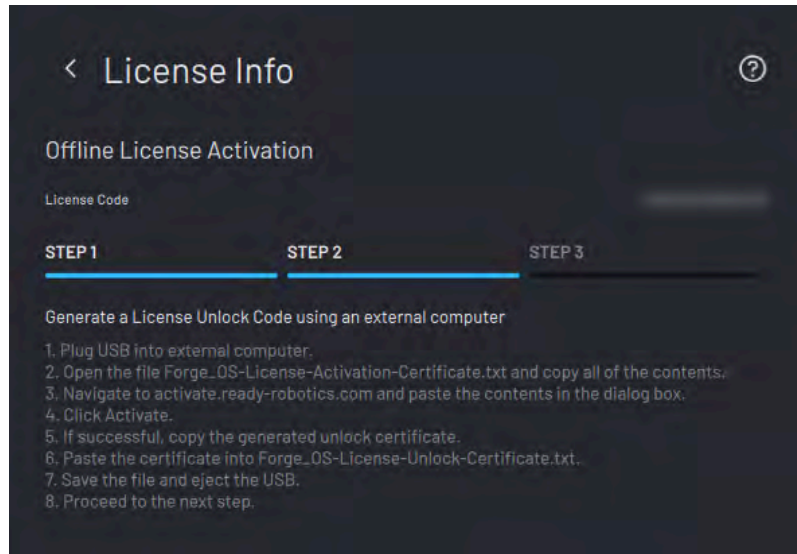

- c** Insert the USB flash drive back into your IPC. Tap **UNLOAD UNLOCK CERTIFICATE FROM USB DRIVE**.

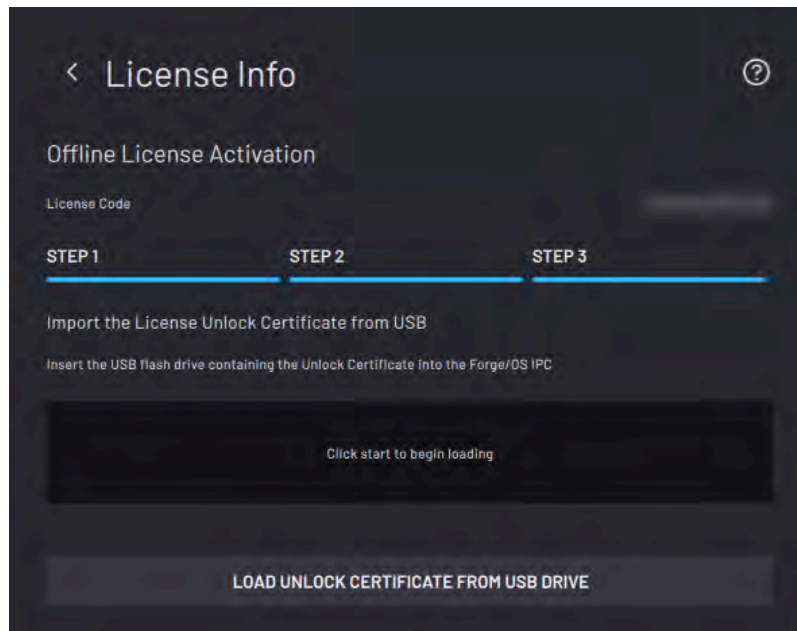

- d** Wait for the file to finish transferring. When the file transfer is complete, remove the USB flash drive and tap **SAVE**.
- e** Forge/OS returns to the licensing home screen and shows an active license. If the license status isn't active, restart these license activation steps. Double-check your license code.

# CHOOSING PREFERENCES

These steps help you choose system preferences, including language, units, time, and network settings.

**1** To change preferences for the first time, go to General Settings:

**a** On the Settings app main screen, tap **General Settings**.

**b** Change the Units of Measure, Time and Date settings, or the Admin login password.

**Note:** If you later forget your password, contact READY Robotics to reset it.

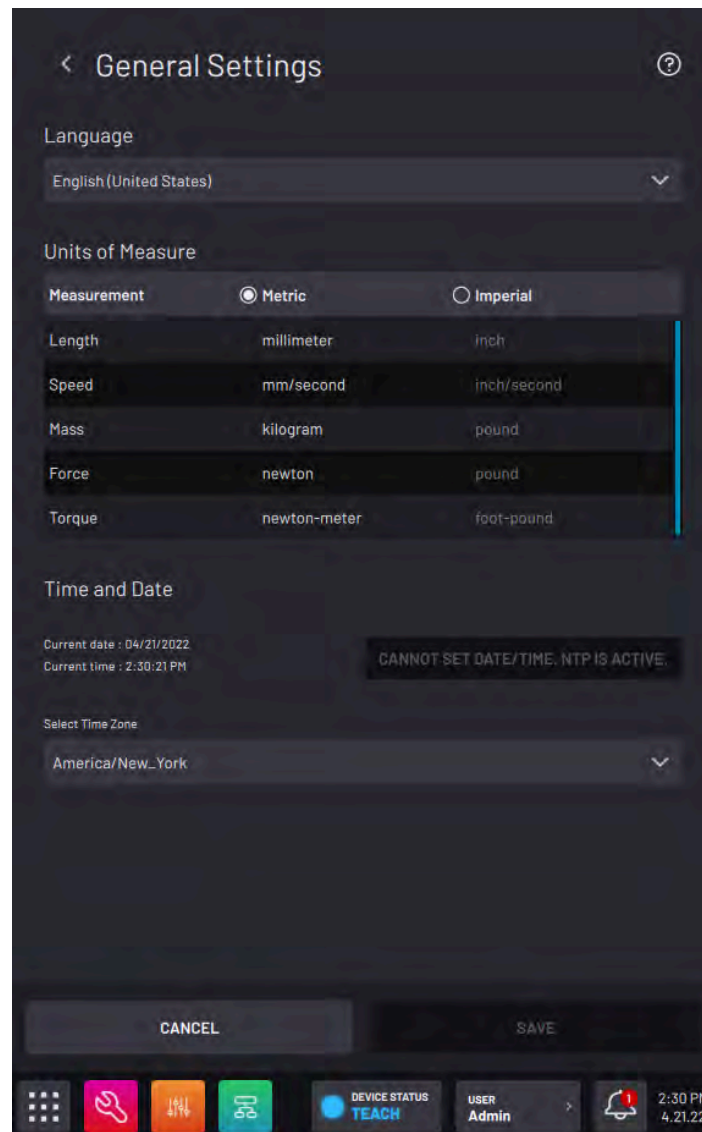

**c** Tap **SAVE** to save changes and exit the General Settings menu.

# APPENDIX B: TOOL LOADING STEPS

You must update the tool files on the Yaskawa controller each time you add new Tool Center Points (TCPs) or Payloads. Follow these steps to add new TCPs/Payloads in Forge/OS and update the Tool configuration on the Yaskawa controller.

Here is an outline of the tool loading process:

- Add TCPs/Payloads to the robot's configuration in Forge/OS and save.
- Forge creates a TOOL.CND file and saves it to the USB drive on the robot controller.
- Load the tool file onto the robot controller while in Safety mode.
- Reset the safety systems on the robot controller in Maintenance-Safety mode.

1 Make sure there is a USB flash drive in the Yaskawa pendant.

2 In Forge/OS, go to the Device Configuration app and find the Yaskawa robot under Configured Devices. Select the device and tap **Edit** to open the robot configuration.

3 Tap **TCP AND PAYLOAD CONFIGURATION**.

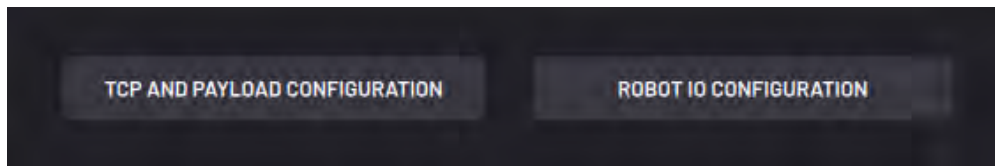

4 Add all the TCPs and Payloads you need for your workcell and tap **SAVE**.

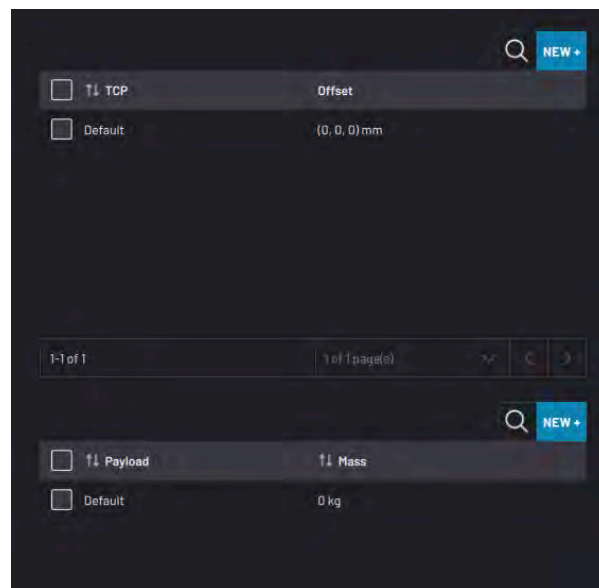

- 5 Tap **SAVE** to exit the robot configuration. Forge/OS uploads a tool data file to the USB drive attached to the Yaskawa pendant. If you didn't see one before, you will see a Tool Mismatch error now.

**Note:** Forge/OS saves the updated TCPs and Payloads to **tool.cnd** in the USB drive root directory, not in the **forge-os** folder.

- 6 Switch the Yaskawa pendant to TEACH and select Safety Mode:

- a Turn the key to TEACH.



- b From the Main Menu, navigate to **SYSTEM INFO**, then **SECURITY**.
- c Select **SAFETY MODE** from the dropdown list.
- d Enter the **SAFETY MODE** password and press the **ENTER** button on the pendant keypad.

7 From the Main Menu, tap **EX. MEMORY**, then tap **LOAD**.

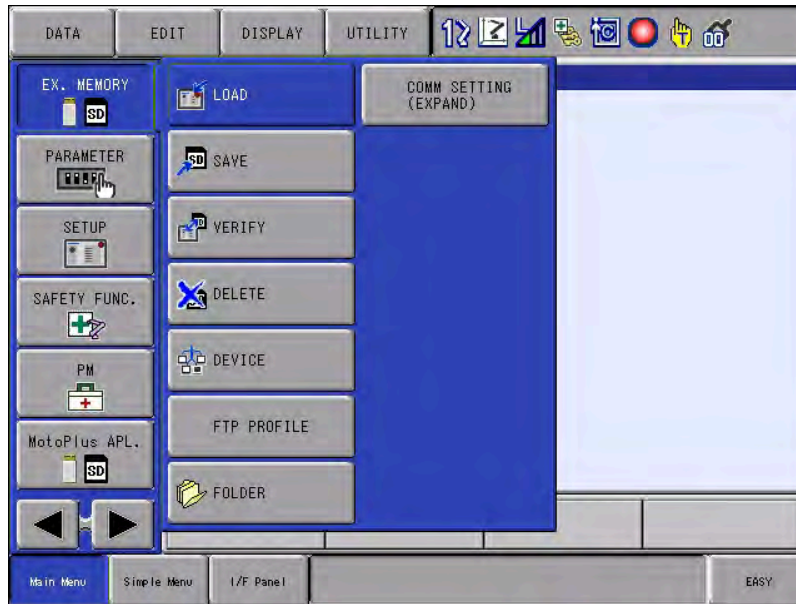

a Select **FILE/GENERAL DATA**.



**b** Highlight **TOOL DATA** and press **SELECT**. Then press **ENTER**.



**c** At the **Load?** screen select **YES**.

**8** Power off the robot controller and wait 10 seconds.

**9** Power on the robot controller while holding the **Main Menu** button on the Yaskawa pendant to boot in Maintenance Mode. Continue to hold the button until the pendant beeps.

**10** On the Yaskawa pendant:

**a** Make sure the key is still in the "TEACH" position (counterclockwise).

**b** From the Main Menu, tap **SYSTEM**, then tap **SECURITY**.

**c** Select **SAFETY MODE** from the dropdown list.

**d** Enter the **SAFETY MODE** password and press **ENTER**.



- 11 Save changes to the Safety I/O board. From the Main Menu, tap **FILE**, then **INITIALIZE**.

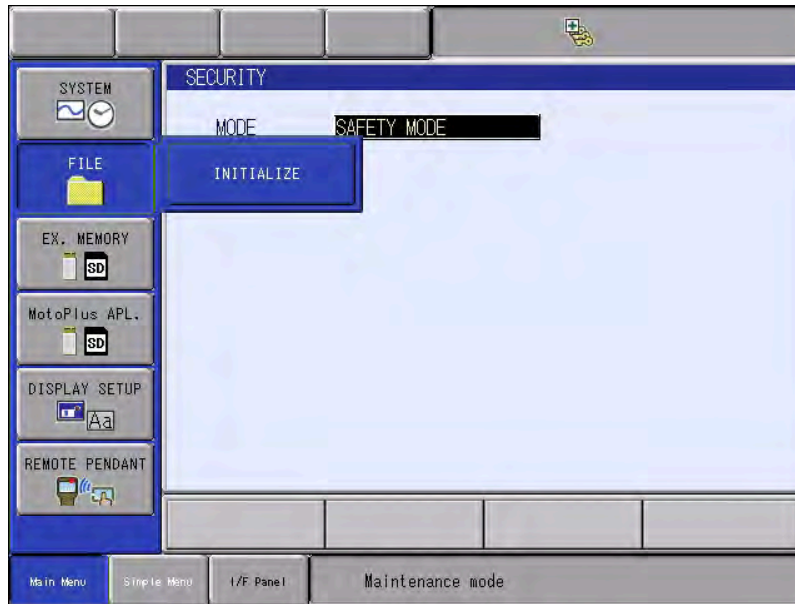

- a Select **Safety Board FLASH Reset**.

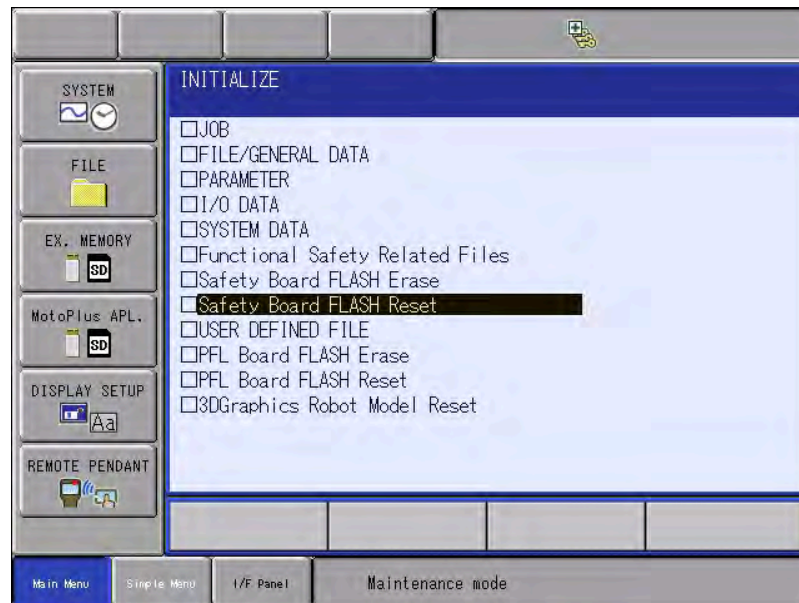

- b When prompted select **YES**.

- c Wait for the flash reset to complete and the pendant to beep. This process takes up to one minute to complete.

- 12 Turn the key to the REMOTE.



- 13 Power off the robot controller and wait 10 seconds.

- 14 Power on the robot controller. When Forge/OS reconnects to the robot controller after the final power cycle, you can clear the "TOOL MISMATCH" warning.

# APPENDIX C: TROUBLESHOOTING

Issue #1 "Unauthorized User" error. This issue occurs when you input an incorrect safety mode password.

- 1 If you are using a collaborative robot, enter in your 16-digit custom safety mode password from the "Collaborative Password Agreement" If you do not have that on hand, call Yaskawa Support with your Warranty ID number and they will provide it to you.
- 2 If you are using a non-collaborative robot, try re-entering the default safety mode password (5555 5555 5555 5555). If this doesn't work, contact Yaskawa Support.

Issue #2: "Alarm 4751 unmatched of general safety input signal functionality is detected by ASF02 board". This alarm occurs when there is a mismatch of safety I/O signals.

- 1 Check the Functional Safety Breakout wiring against the wiring diagram in the READY pendant wiring section.
- 2 Check the safety fence jumper wires on the safety terminal block.

Issue #3 "I/O Media Error". This error occurs if the Yaskawa pendant cannot read the USB flash drive you inserted.

- 1 Boot the Yaskawa controller in Maintenance Mode. Go to the Main Menu on the Yaskawa pendant, select **EX.MEMORY**, and select **DEVICE**.

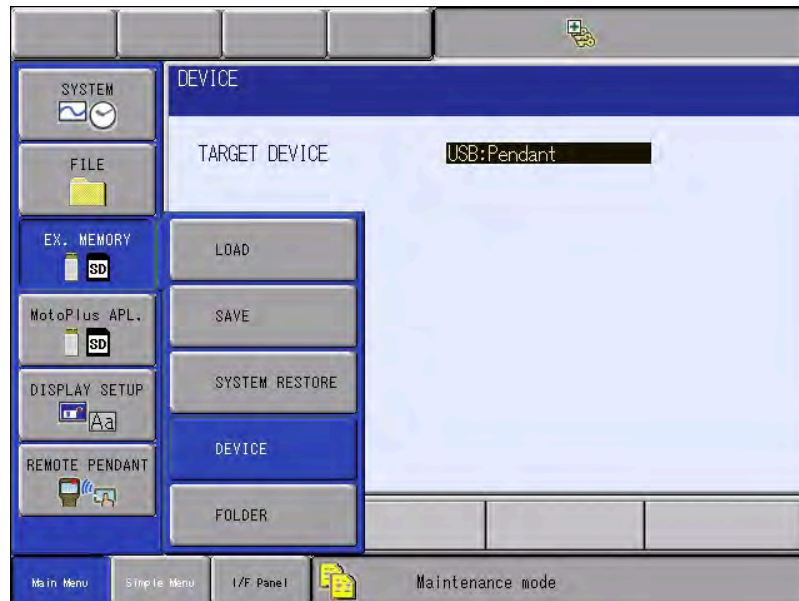

- 2 If the **Target Device** is set to read an SD card (**SD: Pendant**), change the field to **USB:Pendant**.

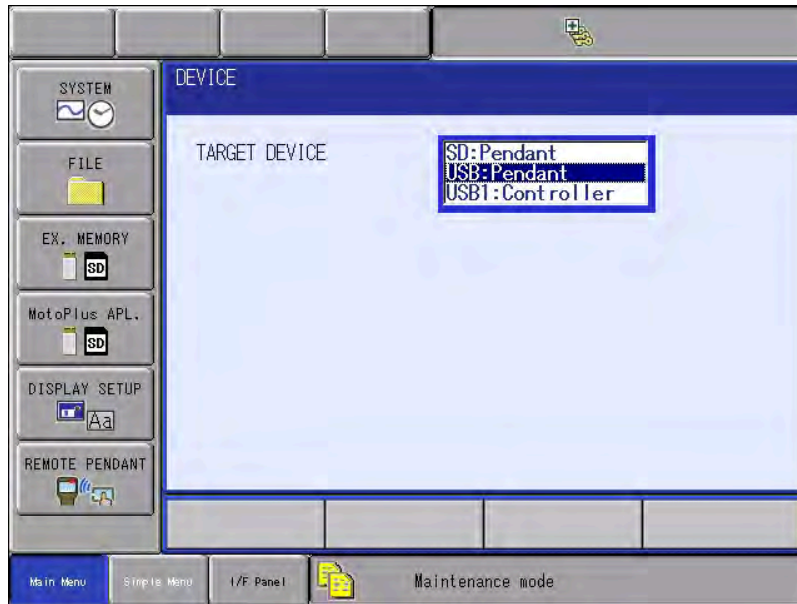

- 3 If the Target Device is set to USB and you continue getting this alarm, contact Yaskawa Support.

Issue #4: "Tooling Mismatch" alarm in Task Canvas. This alarm occurs if an end-of-arm tool is attached to the robot, and you have not completed the Tool Loading Procedure.

- 1 Make sure a USB drive is connected to the Yaskawa pendant and reapply the Device Configuration in Forge/OS. Then re-run the Tool Loading Procedure.

- 2 If you continue getting this alarm, make sure the following are true:

- The Yaskawa software is in the SAFETY operating mode.
- The Yaskawa pendant key switch is in TEACH position.
- CRC checks for uploaded files is set to disabled.

Issue #5 The robot hits an unnecessary protective stop when jogging.

- 1 Check if you set the correct active payload correctly in Forge/OS. Make sure the Device Configuration provides accurate payload mass and center-of-mass settings for the tool.

- 2 If using a custom tool, calculate its tool center point offset and rotation, and label the tool with these values. Incorrect values will lead to the robot not moving accurately relative to its tool center point.

- 3 **For collaborative robots:** If the Device Configuration and active payload are accurate, check the maximum collaborative force permitted. The Yaskawa "Collaborative Robot Password Agreement" indicates that the default maximum force threshold is set to 50N. Update the maximum force permitted setting in accordance with safety assessment.

Issue #6 “MotoPlus failed to create task” message appears on the Yaskawa pendant.

- 1 Reboot the Yaskawa robot controller.
- 2 If you continue getting this alarm, contact Yaskawa Motoman Support.

Issue #7 Forge/OS cannot connect to the robot device after adding it.

- 1 Check the Ethernet cable to the Yaskawa controller.
- 2 Check the network settings on the Yaskawa pendant.
  - 1 Boot the robot controller in maintenance mode and switch to the Safety security mode.
  - 2 Select LAN Interface Settings in Option Functions.
- 3 Check the IP address of your robot in Forge/OS Device Configuration.
- 4 Reboot the Yaskawa robot controller.

Issue #8: Loading the Configuration File (CIOPRG.LST) fails. If an old copy exists on the Yaskawa pendant (so that the robot otherwise works with Forge/OS, such as when updating from Forge/OS 5.2 to 5.3), you can follow the manual workaround outlined below. Otherwise, the robot's speed will not immediately adjust with the speed slider.

- 1 In SAFETY MODE with the Yaskawa pendant in TEACH mode, navigate to the **IN/OUT > LADDER EDITOR** menu.

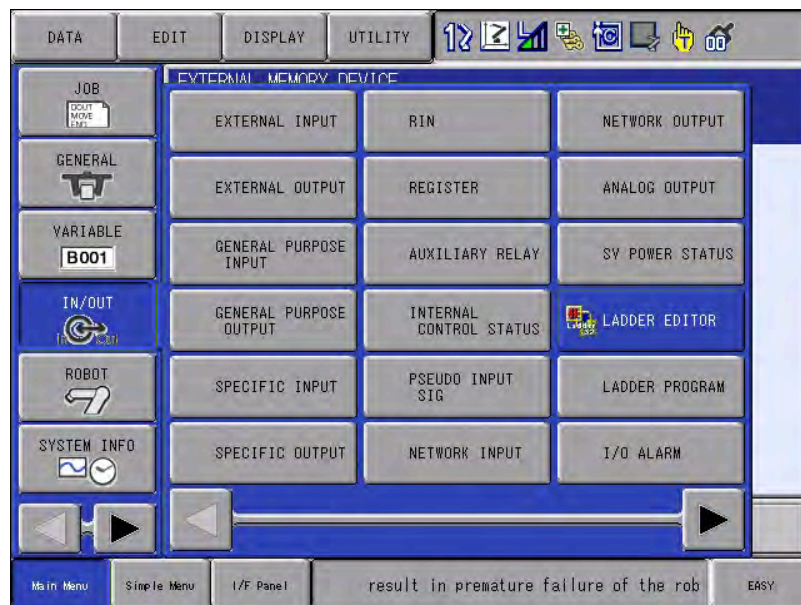

- 2 Scroll down to the bottom of the list of signals. Highlight the last entry. On the right side of the screen, select **EDIT > INSERT NEW RUNG**.
- 3 With the new rung highlighted, open the Ladder Editing Window (either by double tapping on the new rung or pressing the SELECT button).

- 4 There are two signals in this rung: the input signal located on the left (row 00 column 00) and the output signal on the right (row 00 column 09).
- 5 Change the input signal to **15090**. You can do this either by double tapping the signal or by highlighting it, selecting **INPUT > INPUT VALUE**, and then pressing the SELECT button.
- 6 Change the output signal to **05110**.
- 7 Save the changes by navigating to the **EDIT > SAVE RUNG (OVERWRITE)** on the right side of the screen.
- 8 Repeat steps 2-7, increasing the signal number by one until the last entry has **15097** for the read signal and **05117** for the write signal. There are to be 8 new entries total.
- 9 Select **EDIT > COMPILE**.

*Tip: If compiling fails, check that the pendant is in TEACH mode and that all the signals are correct.*

# RESOURCES

Want to learn more about how Forge/OS can empower you?

Visit **READY.academy** ([ready.academy](https://ready.academy)) for *FREE* hands-on courses to help you deploy a robotic system.

Visit **READY.market** ([market.ready-robotics.com](https://market.ready-robotics.com)) for products and services offered by READY and our partners.

Visit our **Support** site ([support.ready-robotics.com](https://support.ready-robotics.com)) for robot startup guides, FAQs, and more.

Visit our **Resources** page ([ready-robotics.com/resources](https://ready-robotics.com/resources)) for articles, whitepapers, and other resources.

If you encounter a problem and need to talk to someone, reach out to us.

- Email READY Robotics: [support@ready-robotics.com](mailto:support@ready-robotics.com)
- Call READY Robotics: +1-833-732-3977

