

# MAHLE

## E-MOBILITÄT & ELEKTRONIK E-MOBILITY & ELECTRONICS



Aftermarket 2019/2020

[WWW.MAHLE-AFTERMARKET.COM](http://WWW.MAHLE-AFTERMARKET.COM)



# ÜBERBLICK

<b>Verpackung</b>	02
<b>Katalog-Anwendung</b>	
Wichtige Hinweise	03
Weitere Kataloge	04
<b>Produktteil</b>	37–90
<b>Vergleichsliste Fahrzeughersteller</b>	91–96

<b>DE</b>	<b>Zu diesem Katalog</b>	01–04
<b>EN</b>	<b>About this catalog</b>	05–08
<b>FR</b>	<b>Informations concernant ce catalogue</b>	09–12
<b>ES</b>	<b>Acerca de este catálogo</b>	13–16
<b>IT</b>	<b>Su questo catalogo</b>	17–20
<b>PL</b>	<b>Informacje o niniejszym katalogu</b>	21–24
<b>RU</b>	<b>Информация о каталоге</b>	25–28
<b>TR</b>	<b>Bu katalog hakkında</b>	29–32
<b>AR</b>	<b>حول هذا الكatalog</b>	36–33

# NEUES VERPACKUNGSDESIGN EINFACH. KLAR. ÜBERSICHTLICH.

Die neuen MAHLE Aftermarket Verpackungen bieten einige Vorteile: Kräftige Farben, prägnante Informationen und eine übersichtlichere Gestaltung erleichtern das Handling in Handel und Werkstatt.

Nicht verändert haben wir die MAHLE Sicherheitsetiketten – damit Sie MAHLE Originalverpackungen auch künftig zuverlässig erkennen.

## ALLE ÄNDERUNGEN IM ÜBERBLICK

### DIE VORTEILE DER NEUEN VERPACKUNGEN

- 1 MAHLE Original wird zu MAHLE – für mehr Klarheit
- 2 Kräftige, vollflächige Farben für starke Fernwirkung, fast alle Verpackungen sind blau – auch für Kühlung und Klimatisierung von BEHR (bisher orange) und MAHLE Motorenteile (bisher rot)
- 3 Neue, lesefreundliche Platzierung der Produktbezeichnung
- 4 Zusätzlich unterstützende Illustrationen für die Produkte
- 5 Reduktion der Information auf das Wesentliche



Abbildung nur beispielhaft

# WICHTIGE HINWEISE

Die Original-Ersatzteil-Nummern der Fahrzeug- und Motorenhersteller dienen nur internen Vergleichszwecken. Sie sind keine Herkunftsbezeichnung und dürfen Fahrzeugbesitzern gegenüber nicht verwendet werden.

Die Zusammenstellung und der Druck dieses Katalogs erstrecken sich über einige Wochen. Infolgedessen können eventuell die letzten Neuzugänge nicht erfasst sein. Ebenso ist es mitunter möglich, dass das Produkt während der Serienproduktion geändert wurde. Grundsätzlich ist es sinnvoll, mit uns oder unseren Vertriebspartnern Rücksprache zu halten.

Unsere Produkte dürfen nur von fachkundigem Personal ein- bzw. verbaut werden.

Die Angaben in diesem Katalog sind sorgfältig bearbeitet, für die Richtigkeit der Daten übernehmen wir keine Gewähr.

Änderungen der Motoren- und Typenbezeichnungen seitens der Hersteller sowie der Produkte unterliegen gleichfalls diesem Vorbehalt.

Mit Erscheinen dieses Katalogs verlieren die früheren Ausgaben ihre Gültigkeit. Wir behalten uns alle Rechte vor. Nachdrucke und Auszüge sind nur mit unserer vorherigen schriftlichen Genehmigung gestattet. Missbrauch wird verfolgt.

# WEITERE KATALOGE

VON MAHLE AFTERMARKET SIND FOLGENDE  
NACHSCHLAGEWERKE ERHÄLTlich:

- Kolben/Zylinder/Assemblies
- Kolbenringsätze
- Gleitlager
- Ventiltriebkomponenten
- MAHLE Classic Line
- Filter für Pkw und Transporter
- Filter für Lkw, Busse und Transporter
- Filter für Land- und Baumaschinen und sonstige Motoren
- Filter für Motorräder
- Filter Vergleichsliste
- Thermostate für Pkw, Transporter, Busse und Lkw

- Turbolader für Pkw, Transporter, Busse und Lkw
- Generatoren und Starter für Lkw und Busse
- Generatoren und Starter für Land- und Baumaschinen und sonstige Motoren
- Elektromotoren
- Klimakompressoren

Das komplette Produktprogramm finden Sie mit ein paar Klicks unter [www.mahle-aftermarket.com](http://www.mahle-aftermarket.com).

Darüber hinaus sind die Daten zur kompletten MAHLE Aftermarket Produktpalette auch auf TecDoc verfügbar.



Das Gesamtprogramm ist auch im Internet abrufbar unter [www.mahle-aftermarket.com](http://www.mahle-aftermarket.com)

# OVERVIEW

<b>Packaging</b>	06
<b>Catalog use</b>	
<b>Important information</b>	07
<b>Additional catalogs</b>	08
<b>Product section</b>	37–90
<b>Comparison list of vehicle manufacturers</b>	91–96

<b>DE</b>	<b>Zu diesem Katalog</b>	01–04
<b>EN</b>	<b>About this catalog</b>	05–08
<b>FR</b>	<b>Informations concernant ce catalogue</b>	09–12
<b>ES</b>	<b>Acerca de este catálogo</b>	13–16
<b>IT</b>	<b>Su questo catalogo</b>	17–20
<b>PL</b>	<b>Informacje o niniejszym katalogu</b>	21–24
<b>RU</b>	<b>Информация о каталоге</b>	25–28
<b>TR</b>	<b>Bu katalog hakkında</b>	29–32
<b>AR</b>	<b>حول هذا الكatalog</b>	36–33

# NEW PACKAGING DESIGN SIMPLE. CLEAR. COMPACT.

The new MAHLE Aftermarket packaging offers a number of advantages: bold colors, concise information, and a clearer design will facilitate handling in trade and workshops.

The MAHLE security labels will remain unchanged—to ensure that you can reliably identify the MAHLE original packaging in the future as well.

## ALL CHANGES AT A GLANCE

### THE BENEFITS OF THE NEW PACKAGING

- 1 MAHLE Original will become MAHLE—for greater clarity
- 2 Bold, full-surface colors for a strong impact at a distance; almost all packaging is blue, including for engine cooling and air conditioning from BEHR (previously orange) and MAHLE engine components (previously red)
- 3 New reader-friendly placement of product description
- 4 Additional supporting illustrations for the products
- 5 Only the essential information is displayed



Illustration for example purposes only



# IMPORTANT INFORMATION

The original spare part numbers of vehicle and engine manufacturers are given for internal comparison purposes only. They do not denote the origin of the parts and must not be used in connection with the vehicle owner.

The compilation and printing of this catalog takes several weeks. The latest additions may therefore not be included. It is also possible that the product may have had to be changed during series production. It is generally advisable to consult us or our sales partners.

Our products must only be installed or fitted by specialist personnel.

The information in this catalog has been carefully prepared; however, we do not assume any liability for the correctness of the data.

Changes to the engine and type designations on the part of the manufacturer, as well as to the products, are also subject to this proviso.

Upon publication of this catalog, all previous versions cease to be valid. Copyright reserved. Reproductions or extracts require our written permission. Misuse will be prosecuted.

# ADDITIONAL CATALOGS

THE FOLLOWING CATALOGS ARE AVAILABLE FROM  
MAHLE AFTERMARKET:

- **Pistons/cylinders/assemblies**
- **Piston ring sets**
- **Bearings**
- **Valve train components**
- **MAHLE Classic line**
- **Filters for passenger cars and vans**
- **Filters for trucks, buses, and vans**
- **Filters for agricultural and construction machinery and other engines**
- **Filters for motorcycles**
- **Comparison list of filters**
- **Thermostats for passenger cars, vans, buses, and trucks**

- **Turbochargers for passenger cars, vans, buses, and trucks**
- **Alternators and starter motors for trucks and buses**
- **Alternators and starter motors for agricultural and construction machinery and other engines**
- **Electric motors**
- **A/C compressors**

The complete range of products can be found with just a few clicks at [www.mahle-aftermarket.com](http://www.mahle-aftermarket.com).

In addition, the data for the complete MAHLE Aftermarket product range is also available on TecDoc.



**The complete product range is also available on the Internet at [www.mahle-aftermarket.com](http://www.mahle-aftermarket.com)**

# SOMMAIRE

<b>Emballage</b>	10
<b>Utilisation du catalogue</b>	
Recommandations importantes	11
Autres catalogues	12
<b>Section produits</b>	37–90
<b>Liste comparative des constructeurs d'automobiles</b>	91–96

<b>DE</b>	<b>Zu diesem Katalog</b>	01–04
<b>EN</b>	<b>About this catalog</b>	05–08
<b>FR</b>	<b>Informations concernant ce catalogue</b>	09–12
<b>ES</b>	<b>Acerca de este catálogo</b>	13–16
<b>IT</b>	<b>Su questo catalogo</b>	17–20
<b>PL</b>	<b>Informacje o niniejszym katalogu</b>	21–24
<b>RU</b>	<b>Информация о каталоге</b>	25–28
<b>TR</b>	<b>Bu katalog hakkında</b>	29–32
<b>AR</b>	<b>حول هذا الكatalog</b>	36–33

# NOUVEAU DESIGN D'EMBALLAGE SIMPLE. CLAIR. CONVIVAL.

Les nouveaux emballages MAHLE Aftermarket offrent de nombreux avantages : des couleurs vives, des informations concises et un design convivial pour une manipulation aisée chez les distributeurs et dans les ateliers.

Nous n'avons pas modifié les étiquettes de sécurité MAHLE, afin qu'à l'avenir également vous puissiez continuer de reconnaître les emballages d'origine de façon fiable.

## VUE D'ENSEMBLE DE TOUTES LES MODIFICATIONS

### LES AVANTAGES DU NOUVEL EMBALLAGE

- 1 MAHLE Original devient MAHLE – pour plus de clarté
- 2 Des couleurs vives et pleines, pour une meilleure visibilité de loin ; presque tous les emballages sont bleus, même pour le refroidissement moteur et la climatisation BEHR (anciennement orange) et les pièces moteur MAHLE (anciennement rouge)
- 3 Un positionnement repensé et facile à lire de la désignation produit
- 4 Des illustrations supplémentaires pour identifier les produits
- 5 Des informations limitées à l'essentiel



Figure à titre de référence uniquement

# RECOMMANDATIONS IMPORTANTES

Les numéros de pièces d'origine des constructeurs automobiles et des motoristes ne sont fournis qu'à des fins de comparaison interne et ne constituent pas une appellation d'origine ou une désignation de provenance. À ce titre, ils ne peuvent être utilisés à l'endroit des propriétaires des véhicules.

La composition et l'impression de ce catalogue s'étalent sur plusieurs semaines. Il est donc probable que les dernières nouveautés n'y apparaissent pas. Il est également possible que le produit ait été modifié au cours de la production en série. Il est important de nous consulter ou de consulter notre partenaire de distribution.

Nos produits doivent être uniquement installés ou remplacés par du personnel spécialisé.

Les informations qui figurent dans ce catalogue sont traitées avec soin, nous déclinons toute responsabilité pour toute erreur éventuelle.

Cette réserve s'applique également si les désignations des moteurs et des modèles ainsi que les produits ont été modifiés par les constructeurs.

Ce catalogue annule et remplace les éditions préalables. Tous droits réservés. Toute reproduction, même partielle, est soumise à l'autorisation écrite préalable de MAHLE, sous peine de poursuites.

# AUTRES CATALOGUES

MAHLE AFTERMARKET PROPOSE LES CATALOGUES  
SUIVANTS :

- **Pistons, cylindres, ensembles**
- **Jeux de segments de pistons**
- **Coussinets**
- **Éléments composant la distribution**
- **Ligne classique MAHLE**
- **Filtres pour véhicules particuliers et utilitaires légers**
- **Filtres pour poids lourds, bus et utilitaires légers**
- **Filtres pour machines agricoles, engins de chantier et autres moteurs**
- **Filtres pour motos**
- **Liste comparative pour filtres**

- **Thermostats pour véhicules particuliers, utilitaires légers, bus et poids lourds**
- **Turbocompresseurs pour véhicules particuliers, utilitaires légers, bus et poids lourds**
- **Alternateurs et démarreurs pour camions et bus**
- **Alternateurs et démarreurs pour engins agricoles et de chantier et autres moteurs**
- **Moteurs électriques**
- **Compresseurs de climatisation**

Accédez à la gamme complète en quelques clics sur [www.mahle-aftermarket.com](http://www.mahle-aftermarket.com). Les données concernant la gamme complète des produits MAHLE Aftermarket sont également disponibles sur TecDoc.



La gamme complète est également consultable sur  
[notre site www.mahle-aftermarket.com](http://www.mahle-aftermarket.com)

# SUMARIO

<b>Embalaje</b>	14
<b>Uso del catálogo</b>	
<b>Informaciones importantes</b>	15
<b>Otros catálogos</b>	16
<b>Sección de productos</b>	37–90
<b>Lista comparativa de constructores de vehículos</b>	91–96

<b>DE</b>	<b>Zu diesem Katalog</b>	01–04
<b>EN</b>	<b>About this catalog</b>	05–08
<b>FR</b>	<b>Informations concernant ce catalogue</b>	09–12
<b>ES</b>	<b>Acerca de este catálogo</b>	13–16
<b>IT</b>	<b>Su questo catalogo</b>	17–20
<b>PL</b>	<b>Informacje o niniejszym katalogu</b>	21–24
<b>RU</b>	<b>Информация о каталоге</b>	25–28
<b>TR</b>	<b>Bu katalog hakkında</b>	29–32
<b>AR</b>	<b>حول هذا الكatalog</b>	36–33

# EL NUEVO DISEÑO DE EMBALAJE SIMPLE. CLARO. INTUITIVO.

Los nuevos embalajes de MAHLE Aftermarket ofrecen algunas ventajas: colores fuertes, información concisa y una configuración más intuitiva facilitan la manipulación tanto en el taller como en la distribución.

Lo que no ha variado son las etiquetas de seguridad de MAHLE, para que también en el futuro reconozca con fiabilidad los embalajes originales MAHLE.

## TODOS LOS CAMBIOS DE UN VISTAZO

### LAS VENTAJAS DE LOS NUEVOS EMBALAJES

- 1 MAHLE Original pasa a ser MAHLE, para una mayor claridad
- 2 Colores intensos de cobertura total para un fácil reconocimiento a distancia; casi todos los embalajes son azules, también para la refrigeración y la climatización de BEHR (hasta ahora, de color naranja) y para los componentes de motor MAHLE (hasta ahora, de color rojo)
- 3 Nueva ubicación de la referencia más fácil de leer
- 4 Ilustraciones auxiliares adicionales para los productos
- 5 Reducción de la información a lo esencial



La ilustración solo muestra un ejemplo



# INFORMACIONES IMPORTANTES

Los números de referencia de los constructores de vehículos y motores figuran únicamente para facilitar la comparación. No indican el origen de la pieza y no se pueden utilizar de cara a los propietarios de los vehículos.

La composición y la impresión de este catálogo se extienden a lo largo varias semanas. Por esta razón, puede no incluir los últimos productos aparecidos. También es posible que, mientras tanto, algún producto haya sufrido alguna modificación durante la producción en serie. Siempre es conveniente consultar con nosotros o con nuestros distribuidores.

Nuestros productos deberán ser montados exclusivamente por personal cualificado.

Los datos de este catálogo se han elaborado cuidadosamente, pero sin compromiso. No garantizamos la corrección de los datos.

A esta reserva también están sujetas las modificaciones de referencias del motor, del modelo y de los productos por parte de los fabricantes.

Con la publicación de este catálogo pierden su validez todas las ediciones anteriores. Reservados todos los derechos. Toda reproducción, incluso en forma de extracto, requiere nuestra previa autorización por escrito. El uso indebido será objeto de demanda judicial.

# OTROS CATÁLOGOS

MAHLE AFTERMARKET OFRECE LAS SIGUIENTES OBRAS DE CONSULTA:

- Pistones, cilindros, conjuntos
- Juegos de segmentos de pistón
- Cojinetes
- Componentes para accionamiento de válvulas
- Línea clásica MAHLE
- Filtros para turismos y vehículos de transporte
- Filtros para camiones, autobuses y vehículos de transporte
- Filtros para maquinaria agrícola y de construcción y para otros motores
- Filtros para motocicletas
- Lista comparativa de filtros
- Termostatos para turismos, vehículos de transporte, autobuses y camiones

- Turbocompresores para turismos, vehículos de transporte, autobuses y camiones
- Alternadores y motores de arranque para camiones y autobuses
- Alternadores y motores de arranque para maquinaria agrícola y de construcción y otros motores
- Motores eléctricos
- Compresores de aire acondicionado

Encontrará la gama completa de productos con unos clics en [www.mahle-aftermarket.com](http://www.mahle-aftermarket.com).

Además, toda la información sobre los productos de MAHLE Aftermarket también está disponible en TecDoc.



El programa completo también está disponible en internet en [www.mahle-aftermarket.com](http://www.mahle-aftermarket.com)

# PANORAMICA

<b>Confezione</b>	18
<b>Come utilizzare il catalogo</b>	
Avvertenze importanti	19
Altri cataloghi	20
<b>Sezione prodotti</b>	37–90
<b>Elenco comparativo costruttori automobili</b>	91–96

<b>DE</b>	<b>Zu diesem Katalog</b>	01–04
<b>EN</b>	<b>About this catalog</b>	05–08
<b>FR</b>	<b>Informations concernant ce catalogue</b>	09–12
<b>ES</b>	<b>Acerca de este catálogo</b>	13–16
<b>IT</b>	<b>Su questo catalogo</b>	17–20
<b>PL</b>	<b>Informacje o niniejszym katalogu</b>	21–24
<b>RU</b>	<b>Информация о каталоге</b>	25–28
<b>TR</b>	<b>Bu katalog hakkında</b>	29–32
<b>AR</b>	<b>حول هذا الكتلوج</b>	36–33

# NUOVO DESIGN DELLA CONFEZIONE SEMPLICE. CHIARA. TRASPARENTE.

Le nuove confezioni MAHLE Aftermarket offrono diversi vantaggi: colori intensi, informazioni essenziali e una maggiore trasparenza ne facilitano la gestione da parte di ricambisti e officine.

Le etichette di sicurezza MAHLE sono rimaste però invariate, così le confezioni originali MAHLE continueranno ad essere facilmente riconoscibili anche in futuro.

## TUTTE LE MODIFICHE IN SINTESI

### I VANTAGGI DELLE NUOVE CONFEZIONI

- 1 MAHLE Original diventa MAHLE: per una maggiore chiarezza
- 2 Colori intensi, su grandi superfici, per un migliore impatto visivo a distanza. Quasi tutte le confezioni sono blu, anche la linea per il raffreddamento e la climatizzazione di BEHR (finora arancione) e i componenti motore MAHLE (finora rossi)
- 3 Nuova posizione del nome del prodotto, più leggibile
- 4 Illustrazioni aggiuntive dei vari prodotti
- 5 Riduzione delle informazioni all'essenziale



Figura a solo titolo esemplificativo

# AVVERTENZE IMPORTANTI

I codici dei ricambi originali dei produttori di veicoli e motori servono solo a fini comparativi interni. Non rappresentano una denominazione d'origine e non devono essere utilizzati con i proprietari dei veicoli.

Per la stesura e la stampa di questo catalogo occorrono alcune settimane, motivo per cui le ultime novità potrebbero non essere state inserite. Allo stesso modo è possibile che un prodotto sia stato modificato durante la produzione di serie. In caso di dubbi, vi preghiamo di rivolgervi a noi o al nostro rappresentante.

I nostri prodotti possono essere montati e/o smontati solo da personale specializzato.

I dati di questo catalogo sono stati elaborati con la massima cura, ma non sono vincolanti.

Anche le modifiche delle denominazioni dei motori e delle tipologie da parte dei produttori nonché dei prodotti sono soggette a questa riserva.

Con la pubblicazione di questo catalogo, tutte le edizioni precedenti perdono di validità. Ci riserviamo tutti i diritti. Riproduzioni ed estratti sono ammessi soltanto previo nostro consenso scritto. Ogni abuso verrà perseguito penalmente.

# ALTRI CATALOGHI

DI MAHLE AFTERMARKET SONO DISPONIBILI I SEGUENTI CATALOGHI:

- Pistoni/canne cilindro/gruppi canna-pistone
- Kit anelli di tenuta
- Bronzine
- Componenti distribuzione
- Linea Classica MAHLE
- Filtri per autovetture e furgoni
- Filtri per furgoni, autocarri e autobus
- Filtri per mezzi agricoli, edili e motori stazionari
- Filtri per motociclette
- Lista comparativa dei filtri
- Termostati per autovetture, furgoni, autocarri e autobus

- Turbocompressori per autovetture, furgoni, autocarri e autobus
- Alternatori e motorini d'avviamento per mezzi pesanti e autobus
- Alternatori e motorini d'avviamento per mezzi agricoli, edili e motori stazionari
- Motori elettrici
- Compressori per climatizzatori

Il programma completo dei prodotti è disponibile all'indirizzo [www.mahle-aftermarket.com](http://www.mahle-aftermarket.com). Inoltre i dati relativi all'intera gamma di prodotti MAHLE Aftermarket sono disponibili anche su TecDoc.



L'assortimento completo è visualizzabile anche in internet all'indirizzo [www.mahle-aftermarket.com](http://www.mahle-aftermarket.com)

# PRZEGLĄD

<b>Opakowanie</b>	22
<b>Zastosowanie katalogu</b>	
Ważne wskazówki	23
Dodatkowe katalogi	24
<b>Część produktu</b>	37–90
<b>Lista porównawcza producentów pojazdów</b>	91–96

<b>DE</b>	<b>Zu diesem Katalog</b>	01–04
<b>EN</b>	<b>About this catalog</b>	05–08
<b>FR</b>	<b>Informations concernant ce catalogue</b>	09–12
<b>ES</b>	<b>Acerca de este catálogo</b>	13–16
<b>IT</b>	<b>Su questo catalogo</b>	17–20
<b>PL</b>	<b>Informacje o niniejszym katalogu</b>	21–24
<b>RU</b>	<b>Информация о каталоге</b>	25–28
<b>TR</b>	<b>Bu katalog hakkında</b>	29–32
<b>AR</b>	<b>حول هذا الكatalog</b>	36–33

# NOWY DESIGN OPAKOWAŃ PROSTY. PRZEJRZYSTY. KOMPAKTOWY.

Nowe opakowania MAHLE Aftermarket oferują wiele zalet: wyraźne kolory, najważniejsze informacje oraz przejrzysty design ułatwią transport i identyfikację w handlu i w warsztacie.

Etykieta zabezpieczająca MAHLE pozostanie niezmienną – dzięki niej zawsze będziesz mieć pewność, że trzymasz w ręku oryginalne opakowanie MAHLE.

## PRZEGLĄD MODYFIKACJI

### ZALETY NOWYCH OPAKOWAŃ

- 1 MAHLE Original skrócono do jednego słowa: MAHLE – dla lepszej przejrzystości
- 2 Żywe kolory na dużej części opakowania w celu skuteczniejszej identyfikacji z odległości; niemal wszystkie opakowania są niebieskie – również sprzęt do chłodzenia i klimatyzacji marki BEHR (dotychczas w kolorze pomarańczowym) oraz części silnikowe MAHLE (dotychczas w kolorze czerwonym)
- 3 Nowa, łatwa do odczytania nazwa produktu
- 4 Dodatkowe, pomocnicze ilustracje produktów
- 5 Ograniczenie zakresu informacji do najbardziej istotnych



Ilustracja poglądowa



# WAŻNE WSKAZÓWKI

Oryginalne numery części zamiennych producentów pojazdów i silników służą tylko do wewnętrznych celów porównawczych. Nie są one oznaczeniami pochodzenia i ze względów prawa ochrony konkurencji nie można ich stosować wobec posiadaczy pojazdów.

Proces zestawiania i druku niniejszego katalogu trwa kilka tygodni. Z tego względu najnowsze pozycje mogą być tu nieuwzględnione. Mogła także wystąpić zmiana produktu w trakcie produkcji seryjnej. Dlatego zawsze celowym jest zasięgnięcie porady u naszych partnerów dystrybucyjnych.

Nasze produkty mogą być montowane wyłącznie przez specjalistyczny personel.

Dane w niniejszym katalogu zostały opracowane z dużą starannością, jednak nie udzielamy gwarancji na ich prawidłowość.

Zastrzeżona jest również możliwość zmian oznaczeń silników i typów, a także zmian produktów przez producentów.

Z chwilą opublikowania niniejszego katalogu tracą ważność wszystkie wcześniejsze wydania. Wszystkie prawa zastrzeżone. Powielanie i publikowanie także fragmentów jest dozwolone wyłącznie po uzyskaniu naszej pisemnej zgody. Nadużycia będą ścigane.

# DODATKOWE KATALOGI

NASTĘPUJĄCE KATALOGI SĄ OBECNIE DOSTĘPNE  
W MAHLE AFTERMARKET:

- Tłoki, cylindry, zestawy
- Zestawy pierścieni tłokowych
- Łożyska ślizgowe
- Podzespoły układów rozrządu
- Klasyczna linia MAHLE
- Filtry do samochodów osobowych i dostawczych
- Filtry do pojazdów ciężarowych, autobusów i pojazdów dostawczych
- Filtry do maszyn rolniczych i budowlanych oraz innych silników
- Filtry do motocykli
- Lista porównawcza filtrów
- Termostaty do samochodów osobowych, transporterów, autobusów i samochodów ciężarowych

- Turbosprężarki do samochodów osobowych, transporterów, autobusów i samochodów ciężarowych
- Alternatory i rozruszniki do pojazdów ciężarowych i autobusów
- Alternatory i rozruszniki do maszyn rolniczych i budowlanych oraz do innych silników
- Silniki elektryczne
- Kompresory klimatyzacji

Kompletny asortyment produktów jest dostępny w naszym katalogu online na stronie [www.mahle-aftermarket.com](http://www.mahle-aftermarket.com). Ponadto dane całej gamy produktów MAHLE Aftermarket dostępne są również w postaci TecDoc.



**Kompletny asortyment jest dostępny również w internecie pod adresem [www.mahle-aftermarket.com](http://www.mahle-aftermarket.com)**

# ОБЗОР

<b>Упаковка</b>	26
<b>Как пользоваться каталогом</b>	
Важные указания	27
Прочие каталоги	28
<b>Продукция</b>	37–90
<b>Сравнительный список производителей автомобилей</b>	91–96

<b>DE</b>	<b>Zu diesem Katalog</b>	01–04
<b>EN</b>	<b>About this catalog</b>	05–08
<b>FR</b>	<b>Informations concernant ce catalogue</b>	09–12
<b>ES</b>	<b>Acerca de este catálogo</b>	13–16
<b>IT</b>	<b>Su questo catalogo</b>	17–20
<b>PL</b>	<b>Informacje o niniejszym katalogu</b>	21–24
<b>RU</b>	<b>Информация о каталоге</b>	25–28
<b>TR</b>	<b>Bu katalog hakkında</b>	29–32
<b>AR</b>	<b>حول هذا الكatalog</b>	36–33

# НОВЫЙ ДИЗАЙН УПАКОВКИ ПРОСТО. ЯСНО. НАГЛЯДНО.

У нового дизайна упаковок MAHLE Aftermarket несколько сильных преимуществ: более яркие цвета, наглядная информация и понятный дизайн, что упростит операции с товаром в торговых и автосервисных предприятиях.

Неизменной осталась защитная этикетка безопасности MAHLE для безошибочной идентификации оригинальных упаковок MAHLE.

## ОБЗОР ВСЕХ ИЗМЕНЕНИЙ

### ПРЕИМУЩЕСТВА НОВЫХ УПАКОВОК

- 1 MAHLE Original превращается в MAHLE — больше ясности
- 2 Яркие цвета по всей поверхности способствуют лучшей узнаваемости продукции издалека; почти все упаковки выполнены в синем цвете — в том числе упаковки систем охлаждения и кондиционирования VENTR (прежний цвет: оранжевый), а также деталей для двигателей MAHLE (прежний цвет: красный)
- 3 Новое удобное расположение наименования продукта
- 4 Дополнительные информативные символы для описания продукта
- 5 Сокращение объема информации с фокусом на самое нужное



Примерный эскиз

## ВАЖНЫЕ УКАЗАНИЯ

Номера оригинальных запасных частей производителей автомобилей и двигателей приведены только для внутреннего пользования при сравнении. Они не указывают на происхождение товара и не могут использоваться при общении с владельцами транспортных средств.

Составление и печать данного каталога занимает несколько недель. В результате этого в нем могут отсутствовать самые последние новинки. Также возможно изменение продукта в рамках серийного производства. Поэтому мы рекомендуем всегда связываться с нами или нашим дистрибьютором.

Монтаж наших продуктов должен производить только обученный персонал.

Данные в этом каталоге были тщательно проверены. Тем не менее, мы не несем ответственность за правильность данных.

Это же положение распространяется на изменения маркировки двигателей и моделей, а также самих продуктов производителем.

После выхода настоящего каталога предыдущие выпуски каталога становятся недействительными. Мы оставляем за собой все права. Частичная или полная перепечатка допускается только с предварительного письменного согласия. Нарушения преследуются по закону.

## ПРОЧИЕ КАТАЛОГИ

### В MAHLE AFTERMARKET ИМЕЮТСЯ СЛЕДУЮЩИЕ СПРАВОЧНЫЕ МАТЕРИАЛЫ:

- Поршни/цилиндры/детали двигателя
- Наборы поршневых колец
- Подшипники скольжения
- Компоненты клапанного механизма
- Классическая линейка MAHLE
- Фильтры для легковых автомобилей и грузовых автомобилей малой грузоподъемности
- Фильтры для грузовых автомобилей, автобусов и грузовых автомобилей малой грузоподъемности
- Фильтры для сельскохозяйственных и строительных машин, а также других двигателей
- Фильтры для мотоциклов
- Сравнительный обзор фильтров
- Термостаты для легковых автомобилей, грузовых автомобилей малой грузоподъемности, автобусов и грузовых автомобилей

- Турбонагнетатели для легковых автомобилей, грузовых автомобилей малой грузоподъемности, автобусов и грузовых автомобилей
- Генераторы и стартеры для грузовых автомобилей и автобусов
- Генераторы для сельскохозяйственных и строительных машин, а также других двигателей
- Электромоторы
- воздушные компрессоры

Полный ассортимент можно найти на сайте [www.mahle-aftermarket.com](http://www.mahle-aftermarket.com). Кроме того, все продукты MAHLE Aftermarket имеются в электронном каталоге TecDoc.



**Весь ассортимент можно посмотреть в Интернете по адресу [www.mahle-aftermarket.com](http://www.mahle-aftermarket.com)**

# GENEL BAKIŞ

<b>Ambalaj</b>	30
<b>Katalog uygulaması</b>	
Önemli uyarılar	31
Diğer kataloglar	32
<b>Ürün kısmı</b>	37-90
<b>Otomotiv üreticileri karşılaştırma listesi</b>	91-96

<b>DE</b>	<b>Zu diesem Katalog</b>	01-04
<b>EN</b>	<b>About this catalog</b>	05-08
<b>FR</b>	<b>Informations concernant ce catalogue</b>	09-12
<b>ES</b>	<b>Acerca de este catálogo</b>	13-16
<b>IT</b>	<b>Su questo catalogo</b>	17-20
<b>PL</b>	<b>Informacje o niniejszym katalogu</b>	21-24
<b>RU</b>	<b>Информация о каталоге</b>	25-28
<b>TR</b>	<b>Bu katalog hakkında</b>	29-32
<b>AR</b>	<b>حول هذا الكatalog</b>	36-33

# YENİ AMBALAJ TASARIMI BASİT. NET. ANLAŞILIR.

Yeni MAHLE Aftermarket ambalajları, bir dizi avantaj sunmaktadır: Güçlü renkler, kısa ve kesin bilgiler ve belirgin bir tasarım, bayilerde ve araç servislerinde kullanımı kolaylaştırıyor.

MAHLE orijinal ambalajlarını gelecekte de güvenli bir şekilde tanıyabilmeniz için, MAHLE güvenlik etiketlerini değiştirmedik.

## TÜM DEĞİŞİKLİKLERE GENEL BAKIŞ

### YENİ AMBALAJLARIN AVANTAJLARI

- 1 MAHLE Original artık MAHLE olacak – daha anlaşılır olması için
- 2 Uzaktan daha etkili olması için, güçlü ve tam yüzeyli renkler; BEHR'in soğutma ve iklimlendirme sistemleri (önceden turuncu) ve MAHLE motor parçaları (önceden kırmızı) dahil olmak üzere, neredeyse tüm ambalajlar artık mavi renkli
- 3 Ürün adının yeni ve kolay okunabilen bir şekilde yerleştirilmesi
- 4 Ürünler için ek olarak destekleyici resimler
- 5 Bilginin önemli noktaları içerecek şekilde azaltılması



Görsel, sadece örnek niteliğindedir



# ÖNEMLİ UYARILAR

Araç ve motor üreticilerinin orijinal yedek parça numaraları, sistem içi karşılaştırma amacına hizmet etmektedir. Bu numaralar, menşe işaretleri değildir ve araç sahiplerine karşı kullanılmamalıdır.

Bu kataloğun düzenlemesi ve basımı birkaç hafta sürecektir. Bundan dolayı, en son girişler muhtemelen kaydedilemeyecektir. Aynı şekilde bir ürün, seri üretim sırasında değişikliğe uğramış olabilir. Esas itibarıyla, bu konuda bize veya satış ortaklarımıza danışmanızı tavsiye ederiz.

Ürünlerimiz, yalnızca eğitimli uzman personel tarafından monte edilmelidir.

Bu katalogdaki veriler özenle hazırlanmıştır. Ancak, söz konusu verilerin doğruluğu konusunda herhangi bir sorumluluk kabul etmemekteyiz.

Üretici firma tarafından gerçekleştirilebilecek motor ve model tanımları ile üründeki bir değişiklik, yine bu hükme tabidir.

Bu kataloğun yayınlanması ile birlikte daha önceki baskılar geçerliliğini yitirir. Tüm haklarımızı saklı tutmaktayız. Yapılacak kopya ve alıntılara, yalnızca daha önce bizden alınacak yazılı onay ile izin verilir. Herhangi bir suistimal durumunda yasal yollara başvurulacaktır.

# DİĞER KATALOGLAR

## AŞAĞIDAKİ KATALOGLAR MAHLE AFTERMARKET'TEN TEMİN EDİLEBİLİR:

- Pistonlar/Silindirler/Kitler
- Piston segman setleri
- Kayar yataklar
- Supap bileşenleri
- MAHLE Klasik Seri
- Binek araçlar ve transporterler için filtreler
- Kamyonlar, otobüsler ve transporterler için filtreler
- Tarım ve iş makineleri ve diğer motorlar için filtreler
- Motosikletler için filtreler
- Filtre karşılaştırma listesi
- Binek araçlar, transporterler, otobüsler ve kamyonlar için termostatlar

- Binek araçlar, transporterler, otobüsler ve kamyonlar için turboşarjlar
- Kamyonlar ve otobüsler için alternatörler ve marş motorları
- Tarım ve iş makineleri ile diğer motorlar için alternatörler ve marş motorları
- Elektrik motorları
- Klima kompresörleri

Tüm ürün yelpazesine birkaç tıklama ile [www.mahle-aftermarket.com](http://www.mahle-aftermarket.com) adresinden ulaşabilirsiniz. Ayrıca, MAHLE Aftermarket ürün yelpazesi ile ilgili tüm veriler TecDoc üzerinden de temin edilebilir.

**Tüm ürün programına internet üzerinden de ulaşabilirsiniz: [www.mahle-aftermarket.com](http://www.mahle-aftermarket.com)**



## كتالوجات أخرى

- ← منظمات الحرارة لسيارات الركاب، والناقلات، والحافلات، والشاحنات
- ← الشواحن التوربينية لسيارات الركاب، والناقلات، والحافلات، والشاحنات
- ← المولدات ومحركات التشغيل للشاحنات والحافلات
- ← المولدات ومحركات التشغيل للآلات الزراعية والإنشائية والمحركات الأخرى
- ← المحركات الكهربائية
- ← ضواغط الهواء

إضافة لهذا الكتالوج، يقدم قسم خدمات ما بعد البيع من MAHLE المراجع التالية:

- ← المكابس/الأسطوانات/المجموعات التركيبية
- ← مجموعات طوق المكبس
- ← المحامل الانزلاقية
- ← مكونات نظام إدارة الصمامات
- ← مجموعة MAHLE الكلاسيكية
- ← فلتر سيارات الركاب والناقلات
- ← فلتر الشاحنات، والحافلات، والناقلات
- ← فلتر الآلات الزراعية والإنشائية والمحركات الأخرى
- ← فلتر الدراجات النارية
- ← قائمة المقارنة للفلاتر

يمكنك الوصول إلى مجموعة المنتجات بالكامل بنقرات بسيطة على موقعنا الإلكتروني [www.mahle-aftermarket.com](http://www.mahle-aftermarket.com). كما تتوفر أيضاً البيانات الخاصة بمجموعة منتجات خدمة ما بعد البيع من MAHLE على نظام المعلومات TecDoc.



تتوفر المجموعة بالكامل أيضاً على موقعنا الإلكتروني على شبكة الإنترنت  
[www.mahle-aftermarket.com](http://www.mahle-aftermarket.com)

## إيضاحات

البيانات الموجودة في هذا الكتالوج تم تحريرها بدقة. ولا تتحمل أي ضمان تجاه صحة هذه البيانات.

وبنفس القدر فإن حدوث تغييرات في تسميات المحركات والطرازات من قبل منتجها وكذلك في المنتجات يكون خاضعاً لهذا التحفظ.

مع ظهور ونشر هذا الكتالوج فإن كافة البيانات السابقة له تصبح لاغية وتفقد صلاحيتها. ونحن نحفظ لأنفسنا بكافة الحقوق. إعادة الطبع وأخذ مستخرجات أو مقتطفات من الكتالوج لا يكون مسموحاً به إلا بعد الحصول مسبقاً على موافقة كتابية من قبلنا. الانتهاكات سوف يتم تعقبها قانونياً.

أرقام قطع الغيار الأصلية الخاصة بصانعي السيارات والمحركات يتم استخدامها فقط لأغراض المقارنة الداخلية. وهي ليست بتسمية مصدر أو منشأ ولا يسمح باستخدامها في مواجهة مالكي السيارات.

يستغرق إعداد بيانات وطباعة هذا الكتالوج عدة أسابيع. نتيجة لذلك فإن بيانات المنتجات المستجدة لا يكون من الممكن احتوائها في القائمة. ولكن من الممكن أن يتم تعديل المنتج أثناء إنتاج الطراز. وبناءً عليه يتم الرجوع إلينا أو إلى شريك التوزيع التابع لنا.

يجب عدم تركيب أو فك المنتج الخاص بنا إلا من قبل فني خبير بذلك.

## تصميم جديد للعبوات بسيط.. واضح.. ومباشر.

ولكننا لم نقدم على تغيير ملصقات أمان MAHLE، كي يمكنك التعرف بثقة على عبوات MAHLE الأصلية في المستقبل أيضًا.

توفر عبوات MAHLE Aftermarket الجديدة العديد من المزايا: ألوان قوية، معلومات موجزة، وتصميم أكثر وضوحًا، من أجل سهولة المناولة والتعامل سواء في متاجر البيع أو داخل الورش.

## جميع التغييرات في لمحة

### مزايا العبوات الجديدة



الصورة مثال توضيحي فقط

1 MAHLE Original أصبحت MAHLE فقط - من أجل وضوح أكبر

2 ألوان قوية ومسطحة بالكامل لتأثير أوضح عن بعد. كل العبوات تقريبًا أصبحت باللون الأزرق - وأيضًا عبوات التبريد وتكييف الهواء من BEHR (برتقالي سابقًا) وأجزاء المحرك من MAHLE (أحمر سابقًا)

3 وضع اسم المنتج في مكان جديد وأوضح للعميل

4 رسوم توضيحية إضافية للمنتجات

5 تقليل المعلومات إلى الأساسي منها فقط

## نظرة عامة











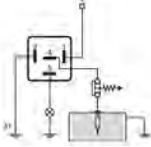

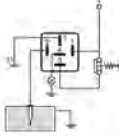

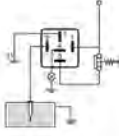
35	العبوات
	استخدام الكتالوج
34	إيضاحات
33	كتالوجات أخرى
90-37	أجزاء المنتج
96-91	قائمة مقارنة بين شركات تصنيع السيارات

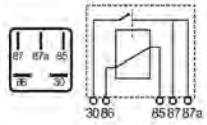

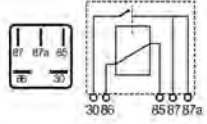

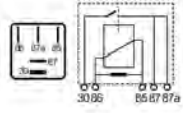

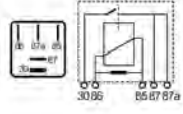



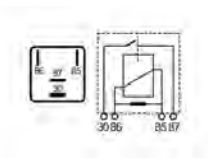

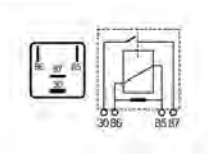
01-04  
05-08  
09-12  
13-16  
17-20  
21-24  
25-28  
29-32  
33-36

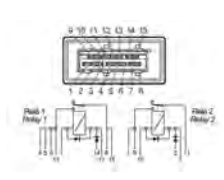
Zu diesem Katalog  
About this catalog  
Informations concernant ce catalogue  
Acerca de este catálogo  
Su questo catalogo  
Informacje o niniejszym katalogu  
Информация о каталоге  
Bu katalog hakkında

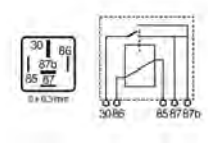

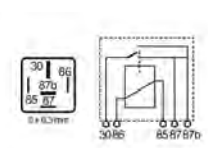

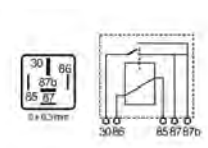



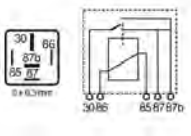

حول هذا الكتالوج

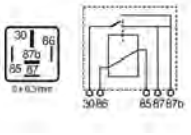

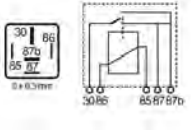

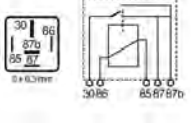

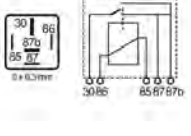



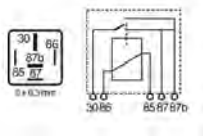
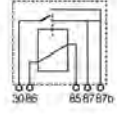

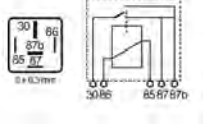
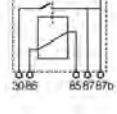
DE  
EN  
FR  
ES  
IT  
PL  
RU  
TR  
AR

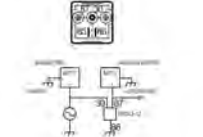
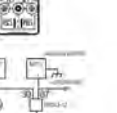

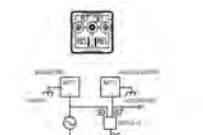
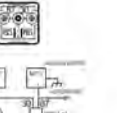

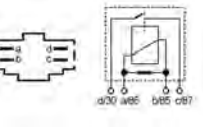
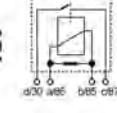

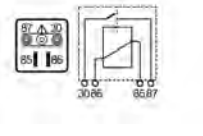
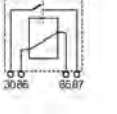



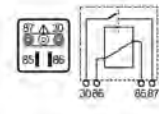

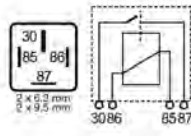
	Rated Voltage [V]	Rated Power [W]	Operating Current [A]	Rest current [A]	Number of Poles	Notes
<b>ME 4</b>	12	5W Max	-	-	4	-
Relay, main current						
<b>ME 5</b>	12	5W Max	-	-	5	-
Relay, main current						
<b>ME 6</b>	24	5W Max	-	-	5	-
Relay, main current						
<b>MR 1</b>	12	-	25	-	5	Micro Relay / with resistance
Relay, main current						
<b>MR 2</b>	24	-	10	-	5	Micro Relay / with resistance
Relay, main current						
<b>MR 3</b>	12	-	20	10	5	with resistance / Micro Relay
Relay, main current						
<b>MR 4</b>	24	-	15	6	5	Micro Relay / with resistance
Relay, main current						

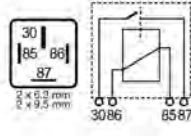

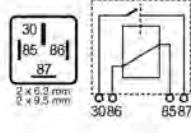

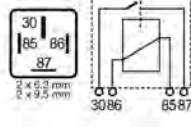

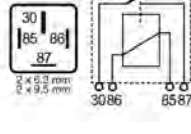



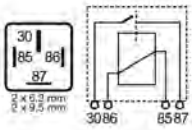

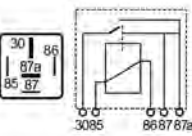
	Rated Voltage [V]	Rated Power [W]	Operating Current [A]	Rest current [A]	Number of Poles	Notes
<b>MR 5</b>	12	-	22	-	4	Micro Relay / with resistance
<b>Relay, main current</b>						
<b>MR 6</b>	24	-	15	-	4	Micro Relay / with resistance
<b>Relay, main current</b>						
<b>MR 7</b>	12	-	30	-	15	with diode
<b>Multifunctional relay</b>						
<b>MR 8</b>	12	-	-	-	5	2*20A / Fan, heater/air conditioning / Windscreen wiper / Rear window wiper / Horn / Heated rear window / Window Regulator / Low Beam
<b>Relay, main current</b>						
<b>MR 9</b>	12	-	-	-	5	2*20A / Window Regulator / Heated rear window / Windscreen wiper / Low Beam / Horn / Rear window wiper / Fan, heater/air conditioning / with diode
<b>Relay, main current</b>						
<b>MR 10</b>	12	-	-	-	5	2*20A / Rear window wiper / Fan, heater/air conditioning / Window Regulator / Heated rear window / Windscreen wiper / Low Beam / Horn / with resistance
<b>Relay, main current</b>						

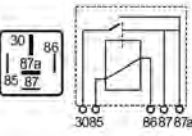

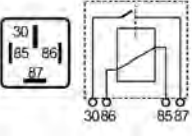

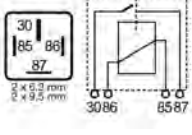

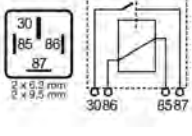



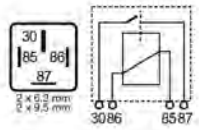
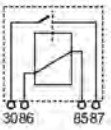

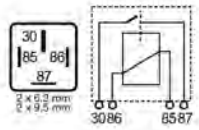
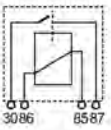

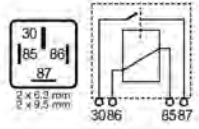
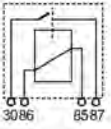

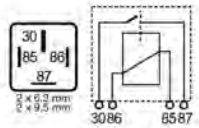
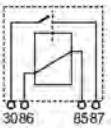

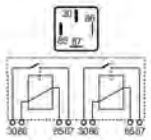
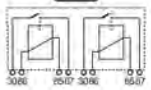

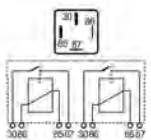
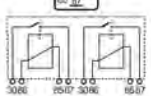



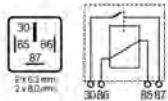

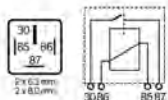
	Rated Voltage [V]	Rated Power [W]	Operating Current [A]	Rest current [A]	Number of Poles	Notes
MR 11 Relay, main current	24	-	-	-	5	2*10A / Fan, heater/air conditioning / Rear window wiper / Windscreen wiper / Heated rear window / Horn / Low Beam / Window Regulator
						
MR 12 Relay, main current	24	-	-	-	5	2*10A / Low Beam / Horn / Window Regulator / Rear window wiper / Fan heater/air conditioning / Heated rear window / Windscreen wiper / with diode
						
MR 13 Relay, main current	24	-	-	-	5	2*10A / Low Beam / Horn / Window Regulator / Rear window wiper / Fan heater/air conditioning / Heated rear window / Windscreen wiper / with resistance
						
MR 14 Relay, main current	12	-	-	-	5	2*20A / Horn / Heated rear window / Window Regulator / Low Beam / Fan heater/air conditioning / Windscreen wiper / Rear window wiper
						
MR 15 Relay, main current	12	-	-	-	5	2*20A / Heated rear window / Windscreen wiper / Low Beam / Horn / Rear window wiper / Fan, heater/air conditioning / Window Regulator / with resistance
						

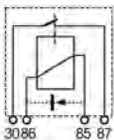

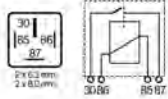

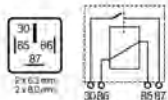

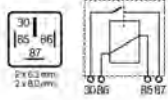



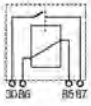

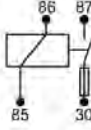
	Rated Voltage [V]	Rated Power [W]	Operating Current [A]	Rest current [A]	Number of Poles	Notes
MR 16 Relay, main current	24	-	-	-	5	2*10A / Window Regulator / Low Beam / Windscreen wiper / Rear window wiper / Horn / Heated rear window / Fan, heater/air conditioning
						
MR 17 Relay, main current	24	-	-	-	5	2*10A / Rear window wiper / Fan, heater/air conditioning / Heated rear window / Windscreen wiper / Low Beam / Horn / Window Regulator / with diode
						
MR 18 Relay, main current	12	-	100	-	4	-
						
MR 19 Relay, main current	24	-	60	-	4	-
						
MR 20 Multifunctional relay	12	-	20	-	4	with resistance
						
MR 24 Relay, window lift	12	-	100	-	4	-
						

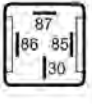
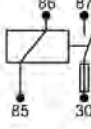

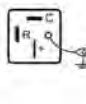
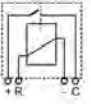

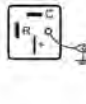
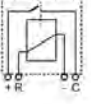

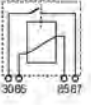

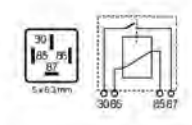

	Rated Voltage [V]	Rated Power [W]	Operating Current [A]	Rest current [A]	Number of Poles	Notes
MR 25	24	-	60	-	4	-
Relay, main current						
MR 26	12	-	70	-	4	Windscreen wiper / Rear window wiper / Horn / Heated rear window / Fan, heater/air conditioning / Window Regulator / Low Beam
Relay, main current						
MR 27	12	-	70	-	4	Low Beam / Horn / Window Regulator / Rear window wiper / Fan heater/air conditioning / Heated rear window / Windscreen wiper / with diode
Relay, main current						
MR 28	12	-	70	-	4	Rear window wiper / Fan, heater/air conditioning / Heated rear window / Windscreen wiper / Low Beam / Horn / Window Regulator / with resistance
Relay, main current						
MR 29	24	-	40	-	4	Horn / Heated rear window / Window Regulator / Low Beam / Fan, heater/air conditioning / Windscreen wiper / Rear window wiper
Relay, main current						
MR 30	24	-	40	-	4	Rear window wiper / Fan, heater/air conditioning / Window Regulator / Heated rear window / Windscreen wiper / Low Beam / Horn / with diode
Relay, main current						

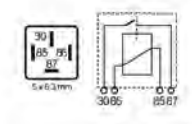
	Rated Voltage [V]	Rated Power [W]	Operating Current [A]	Rest current [A]	Number of Poles	Notes
<b>MR 31</b>  Relay, main current	24	-	40	-	4	Window Regulator / Heated rear window / Windscreen wiper / Low Beam / Horn / Rear window wiper / Fan, heater/air conditioning / with resistance
						
<b>MR 32</b>  Relay, main current	12	-	70	-	5	-
						
<b>MR 33</b>  Relay, main current	24	-	40	-	5	-
						
<b>MR 34</b>  Relay, main current	24	-	70	-	4	-
						
<b>MR 35</b>  Relay, main current	12	-	70	-	4	Window Regulator / Low Beam / Windscreen wiper / Rear window wiper / Horn / Heated rear window / Fan, heater/air conditioning
						
<b>MR 36</b>  Relay, main current	12	-	70	-	4	Low Beam / Horn / Window Regulator / Rear window wiper / Fan heater/air conditioning / Heated rear window / Windscreen wiper / with diode
						

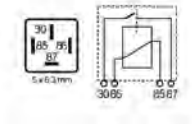

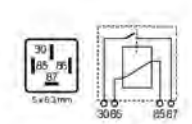

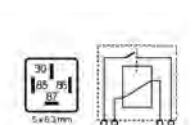



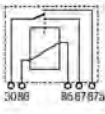

	Rated Voltage [V]	Rated Power [W]	Operating Current [A]	Rest current [A]	Number of Poles	Notes
MR 37 Relay, main current	12	-	70	-	4	Low Beam / Horn / Window Regulator / Rear window wiper / Fan heater/air conditioning / Heated rear window / Windscreen wiper / with resistance
						
MR 38 Relay, main current	24	-	40	-	4	Horn / Heated rear window / Window Regulator / Low Beam / Fan, heater/air conditioning / Windscreen wiper / Rear window wiper
						
MR 39 Relay, main current	24	-	40	-	4	Heated rear window / Windscreen wiper / Low Beam / Horn / Rear window wiper / Fan, heater/air conditioning / Window Regulator / with diode
						
MR 40 Relay, main current	24	-	40	-	4	Window Regulator / Heated rear window / Windscreen wiper / Low Beam / Horn / Rear window wiper / Fan, heater/air conditioning / with resistance
						
MR 41 Relay, main current	12	-	-	-	-	2*40A
						
MR 42 Relay, main current	24	-	-	-	-	2*22A
						

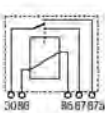

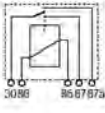

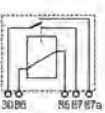

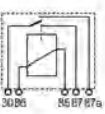

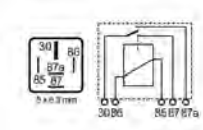

	Rated Voltage [V]	Rated Power [W]	Operating Current [A]	Rest current [A]	Number of Poles	Notes
<b>MR 43</b>  Relay, main current	12	-	50	-	4	Fan, heater/air conditioning / Window Regulator / Low Beam / Windscreen wiper / Rear window wiper / Horn / Heated rear window
						
<b>MR 44</b>  Relay, main current	12	-	50	-	4	Low Beam / Horn / Window Regulator / Rear window wiper / Fan heater/air conditioning / Heated rear window / Windscreen wiper / with diode
						
<b>MR 45</b>  Multifunctional relay	12	-	50	-	4	with diode
						
<b>MR 46</b>  Relay, main current	12	-	50	-	4	Window Regulator / Heated rear window / Windscreen wiper / Low Beam / Horn / Rear window wiper / Fan, heater/air conditioning / with resistance
						
<b>MR 47</b>  Relay, main current	24	-	30	-	4	Fan, heater/air conditioning / Window Regulator / Low Beam / Windscreen wiper / Rear window wiper / Horn / Heated rear window
						
<b>MR 48</b>  Relay, main current	12	-	50	-	4	Horn / Heated rear window / Window Regulator / Low Beam / Fan, heater/air conditioning / Windscreen wiper / Rear window wiper
						

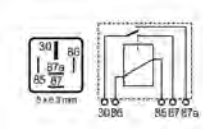

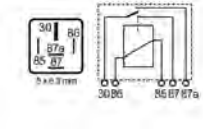

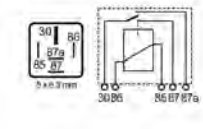

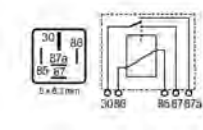

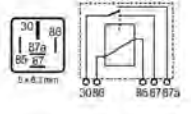

	Rated Voltage [V]	Rated Power [W]	Operating Current [A]	Rest current [A]	Number of Poles	Notes
MR 49 Relay, main current	12	-	50	-	4	Window Regulator / Heated rear window / Windscreen wiper / Low Beam / Horn / Rear window wiper / Fan, heater/air conditioning / with diode
						
MR 50 Relay, main current	12	-	15	-	4	-
						
MR 51 Relay, main current	12	-	15	-	4	-
						
MR 52 Relay, main current	12	-	40	-	3	-
						
MR 53 Relay, main current	24	-	22	-	3	-
						
MR 54 Relay, main current	12	-	40	-	4	Low Beam / Window Regulator / Heated rear window / Horn / Rear window wiper / Windscreen wiper / Fan, heater/air conditioning
						

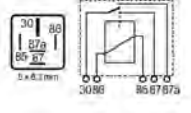

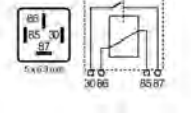







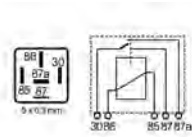

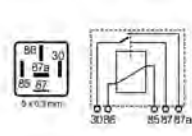
	Rated Voltage [V]	Rated Power [W]	Operating Current [A]	Rest current [A]	Number of Poles	Notes
<b>MR 55</b>  Relay, main current	12	-	40	-	4	Windscreen wiper / Heated rear window / Fan, heater/air conditioning / Rear window wiper / Window Regulator / Horn / Low Beam / with diode
						
<b>MR 56</b>  Relay, main current	12	-	40	-	4	Window Regulator / Horn / Low Beam / Windscreen wiper / Heated rear window / Fan, heater/air conditioning / Rear window wiper / with resistance
						
<b>MR 57</b>  Relay, main current	24	-	22	-	4	Rear window wiper / Windscreen wiper / Fan, heater/air conditioning / Low Beam / Window Regulator / Heated rear window / Horn
						
<b>MR 58</b>  Relay, main current	24	-	22	-	4	Window Regulator / Horn / Low Beam / Windscreen wiper / Heated rear window / Fan, heater/air conditioning / Rear window wiper / with diode
						
<b>MR 59</b>  Relay, main current	24	-	22	-	4	Fan, heater/air conditioning / Rear window wiper / Window Regulator / Horn / Low Beam / Windscreen wiper / Heated rear window / with resistance
						

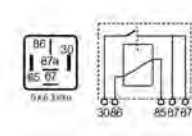



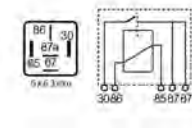

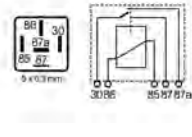



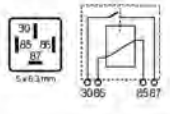

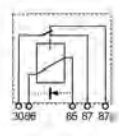

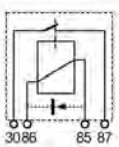

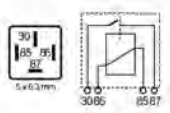

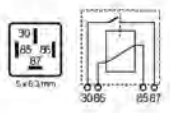

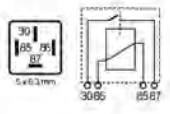

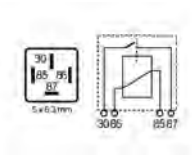

	Rated Voltage [V]	Rated Power [W]	Operating Current [A]	Rest current [A]	Number of Poles	Notes
MR 60 Relay, main current	12	-	40	-	5	Low Beam / Window Regulator / Heated rear window / Horn / Rear window wiper / Windscreen wiper / Fan, heater/air conditioning
	 					
MR 61 Relay, main current	12	-	40	-	5	Window Regulator / Horn / Low Beam / Windscreen wiper / Heated rear window / Fan, heater/air conditioning / Rear window wiper / with diode
	 					
MR 62 Relay, main current	12	-	40	-	5	Window Regulator / Horn / Low Beam / Windscreen wiper / Heated rear window / Fan, heater/air conditioning / Rear window wiper / with resistance
	 					
MR 63 Relay, main current	12	-	40	15	5	Fan, heater/air conditioning / Rear window wiper / Windscreen wiper / Heated rear window / Horn / Low Beam / Window Regulator
	 					
MR 64 Relay, main current	12	-	40	15	5	Fan, heater/air conditioning / Rear window wiper / Windscreen wiper / Heated rear window / Horn / Low Beam / Window Regulator / with diode
	 					

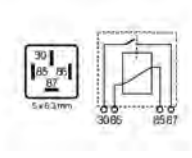

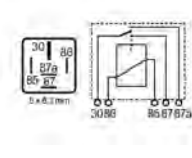

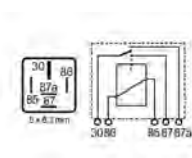

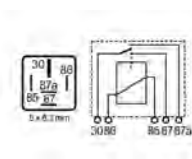

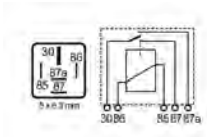

	Rated Voltage [V]	Rated Power [W]	Operating Current [A]	Rest current [A]	Number of Poles	Notes
<b>MR 65</b>  Relay, main current	12	-	40	15	5	Fan, heater/air conditioning / Rear window wiper / Windscreen wiper / Heated rear window / Horn / Low Beam / Window Regulator / with resistance
						
<b>MR 66</b>  Relay, main current	24	-	22	10	5	Fan, heater/air conditioning / Rear window wiper / Windscreen wiper / Heated rear window / Horn / Low Beam / Window Regulator
						
<b>MR 67</b>  Relay, main current	24	-	22	10	5	Fan, heater/air conditioning / Rear window wiper / Windscreen wiper / Heated rear window / Horn / Low Beam / Window Regulator / with diode
						
<b>MR 68</b>  Relay, main current	24	-	22	10	5	Fan, heater/air conditioning / Rear window wiper / Windscreen wiper / Heated rear window / Horn / Low Beam / Window Regulator / with resistance
						
<b>MR 69</b>  Relay, main current	24	-	22	-	5	Low Beam / Window Regulator / Heated rear window / Horn / Rear window wiper / Windscreen wiper / Fan, heater/air conditioning
						

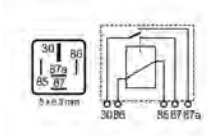

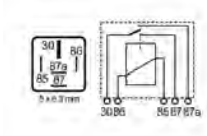

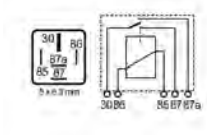

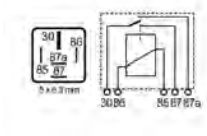



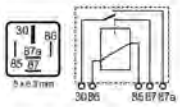

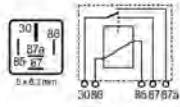
	Rated Voltage [V]	Rated Power [W]	Operating Current [A]	Rest current [A]	Number of Poles	Notes
MR 70 Relay, main current	24	-	22	-	5	Horn / Low Beam / Windscreen wiper / Heated rear window / Fan, heater/air conditioning / Rear window wiper / Window Regulator / with diode
						
MR 71 Relay, main current	24	-	22	-	5	Window Regulator / Horn / Low Beam / Windscreen wiper / Heated rear window / Fan, heater/air conditioning / Rear window wiper / with resistance
						
MR 72 Relay, main current	12	-	40	-	4	Low Beam / Window Regulator / Heated rear window / Horn / Rear window wiper / Windscreen wiper / Fan, heater/air conditioning
						
MR 73 Relay, main current	24	-	22	-	4	Rear window wiper / Windscreen wiper / Fan, heater/air conditioning / Low Beam / Window Regulator / Heated rear window / Horn
						
MR 74 Relay, main current	12	-	40	-	5	Low Beam / Window Regulator / Heated rear window / Horn / Rear window wiper / Windscreen wiper / Fan, heater/air conditioning
						

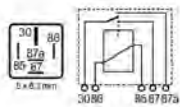
	Rated Voltage [V]	Rated Power [W]	Operating Current [A]	Rest current [A]	Number of Poles	Notes
<b>MR 75</b>  Relay, main current	12	-	40	15	5	Fan, heater/air conditioning / Rear window wiper / Windscreen wiper / Heated rear window / Horn / Low Beam / Window Regulator
						
<b>MR 76</b>  Relay, main current	24	-	22	10	5	Fan, heater/air conditioning / Rear window wiper / Windscreen wiper / Heated rear window / Horn / Low Beam / Window Regulator
						
<b>MR 77</b>  Relay, main current	24	-	22	-	5	Low Beam / Window Regulator / Heated rear window / Horn / Rear window wiper / Windscreen wiper / Fan, heater/air conditioning
						
<b>MR 78</b>  Relay, main current	12	-	40	-	4	Heated rear window / Horn / Rear window wiper / Windscreen wiper / Fan, heater/air conditioning / Low Beam / Window Regulator
						
<b>MR 79</b>  Relay, main current	12	-	40	-	5	Low Beam / Window Regulator / Heated rear window / Horn / Rear window wiper / Windscreen wiper / Fan, heater/air conditioning
						
<b>MR 80</b>  Relay, main current	12	-	40	15	5	Fan, heater/air conditioning / Rear window wiper / Windscreen wiper / Heated rear window / Horn / Low Beam / Window Regulator
						

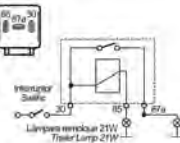

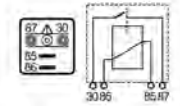

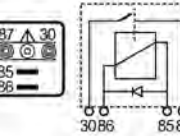





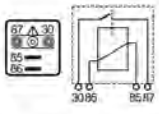

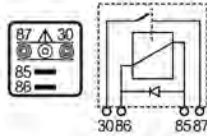

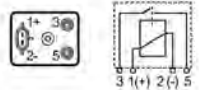
	Rated Voltage [V]	Rated Power [W]	Operating Current [A]	Rest current [A]	Number of Poles	Notes
<b>MR 81</b>  Relay, main current	12	-	40	-	4	-
						
<b>MR 82</b>  Multifunctional relay	12	-	40	15	5	-
						
<b>MR 83</b>  Multifunctional relay	12	-	40	15	5	with diode
						
<b>MR 84</b>  Relay, main current	12	-	40	-	4	Low Beam / Window Regulator / Heated rear window / Horn / Rear window wiper / Windscreen wiper / Fan, heater/air conditioning
						
<b>MR 85</b>  Relay, main current	12	-	40	-	4	Window Regulator / Horn / Low Beam / Windscreen wiper / Heated rear window / Fan, heater/air conditioning / Rear window wiper / with diode
						
<b>MR 86</b>  Relay, main current	12	-	40	-	4	Horn / Low Beam / Windscreen wiper / Heated rear window / Fan, heater/air conditioning / Rear window wiper / Window Regulator / with resistance
						

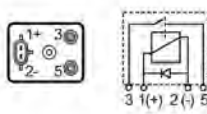

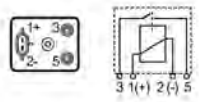

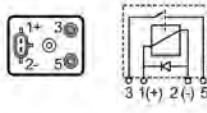

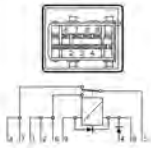

	Rated Voltage [V]	Rated Power [W]	Operating Current [A]	Rest current [A]	Number of Poles	Notes
<b>MR 87</b>  Relay, main current	24	-	22	-	4	Low Beam / Window Regulator / Heated rear window / Horn / Rear window wiper / Windscreen wiper / Fan, heater/air conditioning
						
<b>MR 88</b>  Relay, main current	24	-	22	-	4	Windscreen wiper / Heated rear window / Fan, heater/air conditioning / Rear window wiper / Window Regulator / Horn / Low Beam / with resistance
						
<b>MR 89</b>  Relay, main current	12	-	40	-	5	Low Beam / Window Regulator / Heated rear window / Horn / Rear window wiper / Windscreen wiper / Fan, heater/air conditioning
						
<b>MR 90</b>  Relay, main current	12	-	40	-	5	Fan, heater/air conditioning / Rear window wiper / Window Regulator / Horn / Low Beam / Windscreen wiper / Heated rear window / with diode
						
<b>MR 91</b>  Relay, main current	12	-	40	-	5	Window Regulator / Horn / Low Beam / Windscreen wiper / Heated rear window / Fan, heater/air conditioning / Rear window wiper / with resistance
						

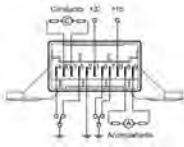

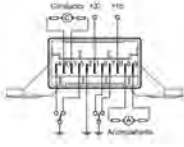

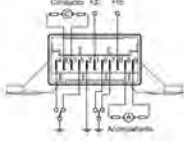







	Rated Voltage [V]	Rated Power [W]	Operating Current [A]	Rest current [A]	Number of Poles	Notes
MR 92 Relay, main current	12	-	40	15	5	Fan, heater/air conditioning / Rear window wiper / Windscreen wiper / Heated rear window / Horn / Low Beam / Window Regulator
						
MR 93 Relay, main current	12	-	40	15	5	Fan, heater/air conditioning / Rear window wiper / Windscreen wiper / Heated rear window / Horn / Low Beam / Window Regulator / with diode
						
MR 94 Relay, main current	12	-	40	15	5	Fan, heater/air conditioning / Rear window wiper / Windscreen wiper / Heated rear window / Horn / Low Beam / Window Regulator / with resistance
						
MR 95 Relay, main current	24	-	22	10	5	Fan, heater/air conditioning / Rear window wiper / Windscreen wiper / Heated rear window / Horn / Low Beam / Window Regulator
						
MR 96 Relay, main current	24	-	22	10	5	Fan, heater/air conditioning / Rear window wiper / Windscreen wiper / Heated rear window / Horn / Low Beam / Window Regulator / with diode
						

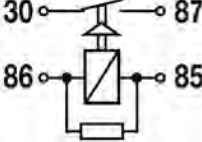











	Rated Voltage [V]	Rated Power [W]	Operating Current [A]	Rest current [A]	Number of Poles	Notes
MR 97 Relay, main current	24	-	22	10	5	Fan, heater/air conditioning / Rear window wiper / Windscreen wiper / Heated rear window / Horn / Low Beam / Window Regulator / with resistance
						
MR 98 Relay, main current	24	-	22	-	5	Fan, heater/air conditioning / Low Beam / Window Regulator / Heated rear window / Horn / Rear window wiper / Windscreen wiper
						
MR 99 Relay, main current	24	-	22	-	5	Window Regulator / Horn / Low Beam / Windscreen wiper / Heated rear window / Fan, heater/air conditioning / Rear window wiper / with diode
						
MR 100 Relay, main current	12	2X21W	-	-	3	-
						
MR 101 Relay, main current	24	-	100	-	4	-
						
MR 102 Relay, main current	24	-	100	-	4	with diode
						

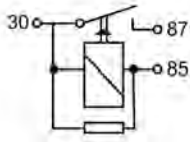



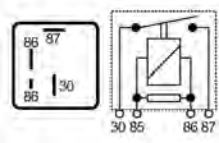

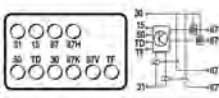



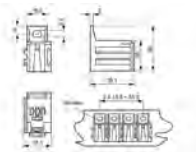

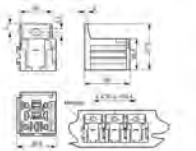





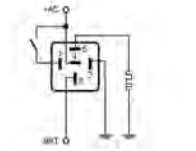

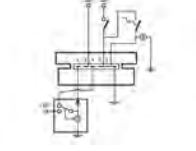

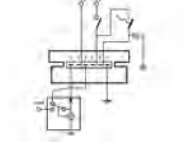



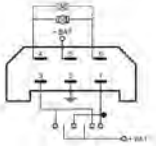

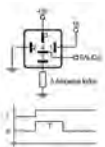

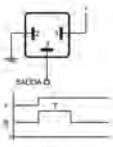
	Rated Voltage [V]	Rated Power [W]	Operating Current [A]	Rest current [A]	Number of Poles	Notes
MR 103	12	-	120	-	4	-
Relay, main current						
MR 104	12	-	120	-	4	with diode
Relay, main current						
MR 105	12	-	300	-	4	-
Relay, main current						
MR 106	12	-	300	-	4	with diode
Relay, main current						
MR 107	24	-	200	-	4	-
Relay, main current						
MR 108	24	-	200	-	4	with diode
Relay, main current						
MR 123	12	-	30	15	7	with diode
Multifunctional relay						

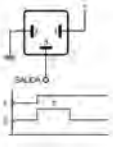

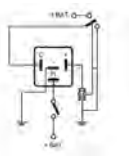

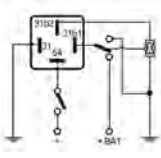

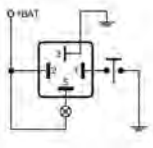



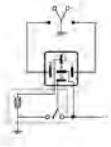

	Rated Voltage [V]	Current [A]	Number of poles
<b>MR 21</b>	12	10	11
<b>Relay, window lift</b>			
<b>MR 22</b>	24	10	11
<b>Relay, window lift</b>			
<b>MR 23</b>	24	10	11
<b>Relay, window lift</b>			
<b>MR 109</b>	12	15	6
<b>Relay, fuel pump</b>	OPEL 		

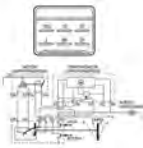

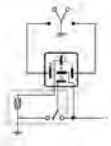



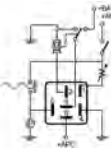



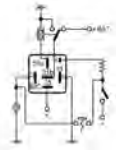

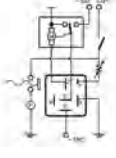
	Rated Voltage [V]	Current [A]	Number of poles
<b>MR 110</b>	12	30	5
<b>Relay, fuel pump</b>	AUDI, FORD, MAZDA, VW		
<b>MR 111</b>	12	16	7
<b>Relay, fuel pump</b>	OPEL		
<b>MR 112</b>	12	30	4
<b>Relay, fuel pump</b>	SEAT		
<b>MR 113</b>	12	16	7
<b>Relay, fuel pump</b>	ALFA-ROMEO, CITROEN, FIAT, LANCIA, PEUGEOT, SEAT		
<b>MR 114</b>	12	16	5
<b>Relay, fuel pump</b>	FORD		
<b>MR 115</b>	12	30	5
<b>Relay, fuel pump</b>	AUDI, VW		

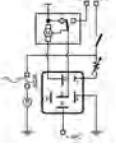
	Rated Voltage [V]	Current [A]	Number of poles
<b>MR 116</b> Relay, fuel pump BMW, OPEL, VOLVO	12	16	7
			
<b>MR 117</b> Relay, fuel pump CITROEN	12	16	7
			
<b>MR 118</b> Relay, fuel pump AUDI, SEAT	12	15	5
			
<b>MR 119</b> Relay, fuel pump AUDI, VW	12	16	5
			
<b>MR 120</b> Relay, fuel pump AUDI, FORD, LOTUS, NISSAN, SEAT, SKODA, VW	12	40	5
			
<b>MR 121</b> Relay, fuel pump MERCEDES-BENZ	12	10	10
			

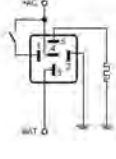

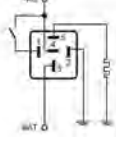
	Rated Voltage [V]	Current [A]	Number of poles
MRC 1	-	-	-
Relay socket			
MRC 2	-	-	-
Relay socket			
MRC 3	-	-	-
Relay socket			
MRC 4	-	-	-
Relay socket			
MT 1	12	-	5
Timer, fog light			
MT 2	12	-	-
Timer, wipe-/wash interval			
MT 3	12	-	-
Timer, wipe-/wash interval			

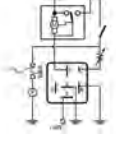

	Rated Voltage [V]	Current [A]	Number of poles
<b>MT 4</b>	12	-	6
Timer, wipe-/wash interval			
<b>MT 5</b>	12	-	5
Timer			
<b>MT 6</b>	12	-	3
Timer			
<b>MT 7</b>	24	-	3
Timer			
<b>MT 8</b>	12	-	4
Timer, wipe-/wash interval			
<b>MT 9</b>	12	-	4
Timer, wipe-/wash interval			
<b>MT 10</b>	12	-	4
Timer			

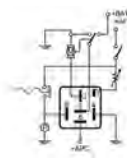

	Rated Voltage [V]	Current [A]	Number of poles
<b>MT 11</b>	12	-	5
Timer, wipe/ wash interval			
<b>MT 12</b>	12	-	6
Timer, wipe/ wash interval			
<b>MT 14</b>	24	-	6
Timer, wipe/ wash interval			
<b>MT 15</b>	24	-	5
Timer, wipe/ wash interval			
<b>MT 16</b>	12	-	6
Timer, wipe/ wash interval			
<b>MT 17</b>	24	-	6
Timer, wipe/ wash interval			

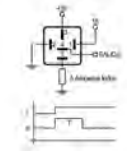

	Rated Voltage [V]	Current [A]	Number of poles
<b>MT 18</b>	12	-	6
<b>Timer, wipe-/wash interval</b>	ALFA-ROMEO, AUDI, CITROEN, FORD, OPEL, PEUGEOT, PORSCHE, RENAULT, SAAB, SEAT, VW		
			
<b>MT 19</b>	12	-	6
<b>Timer, wipe-/wash interval</b>			
<b>MT 20</b>	12	-	-
<b>Timer, wipe-/wash interval</b>			
<b>MT 21</b>	12	-	5
<b>Timer, rear windscreen heating</b>			
<b>MT 22</b>	24	-	5
<b>Timer, rear windscreen heating</b>			
<b>MT 23</b>	12	-	-
<b>Timer, wipe-/wash interval</b>			



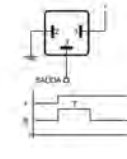



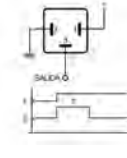



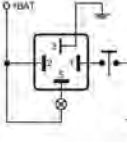

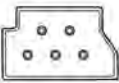

	Rated Voltage [V]	Current [A]	Number of poles
<b>MT 24</b>	24	-	6
<b>Timer, wipe/ wash interval</b>			

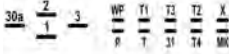



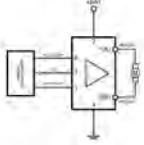

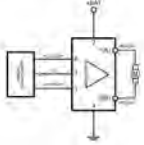
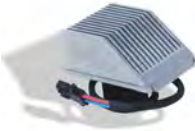



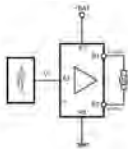

	Rated Voltage [V]	Current [A]	Preheating Time	Number of poles
<b>MT 5</b>	12	-	1	5
<b>Timer</b>				

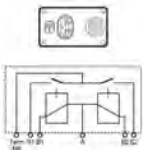



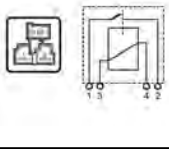

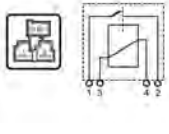

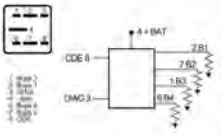

<b>MT 6</b>	12	-	7	3
<b>Timer</b>				

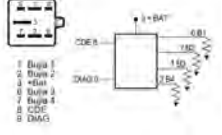



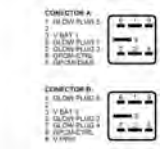



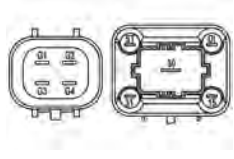

<b>MT 7</b>	24	-	7	3
<b>Timer</b>				

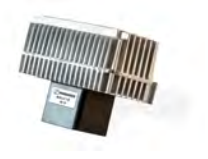
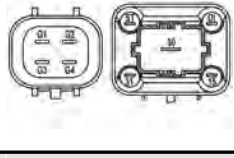

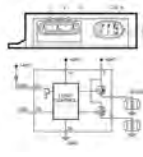

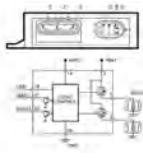

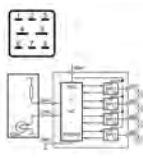



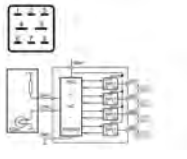

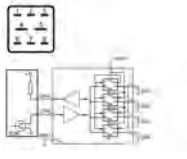
<b>MT 10</b>	12	-	-	4
<b>Timer</b>				

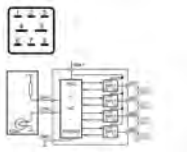

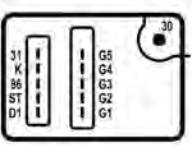



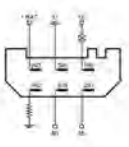



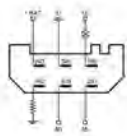

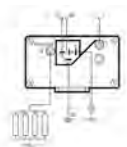
	Rated Voltage [V]	Current [A]	Number of poles
<b>MELM 1</b>	12	-	-
<b>Motor controllers, air conditioning</b>	BMW, PAYKAN, TATA		
<b>MELM 2</b>	12	-	-
<b>Motor controllers, air conditioning</b>	AUDI, SEAT, SKODA, VW		
<b>MELM 3</b>	12	-	-
<b>Motor controllers, air conditioning</b>	MINI, OPEL, SEAT, VW		
<b>MELM 4</b>	12	-	-
<b>Motor controllers, air conditioning</b>	AUDI, SKODA, VW		
<b>MELM 5</b>	12	-	-
<b>Motor controllers, air conditioning</b>	AUDI, MITSUBISHI, SEAT, SKODA		
<b>MELM 6</b>	12	-	-
<b>Motor controllers, air conditioning</b>			

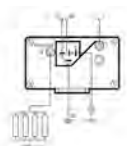

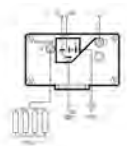

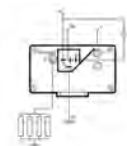

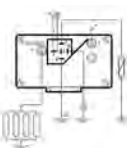



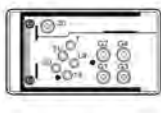

	Rated Voltage [V]	Current [A]	Number of poles
MELM 7	12	-	-
Motor controllers, air conditioning			
MELM 8	12	-	-
Motor controllers, air conditioning			
MHG 15	12	-	-
Heater control unit, glow plug system	CITROEN, PEUGEOT 		
MHG 16	12	-	-
Heater control unit, glow plug system	CITROEN, FIAT, LANCIA, PEUGEOT, RENAULT 		
MHG 17	12	-	4
Heater control unit, glow plug system			
MHG 18	24	-	4
Heater control unit, glow plug system			

	Rated Voltage [V]	Current [A]	Preheating Time	Number of poles
ME 7	12	-	-	-
Heater control unit, glow plug system	NISSAN, OPEL, RENAULT			
MHG 1	12	-	-	-
Heater control unit, glow plug system	CITROEN, OPEL, RENAULT, VAUXHALL			
MHG 2	12	-	-	-
Heater control unit, glow plug system	NISSAN, OPEL, RENAULT, TOYOTA			
MHG 3	12	-	-	-
Heater control unit, glow plug system				
MHG 4	12	-	-	-
Heater control unit, glow plug system				
MHG 5	12	-	-	-
Heater control unit, glow plug system	OPEL, PROTON, SUZUKI, VW			

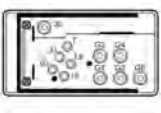









	Rated Voltage [V]	Current [A]	Preheating Time	Number of poles
MHG 6	12	-	-	-
Heater control unit, glow plug system	OPEL			
MHG 7	12	-	-	-
Heater control unit, glow plug system	OPEL			
MHG 8	12	-	-	-
Heater control unit, glow plug system	OPEL			
MHG 9	12	-	-	-
Heater control unit, glow plug system	RENAULT			
MHG 10	12	-	-	-
Heater control unit, glow plug system	OPEL, RENAULT, VAUXHALL			
MHG 11	12	-	-	-
Heater control unit, glow plug system	AUDI, CITROEN, FORD, LAND ROVER, PEUGEOT			







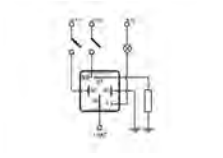

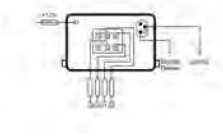

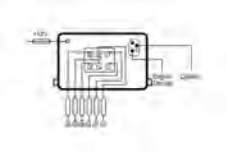

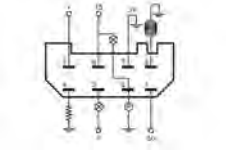
	Rated Voltage [V]	Current [A]	Preheating Time	Number of poles
MHG 12	12	-	-	-
Heater control unit, glow plug system	FORD			
MHG 13	12	-	-	-
Heater control unit, glow plug system	DACIA, MITSUBISHI, NISSAN, OPEL, RENAULT			
MHG 14	12	-	-	-
Heater control unit, glow plug system	DACIA, NISSAN, OPEL, RENAULT			
MHG 21	12	-	-	-
Heater control unit, glow plug system	ALFA-ROMEO, CITROEN, FIAT			
MHG 22	12	-	-	9
Heater control unit, glow plug system	AUDI, SEAT, SKODA, VW, WIESMANN			
MHG 23	12	-	-	-
Heater control unit, glow plug system				

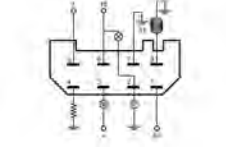

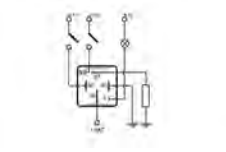

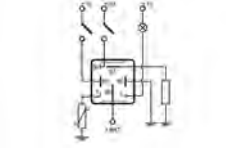

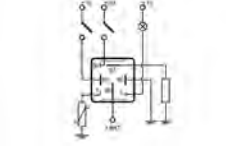



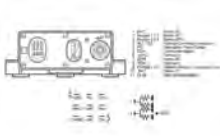

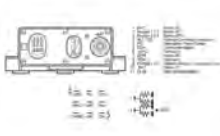
	Rated Voltage [V]	Current [A]	Preheating Time	Number of poles
MHG 24	24	-	-	-
Heater control unit, glow plug system				
MHG 25	12	-	15	-
Heater control unit, glow plug system	CITROEN, OPEL, PEUGEOT, TALBOT 			
MHG 26	12	-	7	-
Heater control unit, glow plug system	CITROEN, FIAT, LANCIA, NISSAN, PEUGEOT, RENAULT, SEAT, TALBOT 			
MHG 27	24	-	7	-
Heater control unit, glow plug system				
MHG 28	12	-	7	-
Heater control unit, glow plug system	ALFA-ROMEO, RENAULT 			
MHG 29	12	-	7	-
Heater control unit, glow plug system	ALFA-ROMEO, CHRYSLER 			

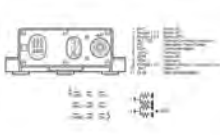

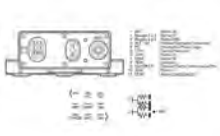

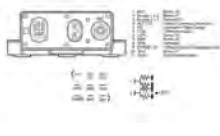

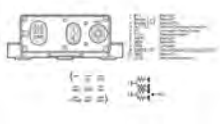



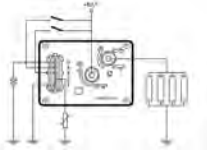

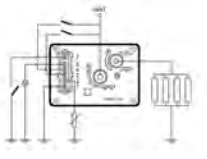
	Rated Voltage [V]	Current [A]	Preheating Time	Number of poles
MHG 30	12	-	-	-
Heater control unit, glow plug system	MERCEDES-BENZ			
MHG 31	12	-	-	-
Heater control unit, glow plug system	MERCEDES-BENZ			
MHG 32	12	-	-	-
Heater control unit, glow plug system	MERCEDES-BENZ			
MHG 33	12	-	-	-
Heater control unit, glow plug system	MERCEDES-BENZ			
MHG 34	12	-	-	9
Heater control unit, glow plug system	AUDI, SEAT, SKODA, VW	 <ul style="list-style-type: none"> <li>01 - GLOW PLUG</li> <li>02 - GLOW PLUG</li> <li>03 - GLOW PLUG</li> <li>04 - GLOW PLUG</li> <li>05 - +</li> <li>07 - K15000/17</li> <li>31 - GROUND</li> <li>05 - +</li> <li>51 - MAGNETIC</li> <li>31 - +</li> <li>51 - CONTROL</li> </ul>		
MHG 35	12	-	-	9
Heater control unit, glow plug system	AUDI, FORD, FORD USA, MERCEDES-BENZ, OPEL, RENAULT, SEAT, SKODA, VW	 <ul style="list-style-type: none"> <li>01 - GLOW PLUG</li> <li>02 - GLOW PLUG</li> <li>03 - GLOW PLUG</li> <li>04 - GLOW PLUG</li> <li>05 - +</li> <li>07 - K15000/17</li> <li>31 - GROUND</li> <li>05 - +</li> <li>51 - MAGNETIC</li> <li>31 - +</li> <li>51 - CONTROL</li> </ul>		

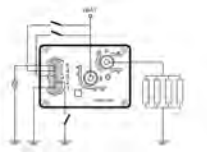

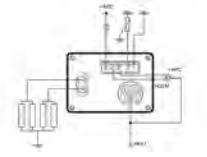

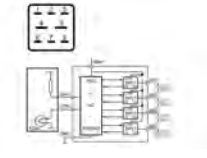





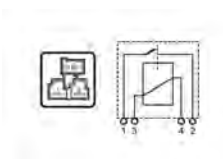

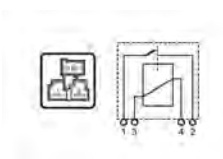



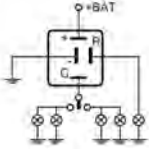

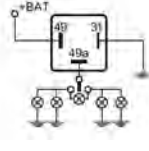

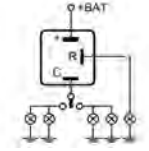
	Rated Voltage [V]	Current [A]	Preheating Time	Number of poles
MHG 36	12	-	-	9
Heater control unit, glow plug system	AUDI, SEAT, SKODA, VW			
				
MHG 37	12	-	-	9
Heater control unit, glow plug system	AUDI, RENAULT, SEAT, SKODA, VW			
				
MHG 38	12	-	-	9
Heater control unit, glow plug system	AUDI, MERCEDES-BENZ, OPEL, SEAT, VW			
				
MHG 39	12	-	-	11
Heater control unit, glow plug system	AUDI, PORSCHE, VW			
				
MHG 40	12	-	5	6
Heater control unit, glow plug system	FORD, OPEL			
				
MHG 41	12	-	-	-
Heater control unit, glow plug system	FORD, MERCEDES-BENZ, PEUGEOT			
				

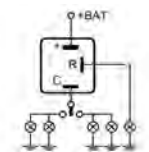

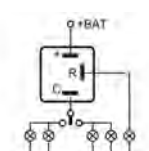

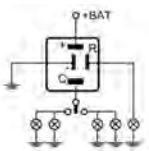

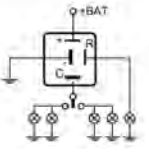



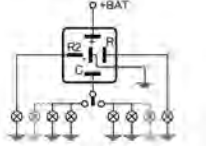

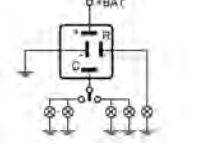

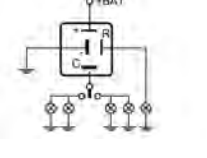
	Rated Voltage [V]	Current [A]	Preheating Time	Number of poles
MHG 42	12	-	-	-
Heater control unit, glow plug system	MERCEDES-BENZ			
MHG 43	12	-	-	-
Heater control unit, glow plug system				
MHG 44	24	-	-	-
Heater control unit, glow plug system				
MHG 45	12	-	2	6
Heater control unit, glow plug system	FORD, VAUXHALL			
MHG 46	12	-	5	6
Heater control unit, glow plug system	AUDI, VW			
MHG 47	24	-	-	6
Heater control unit, glow plug system				

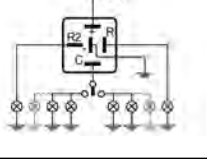

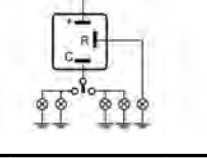

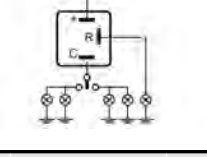

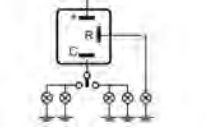



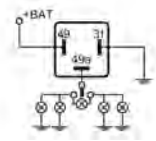

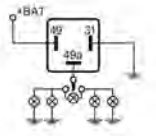

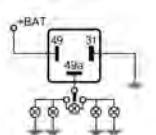
	Rated Voltage [V]	Current [A]	Preheating Time	Number of poles
MHG 48	12	-	2	-
Heater control unit, glow plug system	RENAULT			
MHG 49	12	-	4	-
Heater control unit, glow plug system				
MHG 50	12	-	4	-
Heater control unit, glow plug system	RENAULT			
MHG 51	12	-	7	-
Heater control unit, glow plug system	RENAULT			
MHG 52	12	-	7	-
Heater control unit, glow plug system				
MHG 53	12	-	7	-
Heater control unit, glow plug system	RENAULT			

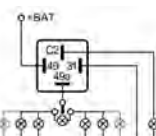
	Rated Voltage [V]	Current [A]	Preheating Time	Number of poles
<b>MHG 54</b>	12	-	5	-
Heater control unit, glow plug system	CITROEN, FIAT, PEUGEOT			
				
<b>MHG 55</b>	12	-	3	-
Heater control unit, glow plug system	ALFA-ROMEO, CITROEN, FIAT, PEUGEOT			
				
<b>MHG 56</b>	12	-	5	-
Heater control unit, glow plug system	CITROEN, FIAT, PEUGEOT			
				
<b>MHG 57</b>	12	-	4	-
Heater control unit, glow plug system	RENAULT			
				
<b>MHG 58</b>	12	-	-	-
Heater control unit, glow plug system				
				
<b>MR 122</b>	12	25	-	7
Heater control unit, glow plug system				
				

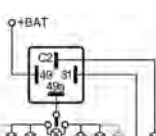

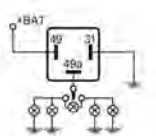

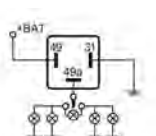





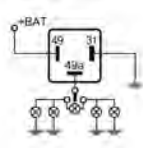

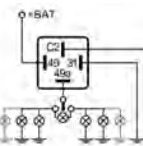
	Rated Voltage [V]	Current [A]	Number of poles
<b>MHG 19</b>	12	-	4
<b>Heater control unit, glow plug system</b> NISSAN			
<b>MHG 20</b>	12	-	4
<b>Heater control unit, glow plug system</b> NISSAN			

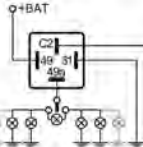

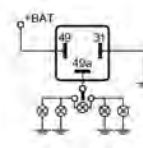

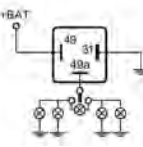

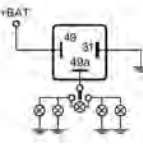



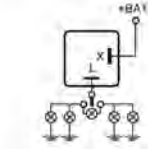

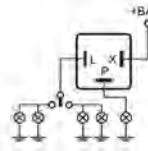

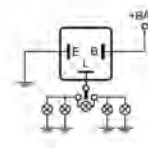
	Voltage [V]	Rated Voltage [V]	Power [W]	Switching Capacity [W]	Number of Poles	Notes
MFL 1	-	12	-	LED	4	IndicatorFitting
Flasher						
MFL 2	-	12	-	LED	3	IndicatorFitting
Flasher						
MFL 3	-	12	-	180W	3	Indicator
Flasher						
MFL 4	-	12	-	180W	3	Indicator
Flasher						
MFL 5	-	24	-	84W	3	IndicatorFitting
Flasher						
MFL 6	-	12	-	2(4)X21W+0.4W	4	Indicator
Flasher						
MFL 7	-	24	-	2(4)X21W+0.4W	4	IndicatorFitting
Flasher						

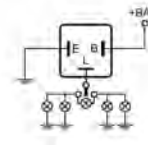

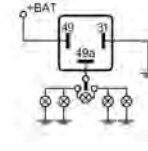

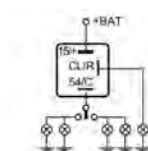

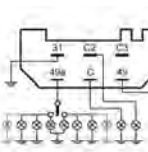



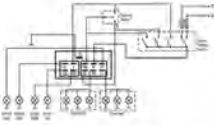

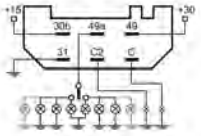
	Voltage [V]	Rated Voltage [V]	Power [W]	Switching Capacity [W]	Number of Poles	Notes
MFL 8	-	12	-	2+1(6)X21W+(2)0..4W	5	Indicator
Flasher						
MFL 9	-	12	-	2(4)X21W+0..4W	4	Indicator
Flasher						
MFL 10	-	24	-	2(4)X21W+0..4W	4	IndicatorFitting
Flasher						
MFL 11	-	12	-	2+1(6)X21W+(2)0..4W	5	Indicator
Flasher						
MFL 12	-	24	-	2(4)X21W+0..4W	3	IndicatorFitting
Flasher						
MFL 13	-	12	-	2(4)X21W+0..4W	3	Indicator
Flasher						
MFL 14	-	12	-	2(4)X21W+0..4W	3	Indicator
Flasher						

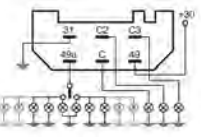

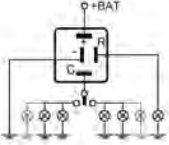

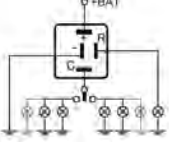
	Voltage [V]	Rated Voltage [V]	Power [W]	Switching Capacity [W]	Number of Poles	Notes
MFL 15	-	12	-	110W	3	Indicator
Flasher						
MFL 16	-	12	-	2(4)X21W+0.4W	3	Indicator
Flasher						
MFL 17	-	24	-	2(4)X21W+0.4W	3	IndicatorFitting
Flasher						
MFL 18	-	12	-	2+1(6)X21W+(2)0.4W	4	Indicator
Flasher						
MFL 19	-	24	-	2+1(6)X21W+(2)0.4W	4	IndicatorFitting
Flasher						
MFL 20	-	12	-	2(4)X21W+0.4W	3	Indicator
Flasher						
MFL 21	-	12	-	2(4)X21W+0.4W	3	Indicator
Flasher						

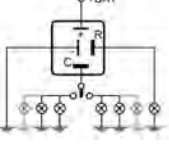



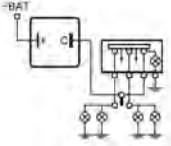

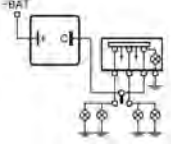



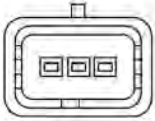

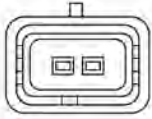

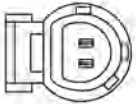
	Voltage [V]	Rated Voltage [V]	Power [W]	Switching Capacity [W]	Number of Poles	Notes
MFL 22	-	24	-	2(4)X21W+0..4W	3	IndicatorElectronicFitting
Flasher	BMW, MAHINDRA, OLTCIT					
						
MFL 23	-	12	-	2+1(6)X21W+(2)0..4W	4	IndicatorElectronicFitting
Flasher	ALFA-ROMEO, BMW, FORD, MAHINDRA, MERCEDES-BENZ, MINELLI, OLTCIT, PEUGEOT, RENAULT, SUBARU, SUZUKI, TOYOTA					
						
MFL 24	-	24	-	2+1(6)X21W+(2)0..4W	4	IndicatorFitting
Flasher						
						
MFL 25	-	12	-	2(4)X23W+0..4W	3	Indicator
Flasher						
						
MFL 26	-	12	-	De 3 a 92W.	3	IndicatorFitting
Flasher						
						
MFL 27	-	12	-	De 3 a 92W.	3	IndicatorFitting
Flasher						
						

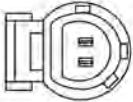









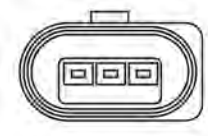

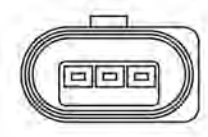
	Voltage [V]	Rated Voltage [V]	Power [W]	Switching Capacity [W]	Number of Poles	Notes
MFL 28	-	12	-	180W	2	Indicator
Flasher						
MFL 29	-	12	-	180W	3	Indicator
Flasher						
MFL 30	-	12	-	2(4)X21W+0..4W	3	Indicator
Flasher						
MFL 31	-	12	-	2(4)X21W+0..4W	3	Indicator
Flasher						
MFL 32	-	12	-	100W	3	Indicator
Flasher						
MFL 33	-	24	-	500W	3	IndicatorFitting
Flasher						
MFL 34	-	12	-	(2+1)X21W+5W	6	IndicatorFitting
Flasher						

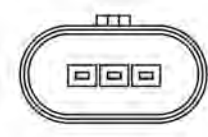
	Voltage [V]	Rated Voltage [V]	Power [W]	Switching Capacity [W]	Number of Poles	Notes
<b>MFL 35</b>	-	24	-	170W	11	IndicatorElectronicFitting
<b>Flasher</b>	ALFA-ROMEO, ASTON MARTIN, BMW, CHEVROLET, CITROEN, FIAT, FORD, HONDA, MERCEDES-BENZ, MITSUBISHI, NISSAN, PEUGEOT, RENAULT, SAAB, STANGUELLI, VW					
						
<b>MFL 36</b>	-	24	-	(2+1)X21W+5W	6	IndicatorElectronicFitting
<b>Flasher</b>	ALPINA, AUDI, CHEVROLET, CITROEN, FIAT, FORD, HONDA, MAZDA, MERCEDES-BENZ, MITSUBISHI, NISSAN, OPEL, RENAULT, SUZUKI, TOYOTA, VAUXHALL, VOLVO, VW					
						
<b>MFL 37</b>	-	12	-	(2+1+1)X21W.+5W+(3)0	6	IndicatorFitting
<b>Flasher</b>						
<b>MFL 38</b>	-	12	-	2+1(6)X21W+(1)0..4W	4	Indicator
<b>Flasher</b>						
<b>MFL 39</b>	-	12	-	2+1(6)X21W+(1)0..4W	4	Indicator
<b>Flasher</b>						
<b>MFL 40</b>	-	24	-	2+1(6)X21W+(1)0..4W	4	IndicatorFitting
<b>Flasher</b>						

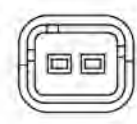
	Voltage [V]	Rated Voltage [V]	Power [W]	Switching Capacity [W]	Number of Poles	Notes
<b>MFL 41</b>	-	12	-	180W	2	IndicatorFitting
<b>Flasher</b>						
<b>MFL 42</b>	-	24	-	500W	2	IndicatorFitting
<b>Flasher</b>						

	Rated Voltage [V]		
<b>MSC 1</b>	12		
<b>Crankshaft sensor</b>	CITROEN, FERRARI, FORD, MAZDA, OPEL, PEUGEOT, VOLVO		
<b>MSC 2</b>	12		
<b>Crankshaft sensor</b>	CITROEN, FIAT, LANCIA, PEUGEOT		
<b>MSC 3</b>	12		
<b>Crankshaft sensor</b>	DACIA, NISSAN, RENAULT		
<b>MSC 4</b>	12		
<b>Crankshaft sensor</b>	DACIA, NISSAN, OPEL, RENAULT		
<b>MSC 5</b>	12		
<b>Crankshaft sensor</b>	AUDI, FORD, HONDA, SEAT, SKODA, VW		
<b>MSC 6</b>	12		
<b>Crankshaft sensor</b>	CITROEN, FIAT, FORD, JAGUAR, LAND ROVER, PEUGEOT		

Rated Voltage [V]

<p><b>MSC 7</b></p>	<p>12</p>
<p><b>Crankshaft sensor</b></p>	<p>AUDI, FORD, HONDA, SEAT, SKODA, VW</p> <div style="display: flex; justify-content: space-around; align-items: center;">   </div>
<p><b>MSC 8</b></p>	<p>12</p>
<p><b>Crankshaft sensor</b></p>	<p>AUDI, MITSUBISHI, SEAT, SKODA, VW</p> <div style="display: flex; justify-content: space-around; align-items: center;">   </div>
<p><b>MSO 1</b></p>	<p>12</p>
<p><b>Pulse sensor, flywheel</b></p>	<p>CITROEN, FORD, PEUGEOT</p> <div style="display: flex; justify-content: space-around; align-items: center;">   </div>
<p><b>MST 1</b></p>	<p>12</p>
<p><b>Temperature sensor</b></p>	<p>AUDI, CITROEN, FIAT, LANCIA, PEUGEOT, RENAULT, SSANGYONG, TOYOTA, VW</p> <div style="display: flex; justify-content: space-around; align-items: center;">   </div>
<p><b>MST 2</b></p>	<p>12</p>
<p><b>Temperature sensor</b></p>	<div style="display: flex; justify-content: space-around; align-items: center;">   </div>
<p><b>MST 3</b></p>	<p>12</p>
<p><b>Temperature sensor</b></p>	<div style="display: flex; justify-content: space-around; align-items: center;">   </div>









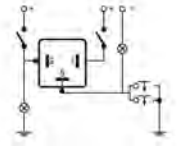

Rated Voltage [V]

MSW 5



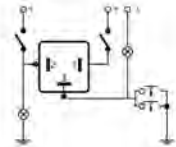

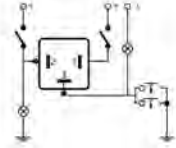
12 / 24



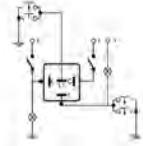

Water sensor,  
fuel system

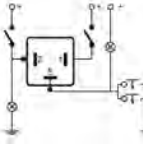

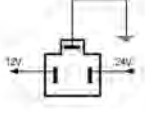

	Rated Voltage [V]	Power [W]	Frequency [Hz]	Sound Level [db]	Number of poles
<b>MEWD 1</b>	12	-	-	+80	3
Lights-on reminder					
<b>MEWD 2</b>	12	-	-	-	-
Lights-on reminder					
<b>MEWD 3</b>	-	-	-	-	-
Lights-on reminder					
<b>MEWD 4</b>	12	-	-	+65	2
Hazard lights relay					
<b>MEWD 5</b>	24	-	-	+65	2
Hazard lights relay					
<b>MEWD 6</b>	12	-	-	+65	3
Lights-on reminder					
<b>MEWD 7</b>	24	-	-	+65	3
Lights-on reminder					



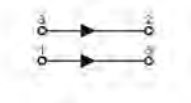

	Rated Voltage [V]	Power [W]	Frequency [Hz]	Sound Level [db]	Number of poles
<b>MEWD 8</b>	12	-	-	+65	3
Lights-on reminder					
<b>MEWD 9</b>	12	-	-	+85	3
Lights-on reminder					

	Rated Voltage [V]	Current [A]
<b>MPD 1</b>	-	3
<b>Voltage transformer</b>		
<b>MPD 2</b>	-	20
<b>Voltage transformer</b>		

	Rated Voltage [V]	Current [A]	Diode Type
ME 2	12	3	Diode Block
Diode			

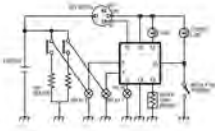
	Rated Voltage [V]	Current [A]
ME 1	12	9
Alternator regulator		

	Rated Voltage [V]	
ME 3	12	
Control unit, heating / ventilation		

# Comparison chart of vehicle manufacturers

## BMW

64 11 6923 204.....	<b>MELM 1</b>
64 11 6929 486.....	<b>MELM 1</b>
64 11 6929 540.....	<b>MELM 1</b>
64 11 6931 680.....	<b>MELM 1</b>
64 11 8362 931.....	<b>MELM 1</b>
64 11 8364 173.....	<b>MELM 1</b>
64 11 8376 174.....	<b>MELM 1</b>
64 11 8377 579.....	<b>MELM 1</b>
64 11 8380 580.....	<b>MELM 1</b>
64 11 8383 835.....	<b>MELM 1</b>
64 11 8385 549.....	<b>MELM 1</b>
6923204.....	<b>MELM 1</b>
6929540.....	<b>MELM 1</b>
8362931.....	<b>MELM 1</b>
8376174.....	<b>MELM 1</b>
8380580.....	<b>MELM 1</b>

## CHRYSLER

05170859AA.....	<b>MHG 42</b>
05170859AA.....	<b>MHG 57</b>
4686062.....	<b>MHG 29</b>
5170859AA.....	<b>MHG 42</b>
5170859AA.....	<b>MHG 57</b>

## CITROEN

1338-88.....	<b>MST 1</b>
1338-A7.....	<b>MST 1</b>
1920.LV.....	<b>MSC 6</b>
1920-AW.....	<b>MSC 2</b>
1920-EH.....	<b>MSC 1</b>
5981.16.....	<b>MHG 26</b>
5981.16.....	<b>MHG 41</b>
5981.13.....	<b>MHG 25</b>
5981.13.....	<b>MHG 40</b>
5981.19.....	<b>MHG 16</b>
5981.19.....	<b>MHG 30</b>
5981.19.....	<b>MHG 56</b>
5981.24.....	<b>MHG 54</b>
5981.26.....	<b>MHG 55</b>
5981.27.....	<b>MHG 55</b>
5981.42.....	<b>MHG 21</b>
5981.42.....	<b>MHG 36</b>
5981.44.....	<b>MHG 11</b>
5981.44.....	<b>MHG 12</b>
598115.....	<b>MHG 26</b>
598115.....	<b>MHG 41</b>
598116.....	<b>MHG 16</b>
598116.....	<b>MHG 30</b>
598120.....	<b>MHG 56</b>

## CITROEN

598121.....	<b>MHG 54</b>
598121.....	<b>MHG 55</b>
598131.....	<b>MHG 16</b>
598131.....	<b>MHG 30</b>
598138.....	<b>MHG 16</b>
598138.....	<b>MHG 30</b>
598140.....	<b>MHG 1</b>
598140.....	<b>MHG 2</b>
91000409.....	<b>MR 117</b>
91515869.....	<b>MHG 26</b>
91515869.....	<b>MHG 41</b>
9151586980.....	<b>MHG 26</b>
9151586980.....	<b>MHG 41</b>
91541882.....	<b>MR 117</b>
92515867.....	<b>MHG 26</b>
92515867.....	<b>MHG 41</b>
92 515 867 80.....	<b>MHG 26</b>
92 515 867 80.....	<b>MHG 41</b>
92 515 869 80.....	<b>MHG 26</b>
92 515 869 80.....	<b>MHG 41</b>
95 492 995 80.....	<b>MHG 25</b>
95 492 995 80.....	<b>MHG 40</b>
95 534 787 80.....	<b>MHG 25</b>
95 534 787 80.....	<b>MHG 40</b>
96.622.215.80.....	<b>MSC 6</b>
9614167780.....	<b>MHG 56</b>
9616280080.....	<b>MHG 55</b>
96165823.....	<b>MHG 55</b>
96 165 823 80.....	<b>MHG 55</b>
96 165 824.....	<b>MHG 54</b>
96 165 824 80.....	<b>MHG 54</b>
9625203680.....	<b>MHG 56</b>
9627326180.....	<b>MR 109</b>
9636777180.....	<b>MST 1</b>
9637220880.....	<b>MSC 1</b>
9637465980.....	<b>MSC 2</b>
96 374 669 80.....	<b>MSC 1</b>
9639912580.....	<b>MHG 16</b>
9639912580.....	<b>MHG 30</b>
96 399 998 80.....	<b>MSC 2</b>
9640469680.....	<b>MHG 1</b>
9640469680.....	<b>MHG 2</b>
96 638 248 80.....	<b>MHG 11</b>
96 638 248 80.....	<b>MHG 12</b>
9675323280.....	<b>MSO 1</b>

## DAF

038 4127.....	<b>MFL 36</b>
---------------	---------------

## FIAT

05990986.....	<b>MHG 54</b>
116619601600.....	<b>MHG 28</b>
124717.....	<b>MR 117</b>
1348881080.....	<b>MHG 16</b>
1348881080.....	<b>MHG 30</b>
162064501000.....	<b>MHG 29</b>
164761113500.....	<b>MR 117</b>
195051104300.....	<b>MHG 20</b>
195051104300.....	<b>MR 113</b>
311609.....	<b>MHG 25</b>
43423043.....	<b>MHG 54</b>
4613 8456.....	<b>MHG 54</b>
46414088.....	<b>MHG 54</b>
46423043.....	<b>MHG 55</b>
4642 8175.....	<b>MHG 25</b>
4642 8175.....	<b>MHG 40</b>
46438456.....	<b>MHG 54</b>
46742375.....	<b>MHG 21</b>
46742375.....	<b>MHG 36</b>
46798692.....	<b>MHG 21</b>
46798692.....	<b>MHG 36</b>
46807091.....	<b>MHG 21</b>
46807091.....	<b>MHG 36</b>
46812667.....	<b>MHG 21</b>
46812667.....	<b>MHG 36</b>
46812668.....	<b>MHG 21</b>
46812668.....	<b>MHG 36</b>
4792112.....	<b>MHG 26</b>
4792112.....	<b>MHG 41</b>
51771823.....	<b>MHG 21</b>
51771823.....	<b>MHG 36</b>
51888255.....	<b>MHG 21</b>
51888255.....	<b>MHG 36</b>
55187288.....	<b>MHG 21</b>
55187288.....	<b>MHG 36</b>
55193073.....	<b>MHG 21</b>
55193073.....	<b>MHG 36</b>
5888780.....	<b>MFL 23</b>
5946920.....	<b>MHG 26</b>
5946920.....	<b>MHG 41</b>
5946920.....	<b>MHG 55</b>
5946923.....	<b>MR 117</b>
59469230.....	<b>MR 117</b>
5990986.....	<b>MHG 26</b>
5990986.....	<b>MHG 41</b>
5990986.....	<b>MHG 54</b>
605078062.....	<b>MHG 29</b>
60507807.....	<b>MHG 29</b>

# Comparison chart of vehicle manufacturers

## FIAT

605078070 .....	<b>MHG 29</b>
605139290 .....	<b>MHG 29</b>
60534316 .....	<b>MHG 20</b>
60534316 .....	<b>MR 113</b>
605343160 .....	<b>MHG 20</b>
605343160 .....	<b>MR 113</b>
60800132 .....	<b>MR 117</b>
60801844 .....	<b>MHG 21</b>
60801844 .....	<b>MHG 36</b>
60801874 .....	<b>MHG 21</b>
60801874 .....	<b>MHG 36</b>
60802047 .....	<b>MHG 21</b>
60802047 .....	<b>MHG 36</b>
60812527 .....	<b>MHG 54</b>
60816316 .....	<b>MHG 21</b>
60816316 .....	<b>MHG 36</b>
62370600 .....	<b>MR 113</b>
7576067 .....	<b>MHG 20</b>
7576067 .....	<b>MR 113</b>
7617640 .....	<b>MHG 26</b>
7617640 .....	<b>MHG 41</b>
7628059 .....	<b>MHG 20</b>
7628059 .....	<b>MR 113</b>
7717686 .....	<b>MR 116</b>
7735921 .....	<b>MHG 54</b>
7750753 .....	<b>MR 117</b>
7750754 .....	<b>MHG 20</b>
7750754 .....	<b>MR 113</b>
83BB6B092AA .....	<b>MHG 40</b>
83BB6B092AA .....	<b>MHG 55</b>
83BB6M092BA .....	<b>MHG 40</b>
83BB6M092BA .....	<b>MHG 55</b>
88BB6B092BA .....	<b>MHG 40</b>
88BB6B092BA .....	<b>MHG 55</b>
88BG8B658AA .....	<b>MHG 40</b>
88BG8B658AA .....	<b>MHG 55</b>
9614167780 .....	<b>MHG 56</b>
961 5938 380 .....	<b>MHG 55</b>
9615959448 .....	<b>MHG 54</b>
961 5959 48 .....	<b>MHG 54</b>
9616582480 .....	<b>MHG 54</b>
9619039780 .....	<b>MHG 16</b>
9619039780 .....	<b>MHG 30</b>
9637465980 .....	<b>MSC 2</b>
9639912580 .....	<b>MHG 16</b>
9639912580 .....	<b>MHG 30</b>
9662221580 .....	<b>MSC 6</b>

## FORD

1143426 .....	<b>MHG 30</b>
1143723 .....	<b>MSC 6</b>
1 252 609 .....	<b>MHG 2</b>
148073 .....	<b>MSC 1</b>
1630263 .....	<b>MHG 45</b>
1630363 .....	<b>MHG 45</b>
1652479 .....	<b>MHG 45</b>
1672529 .....	<b>MHG 12</b>
1693301 .....	<b>MHG 12</b>
1693301 .....	<b>MHG 13</b>
1717564 .....	<b>MSO 1</b>
1744454 .....	<b>MSO 1</b>
2S61-12A343-AA .....	<b>MHG 16</b>
2S61-12A343-AA .....	<b>MHG 30</b>
2S6Q9E731AA .....	<b>MSC 1</b>
2S7Q-6C315-AC .....	<b>MSC 6</b>
3M5T-12A343-AA .....	<b>MHG 2</b>
6107322 .....	<b>MHG 21</b>
6107322 .....	<b>MR 114</b>
6132248 .....	<b>MHG 45</b>
6143688 .....	<b>MHG 40</b>
6143688 .....	<b>MHG 55</b>
6171402 .....	<b>MHG 45</b>
6194291 .....	<b>MHG 45</b>
6756611 .....	<b>MHG 45</b>
6756612 .....	<b>MHG 45</b>
6847572 .....	<b>MHG 40</b>
6847572 .....	<b>MHG 55</b>
68477572 .....	<b>MHG 45</b>
82GG-9P704-AA .....	<b>MHG 21</b>
82GG-9P704-AA .....	<b>MR 114</b>
83BB6B092AA .....	<b>MHG 40</b>
83BB6B092AA .....	<b>MHG 55</b>
83BB6B092BA .....	<b>MHG 40</b>
83BB6B092BA .....	<b>MHG 55</b>
83BB6M092BA .....	<b>MHG 40</b>
83BB6M092BA .....	<b>MHG 55</b>
84FB006M092BA .....	<b>MHG 45</b>
84FB006M092CB .....	<b>MHG 45</b>
84FB6M092BA .....	<b>MHG 45</b>
84FB6M092CA .....	<b>MHG 45</b>
84FB6M092CB .....	<b>MHG 45</b>
88BG8B658AA .....	<b>MHG 55</b>
89FB6M092AA .....	<b>MHG 45</b>
89GB-6M092-AA .....	<b>MHG 45</b>
90BB6M092BA .....	<b>MHG 45</b>
90BB6M092BB .....	<b>MHG 45</b>
90BB6M092CA .....	<b>MHG 45</b>

## FORD

93BB6M092AA .....	<b>MHG 40</b>
93BB6M092AA .....	<b>MHG 55</b>
93BB6M092BA .....	<b>MHG 40</b>
93BB6M092BA .....	<b>MHG 55</b>
9M5Q-12A343-AA .....	<b>MHG 12</b>
9M5Q-12A343-AA .....	<b>MHG 13</b>
AV61-12A343-BA .....	<b>MHG 12</b>
BK21-6C315-AA .....	<b>MSO 1</b>
BK21-6C315-AB .....	<b>MSO 1</b>
V85AB9P704AA .....	<b>MR 117</b>
YC3Z12B533AA .....	<b>MHG 5</b>

## GENERAL MOTORS

090040992 .....	<b>MHG 40</b>
090228928 .....	<b>MHG 40</b>
090341822 .....	<b>MHG 40</b>
09108385 .....	<b>MHG 9</b>
09110178 .....	<b>MHG 15</b>
09110560 .....	<b>MSC 4</b>
1238539 .....	<b>MR 109</b>
1238540 .....	<b>MR 109</b>
1238542 .....	<b>MR 116</b>
1238549 .....	<b>MR 109</b>
1238563 .....	<b>MR 111</b>
1238566 .....	<b>MR 111</b>
55353011 .....	<b>MHG 5</b>
55354141 .....	<b>MHG 7</b>
55557761 .....	<b>MHG 8</b>
90124673 .....	<b>MR 111</b>
90158189 .....	<b>MR 111</b>
90213542 .....	<b>MR 116</b>
90225811 .....	<b>MR 109</b>
90228928 .....	<b>MHG 40</b>
90230894 .....	<b>MR 109</b>
90240651 .....	<b>MHG 40</b>
90240698 .....	<b>MR 109</b>
90276101 .....	<b>MHG 40</b>
90341822 .....	<b>MHG 40</b>
90378651 .....	<b>MR 109</b>
90464952 .....	<b>MHG 40</b>
9110510 .....	<b>MHG 53</b>
9110721 .....	<b>MHG 10</b>
91167210 .....	<b>MHG 2</b>
9132691 .....	<b>MHG 7</b>
9201699 .....	<b>MHG 2</b>
93203424 .....	<b>MT 18</b>
93858431 .....	<b>MHG 1</b>
93862497 .....	<b>MHG 14</b>

# Comparison chart of vehicle manufacturers

## GENERAL MOTORS

94629840..... **MT 18**  
 94646585..... **MT 18**

## IVECO

04642 8175..... **MHG 25**  
 04642 8175..... **MHG 40**  
 462703..... **MHG 26**  
 462703..... **MHG 41**  
 5010 168944..... **MFL 36**  
 5946923..... **MR 117**  
 7750754..... **MHG 20**  
 920690..... **MFL 36**  
 9462703..... **MHG 26**  
 9462703..... **MHG 41**

## JAGUAR

AV61-12A343-BA..... **MHG 11**  
 AV61-12A343-BA..... **MHG 12**  
 JD6 1138..... **MSC 6**

## LAND ROVER

AV61-12A343-BA..... **MHG 11**  
 LR004396..... **MSC 6**  
 NCJ 1001 10..... **MHG 55**

## LIEBHERR

6 060 115..... **MFL 36**

## MAGIRUS-DEUTZ

4792112..... **MHG 26**  
 4792112..... **MHG 41**

## MAN

8800 017 7..... **MFL 36**

## MAZDA

148073..... **MSC 1**  
 2S6Q9E731AA..... **MSC 1**

## MERCEDES-BENZ

000 545 3516..... **MHG 56**  
 000 545 36 16..... **MHG 57**  
 0015447432..... **MFL 35**  
 001 544 8332..... **MFL 35**  
 0015450532..... **MHG 45**  
 0015459832..... **MHG 45**  
 002 544 1432..... **MFL 35**  
 0025442832..... **MFL 35**  
 002 544 58 32..... **MFL 35**  
 0025445932..... **MFL 35**  
 002 544 6432..... **MFL 35**

## MERCEDES-BENZ

0025446632..... **MFL 35**  
 002 544 6732..... **MFL 35**  
 0025450632..... **MHG 45**  
 0025450932..... **MHG 45**  
 0035440532..... **MFL 35**  
 003 544 0632..... **MFL 35**  
 003 545 17 05..... **MHG 28**  
 003 545 24 05..... **MHG 28**  
 0055454032..... **MHG 48**  
 0065458932..... **MHG 46**  
 0065459032..... **MHG 48**  
 0075459832..... **MHG 46**  
 0075459932..... **MHG 48**  
 0135452432..... **MHG 48**  
 0195456832..... **MHG 56**  
 019 545 69 32..... **MHG 57**  
 025 545 2832..... **MHG 56**  
 025 545 29 32..... **MHG 57**  
 025 545 40 32..... **MHG 57**  
 51299029..... **MHG 57**  
 51299030..... **MHG 56**  
 646 153 65 79..... **MHG 56**  
 648 900 00 00..... **MHG 57**  
 A 000 545 3516..... **MHG 56**  
 A 000 545 36 16..... **MHG 57**  
 A0015450532..... **MHG 45**  
 A0015459832..... **MHG 45**  
 A 002 544 58 32..... **MFL 35**  
 A0025450632..... **MHG 45**  
 A0025450932..... **MHG 45**  
 A0055454032..... **MHG 48**  
 A0065458932..... **MHG 46**  
 A0065459032..... **MHG 48**  
 A0075459832..... **MHG 46**  
 A0075459932..... **MHG 48**  
 A0135452432..... **MHG 48**  
 A 019 545 69 32..... **MHG 57**  
 A 025 545 28 32..... **MHG 56**  
 A025545283264..... **MHG 56**  
 A 025 545 29 32..... **MHG 57**  
 A 028 545 40 32..... **MHG 57**  
 A4479001001..... **MHG 1**  
 A6079000100..... **MHG 14**  
 A 646 153 65 79..... **MHG 56**  
 A 646 153 84 91..... **MHG 56**  
 A 648 900 00 00..... **MHG 57**  
 A6489000100..... **MHG 57**

## NISSAN

00000992121..... **MHG 2**  
 0143600QAB..... **MSC 4**  
 -01506353-0..... **MHG 38**  
 110678071R..... **MHG 13**  
 110678071R..... **MHG 14**  
 11067 BN700..... **MHG 2**  
 -11067-D9702..... **MHG 29**  
 11067 JD50A..... **MHG 1**  
 11067 JD50A..... **MHG 2**  
 11067JD50B..... **ME 7**  
 11067JD50B..... **MHG 1**  
 11067JD50C..... **MHG 14**  
 11067JD50C..... **MHG 15**  
 23798-00QAC..... **MSC 3**  
 -25230-69T00..... **MHG 31**  
 2523080A0A..... **MHG 14**  
 2523080A0A..... **MHG 15**  
 -25230-BN300..... **MHG 20**  
 -25230-BN300..... **MHG 34**  
 -25230-D8701..... **MHG 32**  
 -25230-G2400..... **MHG 19**  
 -25230-G2400..... **MHG 33**  
 -25230-G2450..... **MHG 19**  
 -25230-G2450..... **MHG 33**  
 -25230-G2452..... **MHG 19**  
 -25230-G2452..... **MHG 33**  
 -75800005-1/2..... **MHG 26**  
 -75800005-1/2..... **MHG 41**  
 -75800011-1/2..... **MHG 42**  
 -77001-15078..... **MHG 2**  
 -78100003-0..... **MHG 39**  
 -82005-58438..... **ME 7**  
 -82005-58438..... **MHG 1**

## OPEL

1232076..... **MHG 6**  
 1232076..... **MHG 7**  
 1232077..... **MHG 8**  
 1232077..... **MHG 9**  
 1237976..... **MHG 7**  
 1237976..... **MHG 8**  
 1238532..... **MHG 40**  
 1238532..... **MHG 55**  
 1238537..... **MHG 40**  
 1238537..... **MHG 55**  
 1238539..... **MHG 16**  
 1238539..... **MR 109**  
 1238540..... **MHG 16**

# Comparison chart of vehicle manufacturers

## OPEL

1238540.....	<b>MR 109</b>
1238542.....	<b>MR 116</b>
1238549.....	<b>MHG 16</b>
1238549.....	<b>MR 109</b>
1238 550.....	<b>MT 18</b>
1238563.....	<b>MR 111</b>
1238565.....	<b>MHG 40</b>
1238565.....	<b>MHG 55</b>
1238566.....	<b>MR 111</b>
1238568.....	<b>MHG 40</b>
1238568.....	<b>MHG 55</b>
1238627.....	<b>MHG 40</b>
1238627.....	<b>MHG 55</b>
1238966.....	<b>MHG 16</b>
1238966.....	<b>MR 109</b>
4400385.....	<b>MHG 10</b>
4400385.....	<b>MHG 9</b>
4402178.....	<b>MHG 15</b>
4402178.....	<b>MHG 29</b>
4402510.....	<b>MHG 53</b>
4402560.....	<b>MSC 4</b>
4402721.....	<b>MHG 10</b>
4402721.....	<b>MHG 11</b>
4406678.....	<b>ME 7</b>
4406678.....	<b>MHG 1</b>
4409990.....	<b>MHG 2</b>
4416764.....	<b>MHG 1</b>
4416764.....	<b>MHG 2</b>
4419200.....	<b>MHG 14</b>
4419200.....	<b>MHG 15</b>
4420674.....	<b>ME 7</b>
4420674.....	<b>MHG 1</b>
4422144.....	<b>MHG 13</b>
4422144.....	<b>MHG 14</b>
4506156.....	<b>MHG 2</b>
55353011.....	<b>MHG 5</b>
55353011.....	<b>MHG 6</b>
55354141.....	<b>MHG 7</b>
55354141.....	<b>MHG 8</b>
55557760.....	<b>MHG 6</b>
55557760.....	<b>MHG 7</b>
55557761.....	<b>MHG 8</b>
55557761.....	<b>MHG 9</b>
6235240.....	<b>MHG 5</b>
6235240.....	<b>MHG 6</b>
6235303.....	<b>MHG 7</b>
6235303.....	<b>MHG 8</b>
90040992.....	<b>MHG 40</b>

## OPEL

90040992.....	<b>MHG 55</b>
90069864.....	<b>MT 18</b>
90228928.....	<b>MHG 40</b>
90228928.....	<b>MHG 55</b>
90240651.....	<b>MHG 40</b>
90240651.....	<b>MHG 55</b>
90341822.....	<b>MHG 40</b>
90341822.....	<b>MHG 55</b>
90464952.....	<b>MHG 40</b>
90464952.....	<b>MHG 55</b>
93168361.....	<b>ME 7</b>
93168361.....	<b>MHG 1</b>
93863895.....	<b>ME 7</b>
93863895.....	<b>MHG 1</b>
95516185.....	<b>MHG 13</b>
95516185.....	<b>MHG 14</b>

## PEUGEOT

145205.....	<b>MR 117</b>
1920-AW.....	<b>MSC 2</b>
1920-EH.....	<b>MSC 1</b>
38725.....	<b>MHG 56</b>
5981.10.....	<b>MHG 25</b>
5981.10.....	<b>MHG 40</b>
5981.11.....	<b>MHG 26</b>
5981.11.....	<b>MHG 41</b>
5981.13.....	<b>MHG 25</b>
5981.13.....	<b>MHG 40</b>
5981.15.....	<b>MHG 26</b>
5981.15.....	<b>MHG 41</b>
5981.15.....	<b>MHG 55</b>
5981.19.....	<b>MHG 56</b>
5981.21.....	<b>MHG 55</b>
5981.24.....	<b>MHG 54</b>
5981.26.....	<b>MHG 55</b>
5981.27.....	<b>MHG 55</b>
5981.44.....	<b>MHG 11</b>
5981.44.....	<b>MHG 12</b>
598120.....	<b>MHG 56</b>
598125.....	<b>MHG 16</b>
598125.....	<b>MHG 30</b>
598131.....	<b>MHG 16</b>
598131.....	<b>MHG 30</b>
598138.....	<b>MHG 16</b>
598138.....	<b>MHG 30</b>
598140.....	<b>MHG 1</b>
598140.....	<b>MHG 2</b>
598142.....	<b>MHG 21</b>

## PEUGEOT

598142.....	<b>MHG 36</b>
598143.....	<b>MHG 16</b>
598143.....	<b>MHG 30</b>
655522.....	<b>MHG 20</b>
655522.....	<b>MR 113</b>
655547.....	<b>MR 117</b>
79 200 765 93.....	<b>MHG 25</b>
79 200 765 93.....	<b>MHG 40</b>
9100040980.....	<b>MR 117</b>
91 515 869 80.....	<b>MHG 26</b>
91 515 869 80.....	<b>MHG 41</b>
92 508 382 80.....	<b>MHG 25</b>
92 508 382 80.....	<b>MHG 40</b>
92 508 832 80.....	<b>MHG 25</b>
92 508 832 80.....	<b>MHG 40</b>
92 508 882 80.....	<b>MHG 25</b>
92 508 882 80.....	<b>MHG 40</b>
92 515 866 80.....	<b>MHG 26</b>
92 515 866 80.....	<b>MHG 41</b>
92 515 867 80.....	<b>MHG 26</b>
92 515 867 80.....	<b>MHG 41</b>
95496621.....	<b>MHG 20</b>
95496621.....	<b>MR 113</b>
9601329480.....	<b>MR 117</b>
96141677.....	<b>MHG 56</b>
9614167780.....	<b>MHG 56</b>
96 162 800 80.....	<b>MHG 55</b>
96 165 823.....	<b>MHG 55</b>
9616582380.....	<b>MHG 55</b>
9616582480.....	<b>MHG 54</b>
96252036.....	<b>MHG 56</b>
9625203680.....	<b>MHG 56</b>
9627326180.....	<b>MR 109</b>
9636777180.....	<b>MST 1</b>
9637220880.....	<b>MSC 1</b>
9637465980.....	<b>MSC 2</b>
96 374 669 80.....	<b>MSC 1</b>
9639907380.....	<b>MHG 16</b>
9639907380.....	<b>MHG 30</b>
96 399 125 80.....	<b>MHG 16</b>
96 399 125 80.....	<b>MHG 30</b>
96 399 998 80.....	<b>MSC 2</b>
9640469680.....	<b>MHG 1</b>
9640469680.....	<b>MHG 2</b>
96 622 215 80.....	<b>MSC 6</b>
96 638 248 80.....	<b>MHG 11</b>
96 638 248 80.....	<b>MHG 12</b>
9675323280.....	<b>MSO 1</b>



# Comparison chart of vehicle manufacturers

## PEUGEOT

9999163554..... **MR 117**

## PORSCHE

95560610610..... **MSC 5**  
 95560610610..... **MSC 7**  
 95561802800..... **MHG 39**  
 95561802800..... **MHG 54**

## RENAULT

00000992121..... **MHG 2**  
 110678071R..... **MHG 13**  
 110678071R..... **MHG 14**  
 11067JD50B..... **ME 7**  
 11067JD50B..... **MHG 1**  
 271206395R..... **ME 7**  
 271206395R..... **MHG 1**  
 30872555..... **MHG 15**  
 30872555..... **MHG 29**  
 30873658..... **MHG 15**  
 30873658..... **MHG 29**  
 50 10 168 944..... **MFL 36**  
 6001546572..... **MHG 2**  
 6001548175..... **MSC 3**  
 7700100703..... **MHG 10**  
 7700100703..... **MHG 11**  
 7700101969..... **MSC 3**  
 7700101970..... **MSC 4**  
 7700102036..... **MHG 48**  
 7700103069..... **MSC 4**  
 7700107794..... **MHG 15**  
 7700107794..... **MHG 29**  
 7700109860..... **MHG 10**  
 7700109860..... **MHG 9**  
 7700111525..... **MHG 10**  
 7700111525..... **MHG 11**  
 7700115078..... **MHG 2**  
 7700702747..... **MHG 28**  
 7700715675..... **MR 116**  
 7700721268..... **MR 117**  
 7700722290..... **MHG 26**  
 7700722290..... **MHG 41**  
 7700751089..... **MHG 28**  
 7700757776..... **MHG 28**  
 7700790579..... **MHG 51**  
 7700790579..... **MHG 53**  
 7700851443..... **MHG 51**  
 7700851443..... **MHG 53**  
 7700856789..... **MHG 53**  
 7700863454..... **MHG 51**

## RENAULT

7700863626..... **MHG 48**  
 7700863626..... **MHG 57**  
 7700866727..... **MHG 57**  
 7700867374..... **MHG 51**  
 7700867558..... **MHG 15**  
 7700867558..... **MHG 29**  
 7700870715..... **MHG 50**  
 7701348734..... **MHG 53**  
 7702087784..... **MHG 28**  
 8200396919..... **MSC 3**  
 8200436025..... **MSC 3**  
 8200468645..... **MSC 3**  
 8200468645..... **MSC 4**  
 8200558438..... **ME 7**  
 8200558438..... **MHG 1**  
 8200643171..... **MSC 3**  
 -82008-59243..... **MHG 14**  
 -82008-59243..... **MHG 15**  
 9640469680..... **MHG 1**  
 9640469680..... **MHG 2**  
 NU61..... **ME 7**  
 NU61..... **MHG 1**

## ROVER

0581CR01..... **MHG 26**  
 0581CR01..... **MHG 41**  
 NCJ100110..... **MHG 55**  
 PCR5020..... **MHG 26**  
 PCR5020..... **MHG 41**  
 PRC5020..... **MHG 28**

## SAME

000871074..... **MHG 28**

## SISU

186-350-0171..... **MFL 36**

## SSANGYONG

6625453032..... **MHG 33**  
 6625453032..... **MHG 48**  
 6625453532..... **MHG 33**  
 6625453532..... **MHG 48**

## STANDARD

58940..... **MFL 23**

## SUZUKI

01.4176755..... **MFL 22**  
 3885055K00..... **MHG 21**  
 3885055K00..... **MHG 36**

## SUZUKI

55353011..... **MHG 5**  
 55353011..... **MHG 6**

## TALBOT

598111..... **MHG 26**  
 598111..... **MHG 41**  
 9121586980..... **MHG 26**  
 9121586980..... **MHG 41**  
 9251586780..... **MHG 26**  
 9251586780..... **MHG 41**  
 9251586980..... **MHG 26**  
 9251586980..... **MHG 41**  
 9614167780..... **MHG 56**  
 B515867..... **MHG 26**  
 B515867..... **MHG 41**

## VAUXHALL

091097769..... **MHG 40**  
 091097769..... **MHG 55**  
 091108750..... **MHG 40**  
 091108750..... **MHG 55**  
 4406678..... **MHG 1**  
 4420674..... **MHG 1**  
 90 040 992..... **MHG 40**  
 90 040 992..... **MHG 55**  
 90 228 928..... **MHG 40**  
 90 228 928..... **MHG 55**  
 90 341 822..... **MHG 40**  
 90 341 822..... **MHG 55**  
 91146237..... **MFL 36**  
 93168361..... **MHG 1**  
 93863895..... **MHG 1**  
 95516185..... **MHG 13**  
 95516185..... **MHG 14**

## VOLVO

1326730..... **MR 116**  
 1 421 233 4..... **MFL 36**  
 15048941..... **MFL 36**  
 1 623 180..... **MFL 36**  
 30872555..... **MHG 29**  
 30873658..... **MHG 29**  
 30873658..... **MHG 15**  
 3285227..... **MR 116**  
 35601160..... **MHG 55**  
 35601160..... **MHG 40**  
 3650116..... **MHG 55**  
 3650116..... **MHG 40**  
 5 241 022..... **MFL 22**

# Comparison chart of vehicle manufacturers

## VOLVO

8692616..... **MHG 2**

## VW GROUP

030907601..... **MSC 5**  
 030907601..... **MSC 7**  
 030907601C..... **MSC 5**  
 030907601C..... **MSC 7**  
 030907601D..... **MSC 5**  
 030907601D..... **MSC 7**  
 030907601E..... **MSC 5**  
 030907601E..... **MSC 7**  
 030907901D..... **MSC 5**  
 030907901D..... **MSC 7**  
 036 906 433..... **MSC 8**  
 036 906 433 A..... **MSC 8**  
 038907281A..... **MHG 34**  
 038907281B..... **MHG 38**  
 038907281B..... **MHG 53**  
 038907281D..... **MHG 35**  
 038907281D..... **MHG 50**  
 03D907601..... **MSC 5**  
 03D907601..... **MSC 7**  
 03G907282..... **MHG 37**  
 03G907282A..... **MHG 36**  
 03G907282A..... **MHG 51**  
 045906433A..... **MSC 8**  
 04L907282..... **MHG 37**  
 0581CR01..... **MHG 26**  
 0581CR01..... **MHG 41**  
 0581CR1..... **MHG 26**  
 0581CR1..... **MHG 41**  
 090307601E..... **MSC 5**  
 090307601E..... **MSC 7**  
 171911261..... **MHG 46**  
 171911261C..... **MHG 46**  
 191911261A..... **MHG 46**  
 191911261A/C..... **MHG 46**  
 191911261C..... **MHG 46**  
 1J0 906 381 A..... **MHG 25**  
 1J0 906 381 A..... **MR 118**  
 1J0919506M..... **MELM 3**  
 3059060591..... **MR 116**  
 321906059D..... **MR 110**  
 321906059E..... **MR 110**  
 321906059F..... **MR 110**  
 321906059G..... **MHG 22**  
 321906059G..... **MR 115**  
 321906059H..... **MHG 26**

## VW GROUP

321906059H..... **MR 119**  
 321911261C..... **MHG 46**  
 325911261..... **MHG 46**  
 357 906 381..... **MHG 19**  
 357 906 381..... **MR 112**  
 357 906 381 A..... **MHG 25**  
 357 906 381 A..... **MR 118**  
 357919506..... **MELM 2**  
 357919506A..... **MELM 2**  
 3A0919506..... **MELM 2**  
 443906059A..... **MR 110**  
 443907385..... **MR 110**  
 443907385B..... **MHG 22**  
 443907385B..... **MR 115**  
 443907385C..... **MHG 26**  
 443907385C..... **MR 119**  
 443907385G..... **MHG 26**  
 443907385G..... **MR 119**  
 443907385H..... **MHG 26**  
 443907385H..... **MR 119**  
 4439 11261..... **MHG 46**  
 443911261C..... **MHG 46**  
 443911262..... **MHG 46**  
 4E0907282A..... **MHG 39**  
 4E0907282A..... **MHG 54**  
 6Q1907521..... **MELM 4**  
 6Q1907521A..... **MELM 4**  
 6Q1907521B..... **MELM 4**  
 6Q2907521..... **MELM 5**  
 6Q2907521A..... **MELM 5**  
 6Q2907521B..... **MELM 5**  
 867911261C..... **MHG 46**  
 893911261..... **MHG 46**  
 A 37 - 3104..... **MFL 36**  
 SE138992100A..... **MHG 28**  
 X03952671..... **MHG 20**  
 X03952671..... **MR 113**



# MAHLE

MAHLE Aftermarket GmbH  
Pragstraße 26 – 46  
70376 Stuttgart  
Telefon: +49 711 501-0

[www.mahle-aftermarket.com](http://www.mahle-aftermarket.com)  
[www.mpulse.mahle.com](http://www.mpulse.mahle.com)

ISSUED FOR EUROPE