

L 400 Series

L400A/MA | L400C/LC/MC/LMC

HYUNDAI WIA Heavy Duty CNC Turning Center

Technical Leader

The CNC Turning Center L400 series, designed by Hyundai WIA with years of expertise and the latest technology, is a Turning Center that maximizes productivity and performance.

MODEL	Chuck Size			Bed		Turret		
	12"	15"	Big Bore	Standard	Long	10 Stations	12 Stations	Mill Turret
L400A	●	○		●			●	
L400MA	●	○		●			●	●
L400C		●	○	●		●		
L400LC		●	○		●	●		
L400MC		●	○	●			●	●
L400LMC		●	○		●		●	●

● : Standard ○ : Option

L 400 Series

Heavy-Duty Cutting, Large Work Capacity, CNC Turning Center

- Rigidity secured through box guideways.
- One-piece structure for high accuracy and sturdiness
- Main spindle heat displacement minimized
- Main spindle driven by 2-step gear box (L400MA : Belt)
- Optional big bore spindle is available for pipe machining (L400C series)



01 BASIC STRUCTURE

High Rigid Bed & Structure for Heavy Duty Cutting CNC Turning Center

Servo Turret

- No. of Tools : 10 [12] EA
- Tool Size (O.D./I.D.)
 - L400A Series : $\square 25/\text{Ø}50$ ($\square 1''/\text{Ø}2''$)
 - L400C Series : $\square 32/\text{Ø}50$ ($\text{Ø}1\ 1/4''/\text{Ø}2''$)
- Mill Turret : BMT75

High Precision Spindle

- L400A Series : 3,000 r/min
- L400C Series : 2,000 r/min
- L400C Series : Big Bore (Opt.)
- C-Axis Control : 0.001° ('M' Type)

Built-in Tail Stock

- Taper
 - L400A/MA/C : MT#4
 - L400MC/LMC/LC : MT#5

2-step Gear Box

L400LMC



POWERFUL CUTTING CAPABILITY & WIDE CUTTING AREA

ALL-IN-ONE TYPE OF BED

High Precision & Rigidity, One-Piece Structure

The L400 Series features a 45° slant bed design which is developed through finite element analysis (FEA) to absorb vibration and minimize thermal growth. This ensures a stabilized platform for powerful, precise cutting capabilities.

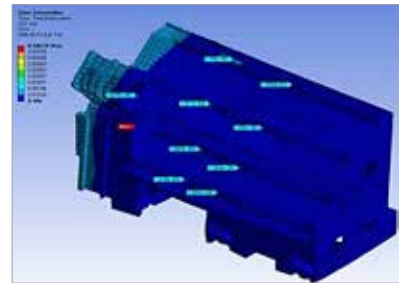

GUIDEWAY

Box Guideway

All axes of L400 Series are designed with Box Guideways for better travel ability. Box Guideways show great performance in offsetting vibrations caused by heavy duty cutting.

Ball Screw

Large diameter ball screws with preloading prevent deformation due to heat. Also double-anchor support method improves rigidity.



Travel (X/Z)

L400A/MA	L400C/MC	L400LC/LMC
325/1,205 mm (12.8"/47.4")	320/1,200 mm (12.6"/47.2")	320/2,200 mm (12.6"/86.6")

Rapid Traverse Rate (X/Z)

L400A/MA L400C/MC	L400LC/LMC
20/25 m/min (787/984 ipm)	20/20 m/min (787/787 ipm)

02 HIGH PRECISION SPINDLE

Long Lasting, High Accuracy & Excellent Performance CNC Turning Center

Spindle Specifications

■ : Standard

MODEL	Spindle Speed	Motor (Max./Cont.)	Torque (Max./Cont.)	Driving Method
L400A	3,000 rpm (FAPIUC)	26/22 kW (35/30HP)	1,325/1,120 N.m (977.3/826.1 lbf.ft)	Belt + 2 Step Gear
L400MA	3,000 rpm (FAPIUC)	30/20 kW (40/27HP)	797/585 N.m (587.8/431.5 lbf.ft)	Belt
	3,000 rpm (iTROL)	32/27 kW (43/36 HP)	786.2/663.4 N.m (579.9/489.3 lbf.ft)	
L400C	2,000 rpm (FAPIUC)	26/22 kW (35/30HP)	1,753/1,483 N.m (1,292.9/1,093.8 lbf.ft)	Belt + 2 Step Gear
	1,500 rpm (BIG BORE)	37/30 kW (50/40HP)	2,705/2,194 N.m (1,995.1/1,618.2 lbf.ft)	
	2,000 rpm (iTROL)	26.4/22 kW (35.4/30HP)	1,782/1,485 N.m (1,314.3/1,095.3 lbf.ft)	Belt (Gearless)
	2,000 rpm (FAPIUC)	30/22 kW (40/30HP)	1,612/994 N.m (1,189/733.1 lbf.ft)	
L400LC	2,000 rpm (FAPIUC)	37/30 kW (50/40HP)	3,073/2,490 N.m (2,266.5/1,836.5 lbf.ft)	Belt + 2 Step Gear
	1,500 rpm (BIG BORE)	37/30 kW (50/40HP)	2,705/2,194 N.m (1,995.1/1,618.2 lbf.ft)	
L400MC L400LMC	2,000 rpm (FAPIUC)	37/30 kW (50/40HP)	3,073/2,490 N.m (2,266.5/1,836.5 lbf.ft)	Belt + 2 Step Gear [Gearless]
	1,500 rpm (BIG BORE)	37/30 kW (50/40HP)	2,705/2,194 N.m (1,995.1/1,618.2 lbf.ft)	
	2,000 rpm (iTROL)	37.2/31 kW (50/41.6HP)	3,090/2,579 N.m (2,279/1,902.2 lbf.ft)	Belt (Gearless)
2,000 rpm (FAPIUC)	30/22 kW (40/30HP)	1,612/994 N.m (1,189/733.1 lbf.ft)		

HEAVY DUTY CUTTING & HIGH ACCURACY

MAIN SPINDLE

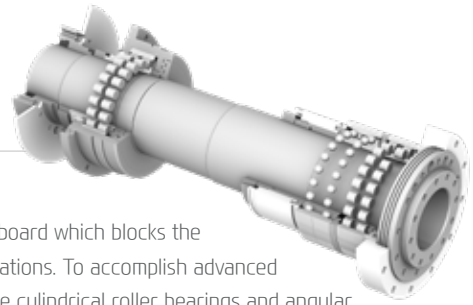

Spindle Ideal for Heavy Cutting

The thermally symmetrical headstock has a special heat insulation board which blocks the heat and maintains high accuracy during long and continuous operations. To accomplish advanced stability even during heavy duty cutting, a combination of P4 double cylindrical roller bearings and angular bearings are adopted.

The double locking device separates the spindle bearing and pulley to prevent a decrease in spindle bearing pretension during interrupted cutting, heavy duty cutting, chuck cylinder operation, and by belt pulley tension.

C-Axis Control ('M' Type)

The C axis is capable of 0.001° control when milling turret is applied. Machining capability is strengthened with turning and milling operations.

2-Step Gear Box

A two-step driving method is applied inside the main spindle as standard on non mill turrets. It provides powerful torque at low speeds and stable rotation at high speeds.

Standard feature of L400MC/LMC spindle (gear-driven) is unable to control 0.001° due to mechanical characteristic. If the contouring control is needed, please select belt-type (gearless) spindle. (L400MA : Belt-type as a standard)

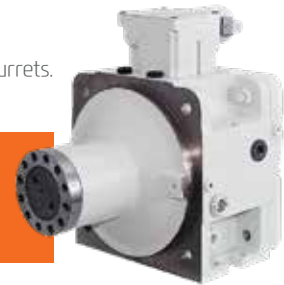

BIG BORE SPINDLE (L400C Series)

The big bore spindle of $\varnothing 181\text{mm}$ (7.1") provides excellent performance during pipe machining. Also, spindle torque of 2,705N·m(1,995.1lbf·ft) is optimal for heavy duty cutting.



OPTION

03 SERVO TURRET

High speed, High Accuracy, Highly Reliable Servo Turret

Mill Turret

[] : Power Up - Option

ITEM	Speed	Motor (Max./Cont)	Torque (Max./Cont)	Collet Size
BMT75	4,000 rpm (FANUC)	7.5/5.5 kW (10/7.5HP)	44.7/35 N·m (33/25.8 lbf·ft)	Ø26 (Ø1")/ER40
	[3,600 rpm (FANUC)]	11/7.5 kW (15/10HP)	70/47.8 N·m (51.6/35.3 lbf·ft)	
	4,000 rpm (ITROL)	7.5/6.3 kW (10/8.4HP)	71.6/60 N·m (52.8/44.3 lbf·ft)	

VARIOUS DRIVEN PRECISION BMT TOOL HOLDERS

SERVO TURRET



Servo Turret

The L400 Series' large 12-station turret provides left or right facing tools in all positions. The Bi-directional rotation turret is attached to a $\varnothing 260$ ($\varnothing 10.2''$) diameter curvic coupling and is driven by a high torque motor. 1/8,000 degree repeatability under 11 tons of clamping force enables high precision machining and heavy duty cutting.

20 Bar(290 psi) High Pressure Coolant **OPTION**

Turret is designed to utilize 20 bar (290 psi) high pressure coolant and it shows optimum performance in machining difficult-to-cut material.

MODEL	No. of Tools	Tool Size (O.D/I.D)	Indexing Time
L400A	12 EA	$\square 25/\varnothing 50$ mm ($\square 1''/\varnothing 2''$)	0.2 sec
L400C/LC	10 EA	$\square 32/\varnothing 50$ mm ($\square 1.2''/\varnothing 2''$)	

MILL TURRET

BMT75 Turret

The BMT turret secures the tool with four bolts and key on the tool mounting surface of the turret, making it possible to powerfully fix the tool, ensuring high reliability in rigidity and precision.

STRAIGHT MILLING HEAD



ANGULAR MILLING HEAD



Mill Tool Holder

Machining capability has increased with the addition of straight milling head tool holder.



04 USER CONVENIENCE

Various Devices for User Friendly

TAIL STOCK

Built-In Tail Stock

The built-in tail stock ensures high accuracy even during heavy duty cutting and can be controlled automatically or manually.

MODEL	Taper	Quill Dia.	Quill Travel
L400A/MA/C	MT#4	Ø100 mm (Ø3.9")	130 mm (5.1")
L400LC/MC/LMC	MT#5	Ø150 mm (Ø5.9")	132 mm (5.2")

❖ L400A/MA/C : MT#5 Built-In Tail Stock (Option)

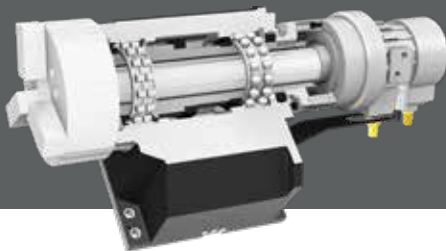

Chuck Type Tail Stock **OPTION**

When machining materials with a center hole and the use of tail stock is not possible, chuck type tail stock can be used to ensure stable machining.

Chuck Size : 10"

Spindle Speed : 3,000 rpm

Bore : Ø75 (Ø2.9")

HIGH PRECISION SYSTEM



Automatic Q-Setter

Quick and accurate tool calibration can be done by contacting the tool tip with the sensor.



Steady Rest

For long parts, such as shafts, the steady rest increases rigidity and minimizes vibration.



Linear Scale

Linear scales increase positioning accuracy and reduce distortion caused by thermal growth, thus ensuring a more accurate finished part

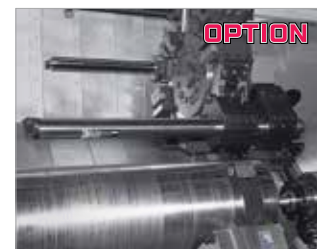

Long Boring Tool holder

When using long boring tool holder, deeper inner diameter machining is possible, enabling faster and more precise machining.

Optional

CHIP DISPOSAL SOLUTION

Chip Conveyor

Timely and effective disposal of chips will enhance productivity as well as the working environment.



Hinge	Chip Type : Roughing Chip, Long Chip, Chip complex	Material : SS41, 45C, Cast Steel	Front Right Direction
	Highly efficient when disposing a lot of chips. Capable of handling stringy chips..		
Scraper	Chip Type : Finely broken chip blown out	Material : cast Iron, Nonferrous	
	Convenient for shortly cut chips.		
❖ Screw	Chip Type : The lower portion of micro-chips	Material : Steel, Casting	
	Compresses and ejects chips to reduce chip Trouble.		
❖ Drum Filter	Chip Type : Powder, Micro Chip	Material : AL	
	Advantageous in precision, as the chips do not flow in to the coolant nozzle.		

❖ When ordering a screw or drum filter chip conveyor, prior consult with hyundai wia's sales person.

COOLANT UNIT & ECO SYSTEM



Standard Coolant (Nozzle)



Chuck Coolant (Upper Chuck)



Chuck Air Blow (Upper Chuck)



Air Gun

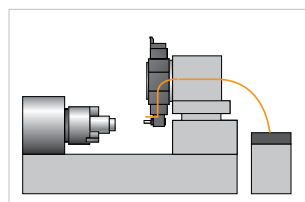

MQL : Minimal Quantity Lubrication



Oil Skimmer



Mist Collector



Grease Lubrication Device

05 HYUNDAI WIA FANUC – SMART PLUS

The Compatible All-round Control



15" Touch-type Monitor as a standard

	Fast Cycle Time Technology
Smart Machine Control	Fine Surface Technology
	Smart Servo Control Technology
Conversational Program	SmartGuide-i
i-HMI	Machining-aid Function
Part Program Storage	5120M (2MB)
No. of Registerable Programs	1000 EA



SMART SOFTWARE



Dialogue Program (Smart Guide-i)

This software offers the maximum user convenience through dialogue manipulation from setup to processing. This includes writing processing programs and simulation checks.

Convenience Function S/W

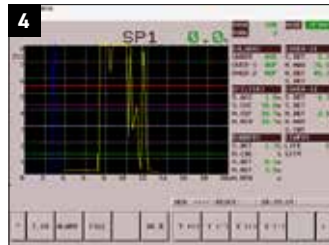

1. Thermal Displacement Compensation (HW-TDC) **OPTION**
This software improves processing precision by minimizing thermal deformation from changes in external environments and machining.

2. Machine Guidance (HW-MCG)
This software offers various user convenience functions such as tool manipulation, maintenance, tool monitoring, and a pop-up/status

3. LAUNCHER
This software offers shortcuts for quick access to specialized features and frequently used features.

4. Tool Monitoring (HW-TM) **OPTION**
This tool status monitoring software monitors and protects workpiece, tools, and equipment through real-time monitoring of the motor load from machining.

Machining Support S/W



1. Premium Tool Operation
This software offers premium graphic functions for more intuitive tool operation. (Only in iHMI tools)

2. Manual Viewer
This software enables users to view electronic manuals right from the tool. (Only in iHMI tools)

3. Scheduling
This software enables viewing/setting up directly from the tool. This allows such actions as managing customer's tool schedules and schedule notification. (Only in iHMI tools)

4. Operation Memo
This software is capable of managing customer notes such as tool information and issues. (Only in iHMI tools)

SPECIFICATIONS

Standard & Optional

Spindle		L400A	L400MA
Main Spindle	12"	●	●
Hollow Chuck 3 Jaw	15"	○	○
Main Spindle	12"	☆	☆
Solid Chuck 3 Jaw	15"	☆	☆
Standard Soft Jaw (1set)		●	●
Chuck Clamp Foot Switch		●	●
2 Steps Hyd. Pressure Device		○	○
Spindle Inside Stopper		☆	☆
Main Spindle 5° Index		☆	-
C-axis (0.001")		-	●
Cs contouring function		-	●
Chuck Open/Close Confirmation Device		●	●
2 Steps Chuck Foot Switch		○	○
Turret			
Tool Holder		●	●
12 station Turret		●	●
Mill Turret	BMT	-	●
Straight Milling Head (Radial)	Collet Type, 1ea	-	●
Angular Milling Head (Axial)	Collet Type, 1ea	-	●
Boring Sleeve		●	●
Drill Socket		●	●
U-Drill Holder		○	○
Extension Holder	For Out-Dia	●	-
Angle Head		-	☆
Tail Stock & Steady Rest			
Built-In Tail Stock		●	●
Programmable Tail Stock (MT #4)		●	●
Programmable Tail Stock (MT #5)		○	○
Manual Type Steady Rest		☆	☆
Manual Type Hyd. Steady Rest (SMW/Kan/Shinkang/Samchully)		☆	☆
Programmable Hyd. Steady Rest		○	○
Standard Dead Center		●	●
2 Steps Tail Stock Pressure System		☆	☆
Quill Forward/Reverse Confirmation Device		●	●
Tail Stock Foot Switch		●	●
Coolant & Air Blow			
Standard Coolant (Nozzle)		●	●
Chuck Coolant (Upper Chuck)		☆	☆
Gun Coolant		○	○
Through Spindle Coolant (Only for Special Chuck)		☆	☆
Thru Coolant for Live Tool		-	☆
Chuck Air Blow(Upper Chuck)		○	○
Tail Stock Air Blow (Upper Tail Stock)		☆	☆
Turret Air Blow		☆	☆
Air Gun		○	○
Through Spindle Air Blow (Only for Special Chuck)		☆	☆
High Pressure Coolant	0.4Bar (5.8psi)	●	●
	6Bar (87psi)	○	○
	20Bar (290psi)	○	○
Power Coolant System (For Automation)		☆	☆
Coolant Chiller		☆	☆
Chip Disposal			
Coolant Tank	300 ℓ (79.3 gal)	●	●
	400 ℓ (105.7 gal)	-	-
Chip Conveyor (Hinge/Scraper)	Front (Right)	○	○
	Front (Rear)	-	-
Special Chip Conveyor (Drum Filter)		☆	☆
Chip Wagon	Standard (180 ℓ [47.5 gal])	○	○
	Swing (200 ℓ [52.8 gal])	○	○
	Large Swing (290 ℓ [76.6 gal])	○	○
	Large Size (330 ℓ [87.2 gal])	○	○
Customized		☆	☆
ETC			
Tool Box		●	●
Customized Color	Need Munsell No.	☆	☆
CAD & CAM		☆	☆

● : Standard ○ : Option ☆ : Prior Consultation - : Non Applicable

Safety Device		L400A	L400MA
Total Splash Guard		●	●
Back Spin Torque Limiter (BST)		●	●
Chuck Hydraulic Pressure Maintenance Interlock		☆	☆
Electric Device			
Call Light	1Color : ●	●	●
Call Light & Buzzer	3Color : ● ● ● B	○	○
Electric Cabinet Light		○	○
Remote MPG		○	○
Workcounter	Digital	○	○
Totalcounter	Digital	○	○
Toolcounter	Digital	○	○
Multi-Tool counter	Digital	○	○
Electric Circuit Breaker		○	○
AVR (Auto Voltage Regulator)		☆	☆
Transformer	35kVA	○	-
	50kVA	-	○
Auto Power Off		○	○
Measurement			
Automatic Q-Setter		●	●
Work Close Confirmation Device (Only for Special Chuck)	TACO	☆	☆
	SMC	☆	☆
Work Setter		☆	☆
Linear Scale	X Axis	○	○
	Z Axis	○	○
Coolant Level Sensor (Only for Chip Conveyor)		☆	☆
Environment			
Air Conditioner	FANUC	○	○
	HYUNDAI-ITROL	-	●
Oil Mist Collector		☆	☆
Oil Skimmer (Only for Chip Conveyor)		○	○
MQL (Minimal Quantity Lubrication)		☆	☆
Fixture & Automation			
Auto Door		○	○
Auto Shutter (Only for Automatic System)		-	-
Sub Operation Panel		☆	☆
Bar Feeder Interface		○	○
Bar Feeder (FEDEK)		☆	☆
Extra M-Code 4ea		○	○
Automation Interface		☆	☆
I/O Extension (IIN & OUT)	16 Contact	○	○
	32 Contact	○	○
Parts Catcher		-	-
Turret Work Pusher (For Automation)		☆	☆
Hyd. Device			
Standard Hyd. Cylinder	Hollow	●	●
Standard Hyd. Unit	60bar(870psi) / 20ℓ (5.3gal)	●	●
S/W			
DNC software (HW-eDNC)		○	○
Machine Monitoring System (HW-MMS Cloud/Edge/Remote)		○	○
Machine Monitoring System & Analysis (HW-MMS Edge Plus)		☆	☆
Automation CAM program (HW-ACAM)		○	-
Conversational program (HW-DPRO)		○	○
SmartGuide-i : FANUC		● (F32i : ○)	● (F32i : ○)
Thermal Displacement Compensation (HW-TDC)		○	○
Tool Monitoring (HW-TM) : FANUC		○	○
Machine Guidance (HW-MCG) : FANUC		●	●
Energy Saving System (HW-ESS) : FANUC		●	●
Premium Tool Operation : FANUC		● (F32i : -)	● (F32i : -)
Manual Viewer : FANUC		● (F32i : -)	● (F32i : -)
Scheduling : FANUC		● (F32i : -)	● (F32i : -)
Operation Memo : FANUC		● (F32i : -)	● (F32i : -)

❖ 4 channel of TDC(Thermal Displacement Compensation) device is recommended, when more than 6 bar of high pressure coolant is applied, for the high quality machining.

Prior consultation is required when applying spindle contouring control for gear driven spindle. Specifications are subject to change without notice for improvement.

SPECIFICATIONS

Standard & Optional

Spindle		L400C/LC	L400MC/LMC
Main Spindle Hollow Chuck 3 Jaw	15"	●	●
	18" (Big Bore)	○	○
	21" (Big Bore)	○	○
Main Spindle Solid Chuck 3 Jaw	15"	☆	☆
Standard Soft Jaw (1set)		●	●
Chuck Clamp Foot Switch		●	●
2 Steps Hyd. Pressure Device		○	○
Spindle Inside Stopper		☆	☆
Main Spindle 5° Index		☆	-
C-axis (0.001")		-	●
Cs contouring function		-	☆
Chuck Open/Close Confirmation Device		●	●
2 Steps Chuck Foot Switch		○	○
Turret			
Tool Holder		●	●
12 station Turret		-	●
10 station Turret		●	-
Mill Turret	BMT	-	●
Straight Milling Head (Radial)	Collet Type, 1ea	-	●
Angular Milling Head (Axial)	Collet Type, 1ea	-	●
Boring Sleeve		●	●
Drill Socket		●	●
U-Drill Holder		○	○
Extension Holder	For Out-Dia	●	-
Angle Head		-	☆
Tail Stock & Steady Rest			
Built-In Tail Stock		●	●
Programmable Tail Stock (MT #4)		● / -	-
Programmable Tail Stock (MT #5)		○ / ●	●
Manual Type Steady Rest		☆	☆
Manual Type Hyd. Steady Rest (SMW/Kan/Shinkang/Samchully)		☆	☆
Programmable Hyd. Steady Rest		○	○
Standard Dead Center		●	●
2 Steps Tail Stock Pressure System		☆	☆
Quill Forward/Reverse Confirmation Device		●	●
Tail Stock Foot Switch		●	●
Coolant & Air Blow			
Standard Coolant (Nozzle)		●	●
Chuck Coolant (Upper Chuck)		☆	☆
Gun Coolant		○	○
Through Spindle Coolant (Only for Special Chuck)		☆	☆
Thru Coolant for Live Tool		-	☆
Chuck Air Blow(Upper Chuck)		○	○
Tail Stock Air Blow (Upper Tail Stock)		☆	☆
Turret Air Blow		☆	☆
Air Gun		○	○
Through Spindle Air Blow (Only for Special Chuck)		☆	☆
High Pressure Coolant	0.4Bar (5.8psi)	●	●
	6Bar (87psi)	○	○
	20Bar (290psi)	○	○
Power Coolant System (For Automation)		☆	☆
Coolant Chiller		☆	☆
Chip Disposal			
Coolant Tank	300 ℓ (79.3 gal)	●/-	●/-
	400 ℓ (105.7 gal)	-/●	-/●
Chip Conveyor (Hinge/Scraper)	Front (Right)	○	○
Special Chip Conveyor (Drum Filter)		☆	☆
Chip Wagon	Standard (180 ℓ [47.5 gal])	○	○
	Swing (200 ℓ [52.8 gal])	○	○
	Large Swing (290 ℓ [76.6 gal])	○	○
	Large Size (330 ℓ [87.2 gal])	○	○
	Customized	☆	☆
ETC			
Tool Box		●	●
Customized Color	Need Munsell No.	☆	☆
CAD & CAM		☆	☆

● : Standard ○ : Option ☆ : Prior Consultation - : Non Applicable

Safety Device		L400C/LC	L400MC/LMC
Total Splash Guard		●	●
Back Spin Torque Limiter (BST)		●	●
Chuck Hydraulic Pressure Maintenance Interlock		☆	☆
Electric Device			
Call Light	1Color : ●	●	●
Call Light & Buzzer	3Color : ●, ●, ● B	○	○
Electric Cabinet Light		○	○
Remote MPG		○	○
Workcounter	Digital	○	○
Totalcounter	Digital	○	○
Toolcounter	Digital	○	○
Multi-Tool counter	Digital	○	○
Electric Circuit Breaker		○	○
AVR (Auto Voltage Regulator)		☆	☆
Transformer	40KVA	○/-	-
	50KVA	-/○	-
	60KVA	-	○
Auto Power Off		○	○
Measurement			
Q-Setter		-	-
Automatic Q-Setter		●	●
Work Close Confirmation Device (Only for Special Chuck)	TACO	☆	☆
	SMC	☆	☆
Work Setter		☆	☆
Linear Scale	X Axis	○	○
	Z Axis	○	○
Coolant Level Sensor (Only for Chip Conveyor)		☆	☆
Environment			
Air Conditioner	FANUC	○	○
	HYUNDAI-ITROL	●	●
Oil Mist Collector		☆	☆
Oil Skimmer (Only for Chip Conveyor)		○	○
MQL (Minimal Quantity Lubrication)		☆	☆
Fixture & Automation			
Auto Door		○	○
Auto Shutter (Only for Automatic System)		-	-
Sub Operation Pannel		☆	☆
Bar Feeder Interface		○	○
Bar Feeder (FEDEK)		☆	☆
Extra M-Code 4ea		○	○
Automation Interface		☆	☆
I/O Extension (IN & OUT)	16 Contact	○	○
	32 Contact	○	○
Parts Catcher		-	-
Turret Work Pusher (For Automation)		☆	☆
Hyd. Device			
Standard Hyd. Cylinder	Hollow	●	●
Standard Hyd. Unit	60bar(870psi) / 20 ℓ (5.3gal)	●	●
S/W			
DNC software (HW-eDNC)		○	○
Machine Monitoring System (HW-MMS Cloud/Edge/Remote)		○	○
Machine Monitoring System & Analysis (HW-MMS Edge Plus)		☆	☆
Automation CAM program (HW-ACAM)		○	-
Conversational program (HW-DPRO)		○	○
SmartGuide-i : FANUC		● (F32i : ○)	● (F32i : ○)
Thermal Displacement Compensation (HW-TDC)		○	○
Tool Monitoring (HW-TM) : FANUC		○	○
Machine Guidance (HW-MCG) : FANUC		●	●
Energy Saving System (HW-ESS) : FANUC		●	●
Premium Tool Operation : FANUC		● (F32i : -)	● (F32i : -)
Manual Viewer : FANUC		● (F32i : -)	● (F32i : -)
Scheduling : FANUC		● (F32i : -)	● (F32i : -)
Operation Memo : FANUC		● (F32i : -)	● (F32i : -)

◆ 4 channel of TDC(Thermal Displacement Compensation) device is recommended, when more than 6 bar of high pressure coolant is applied, for the high quality machining.

Prior consultation is required when applying spindle contouring control for gear driven spindle.
Specifications are subject to change without notice for improvement.

SPECIFICATIONS

Spindle Output/Torque Diagram

L400A 3,000 rpm

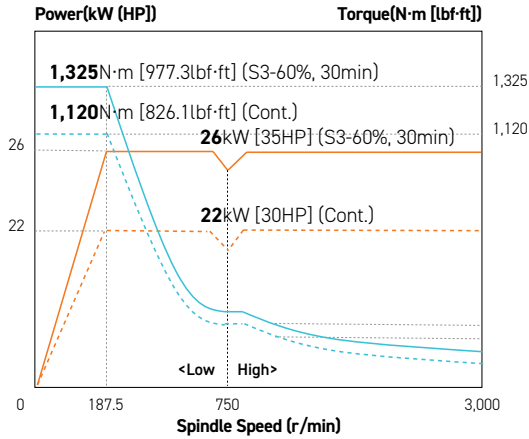

L400MA 3,000 rpm

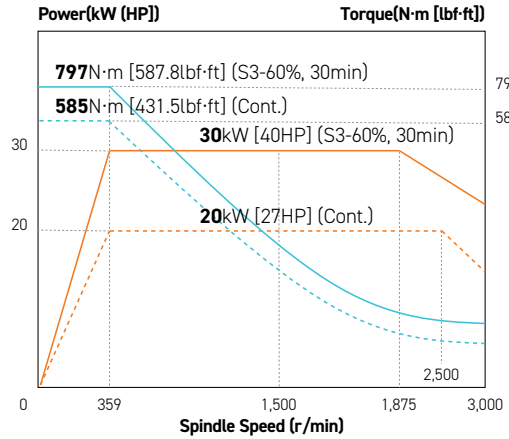

L400C 2,000 rpm

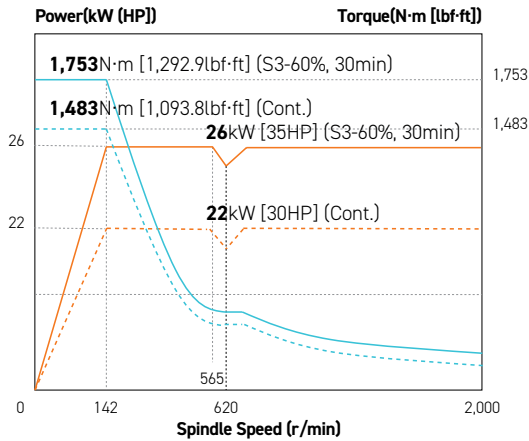

L400MC/LC/LMC 2,000 rpm

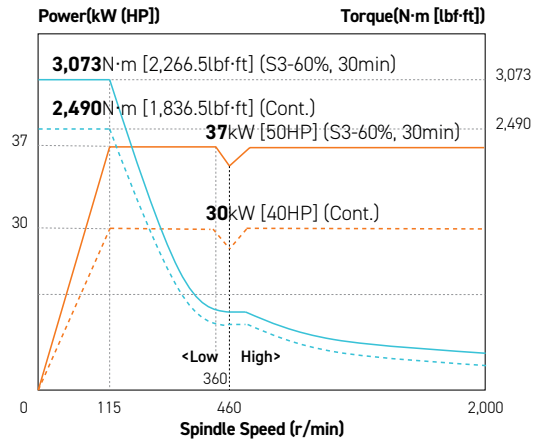

L400C Series 1,500 rpm (Big Bore)

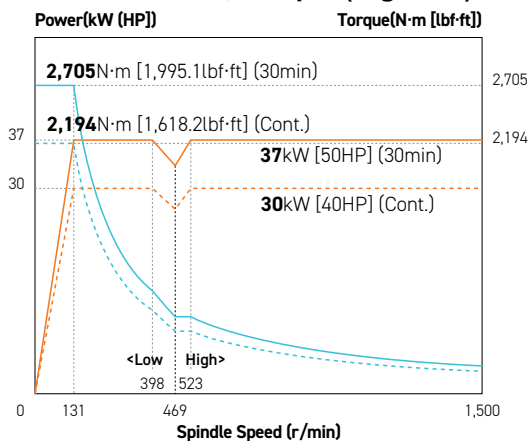

L400C Series 2,000 rpm (Gearless)

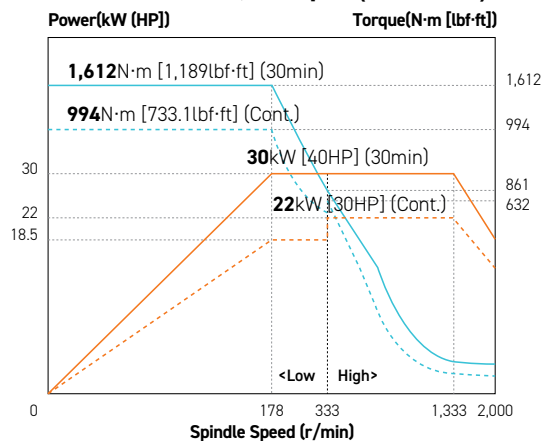

SPECIFICATIONS

Spindle Output/Torque Diagram

L400MA 3,000 rpm (iTROL)

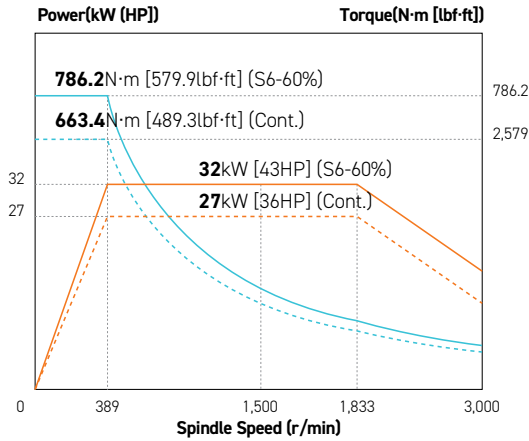

Turn Mill 4,000 rpm

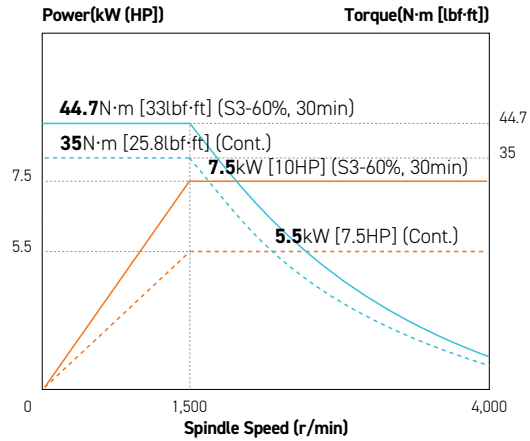

L400C 2,000 rpm (iTROL)

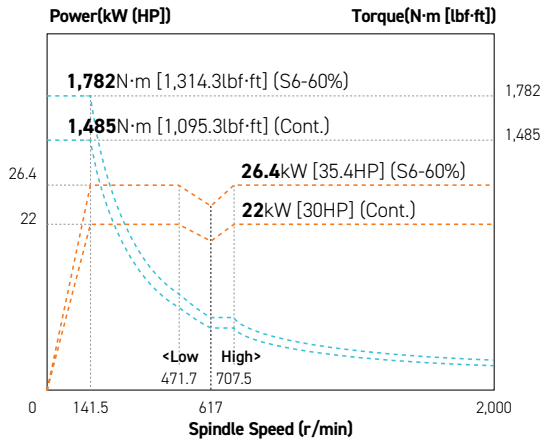

Turn Mill 3,600 rpm (High Power)

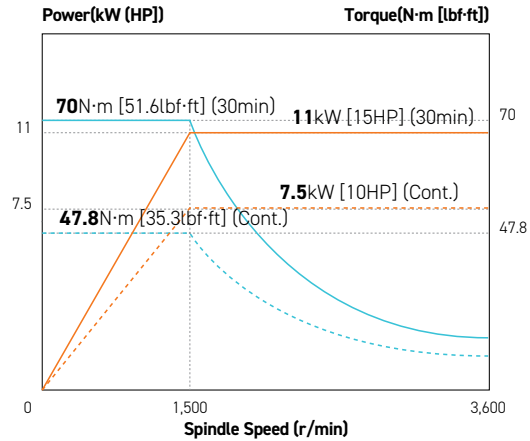

L400MC/LMC 2,000 rpm (iTROL)

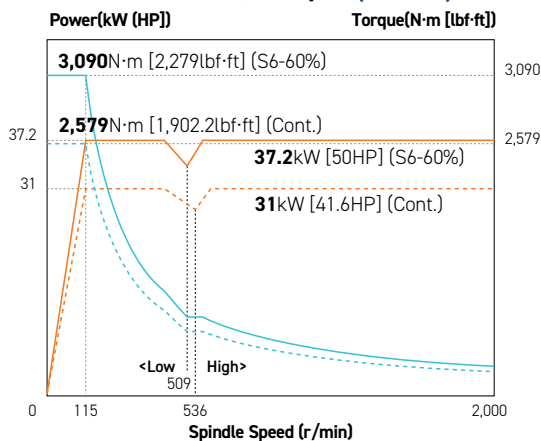

Turn Mill 4,000 rpm (iTROL)

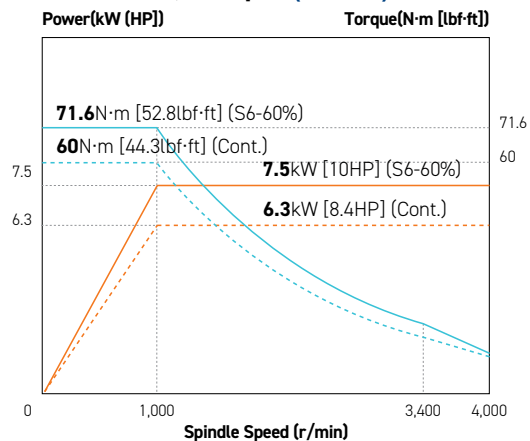

SPECIFICATIONS

External Dimensions

unit : mm(in)

L400A/MA/C/MC

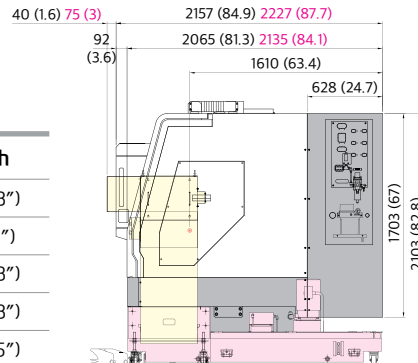
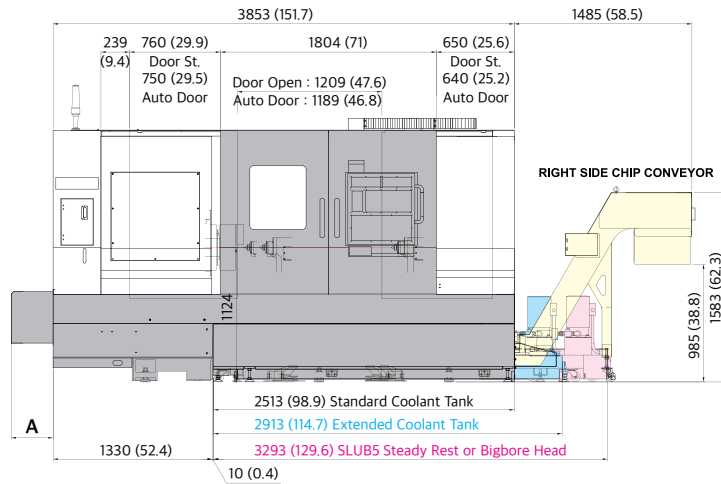
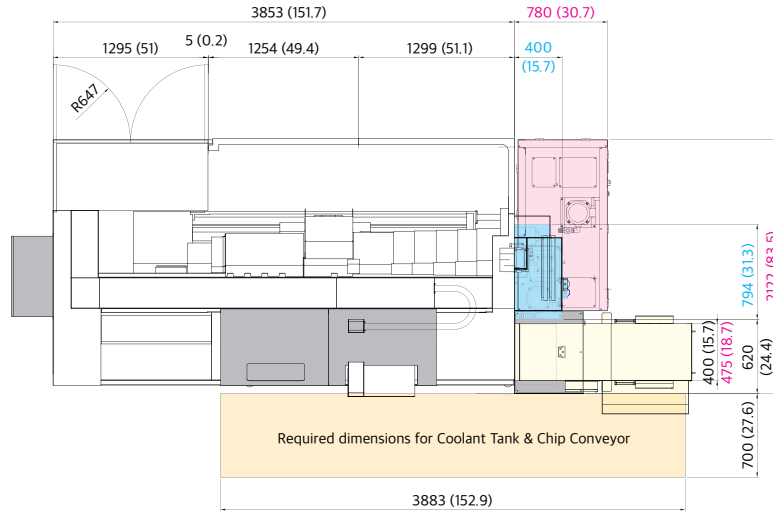

ITEM	'A' Length
L400A	350 mm (13.8")
L400MA	FANUC 165 mm (6.5")
	iTROL 350 mm (13.8")
L400C	350 mm (13.8")
L400MC	520 mm (20.5")

- Standard Coolant Tank : SLUA4 Steady Rest or 4.5 Bar Coolant
- Extended Coolant Tank : SLUA4 Steady Rest or All Coolant + Oil Skimmer, Gun Coolant
- SLUB5 Steady Rest or Big Bore Head + All Coolant + Oil Skimmer, Gun Coolant

SPECIFICATIONS

External Dimensions

unit : mm(in)

L400LC/LMC (SLUB5 Steady Rest Application)

 : Expand Type Coolant Tank

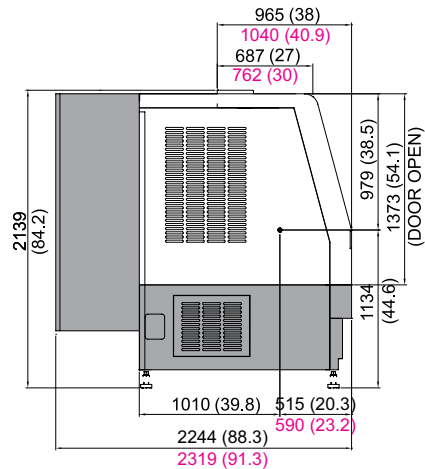
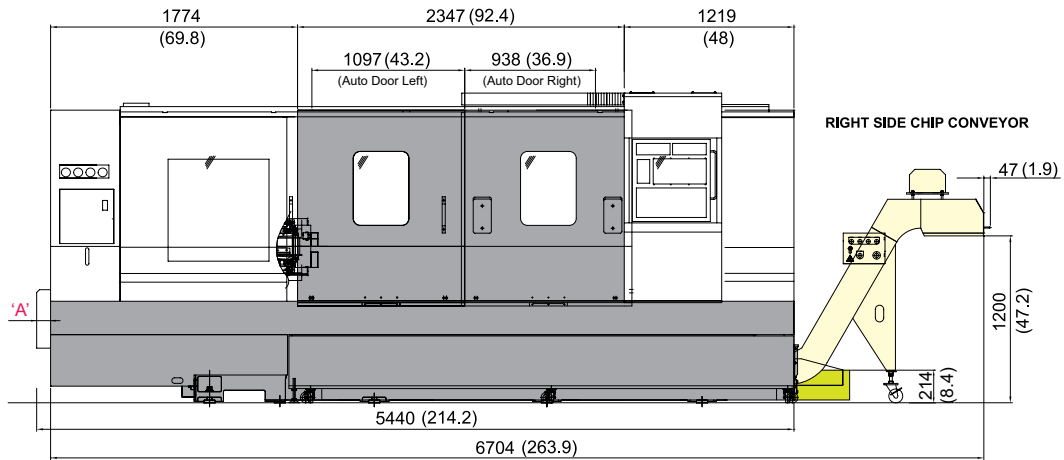
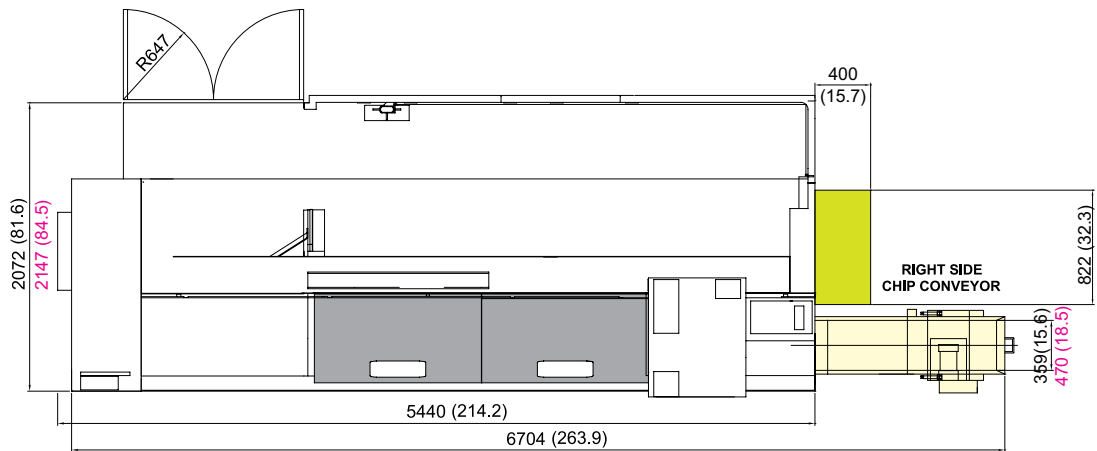

'A' Length

unit : mm(in)

ITEM	Fanuc	HYUNDAI-ITROL	FANUC + Bigbore
L400LC	167 (6.6)	200 (7.9)	300 (11.8)
L400LMC			

SPECIFICATIONS

Interference

unit : mm(in)

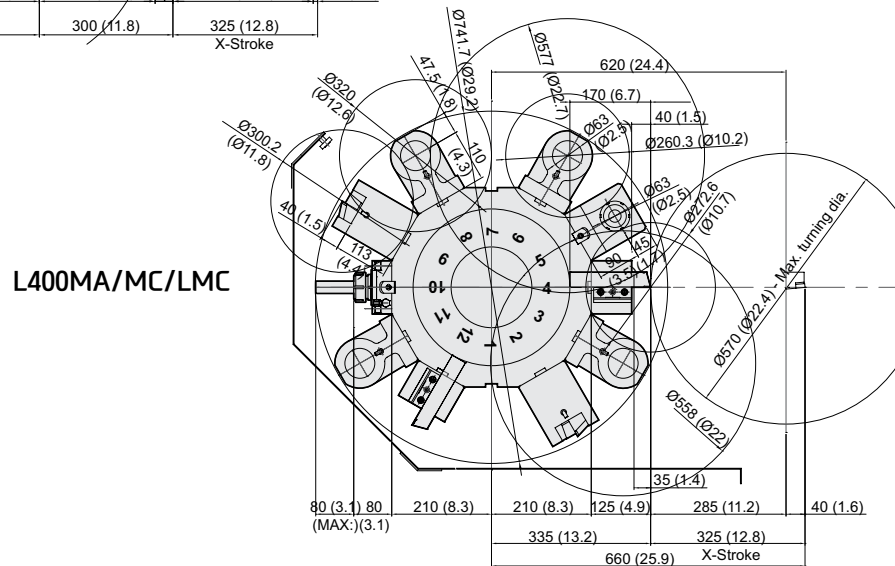
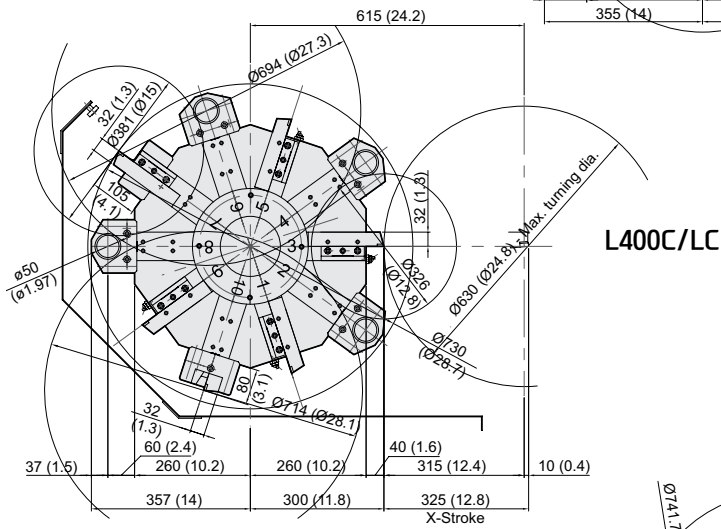
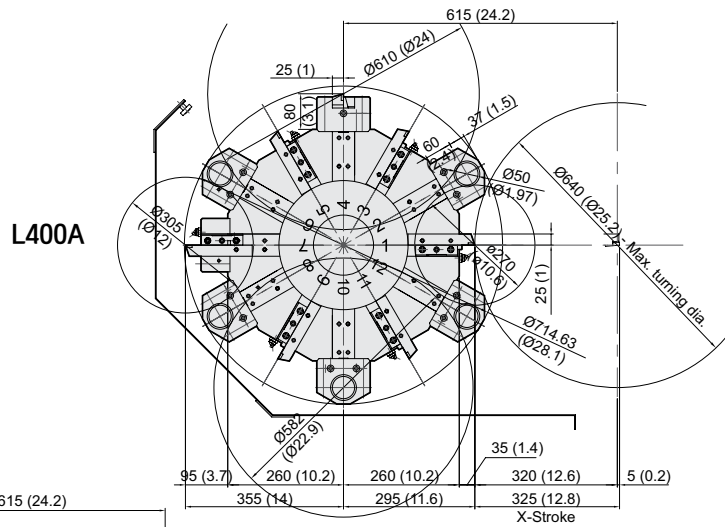

SPECIFICATIONS

Tooling System

unit : mm(in)

L400A

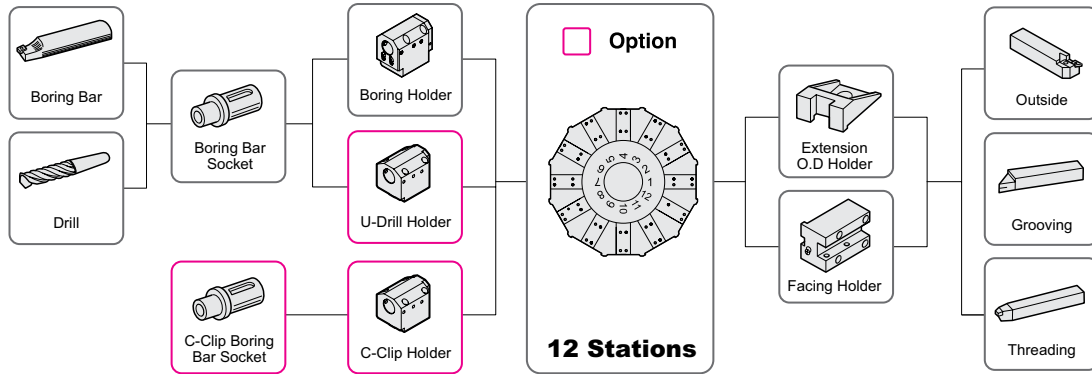

Tooling Parts Detail

ITEM			L400A	
			mm Unit	inch Unit
Turning Holder	O.D Holder	Right/Left	-	-
		Extension	1	1
	Facing Holder		1	1
Boring Holder	I.D Holder	Single	5	5
	U-Drill Holder	Tool Holder	Opt.	Opt.
	C-Clip Holder		Opt.	Opt.
Driven Holder	Straight Mill Holder	Standard	-	-
	Angular Mill Holder	Standard	-	-
Socket	Boring	Ø16 (Ø5/8")	1	1
		Ø20 (Ø3/4")	1	1
		Ø25 (Ø1")	1	1
		Ø32 (Ø1 1/4")	1	1
		Ø40 (Ø1 1/2")	1	1
	C-CLIP Boring (Opt.)	Ø16 (Ø5/8")	Opt.	Opt.
		Ø20 (Ø3/4")	Opt.	Opt.
		Ø25 (Ø1")	Opt.	Opt.
		Ø32 (Ø1 1/4")	Opt.	Opt.
		Ø40 (Ø1 1/2")	Opt.	Opt.
	Drill	MT 2	-	-
		MT 3	1	1
		MT 4	-	-

Specifications are subject to change without notice for improvement.

SPECIFICATIONS

Tooling System

unit : mm(in)

L400C/LC

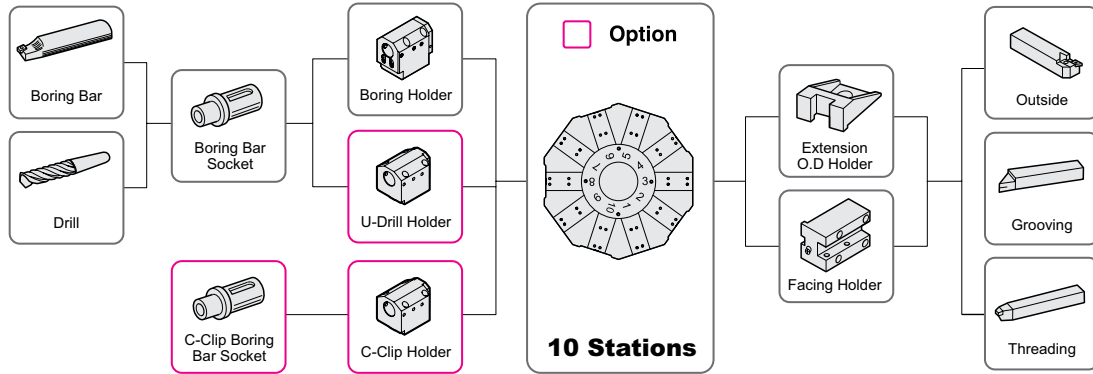

Tooling Parts Detail

ITEM			L400C/LC		
			mm Unit	inch Unit	
Turning Holder	O.D Holder	Right/Left	-	-	
		Extension	1	1	
	Facing Holder		1	1	
Boring Holder	I.D Holder	Single	4	4	
	U-Drill Holder	Tool Holder	Opt.	Opt.	
	C-Clip Holder		Opt.	Opt.	
Driven Holder	Straight Mill Holder	Standard	-	-	
	Angular Mill Holder	Standard	-	-	
Socket	Boring	Ø16 (Ø5/8")	1	1	
		Ø20 (Ø3/4")	1	1	
		Ø25 (Ø1")	1	1	
		Ø32 (Ø1 1/4")	1	1	
		Ø40 (Ø1 1/2")	1	1	
	C-CLIP Boring (Opt.)	Ø16 (Ø5/8")	Opt.	Opt.	
		Ø20 (Ø3/4")	Opt.	Opt.	
		Ø25 (Ø1")	Opt.	Opt.	
		Ø32 (Ø1 1/4")	Opt.	Opt.	
		Ø40 (Ø1 1/2")	Opt.	Opt.	
	Drill	MT 2		-	-
		MT 3		1	1
		MT 4		-	-

SPECIFICATIONS

Tooling System

unit : mm(in)

L400MA/MC/LMC

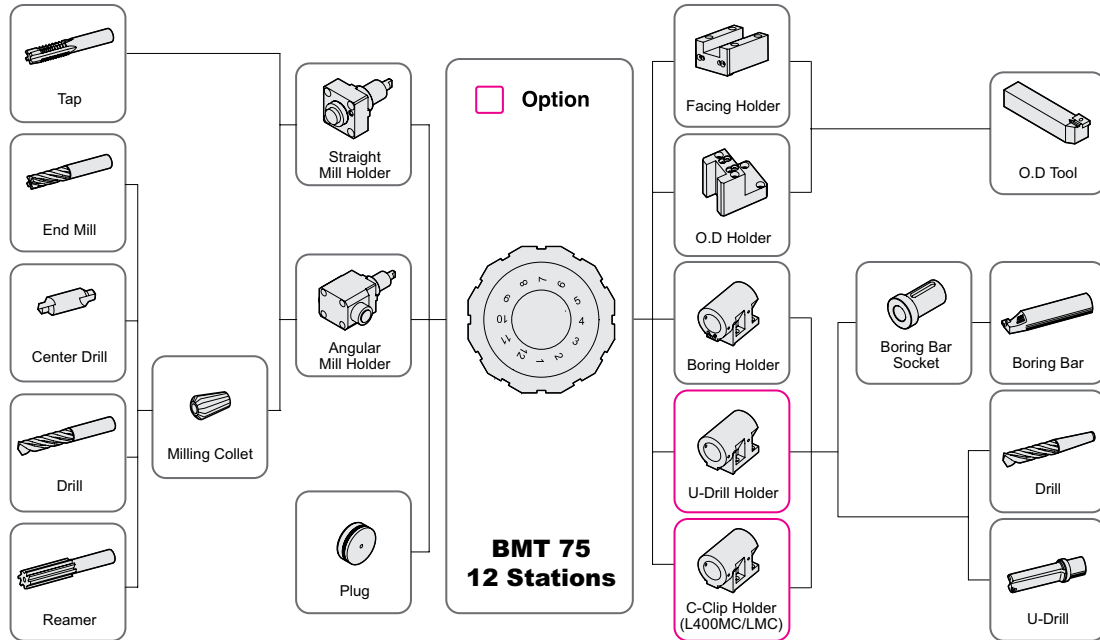

Tooling Parts Detail

ITEM			L400MA		L400MC		L400LMC	
			mm Unit	inch Unit	mm Unit	inch Unit	mm Unit	inch Unit
Turning Holder	O.D Holder	Right/Left	2	2	2	2	2	2
	Facing Holder		2	2	2	2	2	2
Boring Holder	I.D Holder	Single	4	4	4	4	4	4
	U-Drill Holder	Tool Holder	Opt.	Opt.	Opt.	Opt.	Opt.	Opt.
	C-Clip Holder		-	-	Opt.	Opt.	Opt.	Opt.
Driven Holder	Straight Mill Holder	Standard	1	1	1	1	1	1
		TTC (Tool through Coolant)	Opt.	Opt.	Opt.	Opt.	Opt.	Opt.
	Angular Mill Holder	Standard	1	1	1	1	1	1
		TTC (Tool through Coolant)	Opt.	Opt.	Opt.	Opt.	Opt.	Opt.
Socket	Boring	Long	-	-	Opt.	Opt.	-	-
		Ø16 (5/8")	1	1	-	-	-	-
		Ø20 (3/4")	1	1	1	1	1	1
		Ø25 (1")	1	1	1	1	1	1
		Ø32 (1 1/4")	1	1	1	1	1	1
		Ø40 (1 1/2")	1	1	1	1	1	1
	Drill	Ø50 (2")	-	-	1	1	1	1
		MT 2	Opt.	Opt.	-	-	-	-
		MT 3	1	1	1	1	1	1
		MT 4	Opt.	Opt.	Opt.	Opt.	Opt.	Opt.

Specifications are subject to change without notice for improvement.

SPECIFICATIONS

Interference

unit : mm(in)

L400A (■ : MT#5)

OD Turning Holder

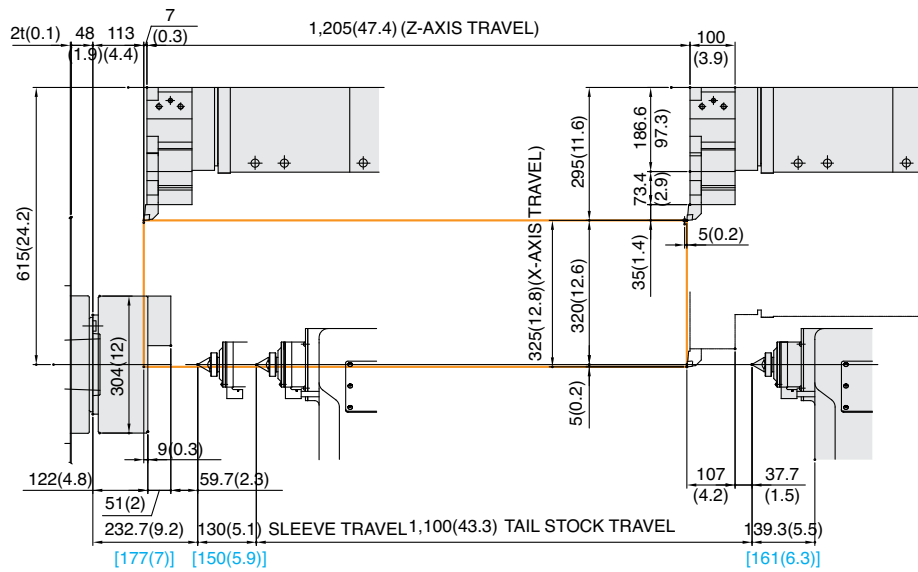

Boring Bar Holder

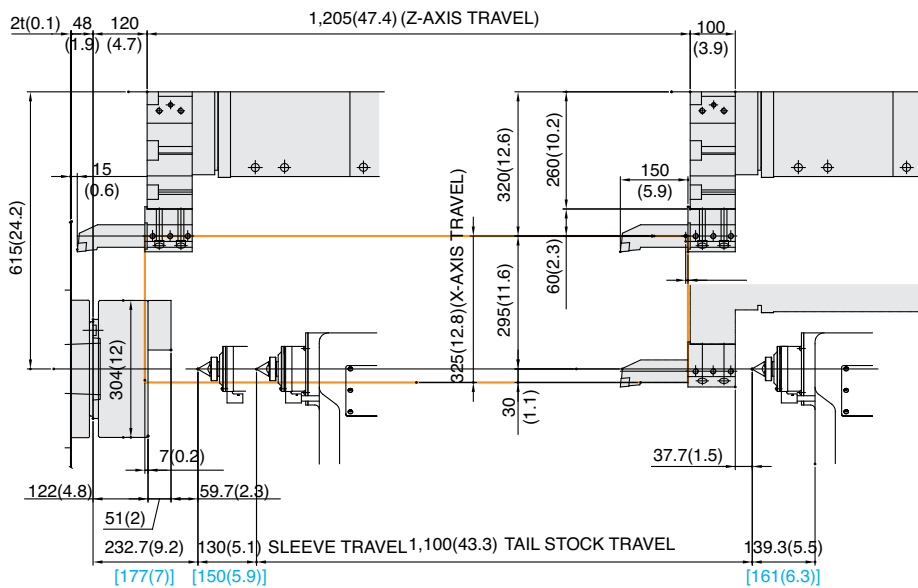

SPECIFICATIONS

Tooling Travel Range

unit : mm(in)

L400C (■ : MT#5)
L400LC

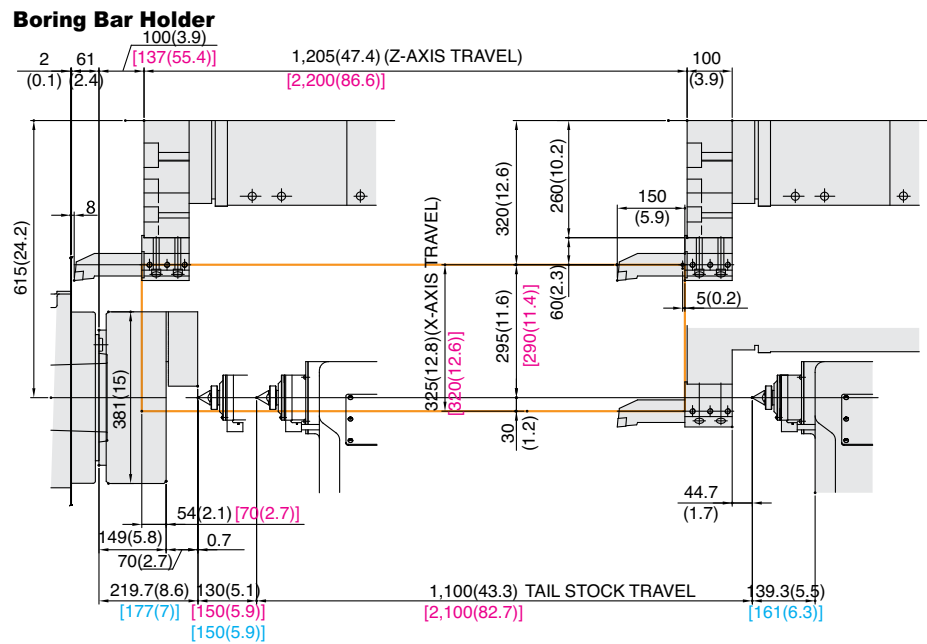
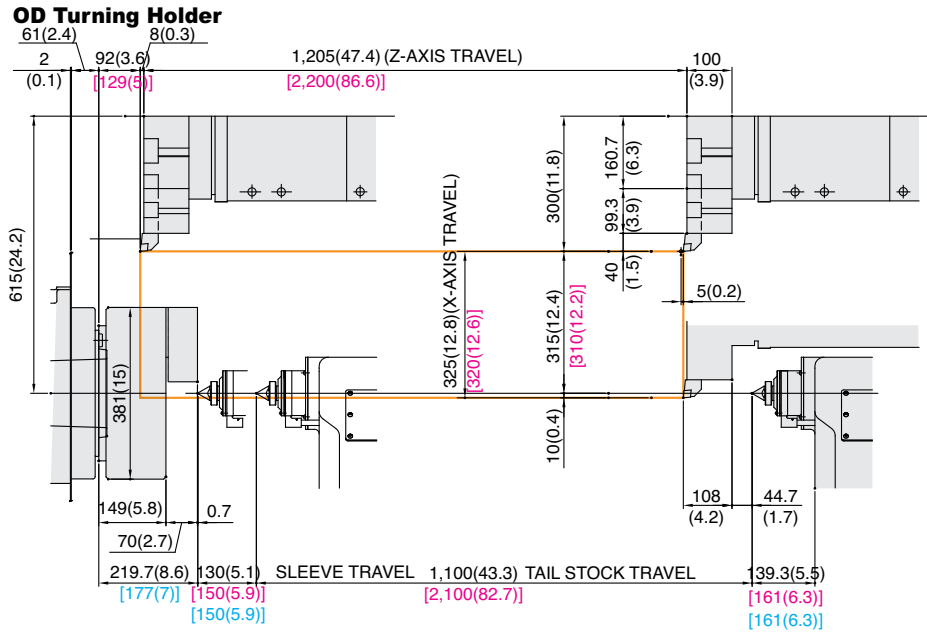

SPECIFICATIONS

Interference

unit : mm(in)

L400MA/MC {Big Bore} (■ : MT#5)

L400LMC {Big Bore}

OD Turning Holder

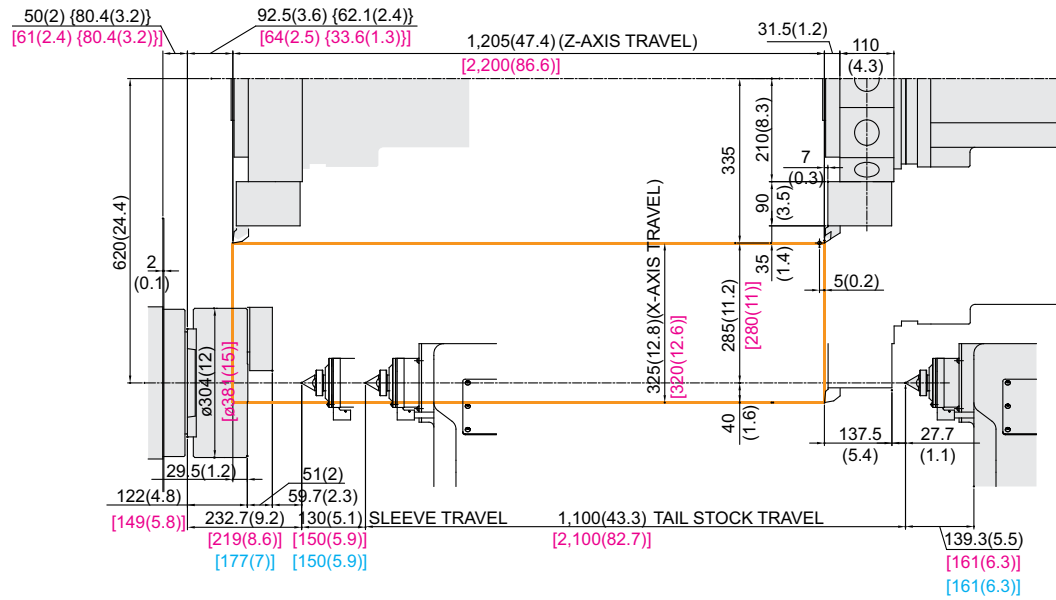

Boring Bar Holder

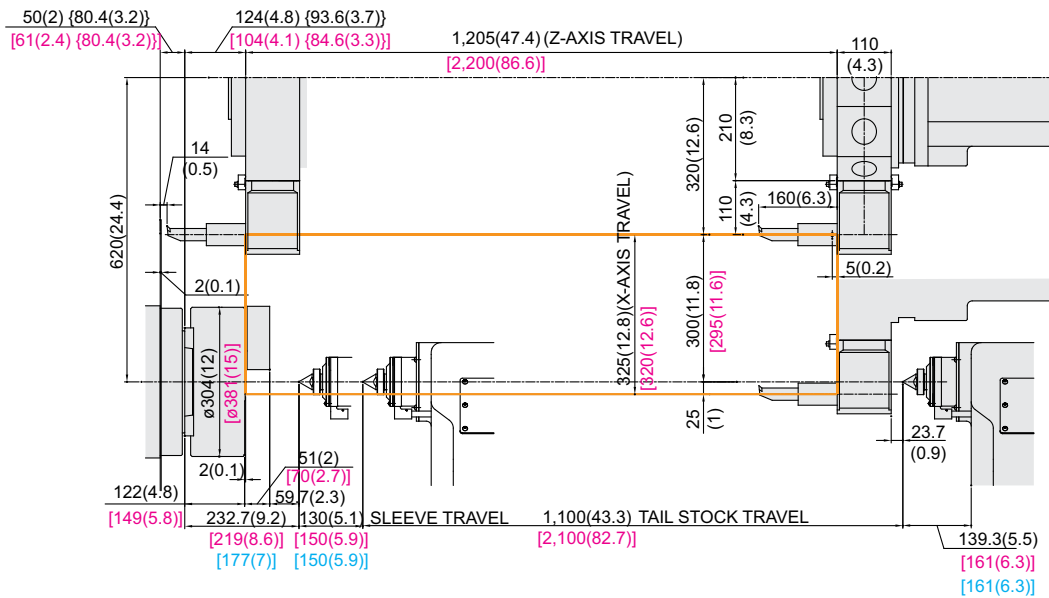

SPECIFICATIONS

Tooling Travel Range

unit : mm(in)

L400MA/MC {Big Bore} (■: MT#5)
L400LMC {Big Bore}

Straight Milling Head

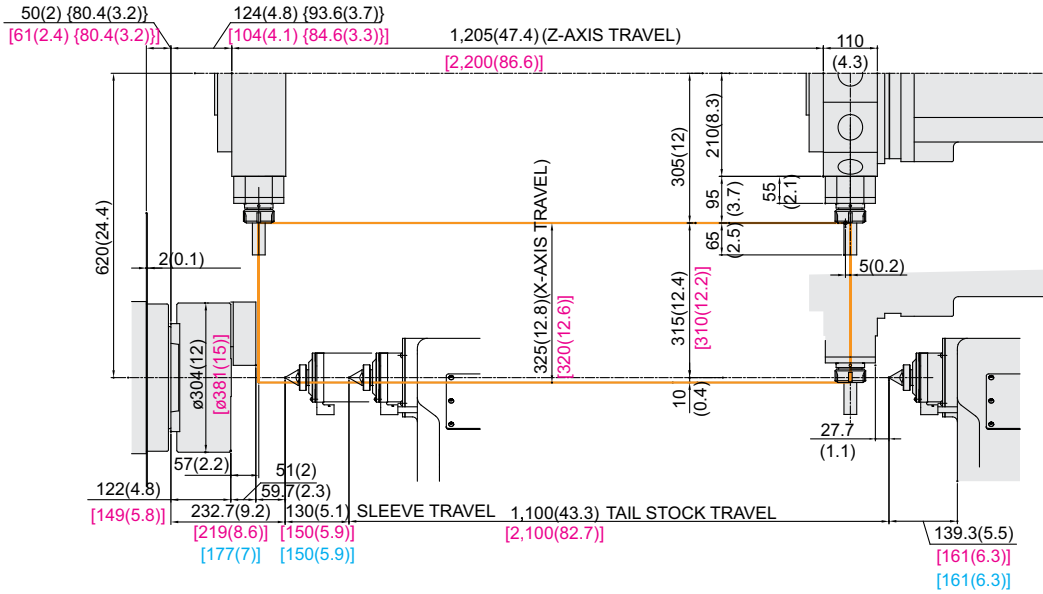

Angular Milling Head

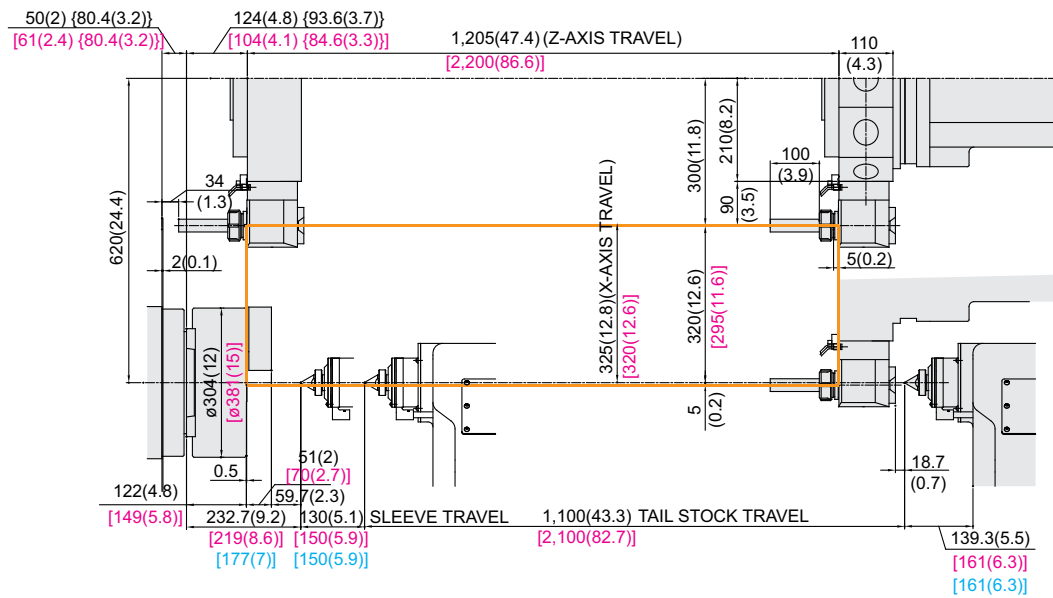

SPECIFICATIONS

Specifications

[] : Option ■ Live Tool Motor Power Up ■ iTROL

ITEM		L400A	L400MA
CAPACITY	Swing Over the Bed	Ø780 (30.7")	
	Swing Over the Carriage	Ø535 (21.1")	
	Max. Turning Dia.	Ø640 (25.2")	Ø570 (22.4")
	Max. Turning Length	1,180 (46.5")	
	Bar Capacity	Ø90 (3.5")	
SPINDLE	Chuck Size	12" [15"]	
	Spindle Bore	Ø104 (4.1")	
	Spindle Nose	A2-8	
	C-axis Indexing	-	0.001°
FEED	Travel (X/Z)	325/1,205 (12.8"/47.4")	
	Rapid Traverse Rate (X/Z)	20/25	
	Slide Type	BOX GUIDE	
TURRET	No. of Tools	12	
	Tool Size	□ 25 (1")/Ø50 (2")	
	Indexing Time	0.2	
LIVE TOOL	Motor (Max./Cont.)	-	7.5/5.5 (10/7.4) [11/7.5 (14.8/10)] [7.5/6.3 (10/8.4)]
	Milling Tool Speed (rpm)	-	4,000 [3,600] [4,000]
	Torque (Max./Cont.)	-	44.7/35 (33/25.8) [70/47.8 (51.6/35.3)] [71.6/60 (52.8/44.3)]
	Collet Size	-	Ø26(1") (ER40)
	Type	-	BMT75
TAIL STOCK	Taper	MT#4 (Built-in) [MT#5 (Built-in)]	
	Quill Dia.	Ø100 (3.9") [Ø150 (5.9")]	
	Quill Travel	130 (5.1") [132 (5.2")]	
	Travel	1,100 (43.3")	
TANK CAPACITY	Coolant Tank	300 (79.3)	
	Lubricating Tank	2 (0.5)	
POWER SUPPLY	Electric Power Supply	29	40
	Thickness of Power Cable	Over 50	
	Voltage	220/60 (200/50*)	
MACHINE	Floor Space (L×W)	4,203×2,065 [Big Bore : 2,135] (165.5"×81.3" [Big Bore : 84.1"])	4,018 [4,203]×2,065 [Big Bore : 2,135] (158.2" [165.5"]×81.3" [Big Bore : 84.1"])
	Height	2,153 (84.8")	
	Weight	8,500 (18,739)	
PC	Controller	H/W FANUC i Series- Smart Plus [FANUC 32i-B]	FANUC 32i-B [H/W FANUC i Series- Smart Plus] [iTROL]

Spindle

ITEM	Speed r/min	Power (Max./Cont.)	Torque (Max./Cont.)	Spindle Type
L400A	3,000 rpm (FANUC)	26/22 kW (35/30 HP)	1,325/1,120 N-m (977.3/826.1 lbf.ft)	BELT+2STEP GEAR
L400MA	3,000 rpm (FANUC)	30/20 KW (40/27 HP)	797/585 N-m (587.8/431.5 lbf.ft)	BELT
	[3,000 rpm (iTROL)]	[32/27 KW (43/36.2 HP)]	[786.2/663.4 N-m (579.9/489.3 lbf.ft)]	

*) Using 50Hz voltage instead of 60Hz may lower the output of motors. (excluding servo motors and inverter motors)

Prior consultation is required when applying spindle contouring control for gear driven spindle. / Specifications are subject to change without notice for improvement.

SPECIFICATIONS

Specifications

[] : Option

ITEM		L400C	L400LC
CAPACITY	Swing Over the Bed	mm(in) Ø780 (30.7")	Ø725 (28.5")
	Swing Over the Carriage	mm(in) Ø535 (21.1")	
	Max. Turning Dia.	mm(in) Ø630 (24.8")	
	Max. Turning Length	mm(in) 1,170 (46.1")	2,120 (83.5")
	Bar Capacity	mm(in) Ø117 (4.6") [Big Bore : Ø165.5 (6.5")]	
SPINDLE	Chuck Size	inch 15" [Big Bore : 18"/21"]	
	Spindle Bore	mm(in) Ø130 (5.1") [[Big Bore : Ø181(7.1")]	
	Spindle Nose	- A2-11 [Big Bore : A2-15]	
	C-axis Indexing	deg -	
FEED	Travel (X/Z)	mm(in) 325/1,205 (12.8"/47.4")	320/2,200 (12.6"/86.6")
	Rapid Traverse Rate (X/Z)	m/min 20/25	20/20
	Slide Type	-	BOX GUIDE
TURRET	No. of Tools	EA 10	
	Tool Size	O.D./I.D. mm(in) □ 32 (1.2")/Ø50 (2")	
	Indexing Time	sec/step 0.2	
TAIL STOCK	Taper	- MT#4 (Built-in) [MT#5 (Built-in)]	MT#5 (Built-in)
	Quill Dia.	mm(in) Ø100 (3.9") [Ø150 (5.9")]	Ø150 (5.9")
	Quill Travel	mm(in) 130 (5.1") [132 (5.2")]	132 (5.2")
	Travel	mm(in) 1,100 (43.3")	2,100 (82.7")
TANK CAPACITY	Coolant Tank	ℓ (gal) 300 (79.3)	400 (105.7)
	Lubricating Tank	ℓ (gal) 2 (0.5)	4 (1.1)
POWER SUPPLY	Electric Power Supply	kVA 33	40
	Thickness of Power Cable	Sq Over 50	
	Voltage	V/Hz 220/60 (200/50*)	
MACHINE	Floor Space (L×W)	mm(in) 4,203×2,065 [Big Bore : 2,135 (165.5"×81.3" [Big Bore : 84.1")]	5,440×2,244 (214.2"×88.3")
	Height	mm(in) 2,153 (84.8")	2,139 (84.2")
	Weight	kg(lb) 8,500 (18,739)	11,000 (24,250)
PC	Controller	- H/W FANUC i Series- Smart Plus [FANUC 32i-B] [iTROL]	H/W FANUC i Series- Smart Plus [FANUC 32i-B]

Spindle

■ : Big Bore

ITEM	Speed r/min	Power (Max./Cont.)	Torque (Max./Cont.)	Spindle Type
L400C	2,000 rpm (FANUC)	26/22 kW (35/30 HP)	1,753/1,483 N·m (1,292.9/1,093.8 lbf.ft)	BELT+2STEP GEAR
	[1,500 rpm (FANUC)]	[37/30 kW (50/40 HP)]	[2,705/2,194 N·m (1,995.1/1,618.2 lbf.ft)]	
	[2,000 rpm (iTROL)]	[26.4/22 kW (35.4/30 HP)]	[1,782/1,485 N·m (1,314.3/1,095.3 lbf.ft)]	
	[2,000 rpm (FANUC)]	[30/22 kW (40/35 HP)]	[1,612/994 N·m (1,189/733.1 lbf.ft)]	BELT (GEARLESS)
L400LC	2,000 rpm (FANUC)	37/30kW (50/40 HP)	3,073/2,490 N·m (2,266.5/1,836.5 lbf.ft)	BELT+2STEP GEAR
	[1,500 rpm (FANUC)]	[37/30 kW (50/40 HP)]	[2,705/2,194 N·m (1,995.1/1,618.2 lbf.ft)]	

*) Using 50Hz voltage instead of 60Hz may lower the output of motors. (excluding servo motors and inverter motors)

Prior consultation is required when applying spindle contouring control for gear driven spindle.

Specifications are subject to change without notice for improvement.

SPECIFICATIONS

Specifications

[] : Option ■ Live Tool Motor Power Up ■ iTROL

ITEM		L400MC	L400LMC
CAPACITY	Swing Over the Bed	mm(in)	Ø780 (30.7")
	Swing Over the Carriage	mm(in)	Ø535 (21.1")
	Max. Turning Dia.	mm(in)	Ø560 (22")
	Max. Turning Length	mm(in)	1,180 (46.5")
	Bar Capacity	mm(in)	Ø117 (4.6") [Big Bore : Ø165.5 (6.5")]
SPINDLE	Chuck Size	inch	15" [Big Bore : 18"/21"]
	Spindle Bore	mm(in)	Ø130 (5.1") [[Big Bore : Ø181(7.1")]
	Spindle Nose	-	A2-11 [Big Bore : A2-15]
	C-axis Indexing	deg	0.001°
FEED	Travel (X/Z)	mm(in)	320/1,200(12.6"/47.2")
	Rapid Traverse Rate (X/Z)	m/min	20/25
	Slide Type	-	BOX GUIDE
TURRET	No. of Tools	EA	12
	Tool Size	O.D/I.D	mm(in)
	Indexing Time	sec/step	0.2
LIVE TOOL	Motor (Max/Cont.)	kW(HP)	7.5/5.5 (10/7.4) [11/7.5 (14.8/10)] [7.5/6.3 (10/8.4)]
	Milling Tool Speed (rpm)	r/min	4,000 [3,600] [4,000]
	Torque (Max/Cont.)	N·m(lbf·ft)	44.7/35 (33/25.8) [70/47.8 (51.6/35.3)] [71.6/60 (52.8/44.3)]
	Collet Size	mm(in)	Ø26(1") (ER40)
	Type	-	BMT75
TAIL STOCK	Taper	-	MT#5 (Built-in)
	Quill Dia.	mm(in)	Ø150 (5.9")
	Quill Travel	mm(in)	132 (5.2")
	Travel	mm(in)	1,100 (43.3")
TANK CAPACITY	Coolant Tank	ℓ (gal)	300 (79.3)
	Lubricating Tank	ℓ (gal)	2 (0.5)
POWER SUPPLY	Electric Power Supply	kVA	46
	Thickness of Power Cable	Sq	Over 50
	Voltage	V/Hz	220/60 (200/50*)
MACHINE	Floor Space (L×W)	mm(in)	4,373×2,065 [Big Bore : 2,135] (172.2"×81.3" [Big Bore : 84.1"])
	Height	mm(in)	2,153 (84.8")
	Weight	kg(lb)	8,500 (18,739)
PC	Controller	-	FANUC 32i-B [H/W FANUC i Series - Smart Plus] [iTROL]

Spindle

■ : Big Bore

ITEM	Speed r/min	Power (Max./Cont.)	Torque (Max./Cont.)	Spindle Type
L400MC L400LMC	2,000 rpm (FANUC)	37/30 kW (50/40 HP)	3,073/2,490 N·m (2,266.5/1,836.5 lbf.ft)	BELT+2STEP GEAR
	[1,500 rpm (FANUC)]	[37/30 kW (50/40 HP)]	[2,705/2,194 N·m (1,995.1/1,618.2 lbf.ft)]	
	[2,000 rpm (iTROL)]	[37.2/31 (50/41.6 HP)]	[3,090/2,579 N·m (2,279/1,902.2 lbf.ft)]	
	[2,000 rpm (FANUC)]	[30/22 kW (40/35 HP)]	[1,612/994 N·m (1,189/733.1 lbf.ft)]	BELT (GEARLESS)

*) Using 50Hz voltage instead of 60Hz may lower the output of motors. (excluding servo motors and inverter motors)

Prior consultation is required when applying spindle contouring control for gear driven spindle. / Specifications are subject to change without notice for improvement.

CONTROLLER

HYUNDAI WIA FANUC i Series – Smart Plus

[] : Option

Controlled axis / Display / Accuracy Compensation	
Control axes	2 axes (X, Z) / 3 axes (X, Z, C) / 4 axes (X,Z,Y,C) 5 axes (X, Z, B, C, A) / 6 axes (X, Z, Y, B, C, A) 7 axes (X1/Z1, X2/Z2, B2, C1/C2)
Simultaneously controlled axes	2 axes [Max. 4 axes]
Designation of spindle axes	3 axes [Max. 4 axes]
Least setting Unit	X, Z, Y, B axes : 0.001 mm (0.0001 inch) C, A axes : 0.001 deg
Least input increment	X, Z, Y, B axes : 0.001 mm (0.0001 inch) C, A axes : 0.001 deg
Inch / Metric conversion	G20 / G21
High response vector control	
Interlock	All axes / Each axis
Machine lock	All axes
Backlash compensation	± 0~9999 pulses (exc. Rapid traverse / Cutting feed)
Position switch	
LCD / MDI	15 inch LCD unit (with Touch Panel)
Feedback	Absolute motor feedback
Stored stroke check 1	Over travel
Stored stroke check 2, 3	
PMC axis control	
Operation	
Automatic operation (Memory)	
MDI operation	
DNC operation	Needed DNC software / CF card
Program restart	
Wrong operation prevention	
Program check function	Dry run
Single block	
Search function	Program Number / Sequence Number
Interpolation functions	
Nano interpolation	
Positioning	G00
Linear interpolation	G01
Circular interpolation	G02, G03
Exact stop mode	Single : G09, Continuous : G61
Dwell	G04, 0 ~ 9999.9999 sec
Skip	G31
Reference position return	1st reference : G28, 2nd reference : G30 Ref. position check : G27
Thread synchronous cutting	G33
Thread cutting retract	
Variable lead thread cutting	
Multi / Continuous threading	
Feed function / Acc. & Dec. control	
Manual feed	Rapid traverse Jog : 0~2,000 mm/min (79 ipm) Manual handle : x1, x10, x100 pulses Reference position return
Cutting Feed command	Direct input F code
Feedrate override	0 ~ 200% (10% Unit)
Rapid traverse override	1%, F25%, 50%, 100%
Override cancel	
Feed per minute	G98
Feed per revolution	G99
Look-ahead block	1 block
Program input	
Tape Code	EIA / ISO
Optional block skip	9 ea
Program stop / end	M00, M01 / M02, M30
Maximum command unit	± 999,999.999 mm (± 99,999.9999 inch)
Plane selection	X-Y : G17 / Z-X : G18 / Y-Z : G19
Workpiece coordinate system	G52, G53, 6 pairs (G54 ~ G59)
Manual absolute	Fixed ON
Programmable data input	G10
Sub program call	10 folds nested
Custom macro	#100 ~ #199, #500 ~ #999
G code system	A, B/C
Programmable mirror image	G51.1, G50.1
G code preventing buffering	G4.1
Direct drawing dimension program	Including Chamfering / Corner R
Conversational Program	SmartGuide-i

Program input	
Multiple repetitive cycles	I, II
Canned cycle for turning	
Auxiliary function / Spindle speed function	
Auxiliary function	M & 4 digit
Level-up M Code	High speed / Multi / Bypass M code
Spindle speed function	S & 5 digit, Binary output
Spindle override	0% ~ 150% (10% Unit)
Multi position spindle orientation	M19 (S##)
Rigid tapping	
Constant surface speed control	G96, G97
Tool function / Tool compensation	
Tool function	T & 2 digit + Offset 2 digit
Tool life management	
Tool offset pairs	128 pairs
Tool nose radius compensation	G40, G41, G42
Geometry / Wear compensation	
Direct input of offset measured B	
Editing function	
Part program storage size	5,120m (2MB)
No. of registerable programs	1,000 ea
Program protect	
Background editing	
Extended part program editing	Copy, move and change of NC program
Memory card program edit	
Data input / output & Interface	
I/O interface	CF card, USB memory Embedded Ethernet interface
Screen hard copy	
External message	
External key input	
External workpiece number search	
Automatic data backup	
Setting, display and diagnosis	
Self-diagnosis function	
History display & Operation	Alarm & Operator message & Operation
Run hour / Parts count display	
Maintenance information	
Actual cutting feedrate display	
Display of spindle speed / T code	
Graphic display	
Operating monitor screen	Spindle / Servo load etc.
Power consumption monitoring	Spindle & Servo
Spindle / Servo setting screen	
Multi language display	Support 24 languages
Display language switching	Selection of 5 optional Languages
LCD Screen Saver	Screen saver
Unexpected disturbance torque	BST (Back spin torque limit)
Function for machine type	
Cs contour control (C & A axes)	Mill, MS, Y, SY, LF-Mill, TTMS, TTSY
Polar coordinate interpolation	Mill, MS, Y, SY, LF-Mill, TTMS, TTSY
Cylindrical interpolation	Mill, MS, Y, SY, LF-Mill, TTMS, TTSY
Polygon turning (2 Spindles)	Mill, MS, Y, SY, LF-Mill, TTMS, TTSY
Canned cycle for drilling	Mill, MS, Y, SY, LF-Mill, TTMS, TTSY
Spindle orientation expansion	MS, SY, TTS, TTMS, TTSY
Spindle synchronous control	MS, SY, TTS, TTMS, TTSY
Torque control	MS, SY, TTS, TTMS, TTSY
Y axis offset	Y, SY, TTSY
Arbitrary angular control	Y, SY, TTSY
Composite / Superimposed control	MS, SY, TTS, TTMS, TTSY
Balance cutting	TTS, TTMS, TTSY
Option	
Fast ethernet	Needed option board
Data server	Needed option board
Protection of data at 8 levels	
Tool offset pairs	200 pairs
Helical interpolation	
Optional block skip	40 ea, 200 ea (AICC II)

Figures in inch are converted from metric values.

The FANUC controller specifications are subject to change based on the policy of company CNC supplying.

CONTROLLER

FANUC 32i-B

[] : Option

Controlled axis / Display / Accuracy Compensation	
Control axes	2 axes (X, Z) / 3 axes (X, Z, C) / 4 axes (X, Z, Y, C) 5 axes (X, Z, B, C, A) / 6 axes (X, Z, Y, B, C, A)
Simultaneously controlled axes	2 axes [Max. 4 axes]
Designation of spindle axes	4 axes (1 path), 6 axes (2 path Total)
Least setting Unit	X, Z, Y, B axes : 0.001 mm (0.0001 inch) C, A axes : 0.001 deg
Least input increment	X, Z, Y, B axes : 0.001 mm (0.0001 inch) C, A axes : 0.001 deg
Inch / Metric conversion	G20 / G21
High response vector control	
Interlock	All axes / Each axis
Machine lock	All axes
Backlash compensation	± 0 ~ 9999 pulses (Rapid traverse / Cutting feed)
Position switch	
LCD / MDI	10.4 inch color LCD
Feedback	Absolute motor feedback
Stored stroke check 1	Over travel
Stored stroke check 2, 3	
PMC axis control	
Operation	
Automatic operation (Memory)	
MDI operation	
DNC operation	Needed DNC software / CF card
Program restart	
Wrong operation prevention	
Program check function	Dry run, Program check
Single block	
Search function	Program Number / Sequence Number
Interpolation functions	
Nano interpolation	
Positioning	G00
Linear interpolation	G01
Circular interpolation	G02, G03
Exact stop mode	Single : G09, Continuous : G61
Dwell	G04, 0 ~ 9999.9999 sec
Skip	G31
Reference position return	1st reference : G28 2nd reference : G30 Ref. position check : G27
Thread synchronous cutting	
Thread cutting retract	
Variable lead thread cutting	
Multi / Continuous threading	
Feed function / Acc. & Dec. control	
Manual feed	Rapid traverse Jog : 0~2,000 mm/min (79 ipm) Manual handle : x1, x10, x100 pulses Reference position return
Cutting Feed command	Direct input F code
Feedrate override	0 ~ 200% (10% Unit)
Rapid traverse override	F1%, F25%, 50%, F100%
Override cancel	
Feed per minute	G98
Feed per revolution	G99
Look-ahead block	1 block
Program input	
Tape Code	EIA / ISO
Optional block skip	1 ea
Program stop / end	M00, M01 / M02, M30
Maximum command unit	± 999,999.999 mm (± 99,999.9999 inch)
Plane selection	X-Y : G17 / Z-X : G18 / Y-Z : G19
Workpiece coordinate system	G52, G53, 6 pairs (G54 ~ G59)
Manual absolute	Fixed ON
Programmable data input	G10
Sub program call	10 folds nested
Custom macro	#100 ~ #149, #500 ~ #549
G code system	A
Programmable mirror image	G51.1, G50.1
G code preventing buffering	G4.1
Multiple repetitive cycles I, II	

Program input	
Canned cycle for turning	
Manual Guide i	Conversational auto program
Auxiliary function / Spindle speed function	
Auxiliary function	M 4 digit
Level-up M Code	High speed / Multi / Bypass M code
Spindle speed function	S 4 digit, Binary output
Spindle override	0% ~ 150% (10% Unit)
Multi position spindle orientation	M19
Rigid tapping	
Constant surface speed control	G96, G97
Tool function / Tool compensation	
Tool function	T 2 digit + Offset 2 digit
Tool life management	
Tool offset pairs	32 pairs
Tool nose radius compensation	G40, G41, G42
Geometry / Wear compensation	
Direct input of offset measured B	
Editing function	
Part program storage size	640m (256KB)
No. of registerable programs	500 ea
Program protect	
Background editing	
Extended part program editing	Copy, move and change of NC program
Memory card program edit	
Data input / output & Interface	
I/O interface	RS 232C serial port, CF card, USB memory Embedded Ethernet interface
Screen hard copy	
External message	
External key input	
External workpiece number search	
Automatic data backup	
Setting, display and diagnosis	
Self-diagnosis function	
History display & Operation	Alarm & Operator message & Operation
Run hour / Parts count display	
Maintenance information	
Actual cutting feedrate display	
Display of spindle speed / T code	
Graphic display	
Operating monitor screen	Spindle / Servo load etc.
Power consumption monitoring	Spindle & Servo
Spindle / Servo setting screen	
Multi language display	Support 20 languages
Display language switching	Selection of 5 optional Languages
LCD Screen Saver	Screen saver
Unexpected disturbance torque	BST (Back spin torque limit)
Function for machine type	
Cs contour control (C & A axes)	Mill, MS, Y, SY, LF-Mill, TTMS, TTSY
Polar coordinate interpolation	Mill, MS, Y, SY, LF-Mill, TTMS, TTSY
Cylindrical interpolation	Mill, MS, Y, SY, LF-Mill, TTMS, TTSY
Canned cycle for drilling	Mill, MS, Y, SY, LF-Mill, TTMS, TTSY
Spindle orientation expansion	MS, SY TTS, TTMS, TTSY
Spindle synchronous control	MS, SY TTS, TTMS, TTSY
Torque control	MS, SY TTS, TTMS, TTSY
Y axis offset	Y, SY, TTSY
Arbitrary angular control	Y, SY, TTSY
Composite / Superimposed control	MS, SY TTS, TTMS, TTSY
Balance cutting	MS, SY TTS, TTMS, TTSY
Option	
Additional optional block skip	9 ea
Fast ethernet	Needed option board
Data server	Needed option board
Protection of data at 8 levels	
Tool offset pairs	64 pairs / 99 pairs / 200 pairs
Part program storage size	1280 m (512KB) / 2560m (1MB)
Polygon turning (2 Spindles)	Mill, MS, Y, SY, LF-Mill, TTMS, TTSY
Helical interpolation	
Dynamic graphic display	
Direct drawing dimension program	Including Chamfering / Corner R

Figures in inch are converted from metric values.

The FANUC controller specifications are subject to change based on the policy of company CNC supplying.

CONTROLLER

HYUNDAI-iTROL (SIEMENS 828D)

[] : Option ☆ Needed technical consultation

Controlled axis / Display / Accuracy Compensation	
Control axes	2 axes (X, Z) – Std.
	3 axes (X, Z, C) – Mill
	4 axes (X, Z, Y, C) – Y
	5 axes (X, Z, B, C, A) – MS
	6 axes (X, Z, Y, B, C, A) – SY
Simultaneously controlled axes	Max. 4 axes
Least setting Unit	X, Z, Y, B axes : 0.001 mm (0.0001 inch)
	C, A axes : 1 deg [0.001] deg
Least input increment	X, Z, Y, B axes : 0.001 mm (0.0001 inch)
	C, A axes : 1 deg [0.001] deg
Inch / Metric changeover	G70 (inch) / G71 (metric)
Interlock	All axes / Each axis
Backlash compensation	
Pitch error compensation	Leadscrew pitch error compensation
LCD / MDI	10.4 inch color LCD [15 inch color LCD (With Touch panel)]
Keyboard	QWERTY full keyboard
Stored stroke check	Over travel
Operation	
Automatic operation	
MDI operation	
Program restart	
Program check function	Dry run / Program check / Machine lock
Single block	
Block search	Block search
Reposition	
Working area limit	Working area limitations
Interpolation functions	
Positioning	G00
Linear interpolation	G01
	Circular interpolation CW (G02) Circular interpolation CCW (G03)
Circular interpolation	Single block exact stop (G09)
	Exact stop G60 (G601, G602, G603)
Exact position stop	
Dwell	Dwell (G04)
Reference position return	Return to reference point
	Return to 2nd reference point
Helical interpolation	
Thread synchronous cutting	
Thread cutting retract	
Spline interpolation	Non-uniform rational B splines
Feed function / Acc. & Dec. control	
Manual feed	Rapid traverse
	Jog
	Manual handle : x1, x10, x100 pulses
	Reference position return
Cutting Feed command	Direct input F code
Feedrate override	0 ~ 200% (10% Unit)
Rapid traverse override	1%, 25%, 50%, 100%
Feed per minute	G94
Feed per revolution	G95
Look-ahead block	1 block
Program input	
ISO support	G291 (ISO)/G290 (SIEMENS)
	(ISO G Code system-A)
Optional block skip	2
Program stop / end	M00, M01 / M02, M30
Maximum command unit	± 999,999,999 mm, ± 99,999,9999 inch
Plane selection	X-Y : G17, X-Z : G18, Y-Z : G19
	G54 ~ G57, G505~G549
Workpiece coordinate system	G500 (Basic frame – settable zero offset)
	G53 (Work offset non modal)
	G153 (basic frame non modal)
Sub program call	11 folds nested
G code preventing buffering	STOPRE
Turning Cycle	Turning programming (Cycle 93, 94, 95, 97)
User Cycle	

Auxiliary function / Spindle speed function	
Auxiliary function	M Code 4 digit
Spindle speed function	S Code 5 digit
Spindle override	0% ~ 150% (10% Unit)
Spindle orientation	SPOS
Rigid tapping	
Automatic mode interchange	Spindle / Axis mode
Constant surface speed control	G96, G97
Spindle speed limitation	LIMS
Tool function / Tool compensation	
Tool function	Tool number & Tool name
Tool life management	Tool : T + Offset : D
Tools in tool list	128 ea : Std.
	256 ea : Mill
	768 ea : Y, MS, SY
Cutting Edges in tool list	256 ea : Std.
	512 ea : Mill
	1,536 ea : Y, MS, SY
Tool nose radius compensation	ISO (G40, G41, G42)
Geometry / Wear compensation	
Measurement of tool length	
Tool management function	
Editing function	
Part program storage size	3MB – Std.
	5MB – Mill
	10MB – Y, MS, SY
No. of registerable programs	750 ea
External Storage devices	Local network, Server, USB, Flash drive
Background editing	
Extended part program editing	Copy, move and change of NC program
Memory card program edit	
Data input / output & Interface	
I/O interface	CF card interface (ONLY 10.4") USB memory interface Embedded Ethernet memory interface
Screenshot	
Setting, display and diagnosis	
Self-diagnosis function	
History display & Operation	Alarm & Operator message & Operation
Run hour / Parts count display	
Maintenance information	
Actual cutting feedrate display	
Display of spindle speed / T code	
Graphic display	
Operating monitor screen	Spindle / Servo load etc. Support 9 languages Chinese (Simplified/Traditional), English, French, German, Italian, Korean, Portuguese, Spanish
Multi language display	[☆ Support 22 languages : Inquiry need]
LCD Screen Saver	Screen saver & Motion sensing
Function for machine type	
Cs contour control (C & A axes)	Mill, MS, Y, SY model
Polar coordinate interpolation	Mill, MS, Y, SY model
Cylindrical interpolation	Mill, MS, Y, SY model
Canned cycle for drilling	Mill, MS, Y, SY model
[Polygon turning (CP-Basic)]	Mill, MS, Y, SY model
[Hobbing / Skybing (CP-Comfort)]	Mill, MS, Y, SY model
Spindle synchronous control	MS, SY model
Servo tailstock function	MS, SY model
Option	
Additional optional block skip	10
Contour handwheel	
3D simulation	
Real time simulation	
Shop Turn	Machining step programming for turning



You Tube HYUNDAI WIA MT

www.youtube.com/HYUNDAIWIAMT

EXPERIENCE THE NEW TECHNOLOGY

With its top-quality HYUNDAI WIA machine tool creates a new and better world.



<http://machine.hyundai-wia.com>

HYUNDAI WIA Machine Tools
Global Links

HEADQUARTER

Changwon Technical Center/R&D Center/Factory 153, Jeongdong-ro, Seongsan-gu, Changwon-si, Gyeongsangnam-do, Korea TEL : +82 55 280 9114 FAX : +82 55 282 9114

Overseas Sales Team /R&D Center 37, Cheoldobangmulgwan-ro, Uiwang-si, Gyeonggi-do, Korea TEL : +82 31 8090 2539

OVERSEAS OFFICES

HYUNDAI WIA Machine America corp. 450 Commerce Blvd, Carlstadt, NJ 07072, USA TEL : +1-201-987-7298

HYUNDAI WIA Europe GmbH Alexander-Fleming-Ring 57, 65428 Rüsselsheim Germany TEL : +49-0-6142-9256-0

HYUNDAI WIA Machine Tools China 2-3F, Bldg6, No.1535 Hongmei Road, Xuhui District, Shanghai, China TEL : +86-21-6427-9885

India Branch Office #4/169, 1st Floor, LOTTE BLDG, Rajiv Gandhi Salai, (OMR), Kandanchavadi, Chennai - 600096, Tamilnadu, India TEL : +91-76-0490-3348

Vietnam Branch Office Flat number 05, Service and Trade Center of Viet Huong Industrial Zone, Highway 13, Thuan Giao, Thuan An, Binh Duong, Vietnam TEL : +84-3-5399-5099

2021-06 001.004 ENG