



 **AUSTRALIZ**
Capability Statement 2023



ENGINEERING PROJECTS STREAMLINED

“Unlock Success Through Purpose-Built Solutions.”

For the past 25 years, Australiz has been making it easier for clients to manage complex projects. Our experienced team provides a single point of contact for all suppliers, consultants, compliance and risk management, so you don't have to worry about the details.

The services provided include high-quality scan surveys, bespoke structural and mechanical design and access to specialised experts.

Let us handle the complexities of engineering projects while you focus on delivering exceptional results. Contact Australiz today to learn more about our consulting services.



SERVICES



PRELIMINARY
RELEASED

AN101195-PN50029 A

SERVICES - LASER SCANNING

Plant Equipment Laser Scanning

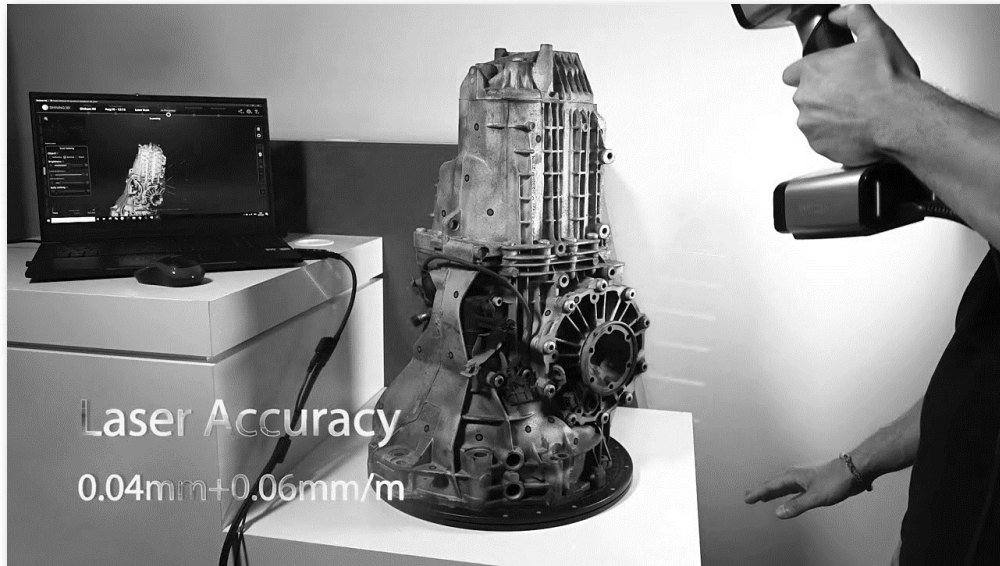

Terrestrial Colour Laser Scanning



SERVICES

3D Modelling & Scanning Integration

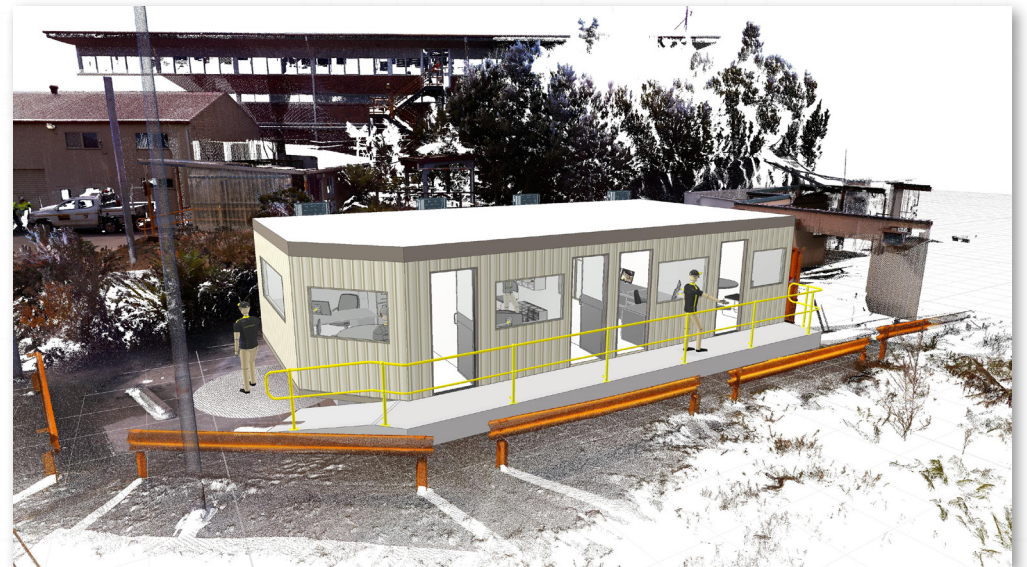
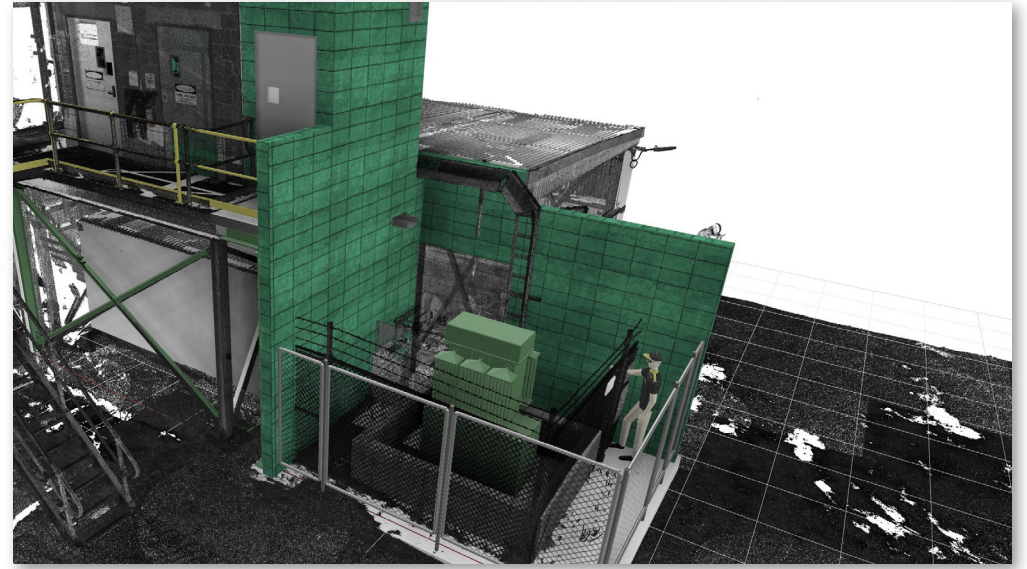
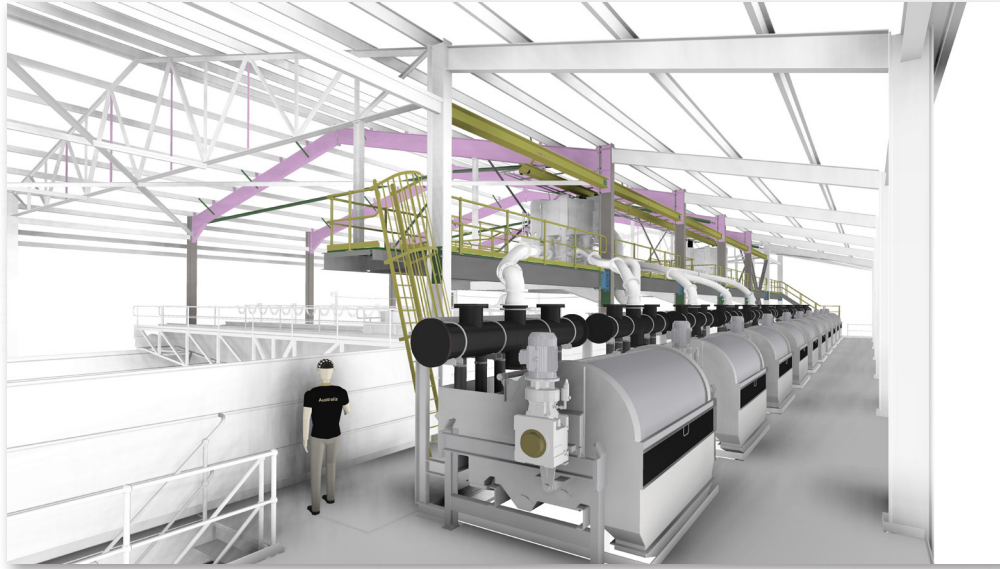

SERVICES

3D Modelling & Scanning Integration

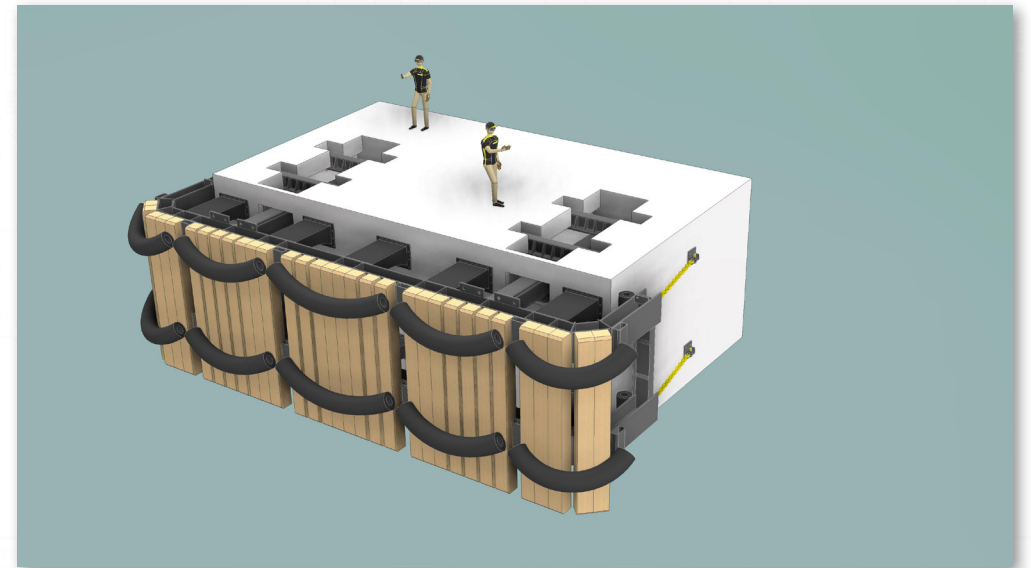
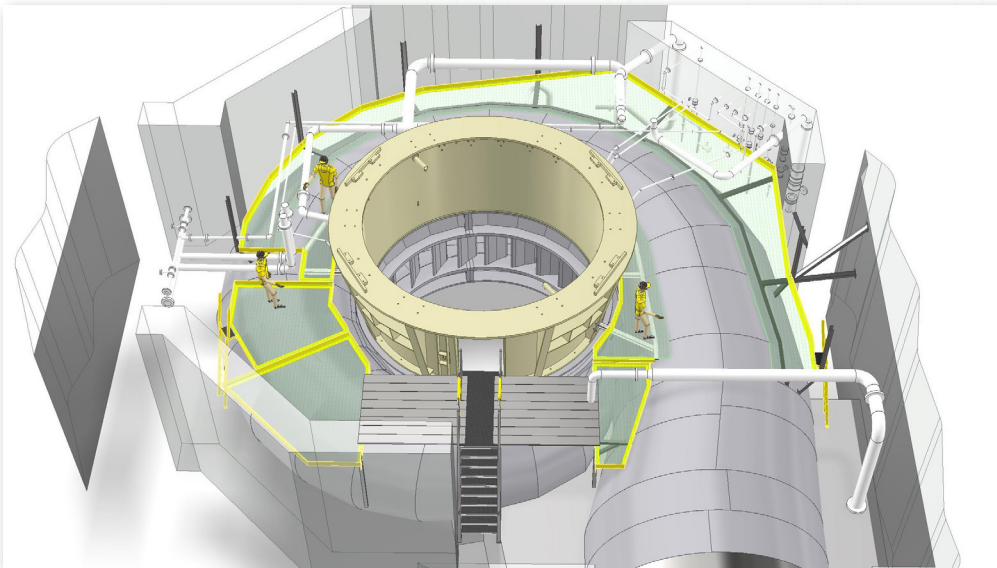
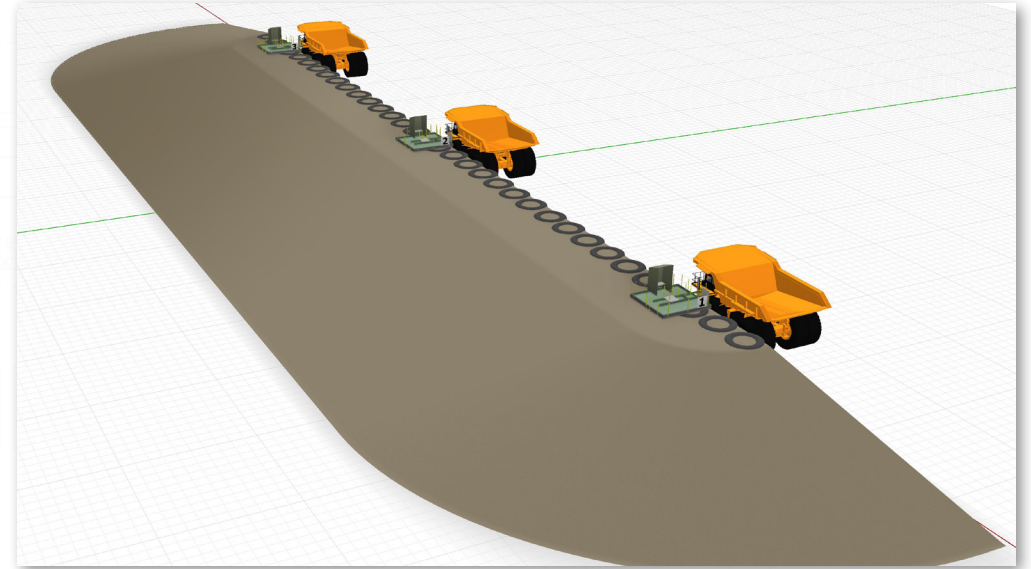
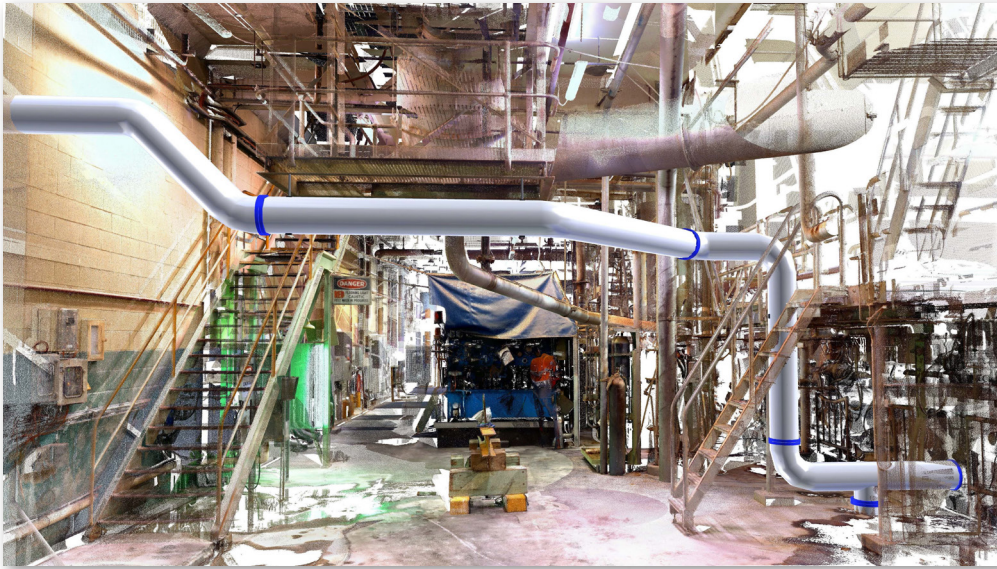

SERVICES

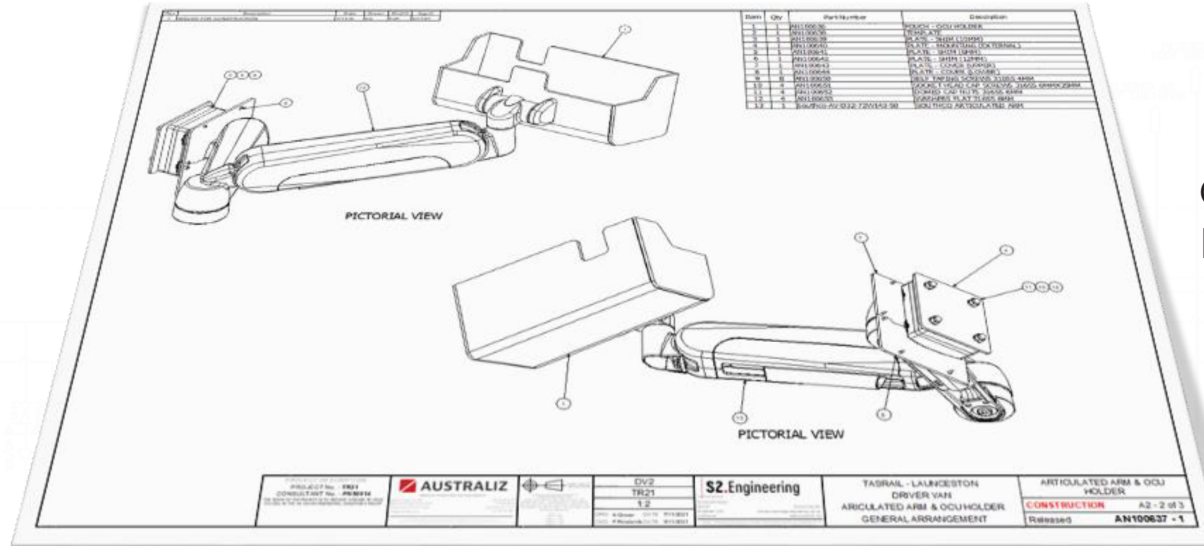

Quality Documentation

Process Design

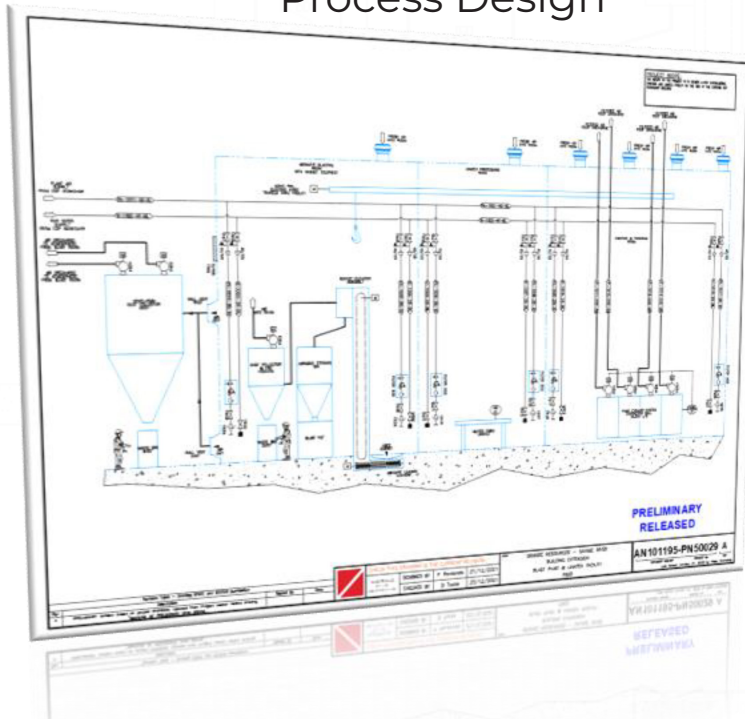

Mechanical

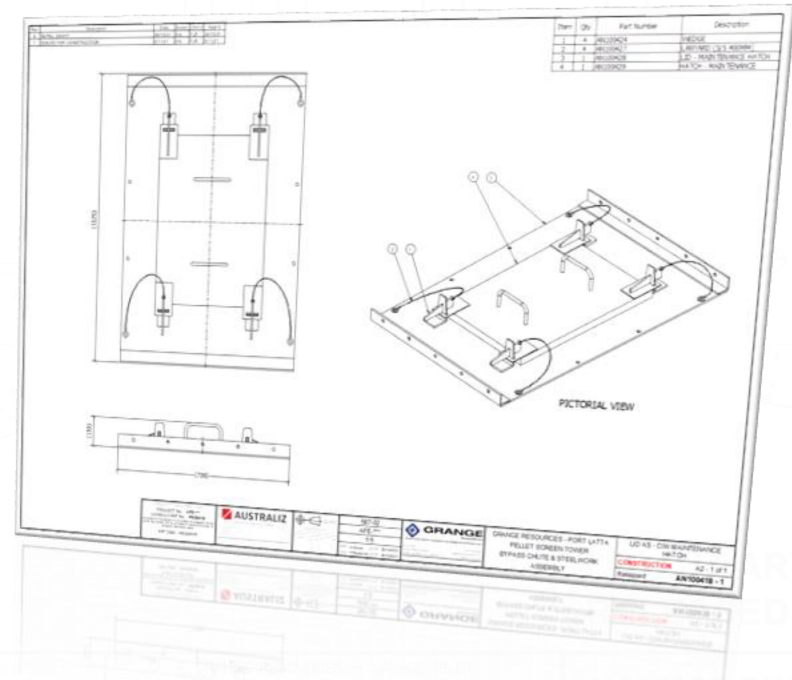

AN101195-PN50029 A

SERVICES

Safety

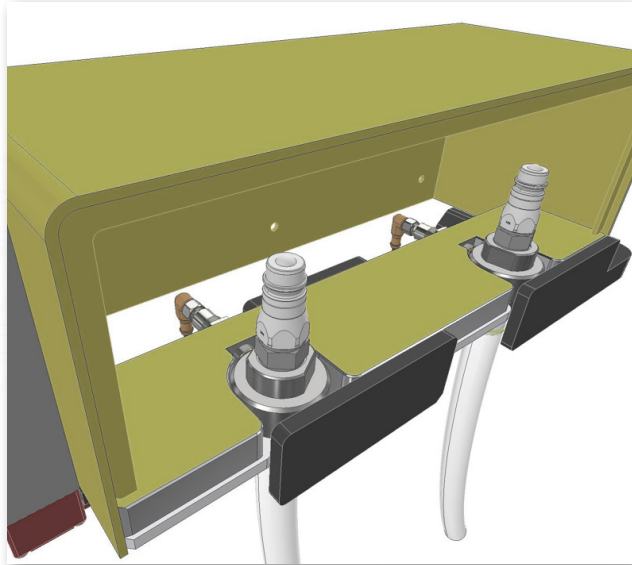

Vessels

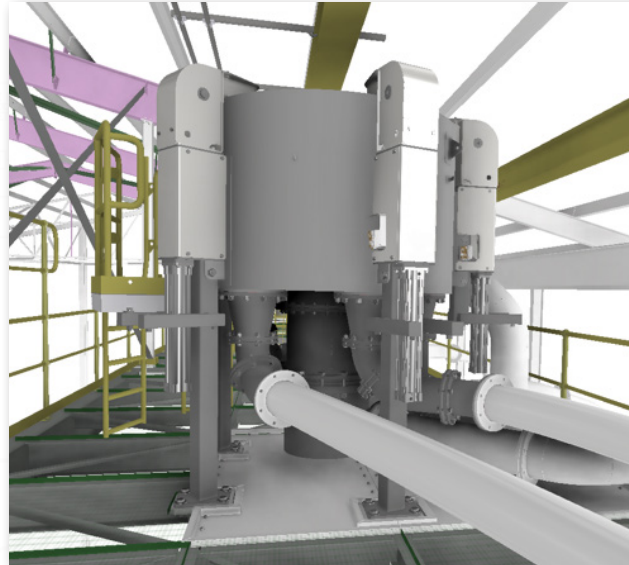

Ergonomics

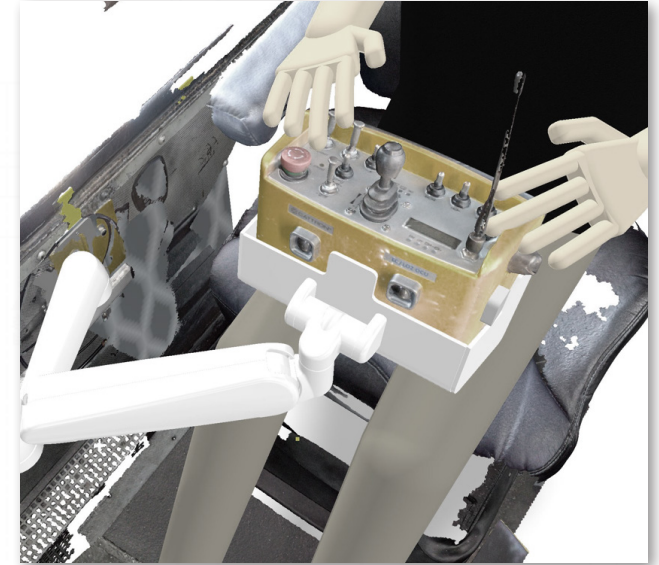

ARY
ED
PN50029 A



Capability Statement 2023