



SUMMIT[®] II

SERIES

1425W SWITCH MODE INDUSTRIAL BATTERY CHARGER

USER'S MANUAL

*Important Safety,
Installation,
Operation, and
Maintenance
Instructions*



CHARGER RATINGS LABEL

The ratings label is located on the front of the charger and provides the model (MODEL), serial number (located below the barcode at the bottom of the label), AC input ratings (INPUT), and DC output ratings (OUTPUT) of the charger. The BATTERY field indicates the factory-configured active battery profile type. The BATTERY field amp-hour (Ah) rating indicates the full range of battery capacities that are recommended for use with this charger. A different active battery profile may be required to optimize the charging of specific battery capacities within this range. Before (1) using the charger for the first time or (2) using the charger with a battery pack of a different type or capacity, use the ChargerConnect™ app to verify that the proper active battery profile is selected (see Section 8).

One of two styles of ratings label will be attached to your charger. Examples of both styles are shown below.

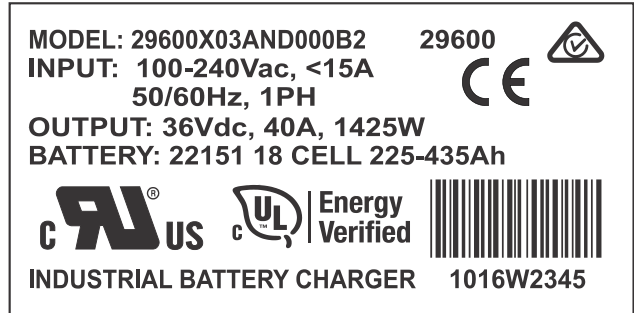

Please fill in the applicable blank label below with the information from the ratings label on your charger for future reference.

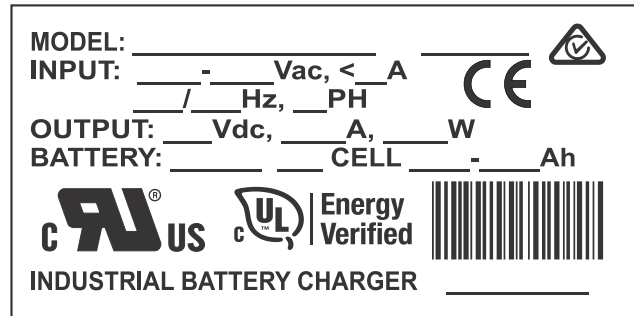
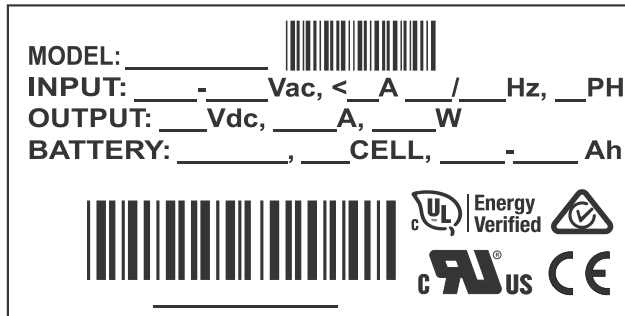

CAUTION: PRIOR TO OPERATING THE CHARGER, VERIFY THE BATTERY PROFILE MATCHES THE BATTERIES IN YOUR EQUIPMENT AND THE SYSTEM SETTINGS MATCH YOUR APPLICATION BY USING A WIRELESS DEVICE AND THE CHARGER APP AS DESCRIBED IN SECTION 10.4.

Document any configuration or settings changes that are made by marking the ratings label on your charger or on an additional label or tag attached to your charger.

SAVE THIS MANUAL: Keep it in a location where it is available to anyone who may operate the charger.

TABLE OF CONTENTS











CHARGER RATINGS LABEL	1
TABLE OF CONTENTS	3
IMPORTANT SAFETY INSTRUCTIONS	4
WICHTIGE SICHERHEITSANWEISUNGEN	6
IMPORTANTES CONSIGNES DE SÉCURITÉ	8
1. INTRODUCTION	10
2. RECEIVING AND INSTALLING THE CHARGER.....	10
3. BATTERY TYPE.....	12
4. OFF-BOARD (SHELF) VERSUS ON-BOARD (BUILT-IN) CHARGERS.....	13
4.1 Off-Board Chargers.....	13
4.2 On-Board Chargers.....	13
5. AC INPUT	13
6 DC OUTPUT	14
6.1 Auto Voltage Mode.....	14
6.2 DC Output Cordset.....	15
7 VEHICLE LOCKOUT CONTROL.....	17
8 BLUETOOTH® WIRELESS	17
9. EXTERNAL PORT.....	19
10. PROPER CARE OF DEEP-CYCLE LEAD-ACID MOTIVE POWER BATTERIES.....	19
10.1 Personal Safety Precautions.....	20
11. CHARGER OPERATION	20
11.1 Off-Board Charger Operation.....	21
11.2 On-Board Charger Operation.....	22
11.3 Storage Mode Operation.....	22
12. LED INDICATORS	23
12.1 Charger LED Status	23
12.2 Charger LED Faults.....	24
13. TROUBLESHOOTING	25
14. SPECIFICATIONS.....	25
15. SERVICE PART LIST.....	26

IMPORTANT SAFETY INSTRUCTIONS

1. **SAVE THESE INSTRUCTIONS** – This manual contains important safety and operating instructions.
2. Before using battery charger, read all instructions and cautionary markings on battery charger, battery, and product using battery.



LOOK FOR THIS SYMBOL TO POINT OUT SAFETY PRECAUTIONS. IT MEANS: *BE ALERT—YOUR SAFETY IS INVOLVED.* IF YOU DO NOT FOLLOW THESE SAFETY INSTRUCTIONS, INJURY OR PROPERTY DAMAGE CAN OCCUR.

3. ** DANGER:** TO REDUCE THE RISK OF FIRE OR ELECTRIC SHOCK, CAREFULLY READ AND FOLLOW THESE IMPORTANT SAFETY AND OPERATING INSTRUCTIONS BEFORE INSTALLING OR OPERATING THE CHARGER.
4. ** INSTRUCTIONS IMPORTANTES CONCERNANT LA SECURITÉ.**
5. ** WARNING:** TO REDUCE THE RISK OF FIRE, INSTALL THIS BATTERY CHARGER ON A SURFACE OF NON-COMBUSTIBLE MATERIAL SUCH AS BRICK, CONCRETE, OR METAL.
6. ** DANGER:** RISK OF ELECTRIC SHOCK. DISCONNECT CHARGER FROM BATTERY AND AC POWER BEFORE SERVICING. TURNING OFF THE CHARGER DOES NOT REDUCE THIS RISK.
7. ** DANGER:** RISK OF ELECTRIC SHOCK. DO NOT TOUCH UNINSULATED PORTION OF AC OR DC CONNECTORS OR UNINSULATED BATTERY TERMINAL.
8. ** DANGER:** RISQUE DE CHOCKS ÉLECTRIQUES. NE PAS TOUCHER LES PARTIES NON ISOLÉES DU CONNECTEUR DE SORTI OU LES BORNES NON ISOLÉES DE L'ACCUMULATEUR.
9. ** CAUTION:** CHARGE ONLY RECHARGEABLE BATTERIES OF THE SAME TYPE, VOLTAGE, CELL NUMBER, AND AMP-HOUR CAPACITIES AS SHOWN ON THE LABEL. BATTERY TYPES NOT MATCHING LABEL INFORMATION OR NON-RECHARGEABLE BATTERIES MAY BURST CAUSING PERSONAL INJURY AND DAMAGE.
10. ** ATTENTION:** UTILISER POUR CHARGER UNIQUEMENT LES ACCUMULATEURS AU PLOMB À ELECTROLYTE LIQUIDE. D'AUTRES TYPES D'ACCUMULATEURS POURRAIENT ÉCLATER ET CAUSER DES.
11. ** DANGER:** TO PREVENT ELECTRICAL SHOCK, DO NOT TOUCH EITHER AC OR DC UNINSULATED PARTS. MAKE SURE ALL ELECTRICAL CONNECTORS ARE IN GOOD WORKING CONDITION. DO NOT USE CONNECTORS THAT ARE CRACKED, CORRODED OR DO NOT MAKE ADEQUATE ELECTRICAL CONTACT. USE OF A DAMAGED OR DEFECTIVE CONNECTOR MAY RESULT IN A RISK OF OVERHEATING OR ELECTRIC SHOCK.
12. ** WARNING:** HAZARD OF ELECTRIC SHOCK.

-
13. **⚠ WARNING: LEAD-ACID BATTERIES GENERATE EXPLOSIVE GASES. PLACE BATTERIES AS FAR AWAY FROM THE CHARGER AS THE OUTPUT LEADS WILL PERMIT DURING CHARGING. TO PREVENT ARCING OR BURNING NEAR BATTERIES, DO NOT DISCONNECT DC CHARGING CORD FROM BATTERIES WHEN THE CHARGER IS OPERATING. KEEP SPARKS, FLAME, AND SMOKING MATERIALS AWAY FROM BATTERIES.**
 14. **⚠ WARNING: ALWAYS SHIELD EYES WHEN WORKING NEAR BATTERIES. DO NOT PUT WRENCHES OR OTHER METAL OBJECTS ACROSS BATTERY TERMINAL OR BATTERY TOP. ARCING OR EXPLOSION OF THE BATTERY CAN RESULT.**
 15. **⚠ WARNING: BATTERIES PRODUCE HYDROGEN GAS, WHICH CAN EXPLODE IF IGNITED. NEVER SMOKE, USE AN OPEN FLAME, OR CREATE SPARKS NEAR THE BATTERY. VENTILATE THE AREA WHEN THE BATTERY IS CHARGING IN AN ENCLOSED PLACE.**
 16. **⚠ WARNING: LEAD-ACID BATTERIES CONTAIN SULFURIC ACID, WHICH MAY CAUSE BURNS. DO NOT GET ACID IN EYES, ON SKIN, OR CLOTHING. IF CONTACT WITH THE EYES OCCURS, FLUSH IMMEDIATELY WITH CLEAN WATER FOR 15 MINUTES AND OBTAIN MEDICAL ATTENTION.**
 17. **⚠ WARNING: ONLY A QUALIFIED SERVICE TECHNICIAN SHOULD PROGRAM OR SERVICE THIS EQUIPMENT.**
 18. **⚠ CAUTION: DO NOT OPERATE THE CHARGER IF IT HAS RECEIVED A SHARP BLOW, BEEN DROPPED, OR OTHERWISE DAMAGED. HAVE A QUALIFIED SERVICE TECHNICIAN EXAMINE AND REPAIR AS NEEDED.**
 19. **⚠ WARNING: DO NOT DISASSEMBLE THE CHARGER. HAVE THE CHARGER EXAMINED BY A QUALIFIED SERVICE TECHNICIAN. INCORRECT RE-ASSEMBLY OF THE CHARGER MAY RESULT IN AN EXPLOSION, ELECTRIC SHOCK, OR FIRE.**
 20. **⚠ CAUTION: MAKE SURE THE BATTERY SYSTEM HAS THE PROPERLY RATED VOLTAGE, AMP-HOURS, AND TYPE (“WET”, “AGM”, “GEL”, ETC.) FOR THIS CHARGING SYSTEM.**







SAVE THESE INSTRUCTIONS

WICHTIGE SICHERHEITSANWEISUNGEN

1. BEWAHREN SIE DIESE ANWEISUNGEN AUF. - Dieses Handbuch enthält wichtige Sicherheits- und Betriebsanweisungen.
2. Bevor Sie das Ladegerät verwenden, lesen Sie alle Anweisungen und Warnhinweise auf dem Ladegerät, der Batterie und dem Produkt, das die Batterie verwendet.



ACHTEN SIE AUF DIESES SYMBOL, UM DIE SICHERHEITSVORKEHRUNGEN ZU ERKENNEN. DAS BEDEUTET: ACHTUNG—DAS BETRIFFT IHRE SICHERHEIT. WENN SIE DIESE SICHERHEITSHINWEISE NICHT BEFOLGEN, KÖNNEN VERLETZUNGEN ODER SACHSCHÄDEN VERURSACHT WERDEN.

3.  **GEFAHR:** UM DIE GEFAHR EINES BRANDES ODER EINES ELEKTRISCHEN SCHLAGS ZU REDUZIEREN, LESEN SIE DIESE WICHTIGEN SICHERHEITS- UND BEDIENUNGSANLEITUNGEN SORGFÄLTIG DURCH, BEVOR SIE DAS LADEGERÄT INSTALLIEREN ODER BETREIBEN.
5.  **WARNUNG:** UM FEUERGEFAHR ZU VERRINGERN, INSTALLIEREN SIE DIESES BATTERIELADEGERÄT AUF EINER OBERFLÄCHE AUS NICHT BRENNBAREM MATERIAL, WIE ZIEGELN, BETON ODER METALL.
6.  **GEFAHR:** STROMSCHLAGGEFAHR. TRENNEN SIE DAS LADEGERÄT VOR DER WARTUNG VON DER BATTERIE UND NETZSTROM. DAS AUSSCHALTEN DES LADEGERÄTS VERRINGERT DIESES RISIKO NICHT.
7.  **GEFAHR:** STROMSCHLAGGEFAHR. BERÜHREN SIE NICHT DEN UNINSULIERTEN TEIL VON AC- ODER DC-ANSCHLÜSSEN ODER UNINSULIERTEN BATTERIEANSCHLUSS.
9.  **ACHTUNG:** NUR AKKUS DER GLEICHEN ART, SPANNUNG, ZELLENZAHL UND AMPERESTUNDEN-KAPAZITÄT WIE AUF DEM ETIKETT AUFLADEN. BATTERIEARTEN, DIE NICHT DER ETIKETTENINFORMATION ENTSPRECHEN, ODER NICHT-WIEDERAUFLADBARE BATTERIEN KÖNNEN PLATZEN UND KÖRPERVERLETZUNG UND SCHADEN VERURSACHEN.
11.  **GEFAHR:** UM EINEN ELEKTRISCHEN SCHLAG ZU VERMEIDEN, BERÜHREN SIE NIEMALS UNINSULIERTE AC-OBER ODER DC-TEILE. VERWENDEN SIE KEINE ANSCHLUSSSTECKER DIE RISSIG ODER KORRIGIERT SIND, ODER DIE SICH NICHT KORREKT ANSTECKEN LASSEN. DIE VERWENDUNG EINES BESCHÄDIGTEN ODER FEHLERHAFTEN STECKVERBINDERS KANN ZU ÜBERHITZUNGS- ODER STROMSCHLAGGEFAHR FÜHREN.
12.  **WARNUNG:** STROMSCHLAGGEFAHR.

-
13. **⚠️ WARNUNG:** BLEIAKKUS ERZEUGEN EXPLOSIVE GASE. BATTERIEN WÄHREND DES LADEVORGANGS SO WEIT WIE MITTELS DER LEITUNGEN MÖGLICH VOM LADEGERÄT ENTFERNT PLATZIEREN. UM EINE FUNKENBILDUNG ODER EINEN BRAND IN DER NÄHE DER BATTERIEN ZU VERMEIDEN, DAS DC-LADEKABEL NICHT VON DEN BATTERIEN ENTFERNEN, WENN DAS LADEGERÄT IN BETRIEB IST. FUNKEN, FLAMMEN UND RAUCHENDE MATERIALIEN VON DEN BATTERIEN ENTFERNT AUFBEWAHREN.
 14. **⚠️ WARNUNG:** SCHÜTZEN SIE IMMER DIE AUGEN, WENN SIE MIT BATTERIEN ARBEITEN. KEINE SCHLÜSSELANHÄNGER ODER ANDERE METALLGEGENSTÄNDE ÜBER DEN BATTERIEANSCHLUSS ODER DIE BATTERIEPLATTE LEGEN. BOGEN ODER EXPLOSION DER BATTERIE KÖNNEN GESCHEHEN.
 15. **⚠️ WARNUNG:** BATTERIEN ERZEUGEN WASSERSTOFFGAS, DAS EXPLODIEREN KANN, WENN ES ENTZÜNDET WIRD. RAUCHEN SIE NIEMALS, VERWENDEN SIE NIE EINE OFFENE FLAMME ODER ERZEUGEN SIE NIEMALS FUNDEN IN DER NÄHE DER BATTERIE. BELÜFTEN SIE DEN GEGEND, WENN DIE BATTERIE IN EINEM GESCHLOSSENEN ORT AUFGELADEN WIRD.
 16. **⚠️ WARNUNG:** BLEI SÄURE-BATTERIEN ENTHALTEN SCHWEFELSÄURE, WELCHE VERBRENNUNGEN VERURSACHEN KANN. VERMEIDEN SIE KONTAKT MIT DEN AUGEN, DER HAUT ODER DER KLEIDUNG MIT DER SÄURE. FALLS ES KONTAKT MIT DEN AUGEN GEBEN SOLLTE, SPÜLEN SIE DEN AUGEN SOFORT 15 MINUTEN LANG MIT REINEM WASSER UND SUCHEN SIE EINEN ARZT AUF.
 17. **⚠️ WARNUNG:** NUR EIN QUALIFIZIERTER SERVICE-TECHNIKER SOLLTE DIESES GERÄT PROGRAMMIEREN ODER SERVISIEREN.
 18. **⚠️ ACHTUNG** BETREIBEN SIE DAS LADEGERÄT NICHT, WENN ES EINEN SCHWEREN SCHLAG ERHALTEN HAT, FALLEN GELASSEN WURDE ODER ANDERWEITIG BESCHÄDIGT WURDE. BITTEN SIE EINEN QUALIFIZIERTEN WARTUNGSTECHNIKER ES ZU ÜBERPRÜFEN UND ZU REPARIEREN, FALLS ERFORDERLICH.
 19. **⚠️ WARNUNG:** DEMONTIEREN SIE DAS LADEGERÄT NICHT. BITTEN SIE EINEN QUALIFIZIERTEN SERVICE-TECHNIKER DAS LADEGERÄT ZU ÜBERPRÜFEN. FALSCHER WIEDERZUSAMMENBAU DES LADEGERÄTES KANN ZU EXPLOSION, ELEKTROSCHOCK ODER FEUER FÜHREN.
 20. **⚠️ ACHTUNG** VERGEWISSERN SIE SICH, DASS DAS BATTERIESYSTEM FÜR DIESES LADESYSYSTEM DIE RICHTIG ANGEGEBENE SPANNUNG, AMP-STUNDEN UND TYP ("NASS", "AGM", "GEL", ETC.) HAT.







ANLEITUNG AUFBEWAHREN.

IMPORTANTES CONSIGNES DE SÉCURITÉ

1. **GARDEZ CES CONSIGNES –** Ce manuel contient d'importantes consignes de sécurité et le mode d'emploi.
2. **Avant l'emploi de ce chargeur de batterie, lisez toutes les consignes et marques d'avertissement sur le chargeur de batterie, la batterie, et le produit utilisant cette batterie.**



CHERCHEZ CE SYMBOLE POUR INDIQUER LES PRÉCAUTIONS DE SÉCURITÉ. CELA SIGNIFIE: SOYEZ VIGILANT—VOTRE SÉCURITÉ EN DÉPEND. LE FAIT DE NE PAS SUIVRE CES CONSIGNES DE SÉCURITÉ PEUT CAUSER DES BLESSURES ET ENDOMMAGER LA PROPRIÉTÉ.

3. ** DANGER: POUR RÉDUIRE LE RISQUE D'INCENDIE OU DE DÉCHARGE ÉLECTRIQUE, LISEZ ATTENTIVEMENT ET SUIVEZ CES CONSIGNES DE SÉCURITÉ, ET MODE D'EMPLOI AVANT L'INSTALLATION OU L'USAGE DU CHARGEUR.**
5. ** AVERTISSEMENT: POUR RÉDUIRE LE RISQUE D'INCENDIE, INSTALLEZ CE CHARGEUR DE BATTERIE SUR UNE SURFACE EN MATÉRIEL NON-COMBUSTIBLE COMME BRIQUE, BÉTON OU MÉTAL.**
6. ** DANGER: RISQUE DE DÉCHARGE ÉLECTRIQUE. DÉBRANCHEZ LE CHARGEUR DE LA BATTERIE ET DU COURANT ALTERNATIF AVANT L'ENTRETIEN. L'ARRÊT DU CHARGEUR NE RÉDUISANT POINT CE RISQUE.**
7. ** DANGER: RISQUE DE DÉCHARGE ÉLECTRIQUE. NE TOUCHEZ PAS LES PARTIES NON-ISOLÉES DES CONNECTEURS AC OU DC, OU LE BORNE NON-ISOLÉ DE LA BATTERIE.**
9. ** PRÉCAUTION: RECHARGER UNIQUEMENT LES BATTERIES RECHARGEABLES DU MÊME TYPE, DE LA MÊME TENSION, QUI ONT LE MÊME NUMÉRO DE CELLULES ET LA MÊME CAPACITÉ EN AMPÈRES-HEURES QUE LA VALEUR AFFICHÉE SUR L'ÉTIQUETTE. LES TYPES DE BATTERIES QUI NE CORRESPONDENT PAS AUX DONNÉES SUR L'ÉTIQUETTE OU LES BATTERIES NON-RECHARGEABLES PEUVENT EXPLOSER ET PROVOQUER DES BLESSURES OU DES DOMMAGES.**
11. ** DANGER: POUR ÉVITER LES DÉCHARGES ÉLECTRIQUES, NE TOUCHEZ PAS LES PARTIES NON-ISOLÉES, NI AC NI DC. ASSUREZ-VOUS QUE TOUS LES CONNECTEURS ÉLECTRIQUES SONT EN BON ÉTAT DE FONCTIONNEMENT. N'UTILISEZ PAS LES CONNECTEURS QUI SONT CRAQUELÉS, CORRODÉS NI NE FAITES CONTACT ÉLECTRIQUE ADÉQUAT. L'EMPLOI D'UN CONNECTEUR ENDOMMAGÉ OU DÉFECTUEUX PEUT PROVOQUER UN RISQUE DE SURCHAUFFE OU DE DÉCHARGE ÉLECTRIQUE.**
12. ** AVERTISSEMENT: DANGER DE DÉCHARGE ÉLECTRIQUE.**

-
13. **⚠ AVERTISSEMENT:** LES PILES PLOMB-ACIDE GENERENT DES GAZ EXPLOSIFS. PENDANT LE CHARGEMENT, PLACER LES PILES AUSSI LOIN DU CHARGEUR QUE LES FILS DE SORTIE LE PERMETTENT. POUR EVITER TOUT ARC ELECTRIQUE OU TOUTE BRULURE A PROXIMITE DES PILES, NE PAS DEBRANCHER LE CORDON DE RECHARGE CC DES PILES LORSQUE LE CHARGEUR EST EN FONCTION. GARDER LES ETINCELLES, LES FLAMMES ET LES SUBSTANCES FUMIGENES A DISTANCE DES PILES.
 14. **⚠ AVERTISSEMENT:**N'oubliez jamais de protéger vos yeux lorsque vous travaillez près des batteries. Ne posez jamais les clés ou autres objets métalliques à travers les bornes de la batterie ou dessus la batterie. Car cela peut causer un arc électrique ou une explosion de la batterie.
 15. **⚠ AVERTISSEMENT:** LES BATTERIES PRODUISENT DE L'HYDROGÈNE, QUI PEUT EXPLOSER SI MISE À FEU. NE FUMEZ JAMAIS, NI N'UTILISEZ UNE FLAMME, NI NE CRÉEZ DES ÉTINCELLES PRÈS DE LA BATTERIE. AÉREZ LA PLACE QUAND LA BATTERIE EST EN TRAIN DE CHARGER DANS UN ENDROIT FERMÉ.
 16. **⚠ AVERTISSEMENT:** LES BATTERIES PLOMB-ACIDE CONTIENNENT DE L'ACIDE SULFURIQUE, QUI PEUT CAUSER DES BRÛLURES. N'ATTRAPEZ PAS L' ACIDE DANS LES YEUX, NI SUR LA PEAU, NI SUR LES VÊTEMENTS. EN CAS DE CONTACT AVEC LES YEUX, RINCEZ IMMÉDIATEMENT AVEC DE L'EAU PROPRE PENDANT 15 MINUTES PUIS ACCEDER AUXSOINS MÉDICAUX.
 17. **⚠ AVERTISSEMENT:** SEUL UN TECHNICIEN DE SERVICE QUALIFIÉ POURRAIT PROGRAMMER OU RÉVISER CET ÉQUIPEMENT.
 18. **⚠ ATTENTION:** NE FAITES PAS MARCHER LE CHARGEUR S'IL A SUBI UN COUP VIOLENT, EST TOMBÉ, OU AUTREMENT ENDOMMAGÉ. FAITES-LE VOIR PAR UN TECHNICIEN DE SERVICE QUALIFIÉ, ET LE FAIRE RÉPARER SI BESOIN EST
 19. **⚠ AVERTISSEMENT:** NE DÉMONTÉZ PAS LE CHARGEUR. FAITES-LE VOIR PAR UN TECHNICIEN DE SERVICE QUALIFIÉ. LE RASSEMBLAGE INCORRECT DU CHARGEUR PEUT RÉSULTER EN EXPLOSION, DÉCHARGE ÉLECTRIQUE, OU INCENDIE.
 20. **⚠ ATTENTION:** ASSUREZ-VOUS QUE LE SYSTÈME DE BATTERIE A LA CORRECTE TENSION NOMINALE, L'AMP-HEURE, ET LE TYPE ("HUMIDE", "AGM", "GEL", ETC.) POUR CE SYSTÈME DE BATTERIE.

GARDEZ CÉ CONSIGNES

1. INTRODUCTION

This switch mode (high frequency) industrial battery charger features advanced charge and termination algorithms designed to optimize both daily battery capacity and overall battery life. The charger is convection cooled with no moving parts, sealed, and designed to provide maximum reliability. The universal AC input enables the charger to be used with a wide range of AC voltages and frequencies, and the charger includes high efficiency and power factor correction. Interface features of the charger include four (4) LEDs. The 1425W charger models are also capable of automatic multi-voltage DC charging, which enables automatic DC output voltage detection and adjustment based on the battery pack connected to it.

The charger features Bluetooth® wireless communication, which enables a smart phone or tablet running the ChargerConnect™ app to be used to:

- View the real-time charge cycle status
- Download charge cycle history records from the charger
- Upload charge cycle history records to the Cloud for access anywhere in the world
- Select the active battery profile
- Download new battery profiles from the Cloud
- Upload battery profiles to the charger

The charger was factory-configured with the active battery profile that was requested as part of the original order from Lester Electrical. The charger was also factory-configured for mounting on-board a battery-powered vehicle/machine or for off-board use in a shelf or portable application per the original order from Lester Electrical. Before (1) using the charger for the first time or (2) using the charger with a battery pack of a different type or capacity, use the ChargerConnect app to verify that the proper active battery profile is selected and that the system settings match your application (see Section 8).

 CAUTION: PRIOR TO OPERATING THE CHARGER, VERIFY THAT THE ACTIVE BATTERY PROFILE MATCHES THE BATTERIES IN YOUR EQUIPMENT AND THAT THE SYSTEM SETTINGS MATCH YOUR APPLICATION BY USING A SMART PHONE OR TABLET AND THE CHARGERCONNECT APP AS DESCRIBED IN SECTION 8.

This appliance is not intended for use by persons (including children) with reduced physical, sensory or mental capabilities, or lack of experience and knowledge, unless they have been given supervision or instruction concerning use of the appliance by a person responsible for their safety. Children should be supervised to ensure that they do not play with the appliance.

2. RECEIVING AND INSTALLING THE CHARGER

Unpack the charger and examine it for shipping damage. In the event that shipping damage is found, report it as a claim with the freight company.

 WARNING: REPLACE WORN, DAMAGED, OR CUT ELECTRICAL CORDS AND PLUGS IMMEDIATELY.

Do not operate the charger with a damaged AC or DC cable or connector. Do not operate the charger if it has received a sharp blow, was dropped, or was otherwise damaged in any way. Contact your dealer.

 WARNING: DO NOT INSTALL THE CHARGER ON OR NEAR FLAMMABLE MATERIALS. POSITION THE CHARGER ON A FOUNDATION OF STONE, BRICK, CONCRETE OR GROUNDED METAL.

 WARNING: CHARGERS CAN IGNITE FLAMMABLE MATERIALS AND VAPORS. DO NOT USE NEAR FUELS, GRAIN DUST, SOLVENTS, THINNERS, OR OTHER FLAMMABLES.

Proper installation is important to achieve optimum performance and life from the charger and batteries. No minimum distances are specified for mounting clearances, but allow as much free air space around the charger as possible to improve performance. Please refer to the Specifications Section 14 for operating environmental specifications.

The most favorable mounting orientations of the charger are shown in Figure 2-1. For on-board use, the most favorable way to mount the charger is with the charger base bolted to a 0.1 inch (2.5 mm) minimum thick metal plate. This provides both a strong structural mounting and good thermal conductive cooling (examples are shown in Figure 2-1). A poor thermal conductive mounting material such as plastic or wood would be less favorable for cooling.

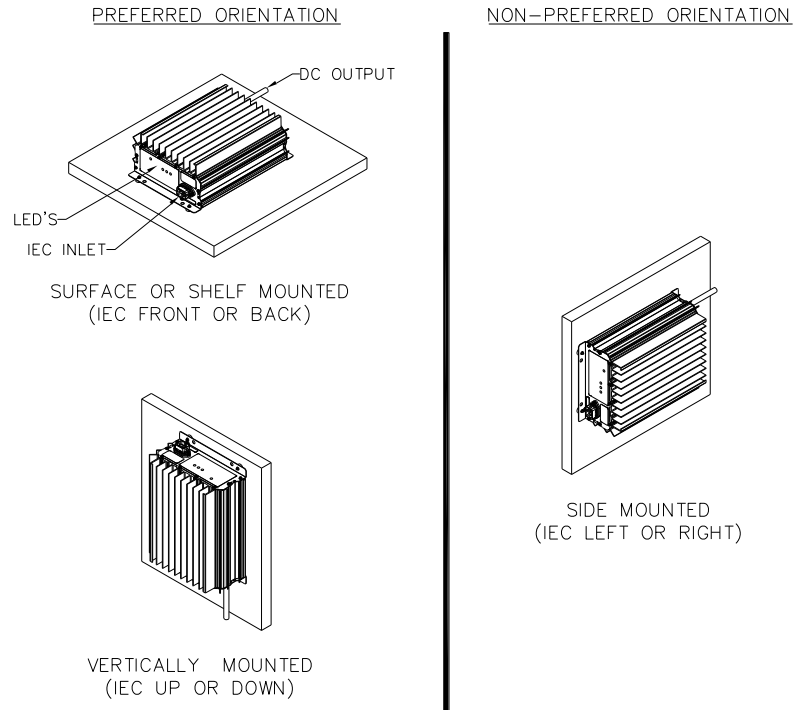

Figure 2-1: Charger Mounting Recommendations

The charger dimensions and mounting hole locations are shown in Figure 2-2. For off-board use, an optional handle is available for ease in carrying. The charger case also has routing and securing locations for the AC and DC cordsets when they need to be routed to the opposite ends as shown in Figure 2-3.

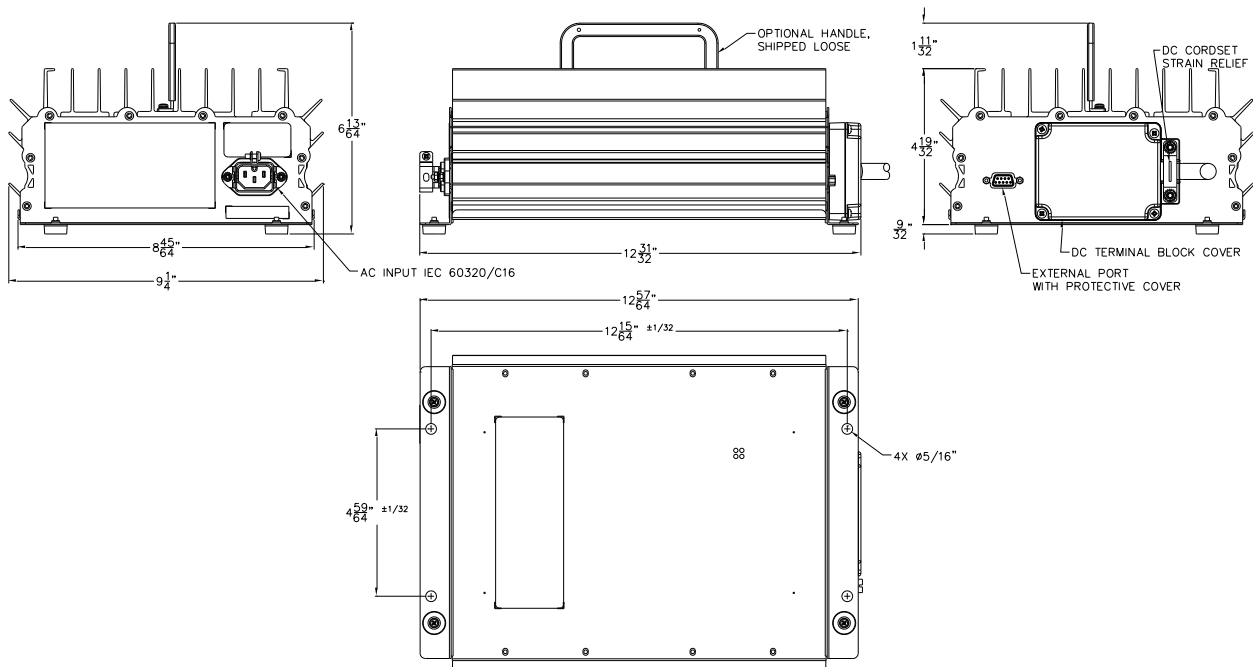

Figure 2-2: Charger Dimensions and Mounting Hole Locations

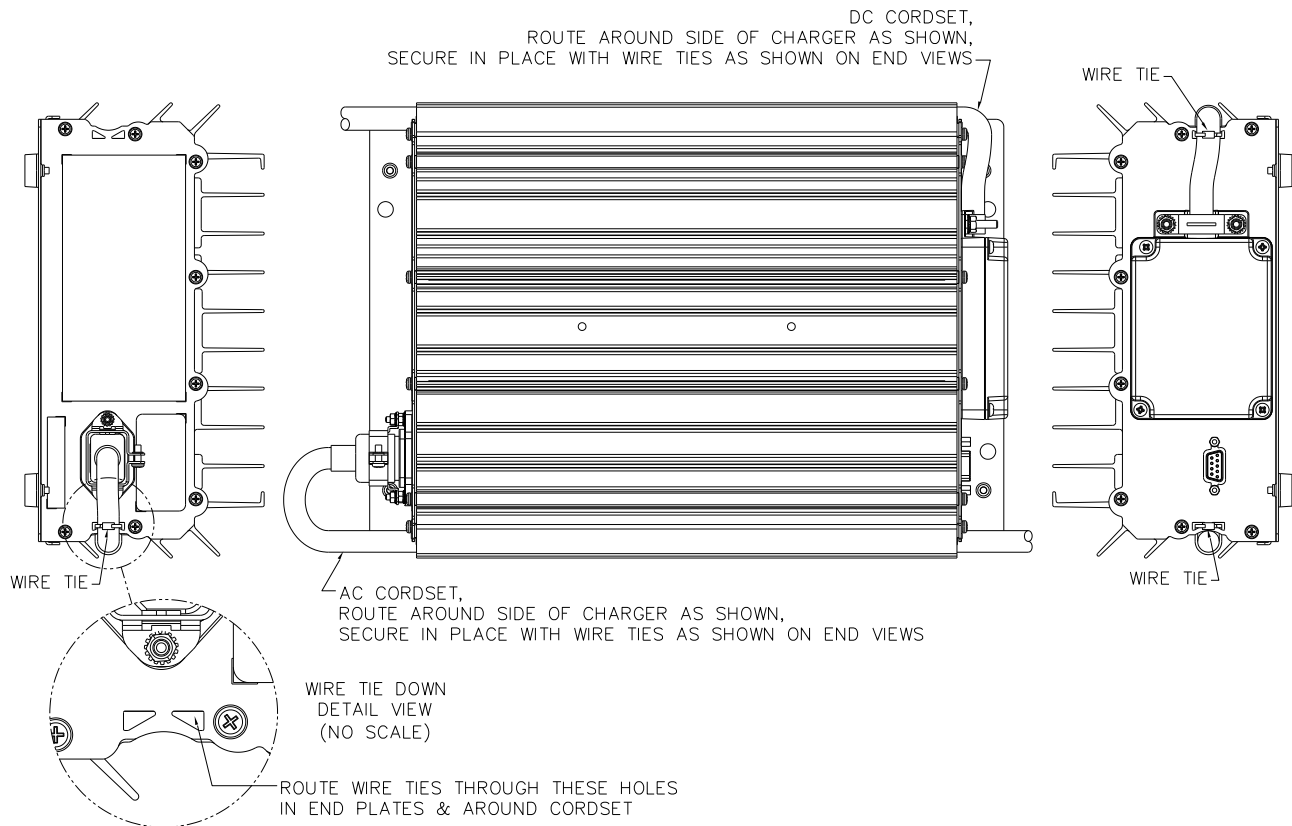

Figure 2-3: AC & DC Cordset Routing

3. BATTERY TYPE

This charger contains multiple battery profiles for different battery types (including wet/flooded, AGM, and gel) and capacities of batteries. The charger was factory-configured with the active battery profile that was requested as part of the original order from Lester Electrical. Before (1) using the charger for the first time or (2) using the charger with a battery pack of a different type or capacity, use the ChargerConnect app to verify the proper active battery profile is selected. If the proper battery profile is not available on the charger, the ChargerConnect app can be used to download the appropriate battery profile from the Cloud. If the battery type you will be charging is not available via the ChargerConnect app Cloud (for example, a specific lithium-ion brand or chemistry), contact Lester Electrical for more information. See Section 8 for additional details.

If the active battery profile is changed, mark the charger ratings label or add an additional label or tag.

⚠ CAUTION: THIS CHARGER IS FOR USE ONLY WITH BATTERY SYSTEMS OF THE SAME TYPE AS THE ACTIVE BATTERY PROFILE. BATTERIES IMPROPERLY MATCHED WITH THE CHARGER MAY BURST CAUSING PERSONAL INJURY AND DAMAGE TO THE BATTERIES OR CHARGER.

Battery manufacturers frequently use the same battery cases for different battery types. Wet/flooded batteries have removable cell caps. Water electrolyzed by discharging and charging the battery is replaced through these openings. Sealed batteries are generally distinguished by non-removable cell caps. The physical appearance of the battery case is frequently the same as a wet battery, though the cell caps are generally not removable. Refer to the battery manufacturer's information panel on the battery case to determine the type battery you have. If the information panel is missing or not legible, do not use the battery.

If you have questions regarding which battery profile to select for use with your particular battery pack, contact your dealer for assistance.

4. OFF-BOARD (SHELF) VERSUS ON-BOARD (BUILT-IN) CHARGERS

This section describes how the charger operates when the charger type is set to Off-board or On-board. Based on your application, this setting can be changed via the ChargerConnect app under “System Profile” (see Section 8).

The charger was factory-configured with the active battery profile that was requested as part of the original order from Lester Electrical. The charger was also factory-configured for mounting on-board a battery-powered vehicle/machine or for off-board use in a shelf or portable application per the original order from Lester Electrical. Before (1) using the charger for the first time or (2) using the charger with a battery pack of a different type or capacity, use the ChargerConnect app to verify that the proper active battery profile is selected and that the system settings match your application (see Section 8).

4.1 Off-Board Chargers

Off-board chargers are designed to be used in shelf or portable applications. If the AC input plug is connected to AC power, a new charge cycle automatically starts when the DC output is connected to a battery pack of the proper voltage. Disconnecting and reconnecting AC power while the DC output remains connected to a battery pack WILL NOT automatically start a new charge cycle. Disconnecting the DC output from the battery pack IS REQUIRED to automatically start a new charge cycle.

4.2 On-Board Chargers

On-board chargers are designed to be mounted on electric vehicles/equipment. If the DC output is connected to a battery pack of the proper voltage, a charge cycle automatically starts when the AC input plug is connected to AC power (unless a safety period of time has not passed since the successful completion of the previous charge cycle). Disconnecting the DC output from the battery pack IS NOT REQUIRED to automatically start a new charge cycle.

5. AC INPUT

⚠ CAUTION: TO REDUCE THE RISK OF ELECTRIC SHOCK OR FIRE, DISCONNECT AC POWER FROM THE CHARGER BEFORE INSTALLING OR REMOVING UNIT.

The charger has an AC input rating of 100-240 volts, 50-60 hertz, single-phase. The charger has an AC operating range of 85-265 volts, 45-65 hertz. Below 108 volts, the charger may reduce output power.

The charger is equipped with an IEC 60320 C16 inlet for the AC input power as shown. This allows the AC power cordset to be selected with a proper plug compatible with local electrical codes. The AC power cordset wiring must be properly sized for safe operation. For 100-120Vac operation use a minimum of 14 AWG (2.0 mm²) and for 220-240Vac operation use a minimum wire size of 18 AWG (1.0 mm²). An AC cord clamp is also included to retain the AC power cordset IEC 60320 C15 connector when the connector has the dimensions as shown below. Loosen the screw on the clamp before inserting the C15 connector. Fully insert the connector into the charger inlet and then tighten the AC cord clamp screw to secure the AC power cordset to the charger.

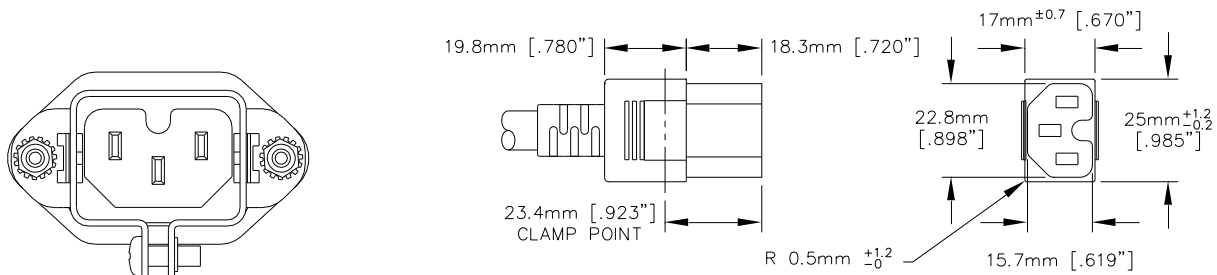

⚠ CAUTION: IF THE IEC 60320 C15 CONNECTOR DIMENSIONS ARE LARGER THAN SHOWN ABOVE, VERIFY CONNECTOR IS PUSHED ALL THE WAY INTO THE CHARGER INLET OR RISK OF FIRE DUE TO LOOSE CONNECTION MAY OCCUR.

The charger must be grounded to reduce the risk of electric shock and is equipped with an IEC 60320 C16 inlet having an equipment-grounding conductor and a grounding socket. The installed AC power cordset must be plugged into an outlet that is properly installed and grounded in accordance with all applicable electrical codes and ordinances.

If this charger includes the UL Listed symbol on its ratings label, it is provided with a cord set for connection to outlets operating at nominal 120 volts (or 240 volts as appropriate). If the input plug does not fit the power outlet, contact Lester Electrical for the proper cord set terminating in an attachment plug of the proper configuration for the power outlet.

⚠ DANGER: NEVER ALTER THE AC POWER CORDSET OR PLUG PROVIDED. IF IT WILL NOT FIT AN OUTLET, OBTAIN THE CORRECT CHARGER IEC AC POWER CORDSET FOR THE OUTLET, OR HAVE A PROPER OUTLET INSTALLED BY A QUALIFIED ELECTRICIAN. IMPROPER CONNECTION CAN RESULT IN A RISK OF ELECTRIC SHOCK.

If an extension cord is necessary, it must be a 3-conductor, No. 10 AWG (6.0mm) minimum, heavy-duty cord with ground. It must also be in good electrical condition and as short as possible, 25 ft (7.6m) maximum. Make sure that the pins on the plug of the extension cord are the same number, size, and shape as the AC power cord plug on the charger. The use of an improper extension cord could result in a risk of fire or electrical shock.

Locate all cords so that they will not be stepped on, tripped over, or otherwise subjected to damage, stress, or accidentally disconnected.

⚠ CAUTION: VERIFY THAT THE AC POWER CORDSET IS FULLY ENGAGED IN THE IEC INLET AND CANNOT BE PULLED LOOSE BEFORE USING THE CHARGER.

⚠ DANGER: RISK OF ELECTRIC SHOCK! CONNECT THE AC SUPPLY CORDSET DIRECTLY TO A GROUNDED, 3-WIRE OUTLET. DO NOT TOUCH UNINSULATED PORTION OF DC OUTPUT TERMINALS OR BATTERY TERMINALS. REPLACE DEFECTIVE CORDS, WIRES, OR CONNECTORS IMMEDIATELY.

6 DC OUTPUT

⚠ WARNING: LEAD-ACID BATTERIES GENERATE EXPLOSIVE GAS. CHARGE ONLY IN WELL VENTILATED AREAS. TO PREVENT ARCING OR BURNING NEAR BATTERIES, DO NOT DISCONNECT THE DC CHARGING CONNECTOR(S) FROM THE BATTERIES WHEN THE CHARGER IS OPERATING. IF THE CHARGE CYCLE MUST BE INTERRUPTED, UNPLUG THE AC POWER CORD BEFORE DISCONNECTING THE DC OUTPUT CONNECTOR(S) FROM THE BATTERIES. KEEP SPARKS, FLAME, AND SMOKING MATERIALS AWAY FROM BATTERIES. TO REDUCE THE RISK OF FIRE, DO NOT USE THE CHARGER NEAR FLAMMABLE MATERIALS OR VAPORS.

Only charge batteries of the same type, voltage, number of cells, and amp-hour capacities listed on the charger ratings label. Before (1) using the charger for the first time or (2) using the charger with a battery pack of a different type or capacity, use the ChargerConnect app to verify that the proper active battery profile is selected (see Section 8).

6.1 Auto Voltage Mode

The 1425W charger models support automatic multi-voltage DC charging, referred to as Auto Voltage Mode. Auto Voltage Mode provides automatic DC output voltage detection and adjustment so that battery packs of nominal 36V and 24V can be charged with a single charger without any configuration changes needing to be made to the charger when switching between battery packs of different nominal voltages.

When connected to a 1425W charger model with the ChargerConnect app (see Section 8), the “System Profile” screen will include an “Auto Profile” selection box, which provides the following three (3) options:

- **OFF:** Single voltage mode – you **MUST** ensure that the nominal DC voltage of the “Active Battery Profile” for the charger matches the nominal DC voltage of the connected battery pack.
- **PER VOLTAGE PROFILES:** A battery profile can be assigned for 36V and a different battery profile can be assigned for 24V. The proper battery profile is automatically selected based on the connected battery pack. This mode is primarily used when the charger will be charging 36V and 24V nominal battery packs where the battery packs are of different types and/or capacities so using the “Scalable Profile” mode is not appropriate.
- **SCALABLE PROFILE:** The nominal DC voltage of the “Active Battery Profile” is automatically scaled to 36V or 24V based on the connected battery pack.

NOTE: If the charger is currently set to “Per Voltage Profiles” or “Scalable Profile” mode, and you set the “Auto Profile” selection box to “Off”, you **MUST ensure that the nominal DC voltage of the “Active Battery Profile” for the charger matches the nominal DC voltage of the connected battery pack via the “Battery Profiles” screen in the ChargerConnect app.**

When Auto Voltage Mode is active (either “Per Voltage Profiles” or “Scalable Profile”) the ChargerConnect app “Dashboard” screen provides the status of the proprietary algorithm that executes at the beginning of the charge cycle by displaying the “Auto Battery Voltage Detection” as a status percentage and the “Detected Battery Pack Voltage”.

6.2 DC Output Cordset

The DC output cordset includes a connector, plug, or terminals. The polarity of the charger DC connector/plug/terminals must be the same as the battery connector/receptacle/terminals. The BLACK DC cable must be connected to the battery negative (-), and the WHITE or RED DC cable must be connected to the battery positive (+). The charger will not operate if the polarity is reversed.

 **WARNING: CHARGER DC CORDSET MUST HAVE A MINIMUM OF 10AWG WIRE SIZE FOR PROPER HEAT DISSIPATION. TO PREVENT RISK OF FIRE, DO NOT USE SMALLER GAUGE WIRE.**

The DC cordset attaches to the external DC terminal block on the charger. Remove the touch proof cover (if pre-installed) to expose the DC terminal block as shown in Figure 6.2-1. Based on the DC cordset connector/plug/terminals, use Table 6.2 to determine the correct Configuration Number, and then attach the DC cordset wires as shown in Figure 6.2-2. Torque the screws for the battery connections to 18 in-lbs (2.0 N-m) and the lockout and external temperature sense connections to 12 in-lbs (1.35 N-m). Place the strain relief over the DC cordset cable/wires. When individual wires are used for on-board applications, place the foam rubber gasket that comes on the cordset under the strain relief, center the wires, and then tighten the strain relief nuts and torque them to 12 in-lbs (1 N-m). This prevents the wires from getting pinched on the side of the strain relief when tightened. Replace the terminal block cover, and torque the cover screws to 9 in-lbs (1 N-m).

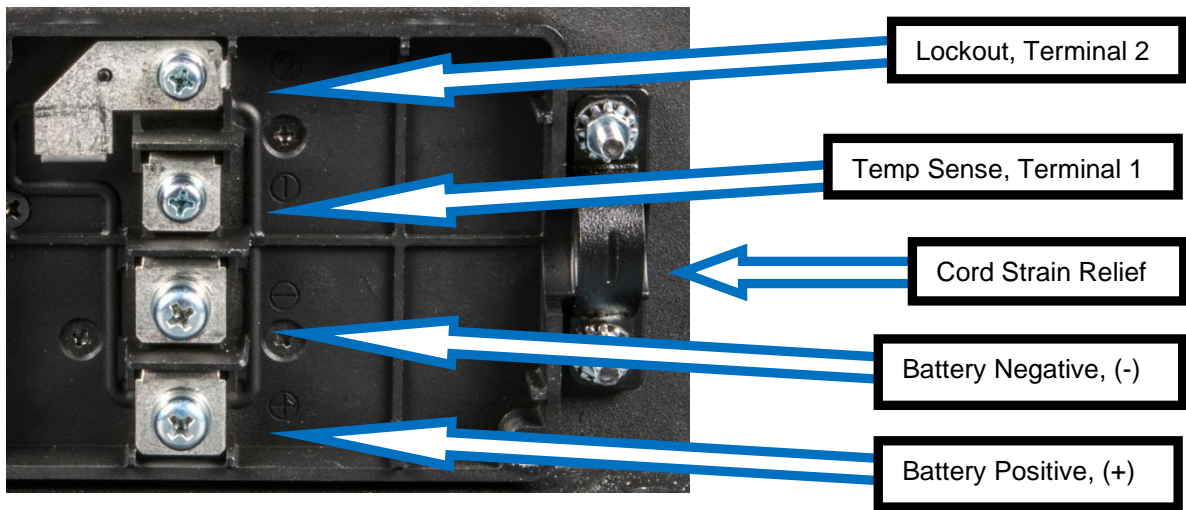

Figure 6.2-1: DC Terminal Block

Number of Wires	DC Connector	Connector Image	Configuration #
2	Anderson SB50		1
2	Anderson SB175		1
2	2-Blade Gray Molded (Crowsfoot)		1
2	Ring Terminals		1
3	Ring Terminals with QD Lockout		2
4	Ring Terminals with QD Lockout & Temperature Sensor		3

Table 6.2: Common DC Output Connector Configurations

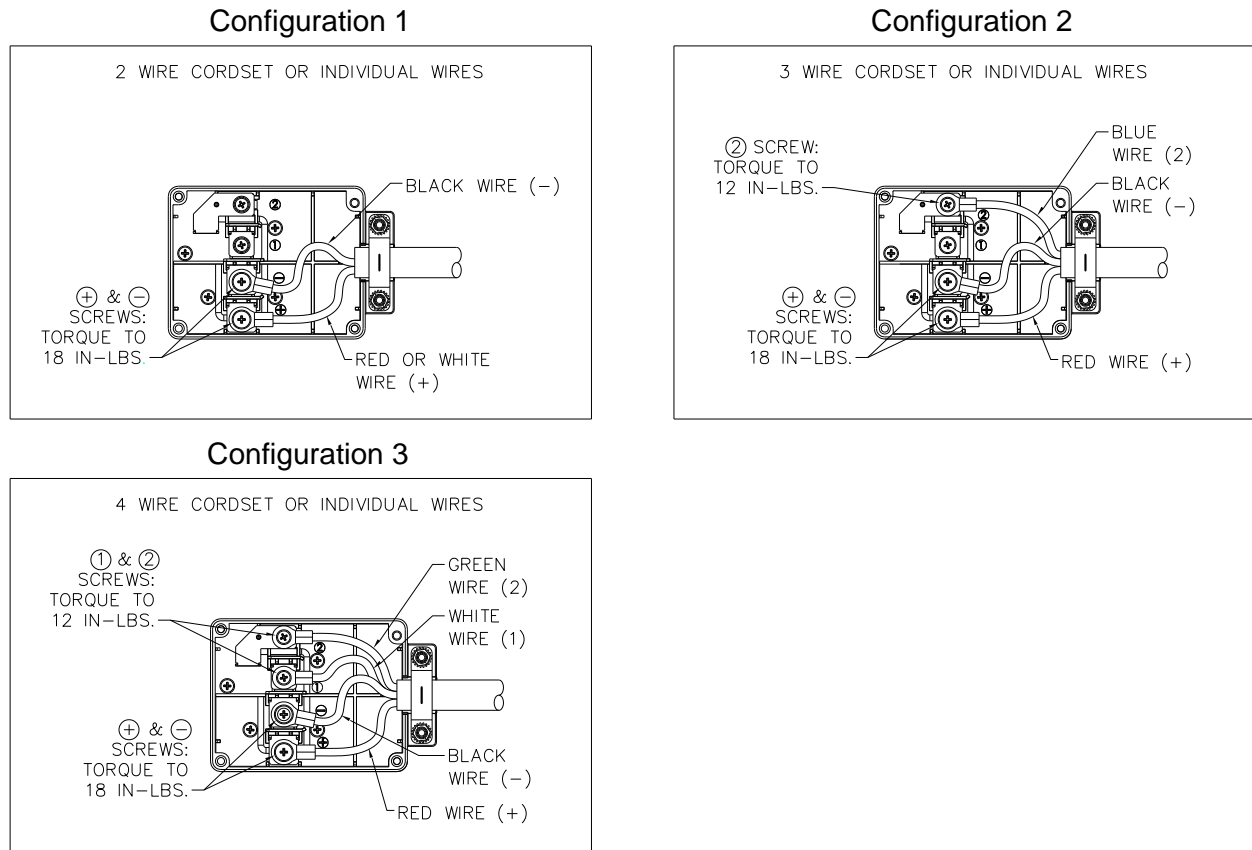

Figure 6.2-2: DC Terminal Block Configurations

7 VEHICLE LOCKOUT CONTROL

The charger lockout/interlock control signal can be interfaced with the vehicle/equipment to prevent use/movement of the vehicle while the charger is in use. The lockout control signal, available on Terminal 2 on the DC terminal block (see Figure 6.2-1), is internally pulled high through a 10k ohm resistor to battery positive (+) when lockout is not active and is pulled low to < 1 Vdc when lockout is active. The lockout control signal is typically interfaced with the vehicle motor speed controller. If you are uncertain of how to interface the lockout control signal with your vehicle, please contact your vehicle dealer.

If the charger is configured for on-board use, the lockout control signal will be active while AC power is applied to the charger. If the charger is configured for off-board use, the lockout control signal will be active while a valid battery is connected to the charger. Based on your application, you can configure the charger as on-board or off-board via the ChargerConnect app under "System Profile" (see Section 8).

8 BLUETOOTH® WIRELESS

The charger features Bluetooth wireless communication, which can be accessed using an Apple® or Android™ smart phone, tablet, or similar device. Download the ChargerConnect app for your device by scanning the QR code on the charger or visiting the App Store® or the Google Play™ store and searching for "ChargerConnect".

The charger communication electronics are DC powered, so the charger must be connected to a valid battery pack in order to communicate with it via Bluetooth. If the charger is connected to a valid battery pack, open the ChargerConnect app and select the charger from the list of available units the app is able to communicate with. The charger serial number is the identifier of the unit, unless the “Charger ID” has been previously changed via the app. While connected, the Red, Yellow, and Green LEDs on the charger will slowly blink at the same time until the Bluetooth communication is disconnected from the charger.

The following is a list of functionality available via the ChargerConnect app:

- “Dashboard” display of charging status
 - Charger ID, Vehicle ID, Battery Profile
 - LED Status, Charge Status, AC Present, Faults
 - Charge Time Remaining, Output Current, Amp-Hours Returned, Battery Voltage, Battery State of Charge (SOC)
 - Auto Battery Voltage Detection Status (if enabled)
 - Detected Battery Pack Voltage (if enabled)
 - Manual Stop/Start of a Charge Cycle
 - Manual Initiation of an Equalize/Balance Cycle
- “Diagnostics” display of real-time data
 - Ammeter for output current
 - Voltmeter for battery voltage
 - Battery State of Charge (SOC), Charge Time Remaining, Charge Cycle Phase, Amp-Hours Returned, Faults, AC Input Voltage, Battery Temperature (if a sensor is present)
- “History” of charge cycle data
 - “Charger Histories” tab
 - Overview:
 - Charger: Total Charge Cycles, Total Amp-Hours
 - Device: Total Charge Cycles, Last Charge Cycle
 - Cloud: Total Charge Cycles, Last Charge Cycle
 - Get 10 Records button
 - Get All Records button
 - Delete All Records button
 - Records section where individual records that have been downloaded from the charger can be selected to view the charge cycle details
 - “Cloud Histories” tab where all records from the “Charger Histories” tab can be uploaded to the Cloud for access via ChargerConnect.com using the charger serial number
- “System Information” (display only)
 - Serial Number, Model Number, Charge Control Firmware Version, Power Control Firmware Version, Hardware Version
 - Vehicle ID, Battery Information
- “System Profile”
 - “Charger Profiles” tab (all items are settable)
 - Charger ID, Vehicle ID, DC Cable Gauge (AWG), DC Cable Length (feet), On Board check box (checked = on-board, unchecked = off-board)
 - Auto Voltage Profile (see Section 6.1)
 - “Device Profiles” tab enables System Profiles that reside on the smart phone or tablet (device) to be uploaded to the charger
 - “Cloud Profiles” tab enables System Profiles to be downloaded from the Cloud to the smart phone or tablet (device)
- “Battery Profiles”
 - “Charger Profiles” tab
 - Set the “Active Battery Profile” via the check mark
 - Question mark buttons provide detailed descriptions of the battery profiles
 - “Device Profiles” tab enables Battery Profiles that reside on the smart phone or tablet (device) to be uploaded to the charger
 - “Cloud Profiles” tab enables Battery Profiles to be downloaded from the Cloud to the smart phone or tablet (device)
 - “Profile Selector” tab helps you select the proper battery profile for the particular battery (listed by manufacture and model) being used in your application.
- “Help” provides more in-depth information regarding the ChargerConnect app

⚠ CAUTION: CHANGES OR MODIFICATIONS NOT EXPRESSLY APPROVED BY THE PARTY RESPONSIBLE FOR COMPLIANCE COULD VOID THE USER'S AUTHORITY TO OPERATE THE EQUIPMENT.

This equipment has been tested and found to comply with the limits for a Class A digital device, pursuant to part 15 of the FCC and ICES-003 Rules. These limits are designed to provide reasonable protection against harmful interference when the equipment is operated in a commercial environment. This equipment generates, uses and can radiate radio frequency energy and, if not installed and used in accordance with the instruction manual, may cause harmful interference to radio communications. Operation of this equipment in a residential area is likely to cause harmful interference in which case the user will be required to correct the interference at his own expense.

9. EXTERNAL PORT

The charger has an external port with a sealed DB9 (DE9) connector located near the DC terminal block which is used for the remote LED and/or CAN communication cable assemblies. When this port is not being used, leave the protective cover over the connector to keep moisture and debris out of the connector.

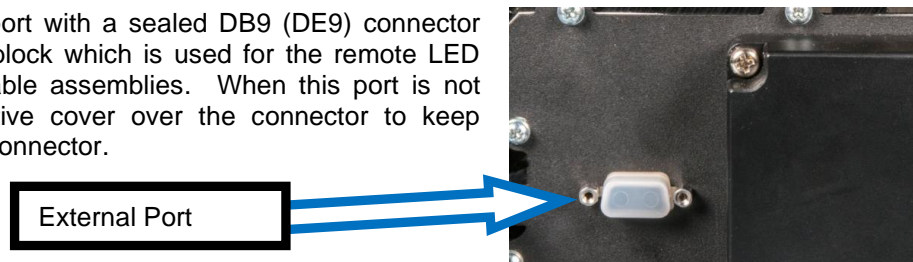

When mounting the charger on-board a vehicle where the charger LEDs are not visible, a remote LED cable assembly can be used. Attach the remote LED cable assembly to the external port on the charger and hand tighten the connector mounting screws. The LED end of the cable assembly is to be rear mounted through a hole on the vehicle or it can be attached to a panel which mounts to the vehicle. Install the remote LED assembly as shown. Remote LED blink patterns are detailed in Section 12.3.

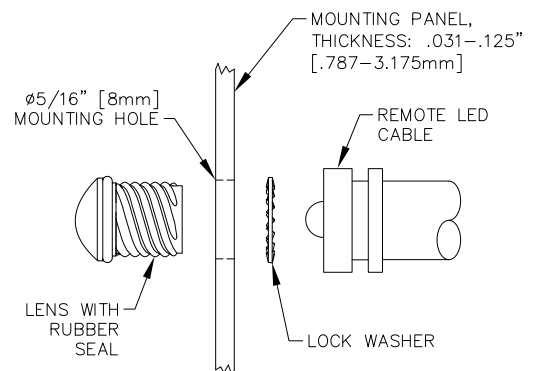

10. PROPER CARE OF DEEP-CYCLE LEAD-ACID MOTIVE POWER BATTERIES

Motive power battery packs are subjected to severe deep-cycle duty on a daily basis. Although these batteries are designed to withstand such duty, the following precautions must be observed to obtain good performance and maximum cycle life.

⚠ CAUTION: ALWAYS WEAR PROTECTIVE EYE SHIELDS AND CLOTHING WHEN WORKING WITH BATTERIES. BATTERIES CONTAIN ACIDS WHICH CAN CAUSE BODILY HARM. DO NOT PUT WRENCHES OR OTHER METAL OBJECTS ACROSS THE BATTERY TERMINAL OR BATTERY TOP. ARCING OR EXPLOSION OF THE BATTERY CAN RESULT.

1. When installing new batteries, be sure the polarity of each battery and the overall battery pack is correct. Otherwise, battery and/or charger damage can result.
2. New batteries should be given a full charge before their first use because it is difficult to know how long the batteries have been stored.
3. New batteries and older batteries that have been in storage are not capable of their rated output until they have been discharged and charged a number of times. Consult the manufacturer of your batteries for more information.
4. **DO NOT EXCESSIVELY DISCHARGE THE BATTERIES.** Excessive discharge can cause polarity reversal of individual cells resulting in complete failure shortly thereafter.

-
5. Maintain the proper electrolyte level of wet (flooded) batteries by adding water when necessary. Distilled or deionized water is best for battery life. Never allow the electrolyte level to fall below the top of the battery plates. Electrolyte levels lower during discharge and rise during charge. Therefore, to prevent the overflow of electrolyte when charging, it is mandatory that water be added to cells AFTER they have been fully charged – do not overfill. Old batteries require more frequent additions of water than new batteries.
 6. Hard crystalline sulfates form when batteries in storage are not maintained in a charged active state. Internal self discharge can bring about the start of this condition in as little as three days in warm temperatures. Batteries not maintained and allowed to sit in storage will self discharge, sulfate and lose capacity. Repeated charging without using the batteries between charges can recover some of the lost power, range, and life, but some permanent loss should be expected.
 7. Cold batteries require more time to fully charge. When the temperature falls below 65°F, the batteries should be placed on charge as soon after use as possible.
 8. The tops of batteries and battery hold downs must be kept clean and dry at all times to prevent excessive self discharge and the flow of current between the battery posts and frame. Electrolyte spilled on batteries never dries or evaporates.
 9. All connections to batteries must be maintained clean and tight. Due to heating and discharge rates, bolted connections loosen over time. Re-tighten the connections twice yearly to the torques specified by the battery manufacturers.
 10. Follow all operating instructions, cautions, and warnings as specified in this manual, on the charger, in the battery manuals, and in the vehicle manuals.

10.1 Personal Safety Precautions

1. Have someone within the range of your voice and close enough to quickly come to your aid when you work near a lead-acid battery.
2. Ensure that ample fresh water and soap are nearby in case battery acid contacts your skin, clothing, or eyes.
3. Wear complete eye and clothing protection. Avoid touching your eyes while working near a battery.
4. If battery acid contacts your skin or clothing, wash immediately with soap and water. If acid enters your eye, immediately flush your eye with running cold water for at least 10 minutes, and get medical attention immediately.
5. NEVER smoke or allow a spark or flame to be in the vicinity of a battery.
6. Be extra cautious to reduce the risk of dropping a metal tool onto a battery. It could spark or short circuit the battery or other electrical components that could cause an explosion.
7. Remove personal metal items such as rings, bracelets, necklaces, and watches when working with a battery. A battery can produce a short-circuit current that is high enough to cause a severe burn.
8. NEVER charge a frozen battery.

11. CHARGER OPERATION

 **WARNING: TO REDUCE THE RISK OF AN ELECTRIC SHOCK, CONNECT ONLY TO A SINGLE-PHASE, PROPERLY GROUNDED (3-WIRE) OUTLET. REFER TO GROUNDING INSTRUCTIONS.**

 **CAUTION: MAKE SURE THE BATTERY IS A RECHARGEABLE DEEP-CYCLE BATTERY WITH THE PROPER RATED VOLTAGE FOR THIS CHARGER.**

 **DANGER: TO PREVENT ELECTRICAL SHOCK, DO NOT TOUCH UNINSULATED PARTS OF THE CHARGER DC OUTPUT CONNECTOR, BATTERY CONNECTOR, OR BATTERY TERMINALS. MAKE SURE ALL ELECTRICAL CONNECTORS ARE IN GOOD WORKING CONDITION. DO NOT USE CONNECTORS THAT ARE CRACKED, CORRODED, OR DO NOT MAKE ADEQUATE ELECTRICAL CONTACT. USE OF A DAMAGED OR DEFECTIVE CONNECTOR MAY RESULT IN A RISK OF OVERHEATING OR ELECTRIC SHOCK.**

 **WARNING: CHARGER IS NOT TO BE USED WHILE THE BATTERY POWERED EQUIPMENT IS OPERATING.**

⚠ ATTENTION: NE PAS UTILISER LE CHARGER PENDANT QUE L'EQUIPMENT EST EN MARCHE.

⚠ WARNING: LEAD-ACID BATTERIES GENERATE GASES WHICH CAN BE EXPLOSIVE. TO PREVENT ARCING OR BURNING NEAR BATTERIES, DO NOT DISCONNECT THE CHARGER DC OUTPUT FROM THE BATTERIES WHEN THE CHARGER IS OPERATING. KEEP SPARKS, FLAME, AND SMOKING MATERIALS AWAY FROM BATTERIES.

⚠ WARNING: ALWAYS SHIELD EYES WHEN WORKING NEAR BATTERIES. DO NOT PUT WRENCHES OR OTHER METAL OBJECTS ACROSS BATTERY TERMINALS OR THE BATTERY TOP. ARCING OR EXPLOSION OF THE BATTERY CAN RESULT!

⚠ WARNING: DO NOT DISCONNECT THE CHARGER DC OUTPUT CONNECTOR FROM THE BATTERY CONNECTOR WHILE A CHARGE CYCLE IS IN PROGRESS. THE RESULTING ARCING AND BURNING OF THE CONNECTORS COULD CAUSE THE BATTERIES TO EXPLODE.

⚠ CAUTION: TO AVOID DAMAGE TO THE CHARGER DC CABLE AND CONNECTOR AND BATTERY CONNECTOR, DISCONNECT BY GRASPING THE CHARGER CONNECTOR HANDLE OR BODY AND PULLING IT STRAIGHT OUT OF THE BATTERY CONNECTOR. DO NOT PULL ON THE CHARGER CABLE. DO NOT TWIST, ROCK, OR PULL THE CONNECTOR SIDEWAYS.

The instructions printed on the charger are for daily reference.

11.1 Off-Board Charger Operation

If the charger was configured for off-board use, follow these operating instructions:

1. With the charger DC output connector/plug disconnected from the battery connector/receptacle, connect the charger AC power cord to an appropriate AC outlet (if not already connected) and the blue "AC PRESENT" LED will turn on.
2. Connect the charger DC output connector/plug to the battery connector/receptacle. The charger will start automatically, which is indicated by the yellow "CHARGE STATUS" LED beginning to blink slowly.
3. If the charger must be disconnected from the battery while a charge cycle is in progress, first disconnect the AC power cord from the AC outlet. Do not disconnect the charger DC output connector/plug from the battery while a charge cycle is in progress.
4. The charge cycle 80% point is indicated by the yellow LED beginning to blink quickly.
5. The Finish charge cycle phase is indicated by the solid illumination of the yellow LED. Not all charge profiles include a Finish phase.
6. An extended Balance/Equalize charge cycle phase is indicated by the green "CHARGE COMPLETE" LED beginning to blink quickly. Not all charge profiles include a Balance/Equalize phase.
7. The charger automatically terminates the charge cycle when a battery reaches full charge, which is indicated by [1] the solid illumination of the green LED or [2] the green LED beginning to blink slowly indicating a post-charge phase. The required charge time is affected by numerous factors, including battery amp-hour capacity, depth of discharge, battery temperature, and battery age/usage.
8. Before operating the machine/equipment, disconnect the charger DC output connector/plug from the battery connector/receptacle by firmly grasping both connectors and pulling them straight apart.

11.2 On-Board Charger Operation

If the charger was configured for on-board use, follow these operating instructions:

1. Ensure that the vehicle/equipment that the charger is mounted on is turned off.
2. With the charger AC power cord disconnected from the AC outlet, connect the charger DC output connector/plug to the battery connector/receptacle (most likely already connected or hard wired).
3. Connect the charger AC power cord to an appropriate live AC outlet which is indicated by the blue "AC PRESENT" LED turning on. The charger will start automatically as indicated by the yellow "CHARGE STATUS" LED beginning to blink slowly.
4. If the charger must be disconnected from the battery while a charge cycle is in progress, disconnect the AC power cord from the AC outlet. Do not disconnect the charger DC output connector/plug from the battery while a charge cycle is in progress.
5. The charge cycle 80% point is indicated by the yellow LED beginning to blink quickly.
6. The Finish charge cycle phase is indicated by the solid illumination of the yellow LED. Not all charge profiles include a Finish phase.
7. An extended Balance/Equalize charge cycle phase is indicated by the green "CHARGE COMPLETE" LED beginning to blink quickly. Not all charge profiles include a Balance/Equalize phase.
8. The charger automatically terminates the charge cycle when a battery reaches full charge, which is indicated by [1] the solid illumination of the green LED or [2] the green LED beginning to blink slowly indicating a post-charge phase. The required charge time is affected by numerous factors, including battery amp-hour capacity, depth of discharge, battery temperature, and battery age/usage.
9. Before operating the vehicle/equipment, disconnect the charger AC power cord from the outlet.

11.3 Storage Mode Operation

1. Storage Mode is designed to keep your battery maintained during storage periods that last a few weeks to several months at a time.
2. Depending on the battery type and battery profile selected, a storage charge can be a continuous float or a periodic charge mode.
3. Do NOT disconnect the charger from the battery or from the AC power until your machine is needed for use. Disconnecting and reconnecting the charger from the batteries or AC power may start a charge cycle, but disconnection disrupts the storage mode so optimum battery maintenance is not achieved.
4. After several months of storage your batteries should be serviced and the charger reset by disconnecting the DC for Off-Board or the AC for On-Board applications (disconnect AC for a minimum of 10 minutes) before continuing another storage season.

12. LED INDICATORS

The charger has four (4) LEDs to indicate charger status and fault information. The functionality of the LEDs is outlined below and explained in the table below.

12.1 Charger LED Status

The functionality of the LEDs is outlined below and in the following table.

- **AC PRESENT (Blue)** - Indicates charger is connected to a live AC inlet.
- **FAULT (Red)** - Indicates when a charger or battery fault has occurred (see section 12.2 for more information).
- **CHARGE STATUS (Yellow)** - Indicates charge cycle status.
- **CHARGE COMPLETE (Green)** - Indicates when a charge cycle completes successfully, when an extended Balance/Equalize charge cycle phase is active, or when a post-charge phase is active.

FAULT (Red) LED	CHARGE STATUS (Yellow) LED	CHARGE COMPLETE (Green) LED	DESCRIPTION
Solid On	Solid On	Solid On	LED check for a few seconds during charger initialization
	Slow Blink	Off	Bulk/Start charge cycle phase (constant power or constant current).
	Fast Blink	Off	Absorption/Plateau charge cycle phase (constant voltage). Greater than 80% charged.
	Solid On	Off	Finish charge cycle phase (constant current). Not all charge profiles include a Finish phase.
	Off	Fast Blink	Balance/Equalize phase. An extended charge cycle is occurring because a trigger condition has been met (cycle count, etc). Not all charge profiles include a Balance/Equalize phase.
	Off	Solid On	Charge cycle complete.
	Off	Slow Blink	Charge cycle complete. Post Charge phase (constant voltage float, etc). Not all charge profiles include a Post Charge phase.
Slow Blink	Slow Blink	Slow Blink	Charger Bluetooth connected to a smart phone or device, LEDs blink at the same time

12.2 Charger LED Faults

The charger will indicate when a fault occurs by using different patterns of the Fault (Red), Charge Status (Yellow), and Charge Complete (Green) LEDs as explained in the table below. Using the ChargerConnect App, check the diagnostic tab to get a description of the charger fault.

	FAULT (Red) LED	CHARGE STATUS (Yellow) LED	CHARGE COMPLETE (Green) LED	DESCRIPTION
Charger	Slow Blink	Off	Off	NO AC – AC power was lost during charging. Charge cycle was halted and will restart when AC power returns.
	Slow Blink	Slow Blink	Slow Blink	BLUETOOTH FAULT – Bluetooth communication issue indicated by LEDs blink one at a time in a rotating pattern. Contact Lester Electrical. Unit is still able to charge.
	Slow Blink	Slow Blink	Solid On	PROFILE MISMATCH – Charger has detected a battery profile problem.
	Slow Blink	Fast Blink	Slow Blink	LOW TEMP – Temperature is too low to start a charge cycle (< -25°C). Charging will start when temperature increases.
	Slow Blink	Fast Blink	Fast Blink	LIMIT FAULT – An over/under limit condition was detected causing charge to stop. Charge may restart if issue was temperature related and readings return to normal.
	Slow Blink	Solid On	Slow Blink	INTERNAL HARDWARE FAULT – Contact Lester Electrical.
	Slow Blink	Solid On	Solid On	COMMUNICATION – CAN communication failure has occurred.
	Fast Blink	N/A	N/A	EXTERNAL HARDWARE FAULT – Charger has detected an open or shorted lockout wire or a temperature probe fault. Unit is still able to charge.
Battery	Solid On	Off	Off	PHASE – A fault condition was met during a particular charge cycle phase (start/bulk, plateau/absorption, finish, etc.) or fault sent to charger externally via CAN communication.
	Solid On	Off	Slow Blink	MAX VOLTAGE – Maximum voltage was met.
	Solid On	Off	Solid On	MIN VOLTAGE – Minimum voltage was NOT met after a specified time from the start of the charge cycle.
	Solid On	Slow Blink	Off	MAX AMP-HOURS – Maximum amp-hours for the phase or overall charge cycle was met.
	Solid On	Slow Blink	Slow Blink	MAX TIME – Maximum time for the phase or overall charge cycle was met.
	Solid On	Solid On	Slow Blink	MAX BATTERY TEMPERATURE – External battery temperature sensor increased above limit and stopped charging.
	Solid On	Solid On	Fast Blink	BATTERY FAULT – Pre-set battery criteria above critical limits and charging stopped.

N/A = Not applicable, LED state does not matter

Disconnecting the charger from the battery always clears a fault. If the charger was factory-configured for on-board use, removing AC power from the charger also clears a fault. If a fault cannot be cleared after taking appropriate corrective action, contact your dealer for troubleshooting and/or service.

13. TROUBLESHOOTING

The charger was fully tested and calibrated before leaving the factory. It was delivered ready to charge. If properly installed, the charger should require very little attention. If improper charger operation occurs, it will require repair by a qualified service technician (see section 12.1 for information regarding the Fault LED).

⚠ CAUTION: DO NOT OPERATE THE CHARGER IF IT IS DAMAGED OR APPEARS TO BE MALFUNCTIONING. PERSONAL INJURY OR DAMAGE TO THE CHARGER OR BATTERIES MAY RESULT. DO NOT DISASSEMBLE THE CHARGER. CONTACT YOUR DEALER. INCORRECT REASSEMBLY MAY RESULT IN RISK OF ELECTRIC SHOCK OR FIRE.

1. If the charger does not turn on, check for one of the following conditions.
 - a. The charger AC power cord is not plugged into a live and/or appropriate AC outlet.
 - b. The battery connections are incorrect – battery not connected, reverse polarity, or short circuit.
 - c. The battery voltage is too high.
 - d. The battery voltage is too low (below 10 volts).
2. If the charger turns off before a battery is fully charged, and a fault condition is not indicated by the Fault LED, this indicates one of the following conditions.
 - a. The AC power was interrupted during the charge cycle.
 - b. The charger DC output connector was disconnected from the battery during the charge cycle.
 - c. The battery has been allowed to sulfate. Charge the battery at least once every three (3) days when the equipment is lightly used. Once sulfation is allowed to take place, it may be partially reduced by returning, temporarily, to daily charging.
3. A decrease in vehicle/equipment range where the battery loses power faster indicates one of the following conditions.
 - a. The electrolyte level in a wet lead-acid battery was allowed to drop below the top of the battery plates. If so, add distilled water to just cover the top of the plates immediately upon discovery, and then fill to the proper level with distilled water at the completion of the very next charge cycle.
 - b. Use of the vehicle/equipment before the battery has been fully charged and the charger automatically terminates the charge cycle. This shortens battery life and accelerates the onset of reduced daily range.
 - c. The normal wear-out pattern for the battery.
4. A charge cycle running longer than anticipated before terminating indicates one of the following conditions.
 - a. An overly discharged battery.
 - b. The charger output may have been reduced due to low AC input voltage, high ambient temperature, or obstructions to cooling airflow.
 - c. The amp-hour capacity of the battery is greater than the charger can fully charge in the anticipated amount of time.

14. SPECIFICATIONS

See the 1425W Summit II datasheet for specifications.

The Bluetooth® word mark and logos are registered trademarks owned by Bluetooth SIG, Inc., and any use of such marks by Lester Electrical is under license. Other trademarks and trade names are those of their respective owners.

Apple is a trademark of Apple Inc., registered in the U.S. and other countries. App Store is a service mark of Apple Inc., registered in the U.S. and other countries.

Android is a trademark of Google Inc. Google Play and the Google Play logo are trademarks of Google Inc.

15. SERVICE PART LIST

All models: 24V Model 29500, 36V Model 29600, 36-48V Model 30500

Description	Lester Part Number
Cordset, AC, 14/3, 125V/10A, 78"	41589S
Handle Kit (handle with screws)	42117S
DC Terminal Block Cover Kit (cover with screws)	42204S
6ft Remote LED Cable	41874S
12ft Remote LED Cable	42317S
2 Wire, 8AWG, 9ft, DC Cordset with SB50 Gray Plug	42397S
2 Wire, 8AWG, 9ft, DC Cordset with SB50 Red Plug	42398S
2 Wire, 8AWG, 9ft, DC Cordset with SB175 Gray Plug	42399S
2 Wire, 8AWG, 9ft, DC Cordset with SB175 Red Plug	42401S
2 Wire, 10AWG, 9ft, DC Cordset with Lester 2-blade Gray Molded Plug	42026S
2 Wire, 2-10AWG, 3ft, DC Cordset with Ring Terminals	42016S
2 Wire, 2-10AWG, 6ft, DC Cordset with Ring Terminals	42017S
2 Wire, 2-10AWG, 9ft, DC Cordset with Ring Terminals	42927S
3 Wire, 2-10AWG, 1-16AWG, 3ft, DC Cordset with Ring Terminals (LO)	42018S
3 Wire, 2-10AWG, 1-16AWG, 6ft, DC Cordset with Ring Terminals (LO)	42019S
4 Wire, 2-10AWG, 2-16AWG, 3ft, DC Cordset with Ring Terminals (LO, Temp)	42217S
4 Wire, 2-10AWG, 2-16AWG, 6ft, DC Cordset with Ring Terminals (LO, Temp)	42218S

LO = Lockout, Temp = Battery Temperature Sensor

NOTES



Represented By:



42156 D

