



# LINKS

## SERIES™



### USER'S MANUAL

Industrial Battery Charger

---

*Important Safety,  
Installation,  
Operation, and  
Maintenance  
Instructions*

---



*Lester*  **Electrical** 

[www.LesterElectrical.com](http://www.LesterElectrical.com)

## CHARGER RATINGS LABEL

The ratings label is located on the back of the charger. The label provides the model (MODEL), serial number (SERIAL NO.), AC input configuration (AC VOLTS, AC AMPS, PHASE and HERTZ) and DC output specifications (CELLS, DC VOLTS, DC AMPS and AMP-HRS) of the charger. TYPE indicates the factory-configured battery type and if the charger is configured for on-board operation.

An example charger ratings label is provided below.

SERIAL		161200001		LESTER ELECTRICAL	
				625 West A Street	
MODEL		26070A01A1S1W1A1		Lincoln, NE 68522, USA	
26070		Industrial Battery Charger			
AC VOLTS		AC AMPS	PHASE	HERTZ	
120		11.5	1	60	
DC VOLTS	DC AMPS	AMP HRS	TYPE		CELLS
48	17	105-210	WET		24



161200001

Please fill in the blank label that is provided below with the information from the ratings label on your charger for future reference.

SERIAL				LESTER ELECTRICAL	
				625 West A Street	
MODEL				Lincoln, NE 68522, USA	
		Industrial Battery Charger			
AC VOLTS		AC AMPS	PHASE	HERTZ	
DC VOLTS	DC AMPS	AMP HRS	TYPE		CELLS



Document any configuration or settings changes that are made by marking the ratings label on your charger or on an additional label or tag attached to your charger.

**SAVE THIS MANUAL: Keep it in a location where it is available to anyone who may operate the charger.**

This equipment has been tested and found to comply with the limits for a Class A digital device, pursuant to part 15 of the FCC Rules. These limits are designed to provide reasonable protection against harmful interference when the equipment is operated in a commercial environment. This equipment generates, uses and can radiate radio frequency energy and, if not installed and used in accordance with the instruction manual, may cause harmful interference to radio communications. Operation of this equipment in a residential area is likely to cause harmful interference in which case the user will be required to correct the interference at his own expense.

---

## TABLE OF CONTENTS

CHARGER RATINGS LABEL .....	2
TABLE OF CONTENTS .....	3
IMPORTANT SAFETY INSTRUCTIONS .....	4
1. INTRODUCTION .....	6
2. RECEIVING THE CHARGER.....	6
3. STORAGE.....	6
4. BATTERY TYPE .....	6
5. OFF-BOARD (SHELF) CHARGING.....	7
6. LOCATION AND INSTALLATION .....	8
7. AC INPUT.....	8
8. DC OUTPUT.....	9
8.1 ROUND MOLDED 3-PIN PLUG.....	9
8.2 DC OUTPUT FUSE .....	9
9. PROPER CARE OF DEEP-CYCLE MOTIVE POWER BATTERIES .....	10
9.1 Personal Safety Precautions .....	10
10. CHARGER OPERATION .....	11
10.1 User Interface.....	12
11. MAINTENANCE .....	13
11.1 Check Charger Area .....	13
11.2 Visual Inspections .....	13
11.3 Battery Conditions .....	13
12. TROUBLESHOOTING AND SERVICE.....	13













---

## **IMPORTANT SAFETY INSTRUCTIONS**

1. **SAVE THESE INSTRUCTIONS** – This manual contains important safety and operating instructions.
2. Before using battery charger, read all instructions and cautionary markings on battery charger, battery, and product using battery.



**LOOK FOR THIS SYMBOL TO POINT OUT SAFETY PRECAUTIONS. IT MEANS: *BE ALERT—YOUR SAFETY IS INVOLVED.* IF YOU DO NOT FOLLOW THESE SAFETY INSTRUCTIONS, INJURY OR PROPERTY DAMAGE CAN OCCUR.**

3. ** DANGER:** TO REDUCE THE RISK OF FIRE OR ELECTRIC SHOCK, CAREFULLY READ AND FOLLOW THESE IMPORTANT SAFETY AND OPERATING INSTRUCTIONS BEFORE INSTALLING OR OPERATING THE CHARGER.
4. ** INSTRUCTIONS IMPORTANTES CONCERNANT LA SECURITÉ.**
5. ** WARNING:** TO REDUCE THE RISK OF FIRE, INSTALL THIS BATTERY CHARGER ON A SURFACE OF NON-COMBUSTIBLE MATERIAL SUCH AS BRICK, CONCRETE, OR METAL.
6. ** DANGER:** RISK OF ELECTRIC SHOCK. DISCONNECT CHARGER FROM BATTERY AND AC POWER BEFORE SERVICING. TURNING OFF THE CHARGER DOES NOT REDUCE THIS RISK.
7. ** DANGER:** RISK OF ELECTRIC SHOCK. DO NOT TOUCH UNINSULATED PORTION OF AC OR DC CONNECTORS OR UNINSULATED BATTERY TERMINAL.
8. ** DANGER:** RISQUE DE CHOCKS ÉLECTRIQUES. NE PAS TOUCHER LES PARTIES NON ISOLÉES DU CONNECTEUR DE SORTI OU LES BORNES NON ISOLÉES DE L'ACCUMULATEUR.
9. ** CAUTION:** CHARGE ONLY LEAD-ACID BATTERIES. OTHER TYPES OF BATTERIES MAY BURST CAUSING PERSONAL INJURY AND DAMAGE. BEFORE CHARGING ANY OTHER TYPE OF RECHARGEABLE BATTERY, CHANGE THE CHARGER SETTINGS AS RECOMMENDED BY THAT BATTERY MANUFACTURER.
10. ** ATTENTION:** UTILISER POUR CHARGER UNIQUEMENT LES ACCUMULATEURS AU PLOMB À ELECTROLYTE LIQUIDE. D'AUTRES TYPES D'ACCUMULATEURS POURRAIENT ÉCLATER ET CAUSER DES.
11. ** CAUTION:** DO NOT EXPOSE TO RAIN. INDOOR USE ONLY.
12. ** ATTENTION:** NE PAS EXPOSER À LA PLUIE.
13. ** DANGER:** TO PREVENT ELECTRICAL SHOCK, DO NOT TOUCH EITHER AC OR DC UNINSULATED PARTS. MAKE SURE ALL ELECTRICAL CONNECTORS ARE IN GOOD WORKING CONDITION. DO NOT USE CONNECTORS THAT ARE CRACKED, CORRODED OR DO NOT MAKE ADEQUATE ELECTRICAL CONTACT. USE OF A DAMAGED OR DEFECTIVE CONNECTOR MAY RESULT IN A RISK OF OVERHEATING OR ELECTRIC SHOCK.
14. ** WARNING:** HAZARD OF ELECTRIC SHOCK.

- 
15. **⚠ WARNING: LEAD-ACID BATTERIES GENERATE EXPLOSIVE GASES. TO PREVENT ARCING OR BURNING NEAR BATTERIES, DO NOT DISCONNECT DC CHARGING CORD FROM BATTERIES WHEN THE CHARGER IS OPERATING. KEEP SPARKS, FLAME, AND SMOKING MATERIALS AWAY FROM BATTERIES.**
  16. **⚠ WARNING: ALWAYS SHIELD EYES WHEN WORKING NEAR BATTERIES. DO NOT PUT WRENCHES OR OTHER METAL OBJECTS ACROSS BATTERY TERMINAL OR BATTERY TOP. ARCING OR EXPLOSION OF THE BATTERY CAN RESULT.**
  17. **⚠ WARNING: BATTERIES PRODUCE HYDROGEN GAS, WHICH CAN EXPLODE IF IGNITED. NEVER SMOKE, USE AN OPEN FLAME, OR CREATE SPARKS NEAR THE BATTERY. VENTILATE THE AREA WHEN THE BATTERY IS CHARGING IN AN ENCLOSED PLACE.**
  18. **⚠ WARNING: LEAD-ACID BATTERIES CONTAIN SULFURIC ACID, WHICH MAY CAUSE BURNS. DO NOT GET ACID IN EYES, ON SKIN, OR CLOTHING. IF CONTACT WITH THE EYES OCCURS, FLUSH IMMEDIATELY WITH CLEAN WATER FOR 15 MINUTES AND OBTAIN MEDICAL ATTENTION.**
  19. **⚠ WARNING: ONLY YOUR DEALER'S QUALIFIED SERVICE TECHNICIANS SHOULD PROGRAM OR SERVICE THIS EQUIPMENT.**
  20. **⚠ CAUTION: DO NOT OPERATE THE CHARGER IF IT HAS RECEIVED A SHARP BLOW, BEEN DROPPED, OR OTHERWISE DAMAGED. HAVE YOUR DEALER'S QUALIFIED SERVICE TECHNICIAN EXAMINE AND REPAIR AS NEEDED.**
  21. **⚠ WARNING: DO NOT DISASSEMBLE THE CHARGER. HAVE THE CHARGER EXAMINED BY YOUR DEALER'S QUALIFIED SERVICE TECHNICIAN. INCORRECT RE-ASSEMBLY OF THE CHARGER MAY RESULT IN AN EXPLOSION, ELECTRIC SHOCK, OR FIRE.**
  22. **⚠ CAUTION: MAKE SURE THE BATTERY SYSTEM HAS THE PROPERLY RATED VOLTAGE, AMP-HOURS, AND TYPE ("WET", "AGM", "GEL", ETC.) FOR THIS CHARGING SYSTEM.**
  23. **⚠ WARNING: NEVER CHARGE A FROZEN BATTERY**
  24. **⚠ WARNING: CONNECT AND DISCONNECT DC OUTPUT CORD ONLY AFTER REMOVING AC CORD FROM THE ELECTRICAL OUTLET.**
  25. **⚠ CAUTION: POSITION AC AND DC CORDS TO REDUCE RISK OF DAMAGE BY HOOD, DOOR OR MOVING ENGINE PART.**
  26. **⚠ DANGER: STAY CLEAR OF FAN BLADES, BELTS, FULLEYS, AND OTHER PARTS THAT CAN CASE INJURY TO PERSONS.**
  27. **⚠ CAUTION: CHECK POLARITY OF BATTERY POSTS. A POSITIVE (POS, P, +) BATTERY POST USUALLY HAS A LARGER DIMETER THAN NEGATIVE (NEG, N, -) POST.**

## **SAVE THESE INSTRUCTIONS**

---

## 1. INTRODUCTION

This Links Series battery charger is an advanced, microprocessor-based, silicon-controlled rectifier (SCR) charger designed to optimize both daily battery capacity and overall battery life. It plugs directly into standard 120V, 15A, 60 Hz AC outlets/receptacles for use in off-board (shelf) applications. The charger is natural convection cooled with no moving parts. It was factory-configured to charge wet, AGM, or gel deep-cycle lead-acid batteries, and includes an internal jumper that can be used to select between two battery profiles in the field. This charger features fully-automatic operation and an ammeter to monitor charge cycle status.

Figure 1-1 provides specifications for Links Series models 25970, 25940, 26070, & 27730.

Model Number	DC Output Volts	DC Output Amps	Amp-Hour Rating, C <sub>20</sub> Rate (12 Hrs)	AC Input Amps	Shipping Weight, Approx (LBS)
25970	36	21	130 - 225	11.5	37
25940	36	25	150 - 305	13.5	39
26070	48	17	105 - 210	11.5	39
27730	48	13	80 - 170	9.5	31

**Figure 1-1: Specifications for Links Series Models 25970, 25940, 26070, & 27730**

## 2. RECEIVING THE CHARGER

Unpack the charger and examine it for shipping damage. In the event that shipping damage is found, report it as a claim with the freight company.

## 3. STORAGE

When the charger is stored prior to being installed and powered up, it must be stored indoors in a clean and dry environment where the temperatures will remain within the range of -40 °F to 150 °F (-40 °C to 65 °C). The charger should be stored upright in the shipping carton that it was shipped in. This will help protect the charger from dust and abrasion. It should be stored in an area where it is not likely to be damaged. Do not stack anything on top of the charger.

## 4. BATTERY TYPE

**⚠ WARNING: DISCONNECT BOTH AC AND DC POWER FROM THE CHARGER BEFORE OPENING THE CASE. CONTACT WITH LIVE COMPONENTS WITHIN THE CHARGER COULD CAUSE ELECTRICAL SHOCK, SERIOUS INJURY, OR DEATH.**

This charger is designed to charge deep-cycle lead-acid batteries of wet/flooded, AGM (absorbed glass mat), or gel design. The charger is factory-configured to charge the type of battery indicated in the TYPE field on the charger ratings label (for example, "Wet"). Additionally, the charger includes a secondary battery profile available via an internal jumper on the control board. The last four (4) characters in the charger part number, available in the MODEL field on the charger ratings label, provide the battery profile codes for both the primary and secondary battery profiles. For example, charger part number 26070A01A1S1W1A1 has a primary battery profile code of "W1" and a secondary battery profile code of "A1". Figure 4-1 lists standard battery profile codes and their corresponding battery profiles. If a battery profile code for your charger is not listed in Figure 4-1, please contact your dealer regarding which battery profiles are available on your charger.

Part Number	Battery Profile Code	Battery Profile
	W1	Wet, standard
	A1	AGM, standard
	G1	Gel, standard

**Figure 4-1: Standard Battery Profile Codes and Their Corresponding Battery Profiles**

To change the active battery profile on your charger, remove the charger cover and position the jumper as shown in Figure 4-2. Profile 1 is the primary battery profile and the factory-configured jumper position. Profile 2 is the secondary battery profile. If changed from the factory-configured jumper position, Profile 1, mark the charger ratings label or add an additional label or tag.

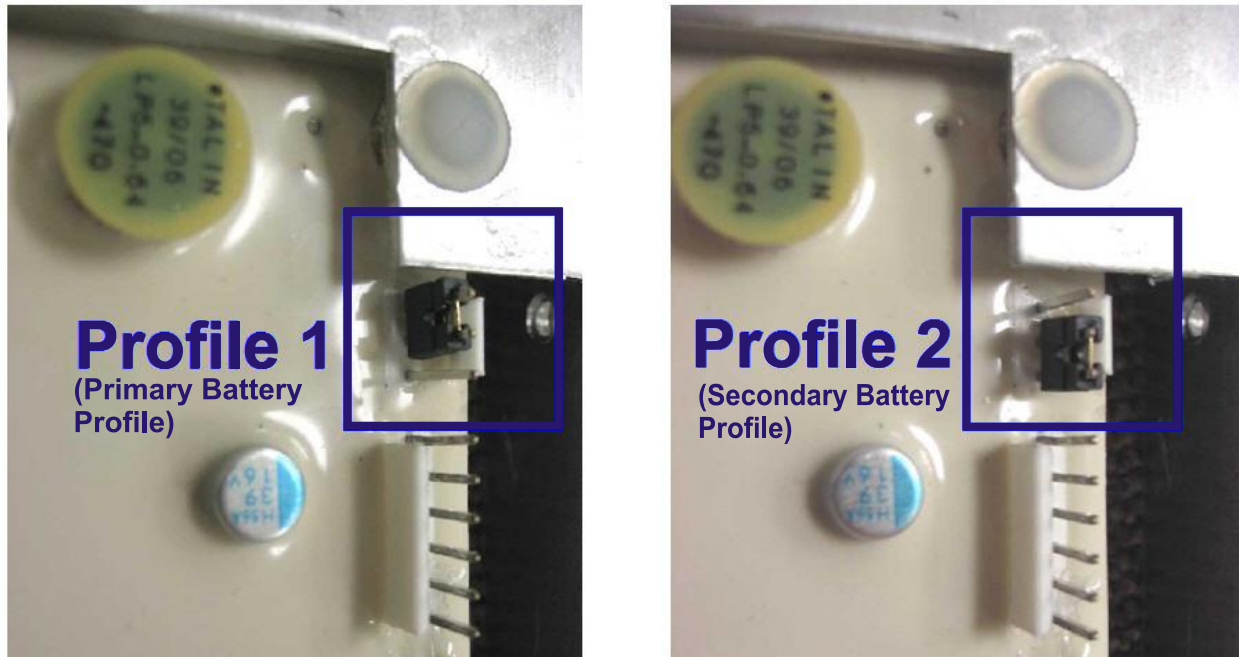

**Figure 4-2: Setting the Internal Battery Profile Jumper Determines the Battery Type**

**⚠ CAUTION: THIS CHARGER IS FOR USE ONLY ON RECHARGEABLE DEEP-CYCLE LEAD-ACID BATTERY SYSTEMS OF THE SAME TYPE AS THE SELECTED BATTERY PROFILE. BATTERIES IMPROPERLY MATCHED WITH THE CHARGER MAY BURST CAUSING PERSONAL INJURY AND DAMAGE TO BATTERIES OR CHARGER.**

Battery manufacturers frequently use the same battery cases for different battery types. Wet batteries have removable cell caps. Water electrolyzed by discharging and charging the battery is replaced through these openings. Sealed batteries are generally distinguished by non-removable cell caps. The physical appearance of the battery case is frequently the same as a wet battery, though the cell caps are generally not removable. Refer to the battery manufacturer's information panel on the battery case to determine the type battery you have. If the information panel is missing or not legible, do not use the battery.

## 5. OFF-BOARD (SHELF) CHARGING

This charger is configured for off-board charging. Off-board chargers are designed to be used in shelf or portable applications. They include rubber feet. If the AC input plug is connected to AC power, a new charge cycle automatically starts when the DC output is connected to a battery pack of the proper voltage. Disconnecting and reconnecting AC power while the DC output remains connected to a battery pack WILL NOT automatically start a new charge cycle (unless a storage mode condition has been met). Disconnecting the DC output from the battery pack IS REQUIRED to automatically start a new charge cycle.

---

## 6. LOCATION AND INSTALLATION

**⚠ WARNING: DO NOT INSTALL THE CHARGER ON OR NEAR FLAMMABLE MATERIALS. POSITION THE CHARGER ON A FOUNDATION OF STONE, BRICK, CONCRETE OR GROUNDED METAL.**

**⚠ WARNING: CHARGERS CAN IGNITE FLAMMABLE MATERIALS AND VAPORS. DO NOT USE NEAR FUELS, GRAIN DUST, SOLVENTS, THINNERS, OR OTHER FLAMMABLES.**

The charger may have been attached to a plywood board in the factory to protect it during shipping. If so remove the plywood shipping board before installation and operation of the charger.

Proper installation of the charger is important in order to achieve good performance and to prevent damage to the charger and batteries. The charger should be located in a clean, cool, dry, and well ventilated area. To permit free airflow for convection cooling, allow 2 inches (5.08 cm) minimum between the charger ventilation openings and any walls or other objects. Do not obstruct the airflow space around and beneath the charger. Do not allow clothing, blankets, or other materials to cover the charger.

Install the charger in an area where the temperatures will remain within the range of -4 °F to 113 °F (-20 °C to 45 °C) and the relative humidity will remain below 95 percent (%). Exceeding these ranges will reduce the current capacity and possibly the service life of the charger. If the charger will be operated outside of these ranges, contact your dealer to verify if it will withstand these conditions and perform at the needed capacity.

Do not operate the charger with a damaged AC or DC cable or connector. Do not operate the charger if it has received a sharp blow, was dropped, or was otherwise damaged in any manner. Contact your dealer.

**⚠ WARNING: REPLACE WORN, DAMAGED, OR CUT ELECTRICAL CORDS AND PLUGS IMMEDIATELY.**

**⚠ WARNING: KEEP DRY; DO NOT EXPOSE TO RAIN OR SPRAY. FOR STORAGE, KEEP CHARGER IN A BUILDING. NE PAS EXPOSER A LA PLUIE.**

## 7. AC INPUT

This charger must be connected to a single-phase nominal 120 Vac, 60 Hz AC power source with a voltage of 110 Vac to 132 Vac (charge times increase at lower AC voltages). The frequency must be 57 Hz to 63 Hz. Circuit breaker or fuse protection for the AC outlet to which the charger is connected should allow 15A per charger. Do not overload an electrical outlet.

This charger must be grounded to reduce the risk of electric shock. It is equipped with an AC cable with an equipment-grounding conductor and a grounding-type connector. The connector must be plugged into an appropriate outlet that is properly installed and grounded in accordance with the National Electrical Code and all local codes and ordinances.

**⚠ DANGER: IMPROPER CONNECTION OF THE GROUNDING CONDUCTOR CAN RESULT IN A RISK OF ELECTRIC SHOCK. DO NOT REMOVE GROUNDING PRONG FROM PLUG.**

The conductor with insulation having an outer surface that is green, with or without a yellow stripe(s), is the equipment-grounding conductor. If repair or replacement of the AC cable or connector is necessary, do not connect the equipment-grounding conductor to a live terminal. Contact your dealer. This charger is equipped with a grounding connector as illustrated in Figure 7-1 A, for use on a nominal 120 Vac, 60 Hz circuit. A temporary adapter, as illustrated in Figures 7-1 B and C, may be used to plug this connector into a two-pole receptacle as shown in Figure 7-1 C if a properly grounded outlet is not available (NOTE: use of an adapter as shown in Figures 7-1 B and C is NOT permitted in Canada). The temporary adapter should be used only until a properly grounded outlet can be installed by a qualified electrician. The green-colored rigid ear extending from the adapter must be connected to a permanent ground such as a properly grounded outlet box.

**⚠ DANGER: BEFORE USING THE ADAPTER AS ILLUSTRATED, BE CERTAIN THAT THE CENTER SCREW OF THE OUTLET PLATE IS GROUNDED.**



---

## GROUNDING METHODS

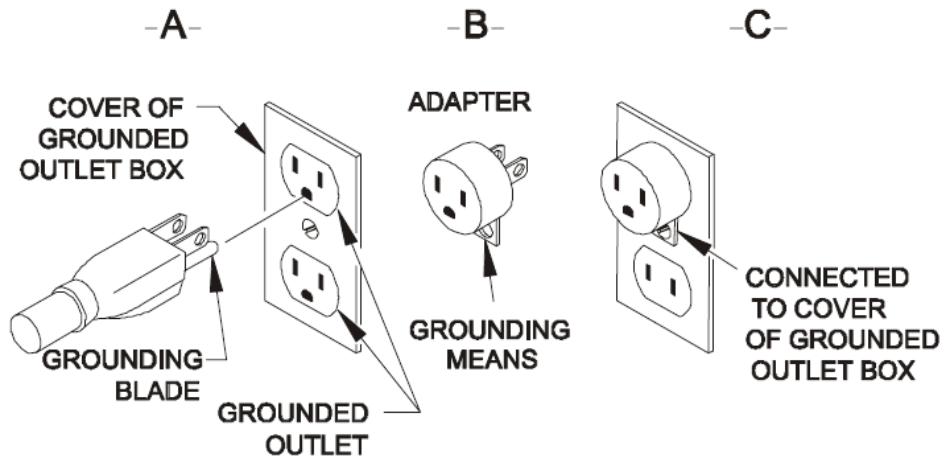

**Figure 7-1: Grounding Methods**

**(NOTE: Use of an adapter as shown in Figures B and C is NOT permitted in Canada)**

Use of an extension cord with the charger should be avoided. Use of an improper extension cord could result in a risk of a fire and electrical shock. If an extension cord is needed, use a three-conductor, No. 14 AWG (or larger) cord that is grounded, properly wired, and in good electrical condition, and keep the cord as short as possible. Make sure that the pins on the connector of the extension cord are the same number, size, and shape as those on the AC connector on the charger. Locate all extension cords so that they will not be stepped on, tripped over, or otherwise subjected to damage or stress.

The charger includes an AC input circuit breaker to protect the charger and the system.

### 8. DC OUTPUT

Only charge battery packs with cell counts (CELLS) and DC voltages (DC VOLTS) equal to those listed on the ratings label on the back of the charger.

The DC output cordset includes a commonly-used connector/plug. The polarity of the charger connector/plug must be the same as the battery connector/receptacle. The “-” marked (BLACK) DC cable must be connected to the battery negative (-), and the “+” marked (WHITE OR RED) DC cable must be connected to the battery positive (+). The charger will not operate if the polarity is reversed.

#### 8.1 ROUND MOLDED 3-PIN PLUG

If the DC cordset includes the round molded 3-pin plug for use with Club Car® vehicles, it is important to understand that this charger is intended for use with vehicles without an onboard computer (OBC). If the charger is connected to a vehicle with an onboard computer, the charger will not start a charge cycle.

In addition to the battery negative (-) and battery positive (+) pins, this plug includes a third pin. This third pin is connected to battery negative (-) inside the charger. It can be used with an optional external relay that can be installed in the vehicle to provide lockout/interlock functionality.

Club Car® is a registered trademark of Club Car Inc.

#### 8.2 DC OUTPUT FUSE

The DC output fuse is a fast-acting fuse used to protect the charger and the system.

**USE ONLY THE CORRECT SIZE IDENTICAL TYPE REPLACEMENT FUSES. FUSES ARE AVAILABLE FROM A QUALIFIED SERVICE TECHNICIAN.**

---

## 9. PROPER CARE OF DEEP-CYCLE MOTIVE POWER BATTERIES

Motive power battery packs are subjected to severe deep-cycle duty on a daily basis. Although these batteries are designed to withstand such duty, the following precautions must be observed to obtain good performance and maximum cycle life.

**⚠ CAUTION: ALWAYS WEAR PROTECTIVE EYE SHIELDS AND CLOTHING WHEN WORKING WITH BATTERIES. BATTERIES CONTAIN ACIDS WHICH CAN CAUSE BODILY HARM. DO NOT PUT WRENCHES OR OTHER METAL OBJECTS ACROSS THE BATTERY TERMINAL OR BATTERY TOP. ARCING OR EXPLOSION OF THE BATTERY CAN RESULT.**

1. When installing new batteries, be sure the polarity of each battery and the overall battery pack is correct. Otherwise, battery and/or charger damage can result.
2. New batteries should be given a full charge before their first use because it is difficult to know how long the batteries have been stored.
3. New batteries and older batteries that have been in storage are not capable of their rated output until they have been discharged and charged a number of times. Consult the manufacturer of your batteries for more information.
4. **DO NOT EXCESSIVELY DISCHARGE THE BATTERIES.** Excessive discharge can cause polarity reversal of individual cells resulting in complete failure shortly thereafter.
5. Maintain the proper electrolyte level of wet (flooded) batteries by adding water when necessary. Distilled or deionized water is best for battery life. Never allow the electrolyte level to fall below the top of the battery plates. Electrolyte levels lower during discharge and rise during charge. Therefore, to prevent the overflow of electrolyte when charging, it is mandatory that water be added to cells **AFTER** they have been fully charged – do not overfill. Old batteries require more frequent additions of water than new batteries.
6. Hard crystalline sulfates form when batteries in storage are not maintained in a charged active state. Internal self discharge can bring about the start of this condition in as little as three days in warm temperatures. Batteries not maintained and allowed to sit in storage will self discharge, sulfate and lose capacity. Repeated charging without using the batteries between charges can recover some of the lost power, range, and life, but some permanent loss should be expected.
7. Cold batteries require more time to fully charge. When the temperature falls below 65°F, the batteries should be placed on charge as soon after use as possible.
8. The tops of batteries and battery hold downs must be kept clean and dry at all times to prevent excessive self discharge and the flow of current between the battery posts and frame. Electrolyte spilled on batteries never dries or evaporates.
9. All connections to batteries must be maintained clean and tight. Due to heating and discharge rates, bolted connections loosen over time. Re-tighten the connections twice yearly to the torques specified by the battery manufacturers.
10. Follow all operating instructions, cautions, and warnings as specified in this manual, on the charger, in the battery manuals, and in the vehicle manuals.

### 9.1 Personal Safety Precautions

1. Have someone within the range of your voice and close enough to quickly come to your aid when you work near a lead-acid battery.
2. Ensure that ample fresh water and soap are nearby in case battery acid contacts your skin, clothing, or eyes.
3. Wear complete eye and clothing protection. Avoid touching your eyes while working near a battery.
4. If battery acid contacts your skin or clothing, wash immediately with soap and water. If acid enters your eye, immediately flush your eye with running cold water for at least 10 minutes, and get medical attention immediately.
5. **NEVER** smoke or allow a spark or flame to be in the vicinity of a battery.
6. Be extra cautious to reduce the risk of dropping a metal tool onto a battery. It could spark or short circuit the battery or other electrical components that could cause an explosion.
7. Remove personal metal items such as rings, bracelets, necklaces, and watches when working with a battery. A battery can produce a short-circuit current that is high enough to cause a severe burn.
8. **NEVER** charge a frozen battery.

---

## 10. CHARGER OPERATION

**⚠ WARNING: TO REDUCE THE RISK OF AN ELECTRIC SHOCK, CONNECT ONLY TO A SINGLE-PHASE, PROPERLY GROUNDED (3-WIRE) OUTLET. REFER TO GROUNDING INSTRUCTIONS.**

**⚠ CAUTION: MAKE SURE THE BATTERY IS A RECHARGEABLE DEEP-CYCLE BATTERY WITH THE PROPER RATED VOLTAGE FOR THIS CHARGER.**

**⚠ DANGER: TO PREVENT ELECTRICAL SHOCK, DO NOT TOUCH UNINSULATED PARTS OF THE CHARGER DC OUTPUT CONNECTOR, BATTERY CONNECTOR, OR BATTERY TERMINALS. MAKE SURE ALL ELECTRICAL CONNECTORS ARE IN GOOD WORKING CONDITION. DO NOT USE CONNECTORS THAT ARE CRACKED, CORRODED, OR DO NOT MAKE ADEQUATE ELECTRICAL CONTACT. USE OF A DAMAGED OR DEFECTIVE CONNECTOR MAY RESULT IN A RISK OF OVERHEATING OR ELECTRIC SHOCK.**

**⚠ WARNING: CHARGER IS NOT TO BE USED WHILE THE BATTERY POWERED EQUIPMENT IS OPERATING.**

**⚠ ATTENTION: *Ne pas utiliser le charger pendant que l'equipment est en marche.***

**⚠ WARNING: LEAD-ACID BATTERIES GENERATE GASES WHICH CAN BE EXPLOSIVE. TO PREVENT ARCING OR BURNING NEAR BATTERIES, DO NOT DISCONNECT THE CHARGER DC OUTPUT FROM THE BATTERIES WHEN THE CHARGER IS OPERATING. KEEP SPARKS, FLAME, AND SMOKING MATERIALS AWAY FROM BATTERIES.**

**⚠ WARNING: ALWAYS SHIELD EYES WHEN WORKING NEAR BATTERIES. DO NOT PUT WRENCHES OR OTHER METAL OBJECTS ACROSS BATTERY TERMINALS OR THE BATTERY TOP. ARCING OR EXPLOSION OF THE BATTERY CAN RESULT!**

**⚠ WARNING: DO NOT DISCONNECT THE CHARGER DC OUTPUT PLUG FROM THE BATTERY RECEPTACLE WHILE A CHARGE CYCLE IS IN PROGRESS. THE RESULTING ARCING AND BURNING OF THE PLUG AND RECEPTACLE COULD CAUSE THE BATTERIES TO EXPLODE.**

**⚠ CAUTION: TO AVOID DAMAGE TO THE CHARGER DC CABLE AND CONNECTOR AND BATTERY CONNECTOR, DISCONNECT BY GRASPING THE CHARGER CONNECTOR HANDLE OR BODY AND PULLING IT STRAIGHT OUT OF THE BATTERY CONNECTOR. DO NOT PULL ON THE CHARGER CABLE. DO NOT TWIST, ROCK, OR PULL THE CONNECTOR SIDEWAYS.**

**The instructions printed on the charger are for daily reference.**

1. With the charger DC output connector/plug disconnected from the vehicle charger receptacle, connect the AC input plug to a single-phase, 120V, 60 Hz AC outlet/receptacle (if not already connected).
2. Connect the charger DC output connector/plug to the vehicle charger receptacle. The charger will start automatically, which is indicated by the ammeter on the user interface displaying the output current. Monitor the ammeter for the correct output current. The initial output current could vary several amps from the start current listed in the specifications, depending on both the condition of the battery pack and its depth of discharge.

3. If the charger must be disconnected from a battery pack while a charge cycle is in progress, disconnect the charger AC input connector from the AC outlet to stop the charge cycle before disconnecting the DC output connector/plug from the vehicle charger receptacle. Do not disconnect the DC output connector/plug from the vehicle charger receptacle while a charge cycle is in progress. The resulting arcing and burning of the contacts could cause the battery to explode.
4. The charger automatically terminates the charge cycle when a battery pack reaches full charge. The necessary charge time is affected by numerous factors. The major factors affecting the required charge time are the amp-hour capacity, depth of discharge, temperature, and age/usage of the battery pack.
5. After a charge cycle has completed, disconnect the charger DC output connector/plug from the vehicle charger receptacle.
6. If the charger DC output connector/plug remains connected to the vehicle charger receptacle after the charger automatically terminates the charge cycle and the charger has AC power available, it will enter a storage mode where it periodically performs a maintenance charge cycle. (Storage mode is a feature of specific charge/battery profiles. Contact your dealer to determine if your charger includes a storage mode.)

### 10.1 User Interface

The user interface (Figure 10.1-1) includes an ammeter for monitoring the DC output current of the charger. The user interface also includes an AC input circuit breaker and DC output fuse.



Figure 10.1-1: User Interface

---

## 11. MAINTENANCE

**⚠ WARNING: DISCONNECT BOTH AC AND DC POWER FROM THE CHARGER BEFORE PERFORMING ANY MAINTENANCE. CONTACT WITH LIVE COMPONENTS WITHIN THE CHARGER COULD CAUSE ELECTRICAL SHOCK, SERIOUS INJURY, OR DEATH.**

**⚠ CAUTION: KEEP CHARGER CLEAN AND DRY, INSIDE AND OUT. FAILURE TO DO SO MAY CAUSE DAMAGE OR FAILURE OF CHARGER.**

The charger requires minimal maintenance. It should be kept clean. Twice a year, or as often as the cleanliness of the area may dictate, the interior of the charger should be thoroughly blown clean with dry compressed air. The components of the charger are cooled by natural convection. If dust and debris are allowed to build up, they will restrict airflow and could cause components to overheat. Always be careful not to bump wiring or components. This could cause loose connections and failures.

Moisture may cause electrical shorting and/or corrosion. It may also combine with dust and debris making them more difficult to remove. Do not use liquids to clean the charger. Liquids could cause damage. Compressed air should be used to clean dust and debris from the charger and its components.

### 11.1 Check Charger Area

The area around the charger must remain clean, cool, dry, and well ventilated. Check for obstructions to airflow, clearances, or other violations of the requirements in Section 5.

### 11.2 Visual Inspections

Check the charger for any physical failures, such as loose contacts or hardware, excess wear, or damage. Darkened or hot terminals should be tightened or replaced.

### 11.3 Battery Conditions

**⚠ CAUTION: CHECK THE DC CONNECTIONS FROM THE CHARGER TO THE BATTERY AND MAKE SURE THEY ARE TIGHT AND CLEAN. TIGHTEN AND/OR CLEAN IF NEEDED. FAILURE TO DO SO COULD CAUSE MALFUNCTION, FIRE, OR EXPLOSION.**

Batteries must be well maintained for the charging system to operate properly. Follow battery manufacturer instructions for battery maintenance. Check for loose connections or corrosion.

DC connections may become corroded over time. If the connections become corroded, they should be cleaned as recommended by the battery manufacturer. After the connections have been cleaned, a battery connection treatment should be applied to help prevent corrosion from reoccurring. Contact the battery manufacturer for their recommendations.

Periodic cleaning and watering of non-sealed batteries is very important. Logging the water usage of non-sealed batteries is useful. As a battery ages, it will use more water.

## 12. TROUBLESHOOTING AND SERVICE

**⚠ CAUTION: DO NOT DISASSEMBLE THE CHARGER. TAKE IT TO A QUALIFIED SERVICE TECHNICIAN WHEN SERVICE OR REPAIR IS REQUIRED. INCORRECT REASSEMBLY MAY RESULT IN A RISK OF ELECTRIC SHOCK OR FIRE.**

**⚠ DANGER: TO REDUCE THE RISK OF ELECTRIC SHOCK, ALWAYS DISCONNECT BOTH THE POWER SUPPLY CORD AND THE OUTPUT CORD BEFORE ATTEMPTING ANY MAINTENANCE OR SERVICE.**

**⚠ WARNING: DO NOT OPERATE THE CHARGER IF IT IS MALFUNCTIONING. PERSONAL INJURY OR PROPERTY DAMAGE COULD RESULT.**

The charger was fully tested and calibrated before leaving the factory. It was delivered ready to charge. If properly installed, the charger should require very little attention. If improper charger operation occurs, it will require repair by a qualified service technician.

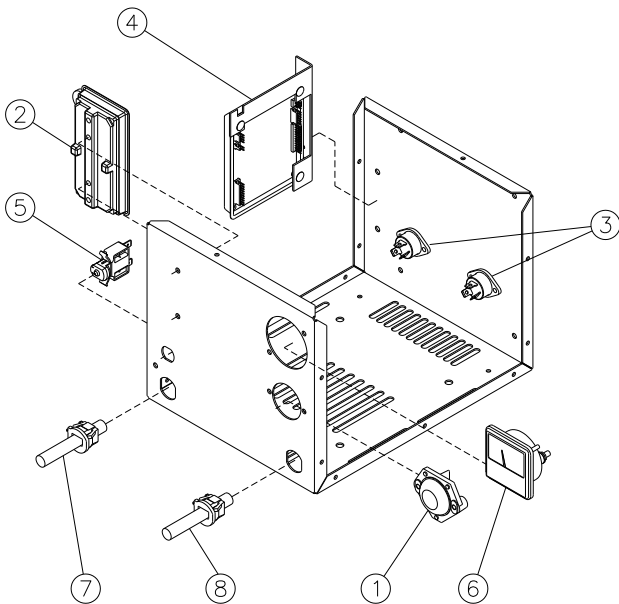

MODEL #25970, 25940, & 26070

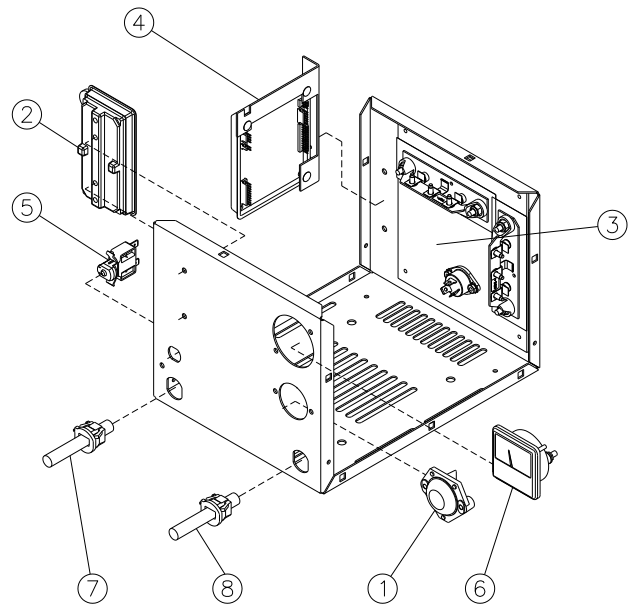

MODEL #27730 ONLY

**SERVICE PARTS LIST**

#	Service Part Description	25970 36V 21A	25940 36V 25A	26070 48V 17A	27730 48V 13A
1	Fuse Assembly	08776S	08776S	08776S	08776S
2	Relay Board Assembly	27105-11S	27105-11S	27105-12S	27105-12S
3	SCR Assembly Kit	37204S	37204S	37204S	38729S
4	Control Board Assembly	27075-00S	27075-00S	27075-00S	27075-00S
5	AC Circuit Breaker	34882S	34882S	34882S	31847S
6	Ammeter	21461S	16369S	16895S	16895S
7	AC Cordset Kit	21307-08S	13072-08S	21307-08S	21307-08S
8	DC Cordset Kit	Contact Your Sales Representative			
N/A	Misc Wiring Kit (Control Cables)	37447S	37447S	37447S	39309S
N/A	Case assembly	37327S	37327S	37327S	39042S

# WIRING DIAGRAM

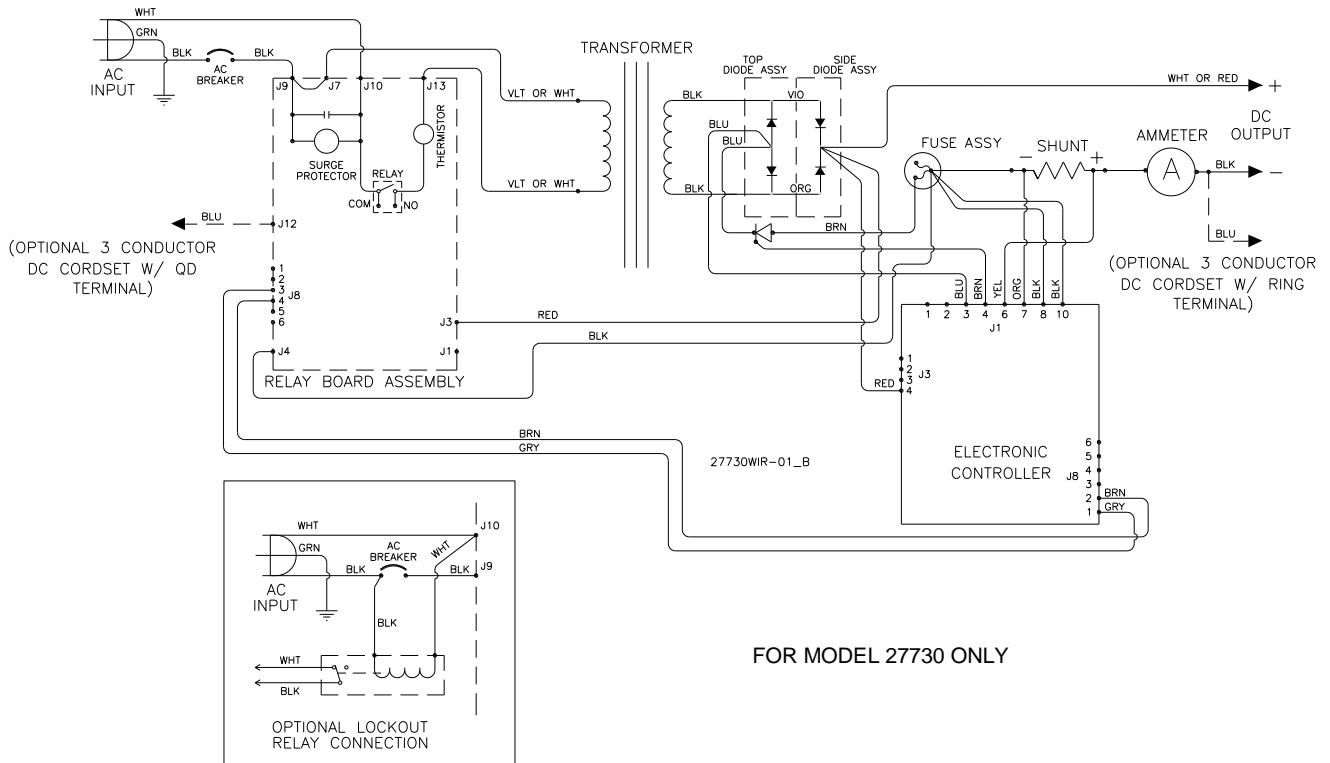
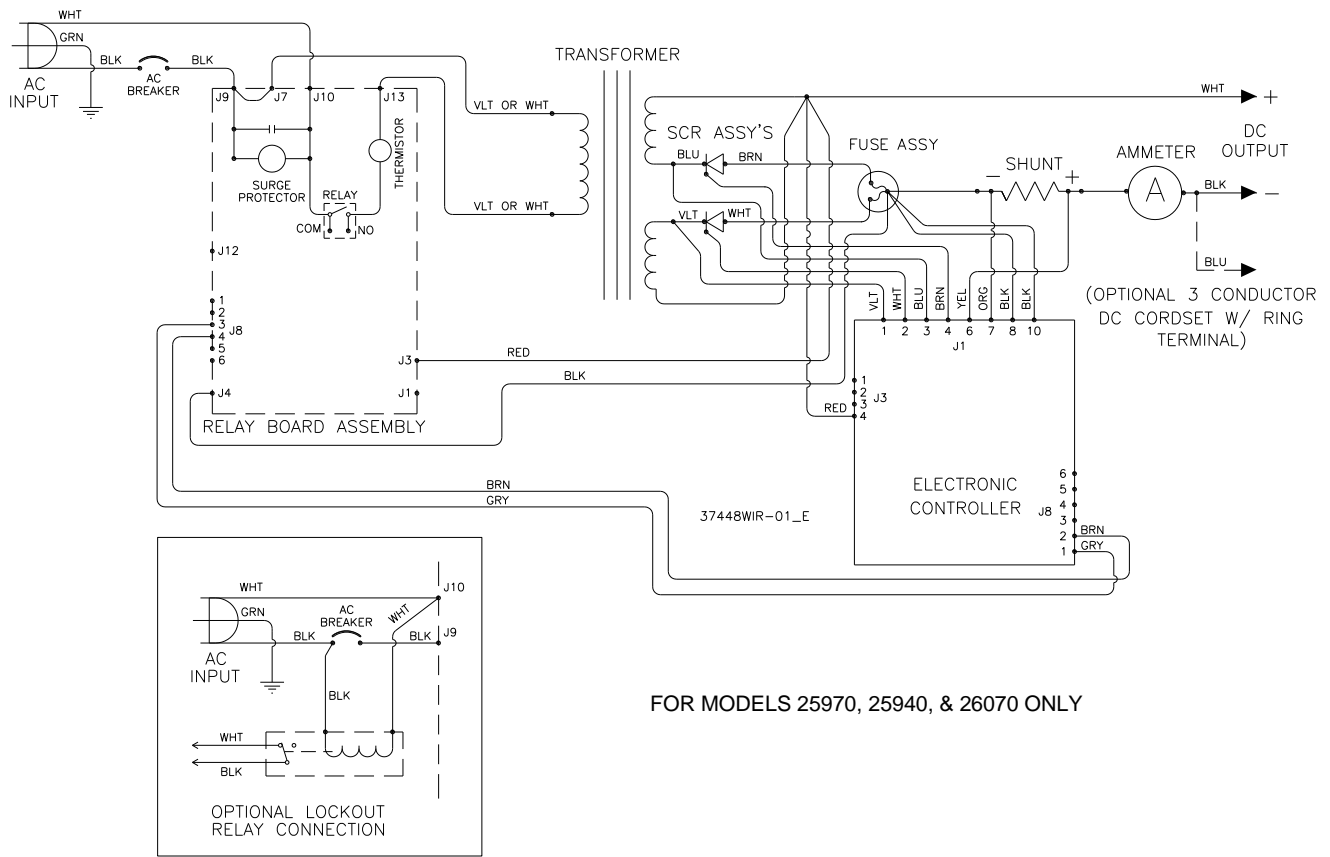

---

## NOTES

Represented By:

