



OMNTEC

Advanced Tank Monitoring & Leak Detection



1. Open the camera app
2. Focus the camera on the QR code by gently tapping the code
3. Follow the instructions on the screen to view PDF file

LU2-LF-HL

INSTALLATION GUIDE

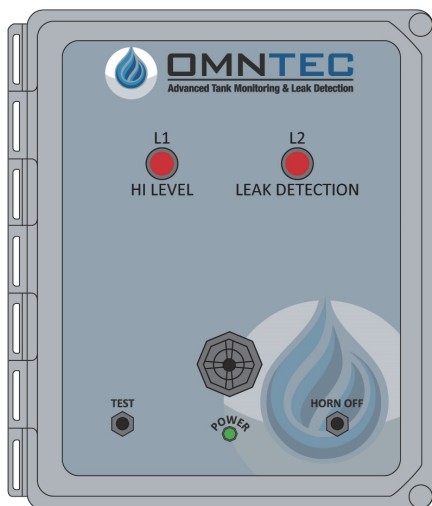

TWO CHANNEL ALARM PANEL

Revision 2314

Document No. LU2-LF-HL rev2314

TABLE OF CONTENTS

LU2-LF-HL SPECIFICATIONS.....	3
DIMENSIONS FOR MOUNTING AND KNOCKOUTS.....	4
LU2-LF-HL CONTROLLER CONNECTION DIAGRAM.....	5
LS-ASC SENSOR.....	6
LWF SENSOR.....	7
LF-SERIES SENSOR.....	8
RA-SERIES REMOTE HIGH-LEVEL ALARM.....	10
LOG SHEET.....	11
WARRANTY.....	12

LU2-LF-HL

TWO CHANNEL ALARM PANEL

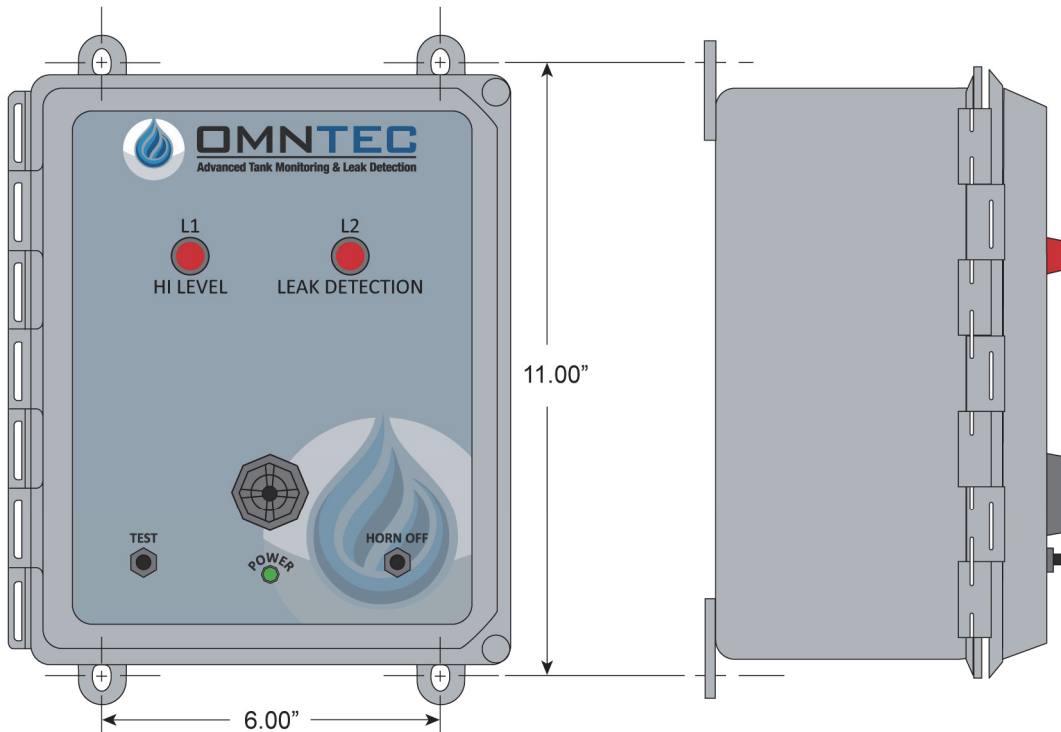

LU2-LF-HL SPECIFICATIONS

POWER INPUT

100-240 VAC, 47-440 Hz
16 Watts maximum

POWER TO SENSORS

13.80 VDC @ 13 ma

RELAY OUTPUT

SPST normally open dry contacts 0.5 AMPS, 120 AC/DC switches when an alarm condition occurs

WEIGHT

6 LBS.

DIMENSIONS

(W) 9" x (H) 10.5"

SENSOR CABLE

Shielded 22 AWG UL-E118830 CM
Maximum length 2000 feet

ENCLOSURE

NEMA 4X

OPERATING TEMPERATURE

-40° to 140° F

AUDIO/VISUAL CONSOLE

AUDIBLE ALARM - 95 dB pulsing horn with 30 second timeout

RED LIGHT - Indicates liquid alarm for LF-Series float sensor

TEST BUTTON - When pressed will test system electronics

GREEN LIGHT - Indicates the power is on

HORN OFF BUTTON - Silences the audible alarm when pressed

SENSORS

LF Series Single-point liquid float sensor; normally closed

LS-ASC Non distinguishing liquid optic sensor

LWF Non distinguishing liquid optic sensor for fiberglass tank dry interstitial

OPTIONAL ACCESSORIES

RA-1 Audio/visual remote annunciator

RLY-RA-1 Relay

LABELS

Provided with controller



OMNTEC

Advanced Tank Monitoring & Leak Detection

LU2-LF-HL

DIMENSIONS FOR MOUNTING AND KNOCKOUTS

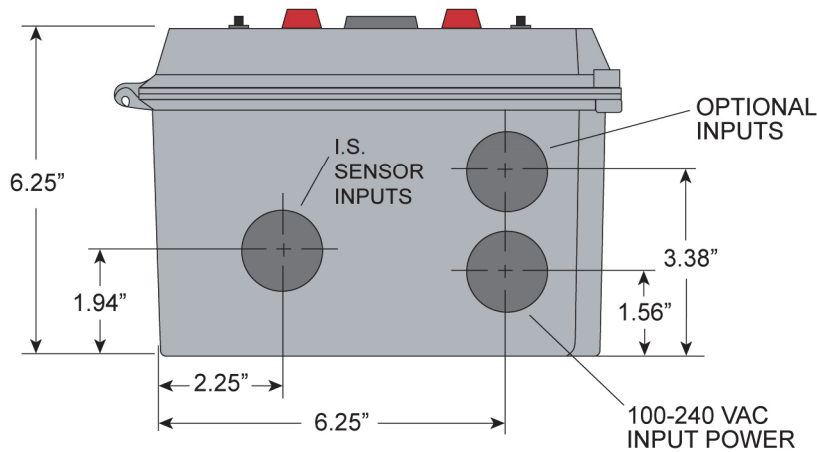
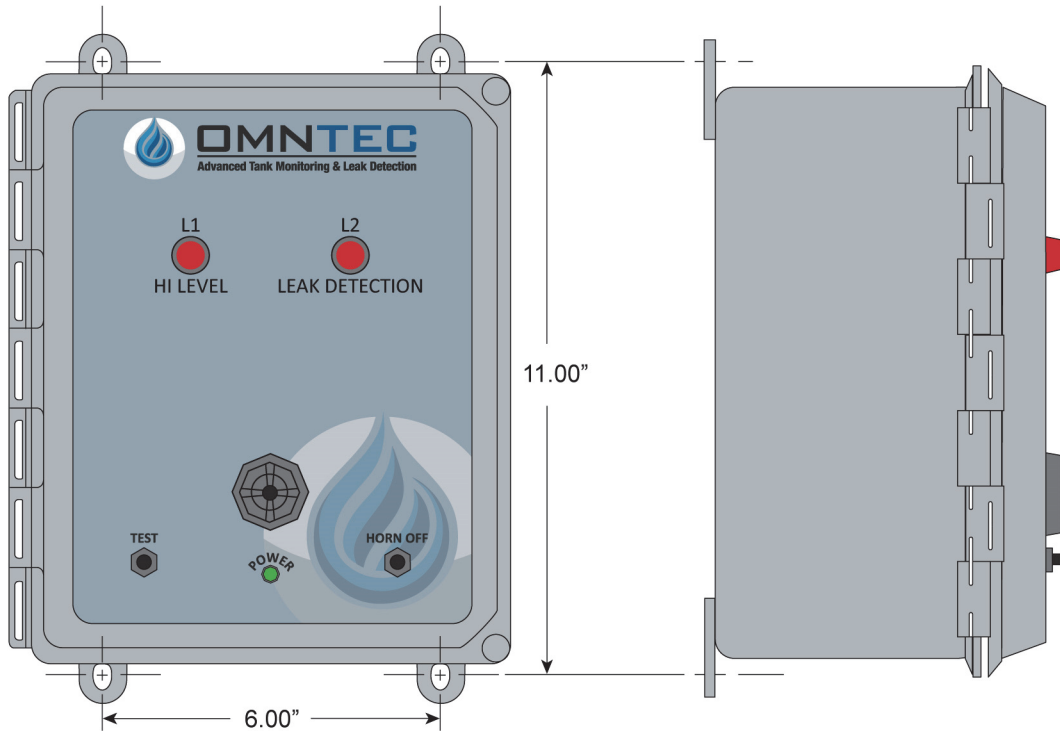

LU2-LF-HL CONTROLLER CONNECTION DIAGRAM

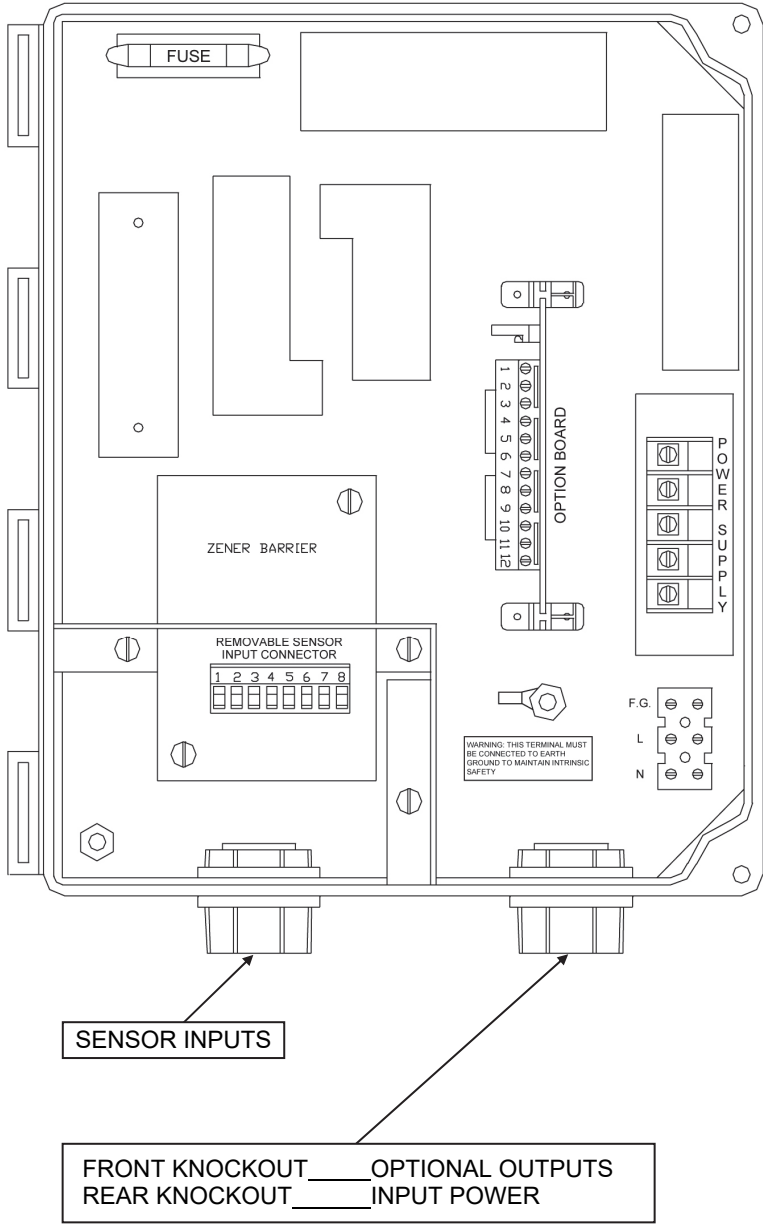

COLOR CODE

CABLES FROM SENSORS TO REMOVABLE SENSOR INPUT CONNECTORS

1	UNUSED	SENSOR #1 LF-1 HI LEVEL
2	RED	SENSOR #2 LEAK
3	RED	
4	WHITE	
5	UNUSED	
6	UNUSED	
7	BLACK	FROM SENSOR #1 & #2
8	SHIELD DRAIN	

WIRES TO OPTION BOARD

WIRES FROM RA-SERIES REMOTE

1	GREEN	- HORN
2	RED	+ HORN
3	BLACK	GROUND
4	WHITE	SENSOR #1 HI LEVEL
5	ORANGE	SENSOR #2 LEAK
6	UNUSED	

WIRES FROM RELAY OUTPUTS

7	UNUSED	
8	UNUSED	
9	COMMON	SENSOR #2 LEAK
10	NORMALLY OPEN	
11	COMMON	SENSOR #1 HI LEVEL
12	NORMALLY OPEN	

120 VAC

WIRES TO POWER SUPPLY

F.G.	FIELD GROUND
L	LINE
N	NEUTRAL

NOTE: To maintain proper shielding, BLACK sensor wires and SHIELD DRAINS should **not** be connected together at sensors.

LS-ASC SENSOR

NON-PRODUCT DISTINGUISHING OPTIC SENSOR

PRINCIPLES OF OPERATION

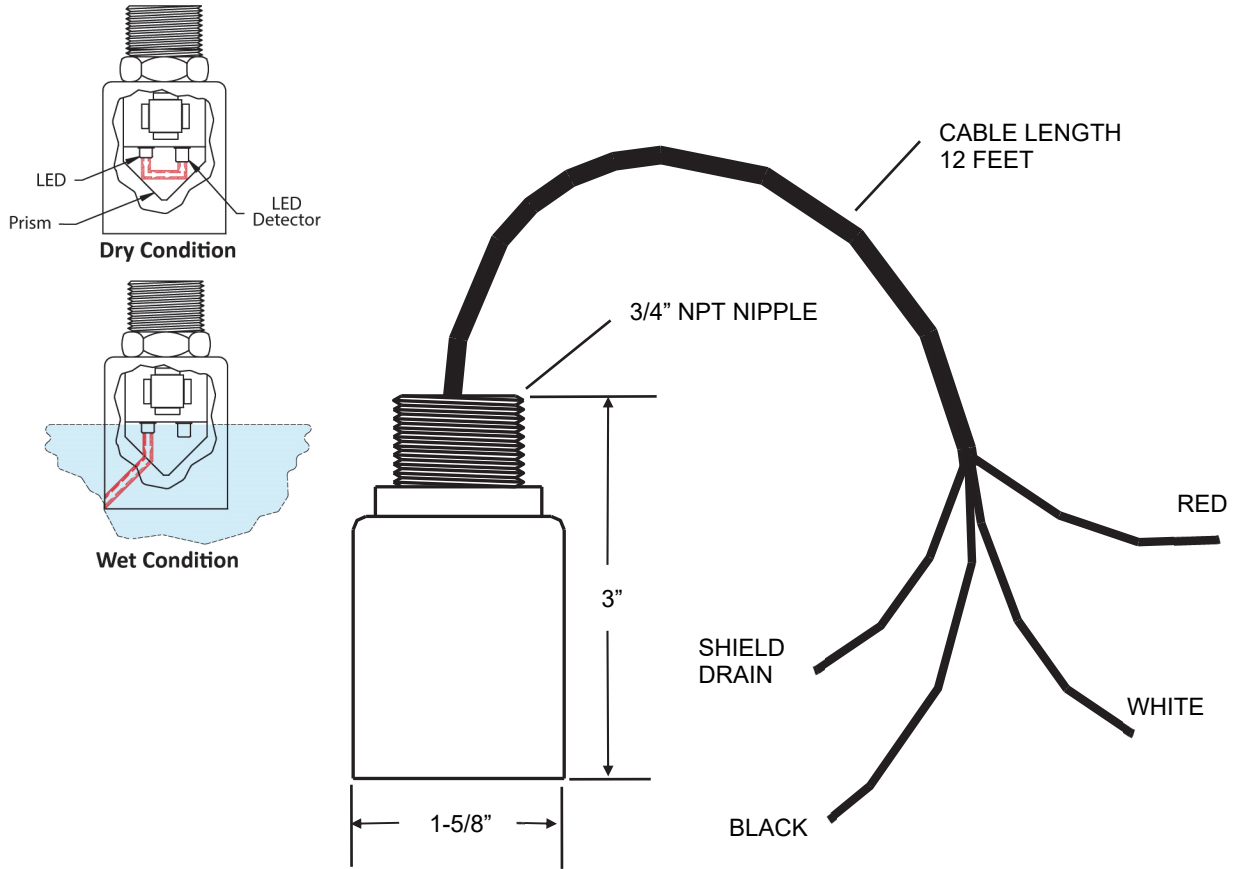

LS-ASC SPECIFICATIONS

U.L. LISTED 5L04

Intrinsically safe Class I, Group D Hazardous Locations when connected in accordance with control drawing nos. L1, L2, L3, L4, L6, L9

OPERATING TEMPERATURE

-40 TO +140 F

POWER

2 VDC @ 13 mA

WEIGHT

1/2 pound

PRINCIPLES OF OPERATION

LIQUIDS (ex: fuel, water) – Photo optic
 DRY CONDITION – Normally closed light beam
 ALARM CONDITION – Opens (refracts) normally closed light beam

SENSOR CABLE

Shielded 22 AWG UL-E118830 CM
 Maximum length 2000 feet

RESPONSE TIME

Immediate



OMNTEC

Advanced Tank Monitoring & Leak Detection

LWF SENSOR

NON-PRODUCT DISTINGUISHING FIBERGLASS TANK DRY INTERSTITIAL SENSOR

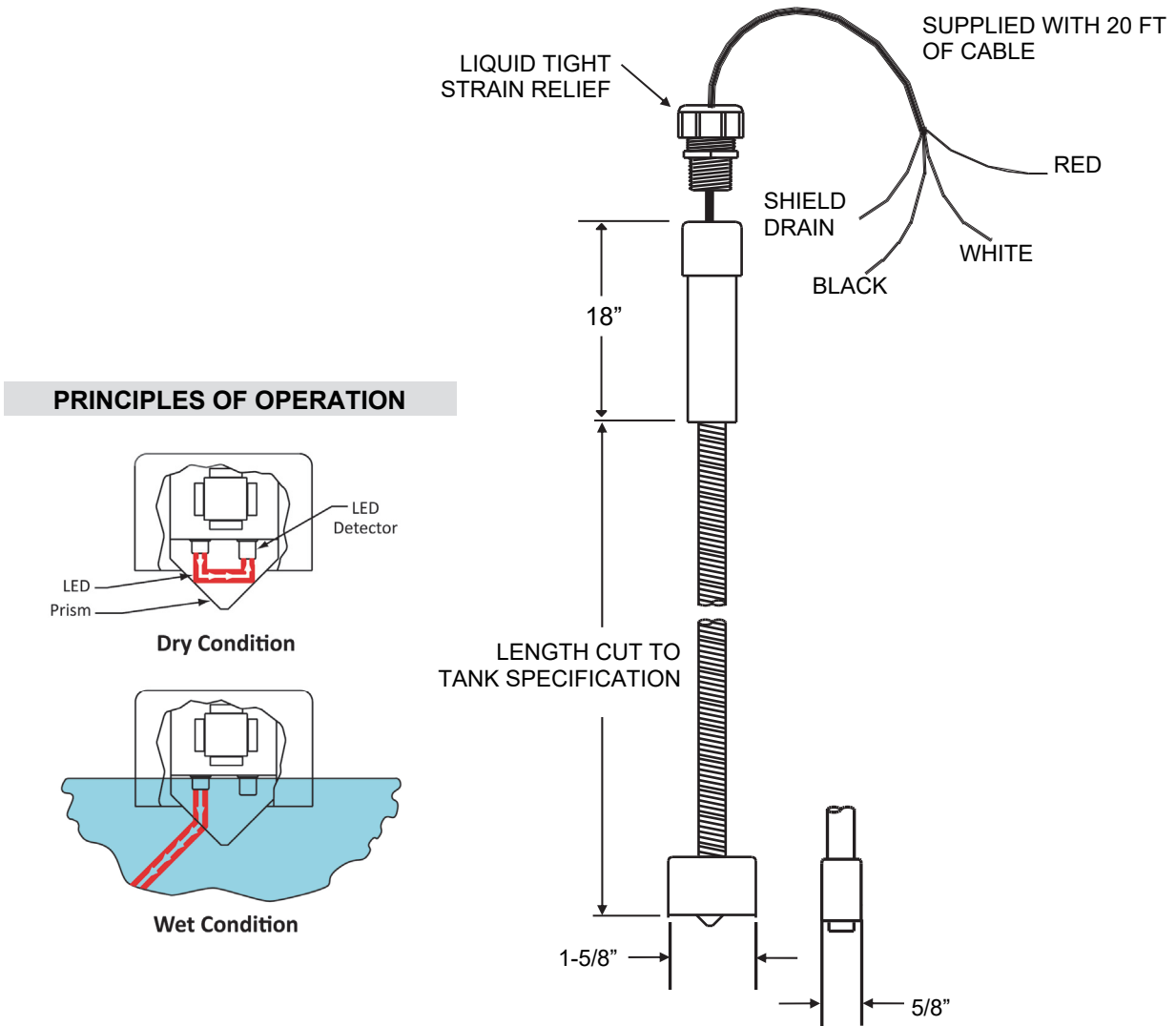

PRINCIPLES OF OPERATION

LWF SPECIFICATIONS

OPERATING TEMPERATURE

-40 TO +140 F

PRINCIPLES OF OPERATION

LIQUIDS (ex: fuel, water) – Photo optic
 DRY CONDITION – Normally closed light beam
 ALARM CONDITION – Opens (refracts) normally closed light beam

POWER

2 VDC @ 13 mA

SENSOR CABLE

Shielded 22 AWG UL-E118830 CM
 Maximum length 2000 feet

WEIGHT

2 pounds

RESPONSE TIME

Immediate

LF-SERIES SENSOR

LIQUID LEVEL FLOAT SENSORS

- Stainless Steel or Brass Mountings
- 1 to 6 Actuation Levels
- Lengths to over 11 feet
- U.L. Recognized, CSA Listed

LF series float sensors have multiple options including material of construction, mountings and float sizes. This allows for the LF sensor to be extremely versatile in a wide range of applications such as water, oils, chemicals and corrosive liquid.

LF-* switches are U.L. Approved for Class I, Division 2, Groups A, B, C, D hazardous locations. FM Approved explosion proof junction box must be installed for Class I, Division I, Group D hazardous locations.



Specifications		
	BUNA N	Stainless Steel
Operating Temperature	Water: to 180 F Oil: -40 F to +230 F	40 F to +300 F
Stem & Mounting Material	Brass	316 Stainless Steel
Max Length (Lo)	120" (305 cm)	
Float Stops*	Beryllium Copper	316 Stainless Steel
Compatible Controllers	Consult factory	
Approvals	U.L. Recognized, CSA Listed	

Specifications subject to change without notice, verify with manufacturer.

Group 1
Switch (N.O. or N.C.):
SPST: 50 VA

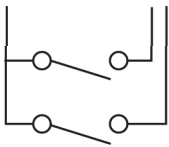

Group 2
Switch (N.O. or N.C.):
SPST: 50 VA

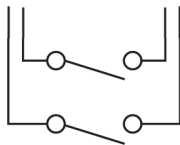

- For clarity, only two actuation levels are shown in each group diagram.
- Standard setup is Group 2 unless otherwise specified.

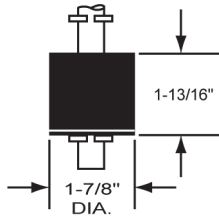

BUNA N Float

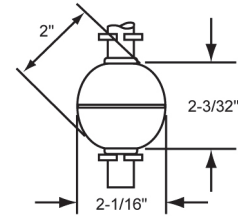

Stainless Steel Float

Consult factory for materials other than stainless steel and BUNA N.

LF-SERIES SENSOR

Switch actuation levels are determined following the guidelines below:

All units 72" or less overall unit length with Stainless Steel or Buna N floats.

A = 1-1/2" (38.1mm) minimum distance to highest level (2" (50.8mm), Type 5 only)

B = 2" (50.8mm) minimum distance from end of unit to lowest level

C = 3" (76.2mm) minimum distance between levels

D = 1/4" (6.3mm) minimum distance between actuation levels (Note: One float for two levels can be used only when low level is N.C. dry and high level is N.O. dry)

* Actuation level distances and L₀ (overall unit length) are measured from inner surfaces of mounting plug or flange

** Length Overall L₀ = L₁ + Dimension B. See mounting Types for Maximum Length values

Notes:

1. A, B and C dimensions based on a liquid specific gravity of 1.0
2. One float for two levels can be used only when 20VA switch is used
3. Actuation levels are calibrated on descending fluid level, with water as the calibrating fluid, unless otherwise specified
4. Tolerance on actuation levels is +/- 1/8" (3.2mm)

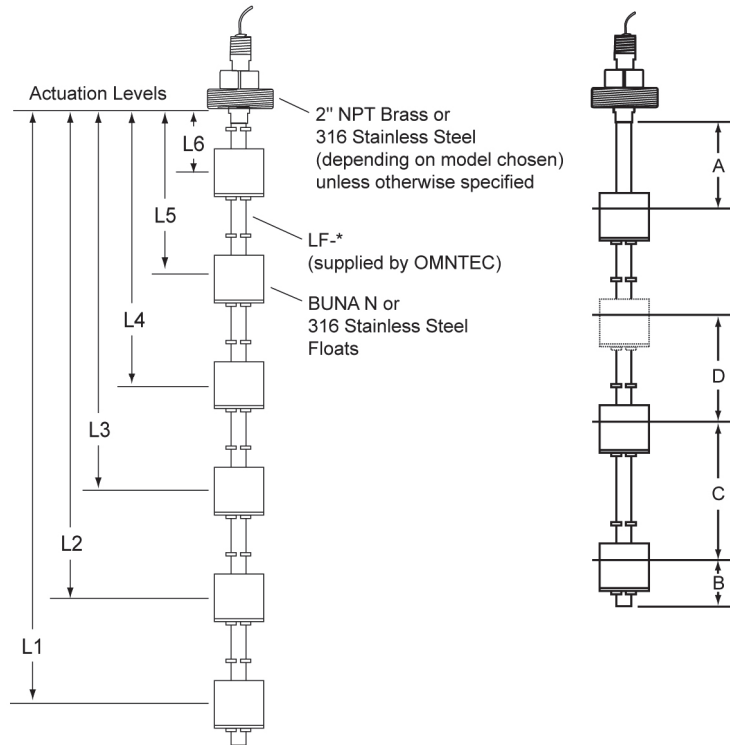

Optional Alternative Mounting for 1/2" NPT

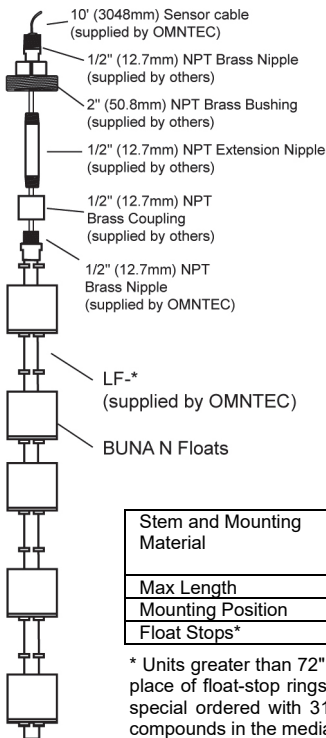

Wiring Color Code					
Wiring	Level 1	Level 2	Level 3	Level 4	Level 5
LF-1	black/red	-----	-----	-----	-----
LF-2	black/red	green/white	-----	-----	-----
LF-3	white/red	blue/green	black /orange	-----	-----
LF-4	black/red	green/white	blue/orange	yellow/brown	-----
LF-5	black/red	green/white	blue/orange	yellow/brown	purple/grey

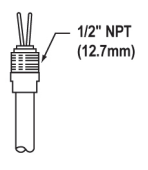
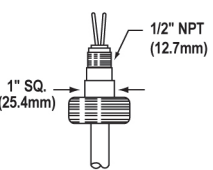
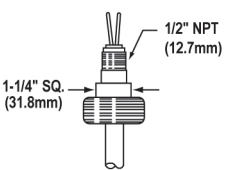
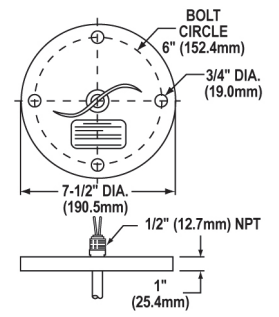
	Type 1 1/2" (12.7mm) NPT	Type 2 1-1/4" (31.8mm) NPT	Type 3 2" (50.8mm) NPT	Type 4 3" (76.2mm), 150# Dia. Flange
				
Stem and Mounting Material	Brass or 316 Stainless Steel			Flange: Carbon Steel or 316 S.S. Stem: 316 S.S.
Max Length	36" (91.4 cm)	60" (152.4 cm)	140" (355.6 cm)	
Mounting Position	Vertical 30 Inclinaton			
Float Stops*	Brass Units: Beryllium Copper Grip Rings, Stainless Steel Units: S.S. ARMCO PH-15-7MO Grip Rings			

* Units greater than 72" (1828mm) overall length are supplied with collars with setscrews (made of same material as stem and mounting) in place of float-stop rings. Collars are optional on units less than 72" (1828mm) overall length. Units requiring 316 SS float stops must be special ordered with 316 SS collars instead of grip rings. In some instances, the use of concentration of chlorine and other corrosive compounds in the media require the use of collar type float stops. Consult factory for details.

RA-SERIES REMOTE HIGH-LEVEL ALARM

RA-1



RA-2

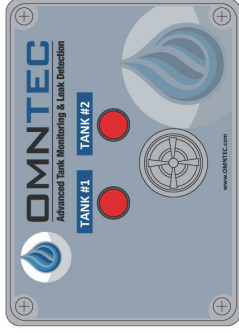

RA-3



RA-4



INTERNAL WIRING COLOR CODE

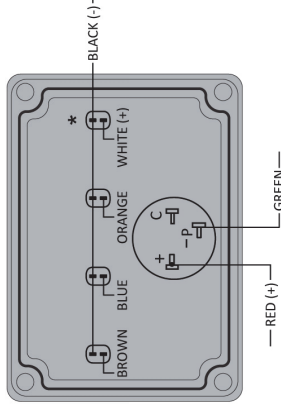
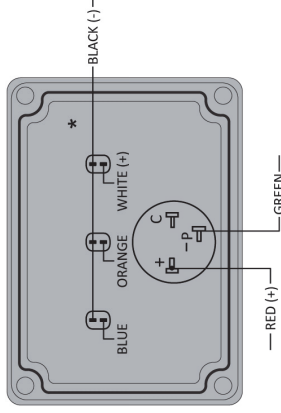
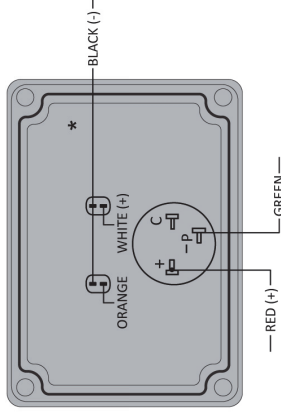
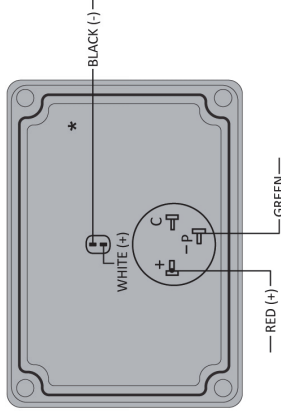

*Warning Label Placed Here

WARNING: LOW VOLTAGE INPUTS ONLY

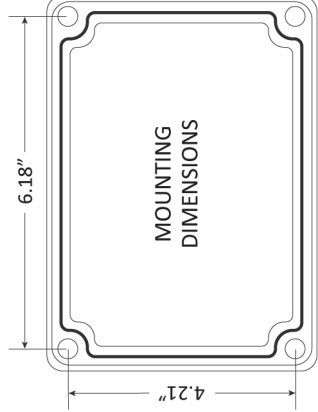
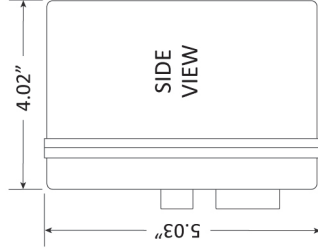

SPECIFICATIONS

Audible Alarm	95 dB pulsing horn
Red Light	Liquid-high-level alarm
Response Time	Immediate
Power Input	12VDC @200mA maximum from controller
Wire	22 AWG minimum
Weight	1 lb.

Note: It is recommended that knockouts be placed in the bottom of enclosure.

WARRANTY

The seller OMNTEC Mfg., Inc. warrants to buyer defects when properly installed, and maintained by user. The seller's sole obligation is to repair or replace parts found to be defective, or non-conforming for one year and only after evaluation by factory. The liability of the seller shall not exceed the price paid for the components found to be defective. The above warranty is exclusive of all other warranties whether implied or expressed. Seller assumes no obligation for special or, indirect damages incurred by user.

All standard tank gauging systems are free of defects when properly installed and maintained by user. Warranty on tank gauging systems will only be effective after proper documentation has been submitted by the buyer to OMNTEC Mfg., Inc. The seller's sole obligation is to repair or replace parts found to be defective, or non-conforming for one year and only after evaluation by factory. Technical support must be contacted for a Return Material Authorization (RMA #) prior to sending any potentially defective parts. The liability of the seller shall not exceed the price paid for the components found to be defective. The above warranty is exclusive of all other warranties whether implied or expressed. Seller assumes no obligation for special or indirect damages incurred by user.

All standard replacement parts, "add-ons", or spare parts are free of defects when properly installed and maintained by user. The seller's sole obligation is to repair or replace parts found to be defective or non-conforming for 90 days and only after evaluation by factory. The liability of the seller shall not exceed the price paid for the components found to be defective. The above warranty is exclusive of all other warranties whether implied or expressed. Seller assumes no obligation for special or indirect damages incurred by user.

Equipment not covered by this warranty includes but is not limited to: custom equipment and control systems.