

LEVER VALVES / VALVOLE COMANDO A LEVA

VALVE / VALVOLA 3/2

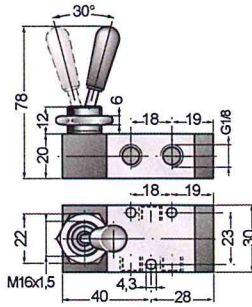

PORT CONNECTION G1/8 - LEVER VALVE
CONNESSIONI G1/8 - COMANDO MANUALE A LEVA

VCML32..8

VCML32018



VCML326M8

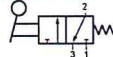

VCML329M8

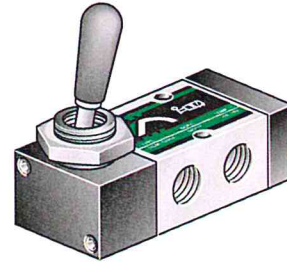
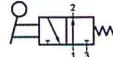

Available with rubber bellow protection
Disponibile con soffiello di protezione

VALVE / VALVOLA 5/2 - 5/3

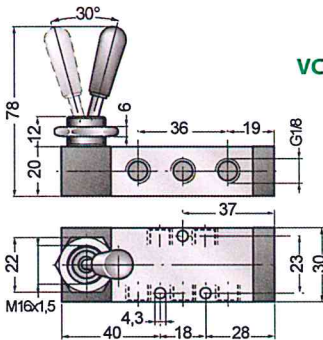
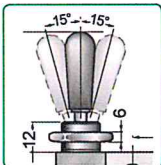

VCML52018



VCML52M18



VCML53618

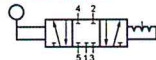

VCML536M8



VCML53918



VCML539M8

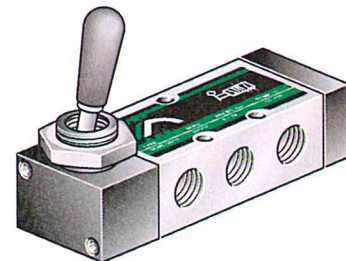

Available with rubber bellow protection
Disponibile con soffiello di protezione

VALVE / VALVOLA 3/2

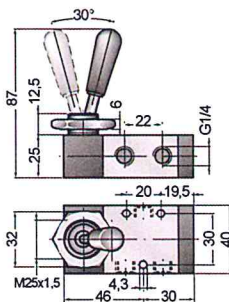

PORT CONNECTION G1/4 - LEVER VALVE
CONNESSIONI G1/4 - COMANDO MANUALE A LEVA

VCML32..4

VCML32014



VCML326M4

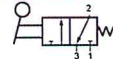

VCML329M4

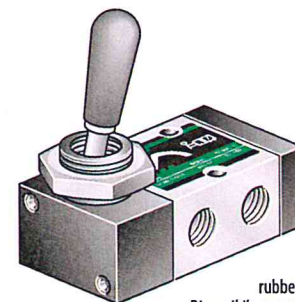
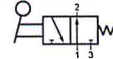

Available with
rubber bellow protection
Disponibile con soffiello di protezione

VALVE / VALVOLA 5/2 - 5/3

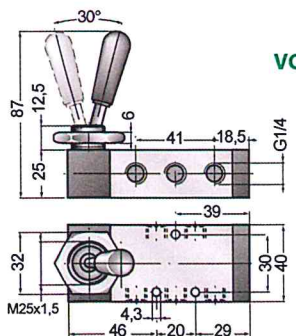
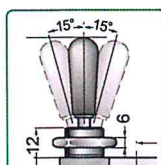

VCML52014



VCML52M14



VCML53614

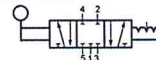

VCML536M4

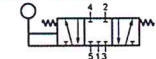

VCML53914

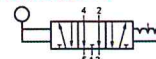

VCML539M4

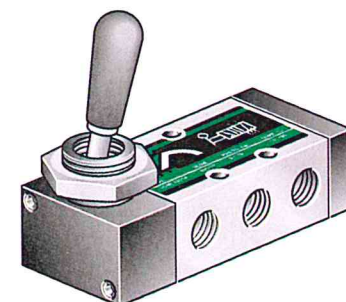

Available with rubber bellow protection
Disponibile con soffiello di protezione