



**Electra Steam, Inc.**

4407 Martinsburg Pike  
Clear Brook, VA 22624  
USA

Phone: 540-662-3811  
Fax: 540-665-8101  
email: [Sales@reimersinc.com](mailto:Sales@reimersinc.com)  
web: [www.reimersinc.com](http://www.reimersinc.com)

MODEL:

SERIAL #:

---

## RHP600 – RHP750 High Pressure Steam Boiler Models

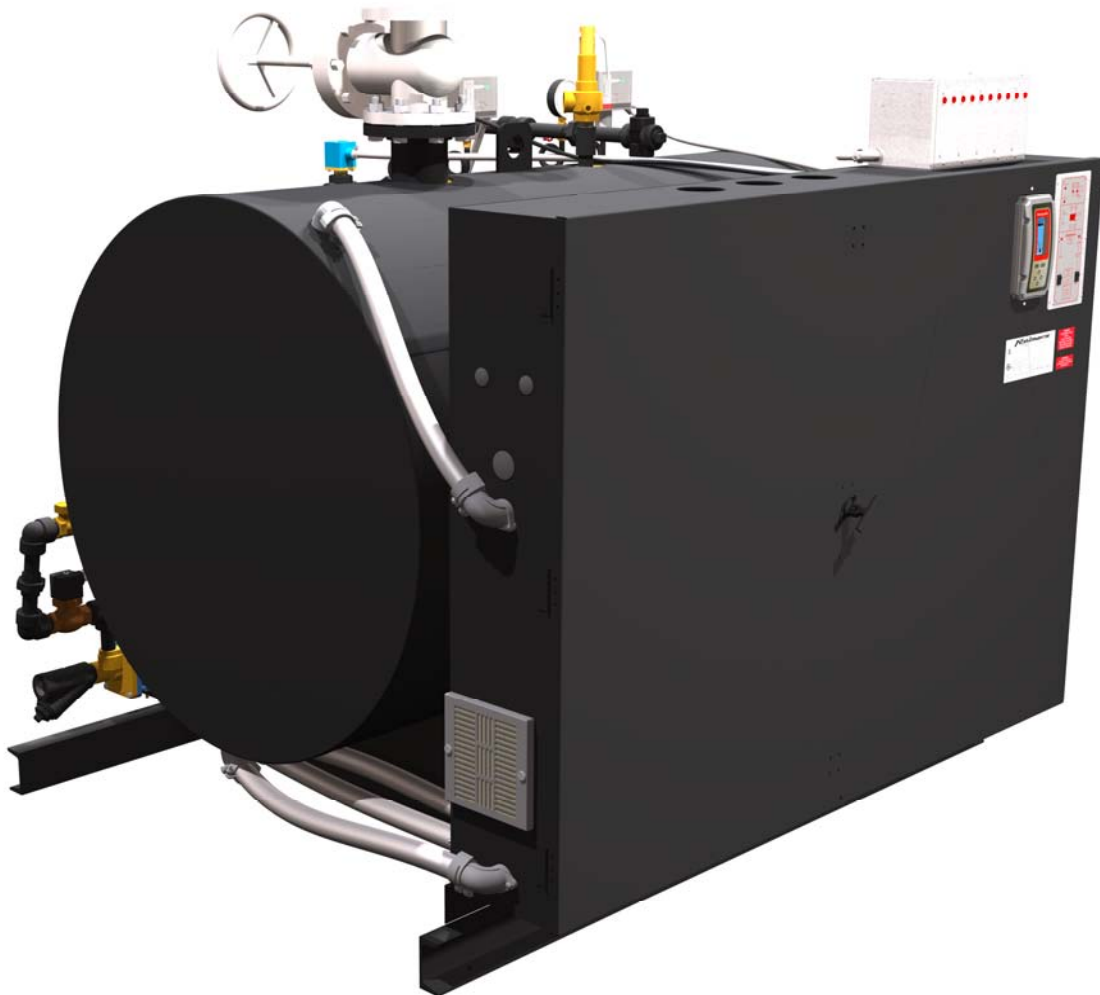

## Instructions Manual

---



# READ AND HEED FOR YOUR SAFETY

## SHOCK AND BURN WARNINGS RHP120 – RHP300 HIGH PRESSURE STEAM BOILER MODELS



You have just purchased a quality steam boiler designed to the ASME Boiler Code and registered with the National Board of Boiler Inspectors. Treat this industrial equipment with care and respect. It is safe when installed, maintained, and used properly. Read the instruction carefully, refer to the enclosed identification photos and contact the factory if you have any questions.

### 1.) ADJUSTMENTS:

All controls have been set at the factory and should require no adjustments. However, the boiler must be level.

### 2.) BLOWDOWN VALVE:

This valve is utilized to blow impurities from the boiler chamber. When opened, a large volume of hot water and steam is discharged. Ensure that this valve is properly piped for such discharge. State and local codes must be met as applicable.

### 3.) ELECTRICAL:

All wiring must be in accordance with the National Electric Code and any local codes that may apply. Wiring must be made by a competent certified electrician. Use copper wire only.

### 4.) GAUGE GLASS:

The gauge glass protector must be installed at all times. When replacing glass be sure that the unit is not under pressure and is cool to touch. To do otherwise could cause scalding. Gauge glasses should be replaced annually due to internal wear. **HOT!** The valves and piping on this unit are hot when under pressure or heating up. Don't touch!

If a leak is evident: Steam fittings can become loose during shipment and subsequently leak. Leaks through the gauge glass packing nuts occur more frequent than on other pipe fittings. It is easy to resolve these leaks if you are careful:

1. Ensure that the boiler is cold, drained and has no pressure or electricity.
2. Tighten leaking packing nut gently a quarter of a turn. Do not over tighten, as this will result in gauge glass breakage or in valve failure.
3. Fill boiler and operate normally.
4. Observe for more leaks and repeat steps 1 and 2 as required.



### 5.) INSTRUCTIONS:

Read instructions before installing or operating this steam boiler. These are provided as general guidelines.

### 6.) MODIFICATION/MISUSE:

This boiler has been designed and constructed in accordance with the ASME Boiler Code. Any modification or misuse can result in a dangerous situation. Reimers Electra Steam, Inc. is not liable for any product that has been modified or improperly used.

**7.) PRESSURE GAUGE:** The pressure gauge indicates the internal pressure of the boiler. It can fail. Periodically have your boiler inspector compare the gauge with a known gauge utilizing the test valve arrangement provided. Ensure that the boiler is cold, not pressurized and electrically disconnected.

### 8.) REGISTRATION:

Most states and cities require boiler registration and inspection. Check with your government authorities.

### 9.) REPAIR:

Repair of this unit must be attempted only by experienced personnel. Before commencing a repair, ensure that the boiler is cold, not pressurized and electrically disconnected. All standard electrical and steam safety precautions must be taken during testing.

### 10.) SAFETY VALVE:

The safety valve is designed to discharge hot steam when the set pressure is exceeded. Ensure that the discharge port is pointing toward the back of the unit away from the operator or any aisles. Test the safety valve periodically to ensure that it is operating properly. Test carefully at full pressure by lifting lever using pliers and "slapping" shut. Steam discharge can scald. Ensure no one is exposed!

### 11.) STEAM INSTALLATION:

Steam piping must be black pipe, not galvanized. Work must be done by an experienced steam fitter. All state and local codes must be met as applicable.

### 12.) WATER:

Ensure that all electrical components are in a dry location, free from any possibility of water soaking.

## **Limited Warranty - Steam Boilers**

Reimers Electra Steam, Inc. warrants the following products of its own manufacture against defects in materials and workmanship under normal use and service. This warranty is in lieu and excludes all other expressed or implied warranties or merchantability of fitness for any particular use. No person is authorized to extend the terms of this warranty or assume any other liability except by written statement signed by an officer of Reimers Electra Steam, Inc. Clear Brook, Virginia 22624.

### **Warranty Period:**

The pressure vessel and electrical & mechanical components are warranted for one year from date of shipment from Reimers Electra Steam, Inc. in Clear Brook, VA 22624.

### **Limitations:**

Products must be installed, used and maintained in accordance with our instructions, including reasonable & necessary maintenance by the user. Users are responsible for the suitability of the products to their application. There is no warranty damage resulting from improper installation, abuse, power failure, fire, flood, lightning, improper water, misuse, improper specification, misapplication or other operating conditions beyond our control or parts that are normally expendable in usual course of operation.

Claims against carriers for damage in transit must be filed by the buyer. Reimers liability, if any, will not exceed the price of Reimers products claimed to be defective.

Components manufactured by any supplier other than Reimers shall bear only that warranty made by the manufacturer of that product and service for that warranty shall be the responsibility of that manufacturer and not Reimers.

### **Remedy:**

Claims under this Limited Warranty must be made by obtaining a Return Authorization Number from our office (PHONE: 540-662-3811, FAX: 540-665-8101) & returning defective part, freight prepaid to: Reimers Electra Steam, Inc., 4407 Martinsburg Pike, Clear Brook, Virginia 22624

Defective items will be repaired or replaced as necessary within a reasonable time without charge, other than incidental charges such as freight prepayment. Such repair or replacement within a reasonable time is the exclusive remedy available from Reimers Electra Steam, Inc., under this Limited Warranty.

### **Consequential Damages:**

Reimers Electra Steam, Inc., is not liable for labor costs incurred in the removal, reinstallation, or unauthorized repair of product, or for damages of any type whatsoever, including incidental and/or consequential damages.

**This Warranty supersedes all previous warranties.**

# 1. Installation

REIMERS ELECTRA STEAM, INC. boilers are heated by one or more immersion type heating elements. Automatic controls are provided to maintain pre-set operating pressure and proper water supply. Safety features include automatic low water cutoff, automatic pressure control, safety valve and visible water level gauge. Each boiler is manufactured in accordance with the ASME Power Boiler Code Standards and is individually inspected and stamped by an authorized National Board Insurance Inspector. All boilers are registered with the National Board of Boiler and Pressure Vessel Inspectors. When boiler is received, make sure it has not been damaged in shipment.

**NOTE:**

**ASME DATA PLATE IS LOCATED ON END OF PRESSURE VESSEL BEHIND LABEL STAMPED WITH NATIONAL BOARD NUMBER OF UNIT.**

## 1.1 Location

Place the boiler in a level position, close to the equipment which it is to supply. This will insure minimum heat losses and allow more economical piping arrangements. All steam lines should be insulated. Review the overall dimensions of your boiler model on page 6 to select proper boiler location.

Regardless of the NFPA-70 working space requirements shown below, provide a minimum of 3ft clearance on both sides of the boiler for element servicing, 3ft of clearance to the front of the boiler and 1.5ft to the rear of the boiler.

a.) Working space:

Electric boiler spacing is dictated by NFPA-70, Table 110.26 as follows:

Nominal Voltage To Ground (Volts)	Minimum Clear Distance		
	Condition 1	Condition 2	Condition 3
0 – 150	3ft (914mm)	3ft (914mm)	3ft (914mm)
151 – 600	3ft (914mm)	3.5ft (1.07m)	4ft (1.22m)

Note: Where the conditions are as follows:

**Condition 1** — Exposed live parts on one side of the working space and no live or grounded parts on the other side of the working space, or exposed live parts on both sides of the working space that are effectively guarded by insulating materials.

**Condition 2** — Exposed live parts on one side of the working space and grounded parts on the other side of the working space. Concrete, brick, or tile walls shall be considered as grounded.

**Condition 3** — Exposed live parts on both sides of the working space.

(a) *Dead-Front Assemblies.* Working space shall not be required in the back or sides of assemblies, such as dead-front switchboards or motor control centers, where all connections and all renewable or adjustable parts, such as fuses or switches, are accessible from locations other than the back or sides. Where rear access is required to work on non-electrical parts on the back of enclosed equipment, a minimum horizontal working space of 762 mm (30 in.) shall be provided.

**b.) Alcove or closet installation per UL834:** Proper location of this boiler model with regard to combustible and noncombustible surfaces and materials is coded on the boiler name plate. The following decoding sketch and description is provided for the user information:

RHP-, RHPH- and RHPHC- Models	Dimension In.						
	A	B	D	EL	ER	F	G
	24	A6	6	6	6	C	-

Description of dimensions and symbols

**A** – Clearance above top of boiler

**B** – Clearance from front of boiler

**Prefix C** to numeral indicates suitability for closet or alcove installation

**Prefix A** indicates suitability for alcove but not for closet installation

**D** – Clearance from back of boiler

**EL** – Clearance from left side of boiler

**ER** – Clearance from right side of boiler

**F** – Indicates type of flooring: "**NC**" for noncombustible floor / "**C**" for combustible floor. Numeral indicates minimum clearance below suspended units to combustible floor

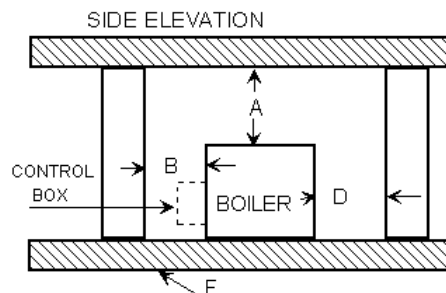
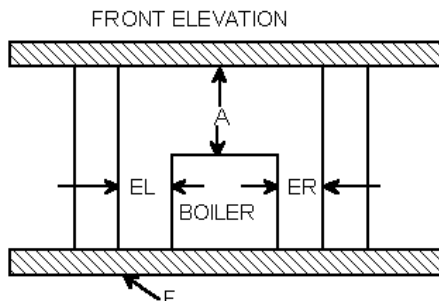

**RHP & RHPH600 – RHP750 Overall Dimensions (approximate)**

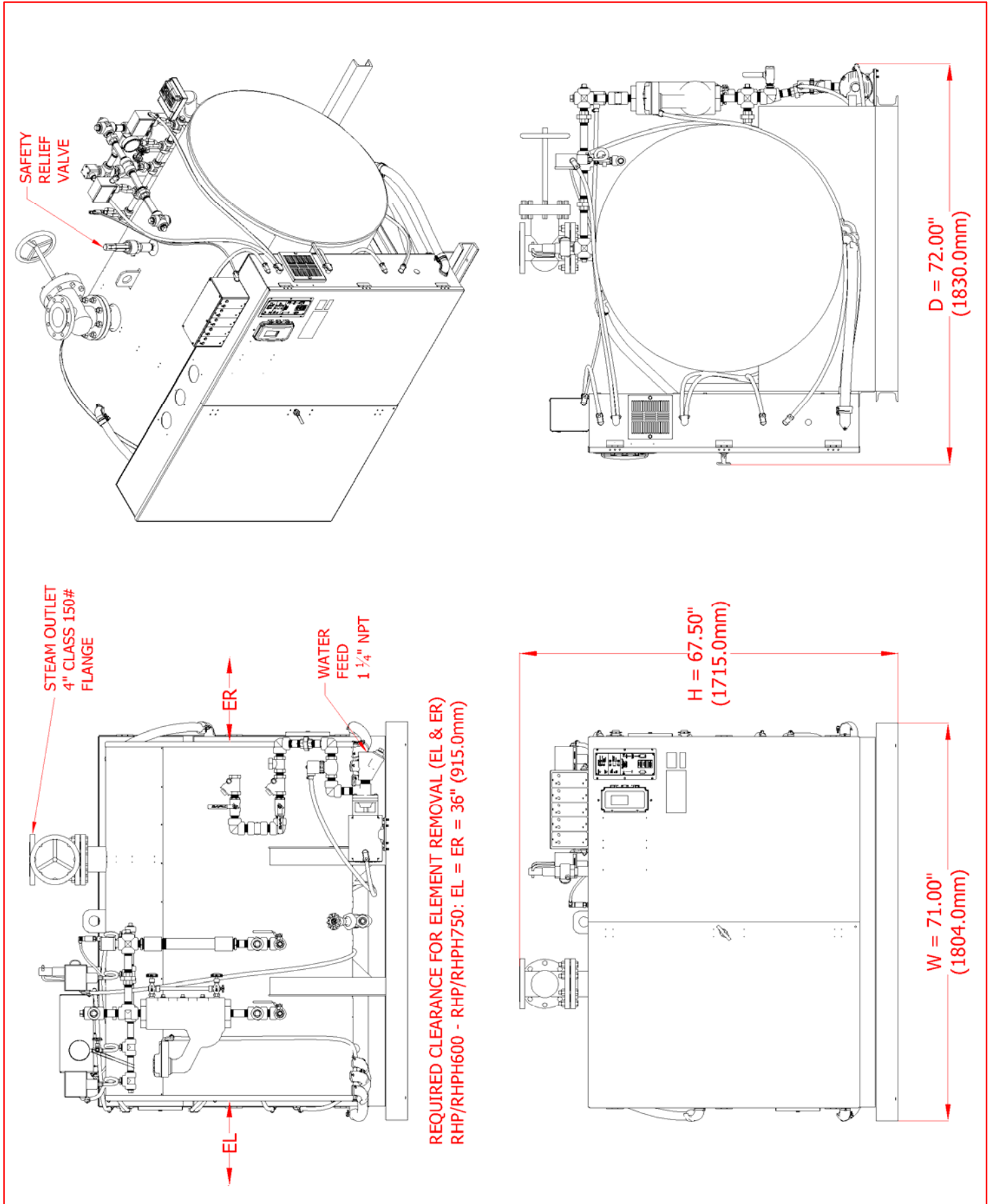

**RPHC600 – RHP750 Overall Dimensions (approximate)**

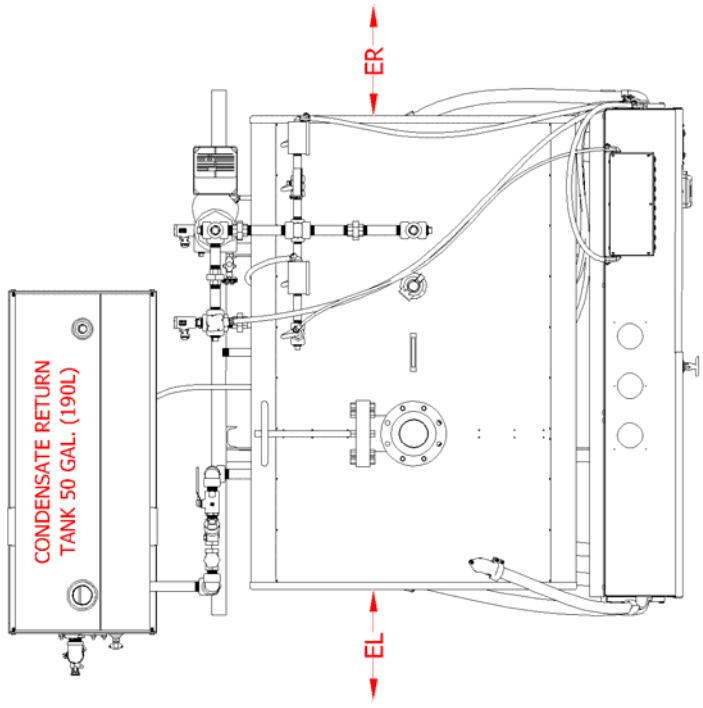

REQUIRED CLEARANCE FOR ELEMENT REMOVAL (EL & ER)  
 RHPHC600 - RHPHC750: EL = ER = 36" (915.0mm)

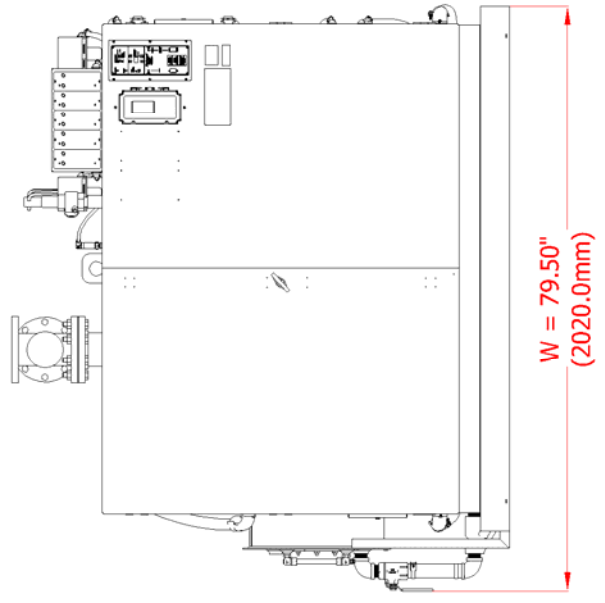

SAFETY RELIEF VALVE

STEAM OUTLET 4" CLASS 150# FLANGE

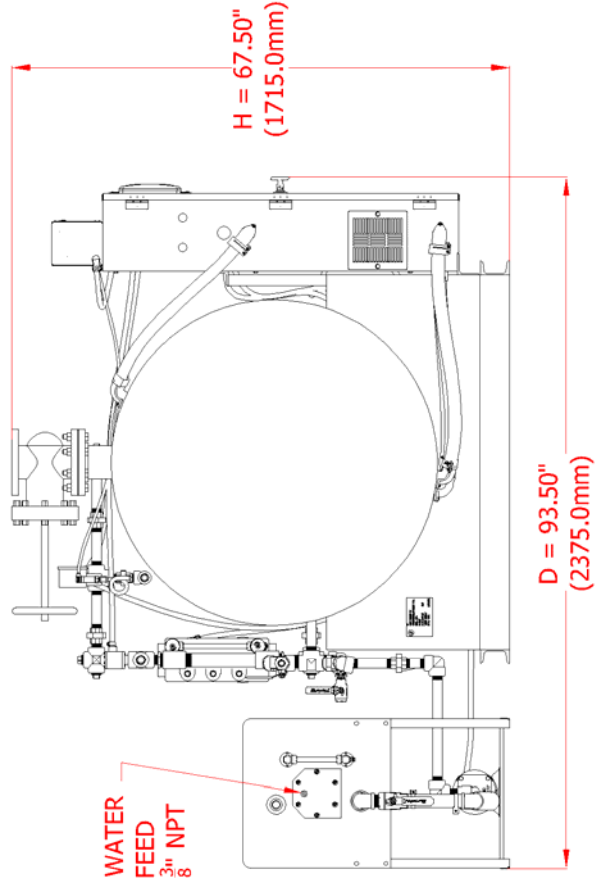
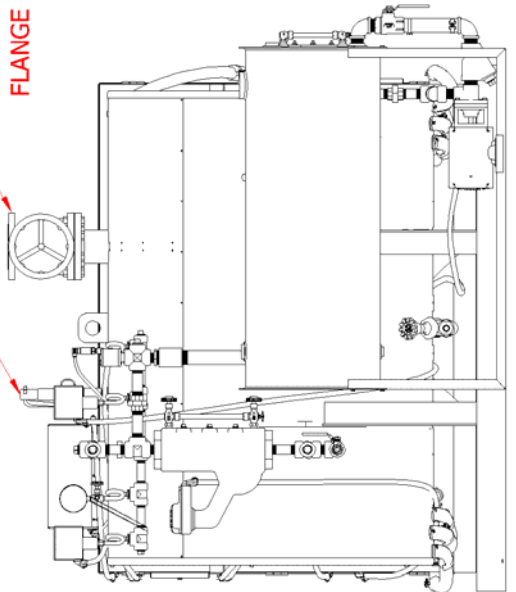

## 1.2 Water Supply

On models with pump and solenoid valve, connect incoming water supply to strainer on intake side of pump. On models furnished with condensate return tank, connect water line to makeup valve located at tank end. RHP steam boiler models require four (4) gallons of feed water per hour for each 10 kW of electric heating capacity of the boiler. Lines should be of adequate size and meet local plumbing codes.

In order to ensure long term trouble-free boiler operation, we recommend that the water used as boiler feed water to be tested for hardness. If the water in your area is harder than 1grain (17mg/L), use a water softener. The main cause for premature heating element failure in electric steam boilers is water hardness. If severe corrosion during inspection of the pressure vessel as indicated in chapter 3.4 of this manual becomes evident, additional tests of your boiler feed water must be performed. A water analysis should be performed by a qualified and recognized water treatment company located in your area.

Recommended levels for boiler feed water:

WATER PROPERTY	MAX. LIMIT
Total hardness	17 mg/L
Dissolved Oxygen	0.04 mg/L
Total Iron	0.1 mg/L
Total Copper	0.05 mg/L
pH	> 8.5
Specific Resistivity	25kΩ * cm

Recommended levels for boiler water (water inside pressure vessel when boiler operating)

PROPERTIES	MAX. LIMIT
Total Alkalinity	350 mg/L
Total Dissolved Solids	3500 mg/L
Total Suspended Solids	300 mg/L
pH	10.5 - 12



**NOTE:**

**Do not add any chemicals to the boiler feed water unless specifically recommended by a qualified and recognized water treatment company.**

## 1.3 Steam Outlet

Connect steam line of sufficient size from steam line valve to the equipment. Steam piping must be black steel pipe, not galvanized. Work must be done by an experienced steamfitter. All state and local codes must be met.

## 1.4 Condensate Return

If the condensate is to be returned by gravity (no tank) in a closed system, the load discharge should be at least 2 feet above the boiler level so that the weight of the condensate will actuate the check valve. When applicable, install steam return lines at sufficient height to allow a pitch of 2 inches for every 10 feet of pipe length.

Note: For condensate return systems (with tank), see special sheet.

## 1.5 Safety Valve

If it is required that discharge piping be installed from the safety valve (3), the pipe should not be smaller than the valve outlet and should be rigidly supported so as not to place weight on the valve itself.

Important: **No valve in this line!**



## 1.6 Electrical

To hookup power and control voltage to the boiler, please proceed as indicated in FIGURE1. To ensure proper connection, please refer also to the attached wiring diagram and labels next to the field wiring terminals for proper conductor size and maximum torques that can be applied to the terminal contacts. Boilers that are equipped with a control voltage transformer need the power hookup only.



**WARNING**

**All wiring must be installed in accordance with the National Electric Code and any local codes that may apply. Wiring must be done by a competent, certified electrician. For this service, the N.E.C. requires supply wires rated at 125% of full load. Use only copper wire. Install a fused disconnect switch within sight of the boiler. Connect power supply to the terminals in control panel.**

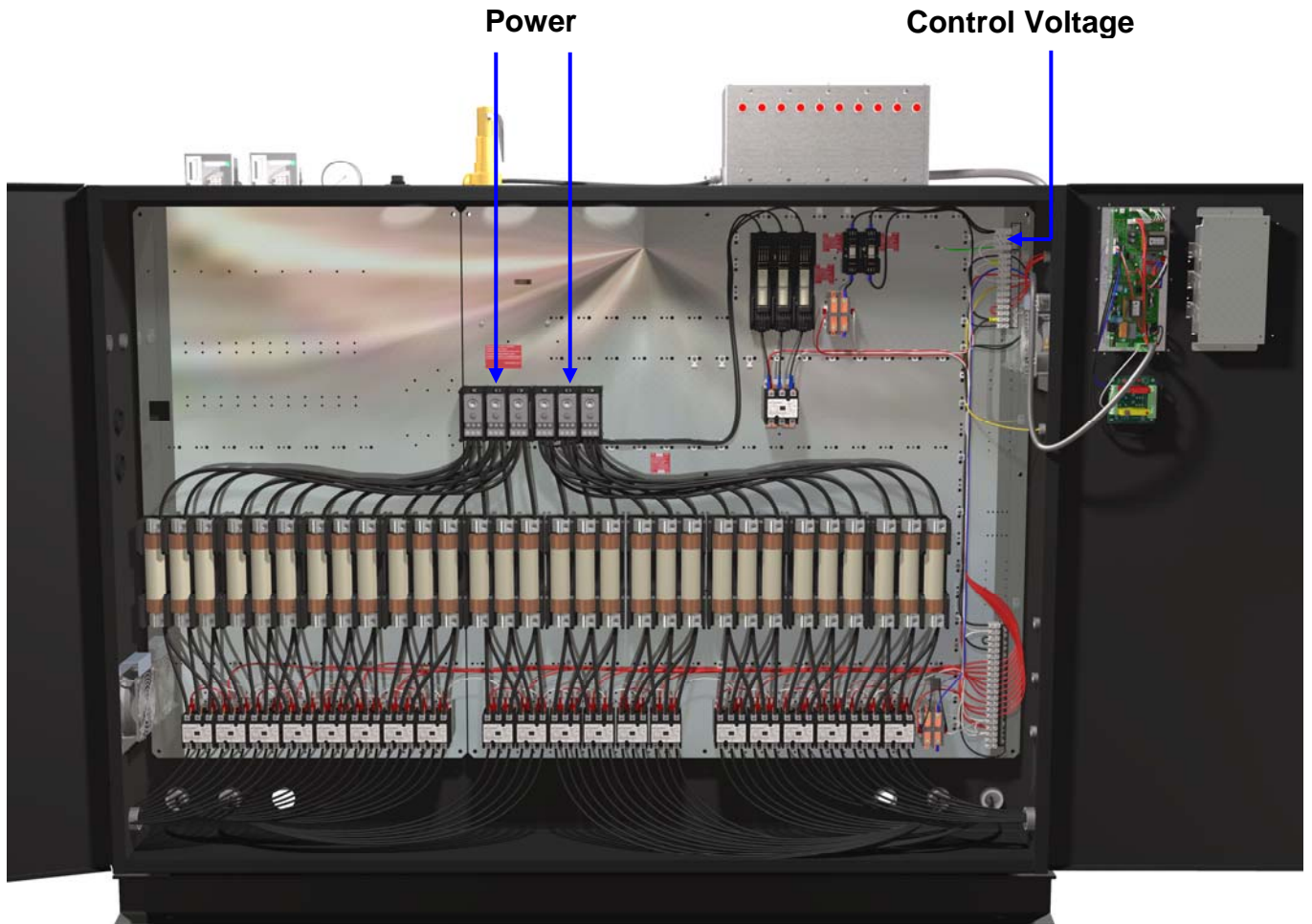

**Figure 1**

## 2. Operation

### 2.1 Quick Startup

a.) Open valves as indicated.

Open steam line valve slightly. This will allow the boiler to be filled without producing back pressure.

#### RHP & RHPH Models

Open the gauge glass valves

Open feed water shutoff valve

Close boiler blowoff valve

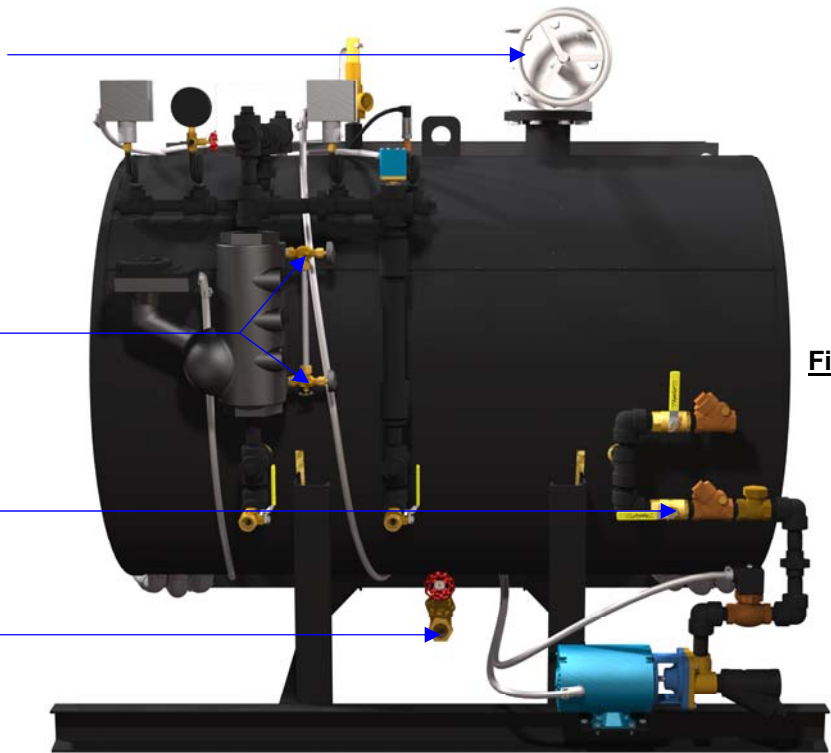

**Figure 2**

Open steam line valve slightly. This will allow the boiler to be filled without producing back pressure.

#### RHPHC Models

Open the gauge glass valves

Open feed water shutoff valve

Close boiler blowoff valve

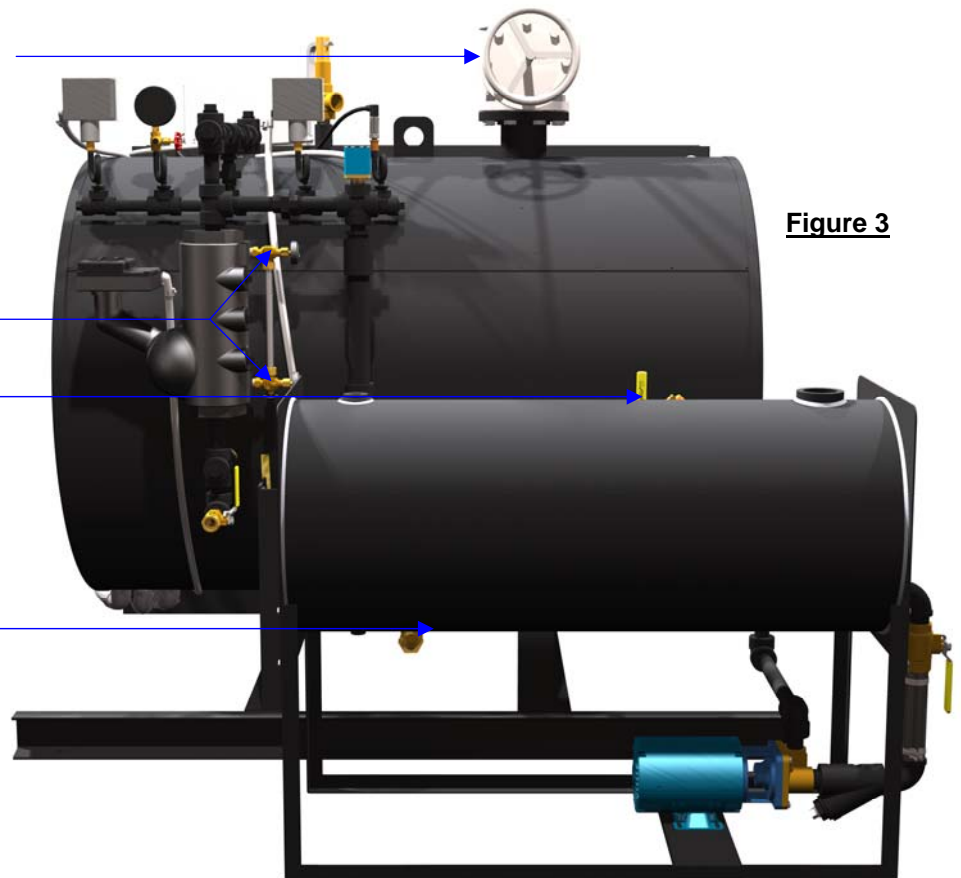

**Figure 3**

b.) Throw fused disconnect switch (not provided as standard equipment by factory) to the ON-position and turn on the boiler control voltage.

c.) Turn POWER switch on. \_\_\_\_\_  
 The REFILLING light turns on and water enters the boiler. As soon as the water level reaches approximately 1/2 of gauge glass, the automatic water feed turns off.  
**Caution: Do not leave the pump to run dry!**



**Figure 4**

d.) Close the steam line valve.

If the boiler controller indicates any boiler alarms, then press the corresponding alarm reset switch.

As soon as no boiler alarms are indicated, the HEATING light turns on, the heating stages step in, and the boiler starts to build up pressure.

Observe the pressure gauge while pressure builds up. The working pressure has been factory set to your specification. As soon as the boiler pressure approaches the pressure setting in the PID-controller, the heating stages of the Element Stager begin to step out. As soon as the boiler pressure reaches the pressure setting in the PID-controller, all heating stages should be off.

If you wish to change the working pressure setting, proceed as follows:

- Press the <MENU> key on the PID-Controller for about one second
- Select PROGRAM
- Select MOD1
- Select SETPOINT
- With the UP and DOWN keys, set new boiler working pressure.

Do not set the boiler working pressure too close to the settings of the pressure high limit controls S1 and S2, otherwise they may trip.

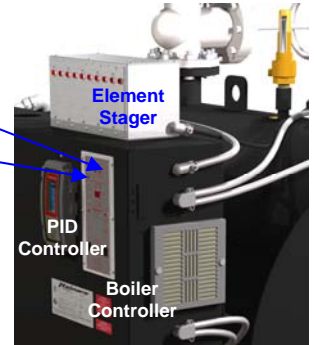

**Figure 5**

e.) Open the steam outlet valve slowly to supply steam to your application

**f.) Safety Limit Controls**

This boiler is equipped with Low Water Cut-Off Limit Controls and Pressure High Limit Controls:

S1: Pressure High Limit Control with Manual Reset Function. This control is set at least 7psi above the setting of S2. As soon as this control trips, the heating function of the boiler will be locked out and the HIGH PRESSURE ALARM light will be lit.

S2: Pressure High Limit Control with Automatic Reset Function. This control is set at least 7psi above the boiler working pressure setting of the PID-Controller.

The water level probe connected to the boiler controller provides the low water cut-off function with manual resettable lockout. Chapter 2.2.2. provides a detailed description of this function.

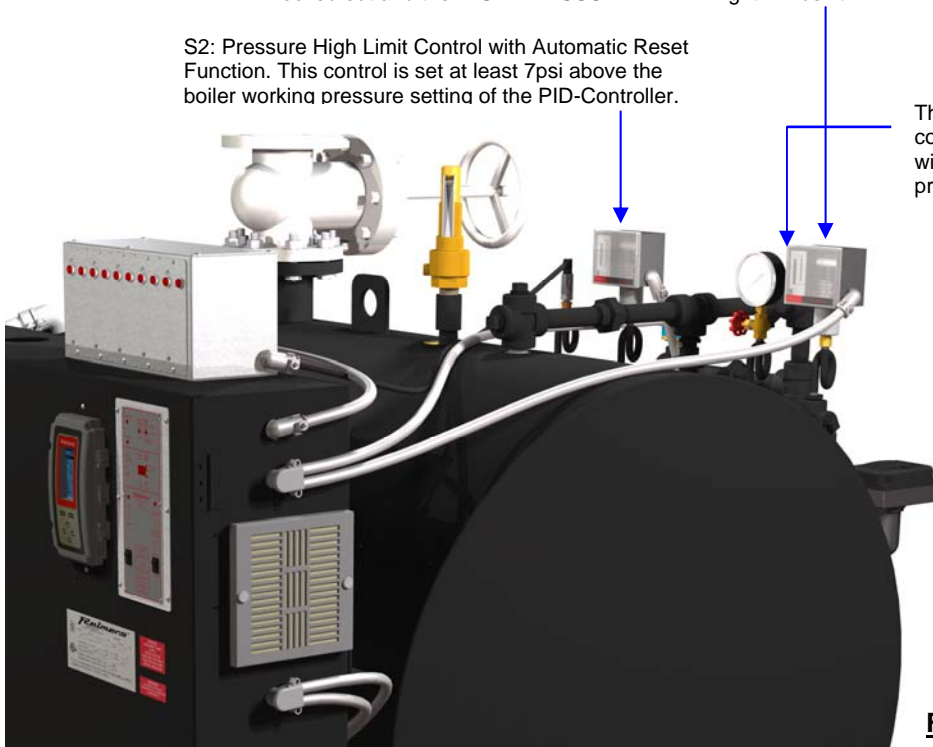

The McDonnell & Miller 157 boiler control provides automatic boiler refill sensing and primary low water cut-off function with automatic reset.

It operates ahead of the secondary low water cut off control with manual reset

**Figure 6**

## 2.2 Setting and Changing Boiler Operating Parameters on the Boiler Controller

### 2.2.1 Boiler Controller Overview

The boiler controller provides all functions for the operation of the RHP and RPHC boiler models:

Basic Functions:

- Low water cutoff
- Automatic boiler refill
- Boiler operation monitor functions

Optional Functions:

- High water level feed shutoff (Optional)
- Automatic boiler blow-off (Optional)
- Remote controlled boiler ON/OFF and boiler status (Optional)

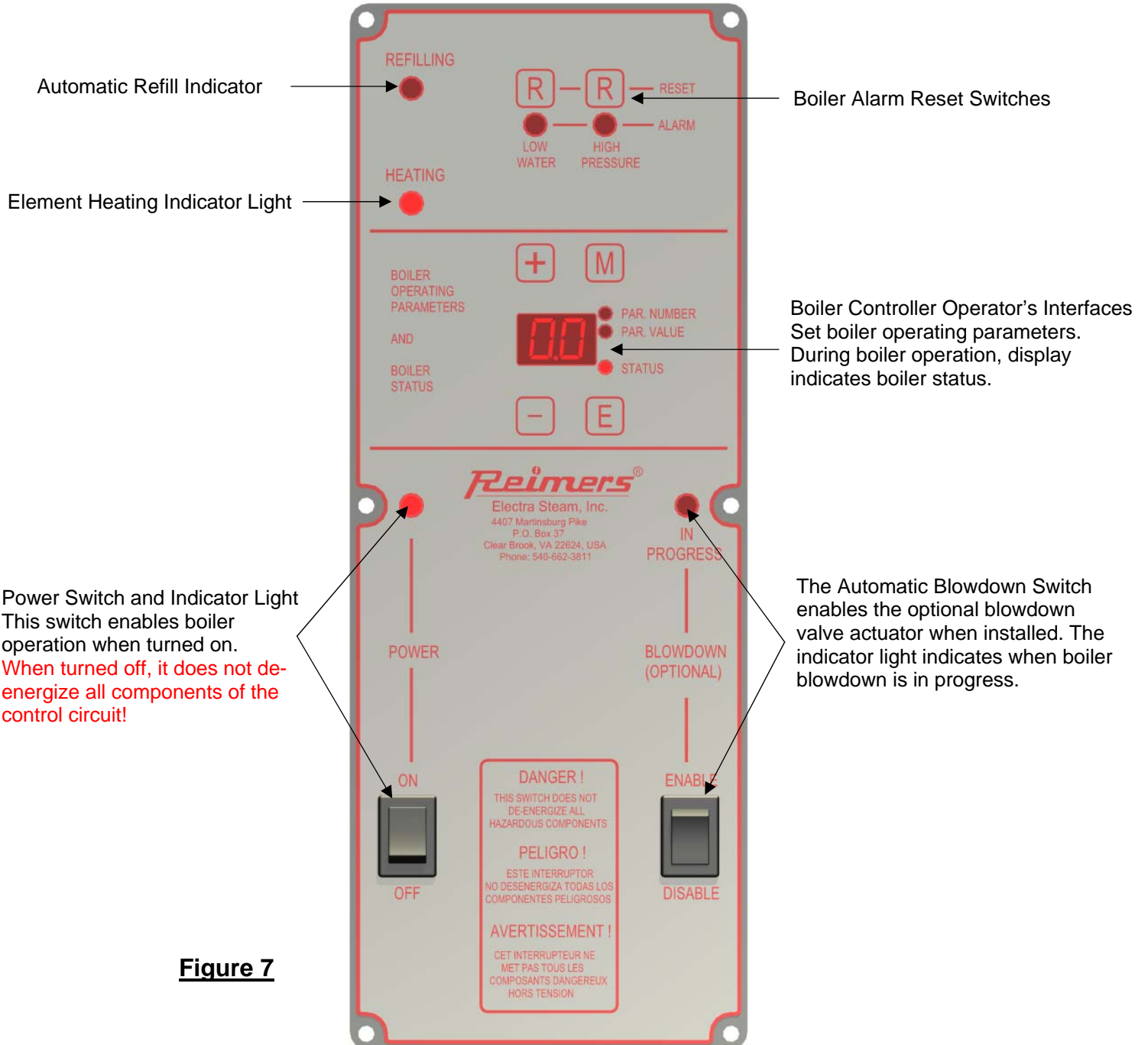

**Figure 7**





## 2.2.2 Low Water Cut-Off Function

The main task of the low water cutoff module is to de-energize the heating elements when the water level in the boiler pressure vessel falls below the minimum acceptable operating level. The low water cutoff control 04316 senses the water level in the boiler pressure vessel with the low water cutoff probe E3.

The water level is processed by the control as normal when the tip of the probe E3 is in contact with water. When the water level in the boiler falls below the tip of the probe E3, then it is processed by the control as too low.

This control provides timing against short cycling, which avoids boiler shutdown when the probe E3 loses contact with the boiler water for a short period of time. Once the short cycling timer has elapsed (times are adjustable and can be set as shown below), the control de-energizes the heating elements and turns on the boiler alarm light “LOW WATER”. This alarm light indicates that the water level in the boiler shell is too low and that the heating power is locked out. Boiler operation can be resumed only after restoring normal water level in the boiler shell and then pressing the “LOW WATER” reset (R) key. After pressing this key, the alarm light “LOW WATER” turns off and the lockout is removed.

The second task of the low water cutoff control is to provide manual reset function for the high limit pressure control. If the operating pressure control fails, the steam pressure in the boiler pressure vessel can reach the value set on the high limit pressure control. In that case, the high limit pressure control de-energizes the heating elements. Lockout occurs as described above. The boiler alarm light “HIGH PRESSURE” remains on until the boiler steam pressure falls below the setting of the high limit pressure switch and the “HIGH PRESSURE” reset (R) key is pressed. After pressing this key, the alarm light “HIGH PRESSURE” turns off and the lockout is removed.

Function	DIP-switch	Description
1		Low water cutoff function. When the water level in the boiler pressure vessel is too low for more than $t_{\text{lockout}} = 3\text{seconds}$ , the low water cutoff module de-energizes and locks out the heating elements.
2		Same as Function1 plus automatic restart after boiler blowdown: Low water cutoff module allows after power on 10minutes boiler refill, while it keeps the heating elements de-energized. During this time no lockout is generated.
3		Same as Function1, but with adjustable time delay $t_{\text{lockout}}$ . Time range is 6 to 60seconds.
4		Same as Function2, but with adjustable time delay $t_{\text{lockout}}$ . Time range is 6 to 60seconds.

The RHP and RHPHC steam boiler models ship with the low water cutoff module 04316 configured to Function2. If a different configuration is desired, then the specified sequence shown below must be performed:

- 1 Turn the boiler controller POWER switch off
- 2 Move all DIP-switches into on-position
- 3 Turn POWER switch on
- 4 Set Lockout Time  $t_{\text{lockout}}$ : (applicable only for Function3 or Function4)
  - a. Press and hold “HIGH PRESSURE” reset (R) key
  - b. Press for 1 sec. and release for 1sec. the “LOW WATER” reset (R) key once for each 6seconds of delay time.
- 5 Turn POWER switch off
- 6 Select function by sliding DIP-switches as shown above
- 7 Turn on POWER switch for 4seconds
- 8 Turn off POWER switch for 4seconds
- 9 Turn on POWER switch for 4 seconds.
- 10 Turn off POWER switch for 4 seconds.
- 11 The boiler control is now ready to function. Turn POWER switch on.

## 2.2.3 Setting Boiler Operating Functions, Monitors and Parameters

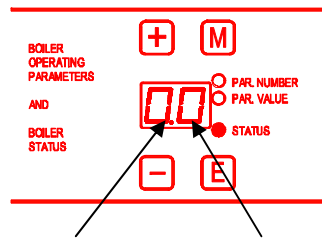

Boiler Function Configuration      Boiler Monitor Configuration

RHPH and RPHC boiler models usually ship with the boiler controller configured set as shown. No adjustments to the boiler controller need to be made in order to operate the boiler.

The left display digit indicates the selected boiler function configuration, whereas the right display digit indicates the boiler monitoring configuration.

### Example:

**The Boiler Function Configuration “0”** selected above indicates that the following boiler functions are enabled:

“Automatic boiler refill function with the following parameters:  
 “Refill ON-delay time”= 0seconds (PAR. NUMBER 20)  
 “Refill OFF-delay time” = 3seconds (PAR. NUMBER 21)

And

“Pressure controlled boiler blowdown function” with parameter:  
 “Blowdown duration” = 4minutes (PAR. NUMBER 31)  
This function is only available when the boiler is equipped with the Automatic Flush & Drain Option, OPT1016.

Please refer to **Table1** for all available function configurations and detailed boiler function descriptions.

**The Boiler Monitor Configuration “0”** selected above indicates that the following boiler monitors are enabled:

“Automatic boiler refill monitor” with parameters  
 “Initial automatic boiler refill timeout after power-on = 20minutes (PAR. NUMBER22)  
 “Automatic boiler refill timeout during boiler operation = 4minute (PAR. NUMBER23)

And

“Boiler high water level cut-off monitor”  
In its standard configuration the RHP-boiler series is not equipped with a high water level cut-off probe.

Please refer to **Table2** for all available boiler monitor configurations and their detailed description.

In order to make changes to the boiler controller configuration, proceed as follows:

a.) Before setting parameters, a pass code must be entered. This keeps unauthorized personnel from changing controller configurations. In order to enter the pass code, follow the steps below:

While the power switch is in ON-position, and the “STATUS”-LED is lit, press and hold the <-> and <E> keys at the same time. With <-> and <E> keys pressed, enter the following sequence on the <+> and <M> keys: <+>, <M>, <+>, <+> and <M>. Once the code is entered correctly, the light on the menu-LED’s toggles from “STATUS” to “PAR. NUMBER” and the controller is ready for boiler operating parameter changes.

With <-> and <E> pressed, enter:  
 <+>, <M>, <+>, <+> and <M>

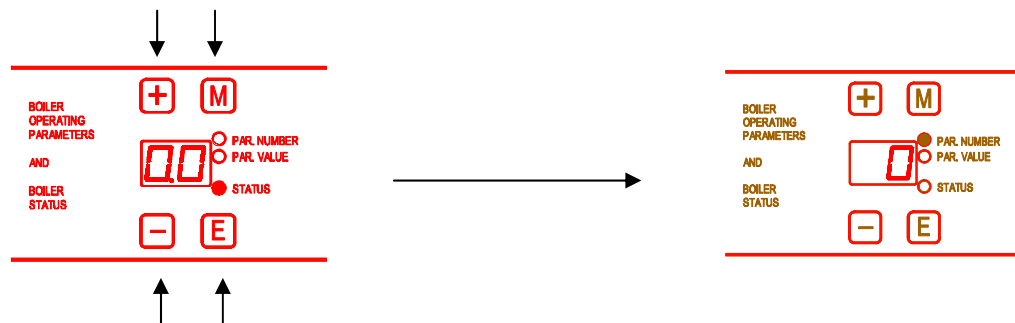

Press and hold these keys

b.) Press the <+> and/or <-> keys to set the boiler operating parameter number. When the parameter number is set, press the <M> key. This will toggle the light on the menu-LED's from "PAR. NUMBER" to "PAR. VALUE" and the controller is ready for the selected boiler operating parameter value to be set.

Set parameter number

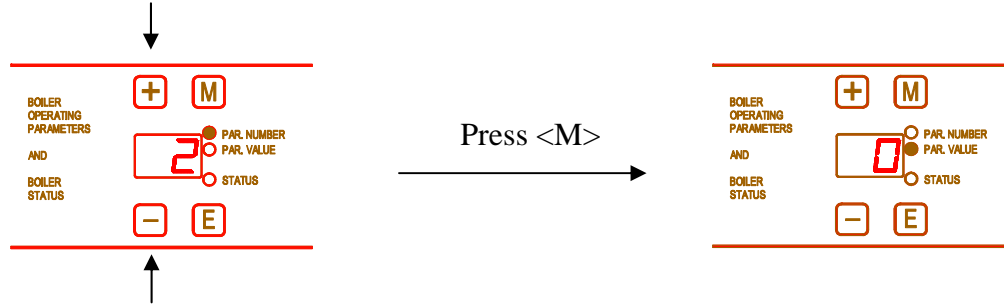

Set parameter number

c.) Press the <+> or <-> key to set the selected boiler operating parameter value.

Set parameter value

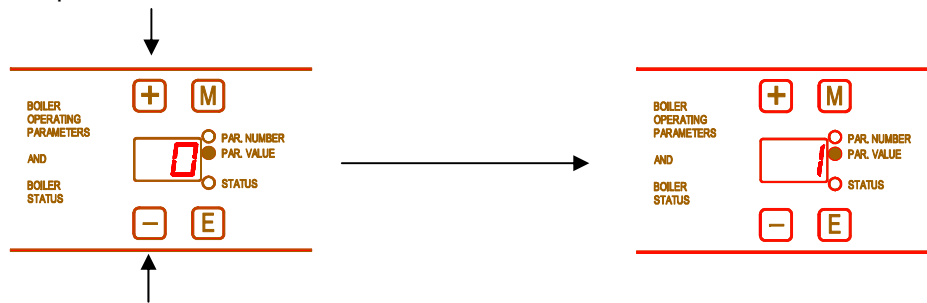

Set parameter value

d.) To set the next boiler operating parameter, press the <M> key. Repeat item b.) and c.) until all required boiler operating parameters are set.

e.) To exit the boiler parameter setting menu, press the <E> key. Once the <E> key is pressed, the light toggles from the "PAR. VALUE"-LED to the "STATUS"-LED and the new boiler status is displayed.

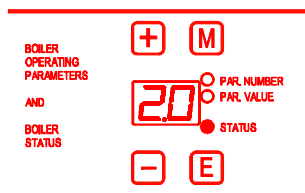

The following Tables provide an overview of all available boiler and monitor function configurations (Table1 and Table2). Table 3 provides an overview of all operating parameters used in the boiler and monitor functions.

**Table 1: Boiler Function Configurations**

PAR. NUMBER	PAR. VALUE	PARAMETER DESCRIPTION
0	0	Boiler-Functions Configuration 0 disabled.
	1	Boiler-Functions Configuration 0 enabled = <b>"0" displayed in left digit of LED-Display</b> . <ul style="list-style-type: none"> <li>- <b>Automatic boiler refill function</b> , refill ON-delay time = 0seconds, refill OFF-delay time = 3seconds.</li> <li>- <b>Pressure controlled boiler blowdown function</b> (Automatic Flush &amp; Drain) with blowdown duration = 4minutes. (Enable/disable this function with BLOWDOWN ENABLE switch on boiler controller)</li> </ul>
1	0	Boiler-Functions Configuration 1 disabled.
	1	Boiler-Functions Configuration 1 enabled = <b>"1" displayed in left digit of LED-Display</b> . <ul style="list-style-type: none"> <li>- <b>Automatic boiler refill function</b> , refill ON-delay time = 0seconds, refill OFF-delay time = 10seconds.</li> <li>- <b>Pressure controlled boiler blowdown function</b> (Automatic Flush &amp; Drain) with blowdown duration = 4minutes. (Enable/disable this function with BLOWDOWN ENABLE switch on boiler controller)</li> </ul>
2	0	Boiler-Functions Configuration 2 disabled.
	1	Boiler-Functions Configuration 2 enabled = <b>"2" displayed in left digit of LED-Display</b> . <ul style="list-style-type: none"> <li>- <b>Automatic boiler refill function</b> , refill ON-delay time = <b>PAR. NUMBER20</b> (0 – 10seconds), refill OFF-delay time = <b>PAR. NUMBER21</b> (3 – 11seconds).</li> <li>- <b>Pressure controlled boiler blowdown function</b> (Automatic Flush &amp; Drain) with blowdown duration = <b>PAR. NUMBER31</b>. (1 - 20 minutes), (Enable/disable this function with BLOWDOWN ENABLE switch on boiler controller)</li> </ul>
3 - 9	0	Boiler-Function Configurations 3 - 9 disabled.
	1	Boiler-Function Configuration 3 - 9 enabled: No functions implemented yet.

## Boiler Function Definitions

### Automatic boiler refill function

#### Sequence of Events:

- As soon as the POWER switch on the boiler controller is turned off, the boiler controller de-energizes the boiler feed water pump and/or solenoid valve.
- If the POWER switch is turned on:
  - o As long as the water level-float in the McDonnell & Miller (MM157) does not call for boiler refill, the boiler controller keeps the boiler feed water pump and/or solenoid valve de-energized.
  - o As soon as the MM157 calls for boiler refill, the boiler controller energizes the boiler feed water pump and/or solenoid valve after the elapse of the refill ON-delay time (**PAR. NUMBER20**).
  - o As soon as the MM157 does not call for boiler refill, the boiler controller de-energizes the boiler feed water pump and/or solenoid valve after the elapse of the refill OFF-delay time (**PAR. NUMBER21**).

### Pressure controlled boiler blowdown function

This function requires the Blowdown Valve Actuator and Blowdown Enable Pressure Control (#OPT1016) installed on the boiler.

#### Sequence of Events:

- As soon as the POWER switch on the boiler controller is turned on, the boiler controller de-energizes the Blowdown Valve Actuator (B2).
- With POWER switch turned off and as soon as the boiler pressure falls below the setting of the Blowdown Enable Pressure Control (S5), the boiler controller generates a 6second time delay. As soon as this time delay has elapsed, the boiler controller energizes (opens) the Blowdown Valve Actuator (B2) for a time (in minutes) saved in **PAR. NUMBER31**.
- After the time saved in **PAR. NUMBER31** has elapsed, the boiler controller de-energizes (closes) the Blowdown Valve Actuator (B2).



**Table 2: Boiler Monitor Configurations**

PAR. NUMBER	PAR. VALUE	PARAMETER DESCRIPTION
10	0	Boiler-Monitoring Configuration 0 disabled:
	1	Boiler-Monitoring Configuration 0 enabled = <b>“0” displayed in the right digit of the LED-Display.</b> - <b>Automatic boiler refill monitor.</b> Initial automatic boiler refill timeout after power-on = PAR. NUMBER22 (1 – 30minutes), automatic boiler refill timeout during boiler operation = PAR. NUMBER23 (1- 10minutes) - <b>Boiler High Water Level Cut-Off Monitor.</b>
11	0	Boiler-Monitoring Configuration 1 disabled:
	1	Boiler-Monitoring Configuration 1 enabled = <b>“1” displayed in the right digit of the LED-Display.</b> - <b>Boiler blowdown monitor.</b> Expected automatic boiler refill time after blowdown = PAR. NUMBER32 (0 – 99seconds). - <b>Boiler High Water Level Cut-Off Monitor.</b>
12	0	Boiler-Monitoring Configuration 2 disabled:
	1	Boiler-Monitoring Configuration 2 enabled = <b>“2” displayed in the right digit of the LED-Display.</b> - <b>Automatic boiler refill monitor.</b> Initial automatic boiler refill timeout after power-on = PAR. NUMBER22 (1 – 30minutes), automatic boiler refill timeout during boiler operation = PAR. NUMBER23 (1- 10minutes) - <b>Boiler blowdown monitor.</b> Expected automatic boiler refill time after blowdown = PAR. NUMBER32 (0 – 99seconds). - <b>Boiler High Water Level Cut-Off Monitor.</b>
13 - 19	0	Boiler-Monitoring Configuration 4 - 9 disabled:
	1	Boiler-Monitoring Configuration 4 - 9 enabled: No monitors implemented yet.

**Boiler Monitor Definitions**

**Automatic boiler refill monitor:**

**Flashing “0” in controller display = this boiler monitor generated an alarm. Press <E> to reset.**

**Sequence of Events:**

- As soon as the POWER switch on the boiler controller is turned off, the automatic boiler refill monitor is disabled.
- After the POWER switch is turned on, the automatic boiler refill-monitor measures the duration of each refilling cycle.
  - o If the feed water pump and/or solenoid valve remains energized for more than the time duration saved (in minutes) in PAR. NUMBER22, the boiler controller de-energizes the feed water pump and/or solenoid valve and displays a flashing “0” on the LED-display. The feed water pump and/or solenoid valve remains de-energized (off) until the “E”-key on the controller’s key pad is pressed. As soon as the “E”-key is pressed, the boiler controller displays the current boiler function and monitor configurations again and starts a new refilling attempt. PAR. NUMBER22 should be set to approximately 1.5 x the time that the feed water pump and/or solenoid valve needs under normal operating conditions to fill the completely empty boiler to nominal water level.
  - o As soon as a refilling cycle is completed within the time saved in PAR. NUMBER22, the boiler controller will monitor all following refilling cycles as indicated above, except that it will use the time duration saved (in minutes) in PAR. NUMBER23. PAR. NUMBER23 should be set to approximately 3 x the time that the feed water pump and/or solenoid valve needs under normal operating conditions to refill the boiler from minimum to nominal water level. Usually PAR. NUMBER22 is 4 to 5 times greater than PAR. NUMBER23.

**Boiler blowdown monitor**

**Flashing “1” in controller display = this boiler monitor generated an alarm. Press <E> to reset.**

**Sequence of Events:**

As soon as the POWER switch on the boiler controller is turned on, the boiler blowdown monitor checks whether the boiler blowdown function completed a blowdown cycle while the POWER switch was turned off. If that was the case, then this monitor checks further whether the automatic refilling device (feed water pump and/or solenoid valve) remains on for the minimum expected time saved in PAR. NUMBER32. If the automatic refilling device turns off, before the time saved in PAR. NUMBER32 has elapsed; the boiler controller displays a flashing “1” on the LED-display. All boiler functions remain active. The flashing “1” indicates only that the last boiler blowdown attempt was not successful. As soon as the “E”-key is pressed, the boiler controller displays the current boiler function and monitor configurations again.

**Boiler High Water Level Cut-Off Monitor**

**Flashing “2” in controller display = this boiler monitor generated an alarm. Press <E> to reset, or alarm resets automatically (ref. to Sequence of Events below).**

This monitor requires the high water cut-off probe (E2) and steam solenoid valve (SOL2) installed and connected to the boiler. The steam solenoid valve is installed into the steam outlet line of the boiler.

**Sequence of Events:**

As soon as the high water level cut-off probe (E2) comes in contact with boiler water, the boiler controller turns off the automatic refilling device (feed water pump and/or solenoid valve). At the same time the boiler controller turns off the power to the heating elements, closes the steam outlet line through the solenoid valve (SOL2) and displays a flashing “2” on the LED-display. As soon as probe E2 losses contact with boiler water and PAR. NUMBER40 is set to “0”, the boiler controller resumes normal boiler operation automatically. If PAR. NUMBER40 is set to “1”, press the “E”-key to resume normal boiler operation.

**Table 3:**

20	0...10	Automatic boiler refill ON-delay time, in seconds.
21	0...11	Automatic boiler refill OFF-delay time, in seconds.
22	1...30	If PAR. NUMBER 10 = 1: Initial automatic boiler refill timeout after power-on, in minutes.
23	1...10	If PAR. NUMBER 10 = 1: Automatic boiler refill timeout during boiler operation, in minutes.
24		
25		
26		
27		
28		
29		
30	0	Pressure controlled boiler blow-off function (Automatic Flush and Drain) disabled.
	1	Pressure controlled boiler blow-off function (Automatic Flush and Drain) enabled.
31	1...20	Pressure controlled boiler blow-off duration (Automatic Flush and Drain), in minutes.
32	0...99	Expected automatic boiler refill time after blowdown, in seconds.
33		
34		
35		
36		
37		
38		
39		
40	0	Automatic alarm reset after high water cut-off alarm.
	1	Manual reset after high water cut-off alarm.

## 3. Maintenance



### CAUTION

Repair must be performed by experienced personnel. Ensure that the boiler is cold, drained and has no pressure or electricity. All electrical and steam safety precautions must be taken.

### 3.1 Blowoff



### WARNING

Stand clear of scalding water and steam. Ensure that the blowdown is safely piped.

All boilers must be blown off periodically to remove minerals, scale and other foreign matter, which accumulate inside the pressure vessel. The concentration of this deposit depends in part upon the condition of the water in the area. When water is naturally soft, or has been softened chemically, boiler blowoffs are required less often than in areas where hard water is found. Water softeners are suggested in hard water areas to minimize the formation of hard scale on heating elements. Another factor affecting water condition is the amount of condensate, if any, that is being returned to the boiler. Since condensate is essentially clean distilled water, it contains very few impurities. If a large part of the condensate is being returned and little make-up water is used, the boiler need not be blown down as often as when little or no condensate is returned to the boiler. We recommend to blowoff newly installed steam boilers once per day until the first heating element and pressure vessel inspection is performed (refer to chapter 3.4). If no significant amount of sediment is found on the bottom of the pressure vessel and on the heating element sheaths, then the boiler blowoff frequency can be reduced accordingly. The safest method to blowoff RHP-series steam boilers is to install a Reimers Electra Steam properly sized and fully trimmed blowdown tank, model BTANK-750-US/CRN (Figures 7 and 8). Reimers blowdown tanks are designed and constructed to Section VIII of the A.S.M.E. Code and inspected by a commissioned National Board Boiler inspector.

#### Blowdown Tank Installation

Pipe the blowdown tank to the steam boiler, cold water line and drain as shown in the Figures below. All piping must conform to the A.S.M.E. B31.1 Power Piping Code. The blowoff line between steam boiler and blowdown tank shall be made from black SCH80 steel pipe and the pipe fittings shall be of black steel. **No galvanized piping for this service!** The vent pipe must be not longer than 50ft. and should be vented without any restrictions to the atmosphere with a minimum of turns. Pipe the blowdown tank drain to a safe place of discharge.

Boiler blowoff can be performed either manually (Figure 7) or fully automatic (Figure 8). Reimers Electra Steam offers two fully automatic boiler blowoff options:

- a.) Cost efficient boiler pressure triggered blowoff (Automatic Flush & Drain) package, model OPT1016 for applications in which the boiler operates during daytime and is shutdown during nighttime.
- b.) Timer triggered blowoff package, model OPT1001 when boiler operates 24/7

If one of the fully automatic blowoff options is installed and the blowdown tank drains directly to the sewer, we recommend the installation of the automatic after cooler package, model OPT1027 into the blowdown tank drain line.

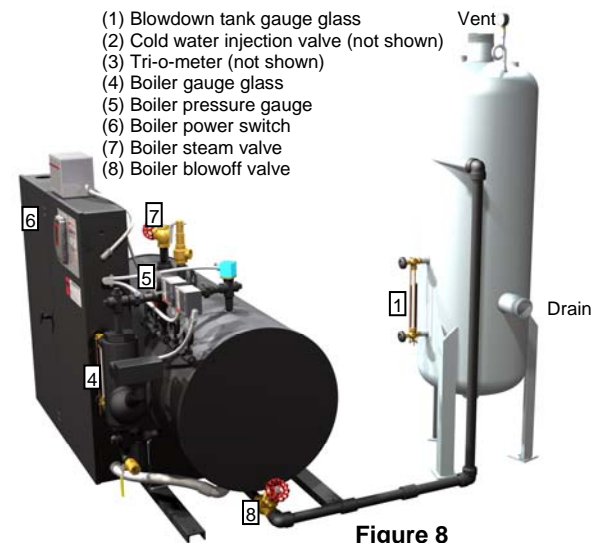

Figure 8

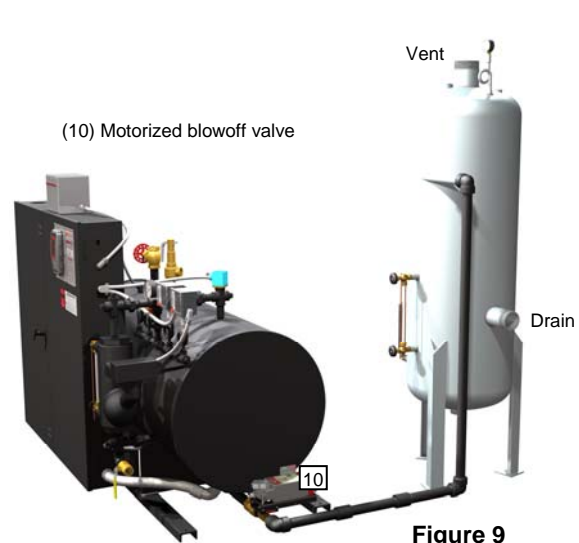

Figure 9

- Ensure that blowdown tank gauge glass (1) is half filled with water. If not, open the cold water injection valve (2) and fill blowdown tank until water level reaches half height of gauge glass.
- Ensure that the Tri-o-meter (3) indicates a temperature of not more than 70° F. If not, open the cold water injection valve until the temperature of 70° F is reached.
- Ensure that the boiler gauge glass (4) is filled approximately 1/3 with water
- Ensure that the boiler pressure gauge (5) indicates at least 15psi
- Turn boiler power switch (6) to OFF-position
- Close the boiler steam valve (7)
- Open the boiler blowoff valve (8) and leave open until the water level drops out of the boiler gauge glass (4)
- Close the boiler blowoff valve (8)
- Open the boiler steam valve (7)
- Turn boiler power switch (6) to ON-position and resume boiler operation.

#### Boiler Pressure Triggered Blowoff (Automatic Flush & Drain)

- Turn boiler power switch (6) in the evening to OFF-position
- Close boiler steam valve (7)
- As soon as boiler pressure drops during night time below the setting of the Automatic Flush & Drain pressure switch, the motorized blowoff valve (10) opens for a preset time
- In the morning, turn the boiler power switch (6) to the ON-position. Boiler resumes automatically normal operation

#### Timer Triggered Boiler Blowoff

- Boiler blowoff occurs in accordance with the blowoff timer setting. After completion of the blowoff, boiler resumes normal operation.

### 3.2 Pressure Adjustment



**WARNING**

**When replacing pressure switches, boiler must be disconnected from electricity and no pressure in boiler.**

Please refer to Figure 6 for pressure control adjustment.

### 3.3 Safety Valve Test

Perform this test minimum once per month. Safety valve should be tested at nominal operating pressure.



**WARNING**

**Stand clear of safety valve and scalding steam.**

Hold trip lever open for five seconds in order to flush off valve seat. Permit valve to "slap" shut. If a leak occurs, repeat this test or replace the valve.

### 3.4 Inspecting the Heating Elements and Pressure Vessel



**WARNING**

**Ensure that the boiler is cold, drained and has no pressure or electricity**

Inspect heating elements and inner walls of pressure vessel every six months. If element rods are covered with scale or other foreign matter, check feed water quality. Clean element rods with stiff wire brush.

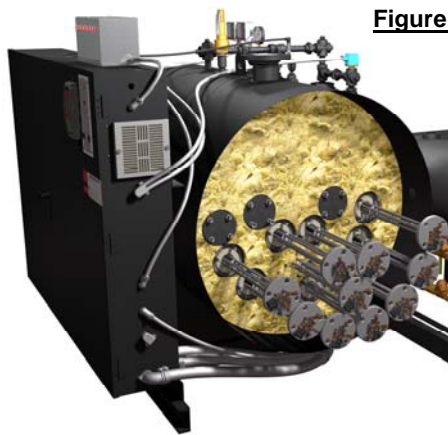

**Figure 10**

- Remove the round ends from the cylindrical shell wrapper
- Disconnect and label terminal wires
- Remove all 4 nuts from the flange of each element and pull out heating element

If the bottom of the pressure vessel is covered with a significant amount of sludge then remove same from pressure vessel, increase boiler blowoff frequency and check boiler feed water quality (see chapter 1.2)

It is normal that the inner walls of the pressure vessel be covered by a layer of red or brown or black layer of rust. However, rough pressure vessel surface and layers of rust peeling off the surface are an indication for severe corrosion. In such case, contact a water treatment company to check your boiler feed water chemistry (see also chapter 1.2).

### 3.5 Gauge Glass Replacement

Replace gauge glass minimum once per year.



**CAUTION**

**Ensure that the boiler is cold, drained and has no pressure or electricity. Be careful not to break the glass.**

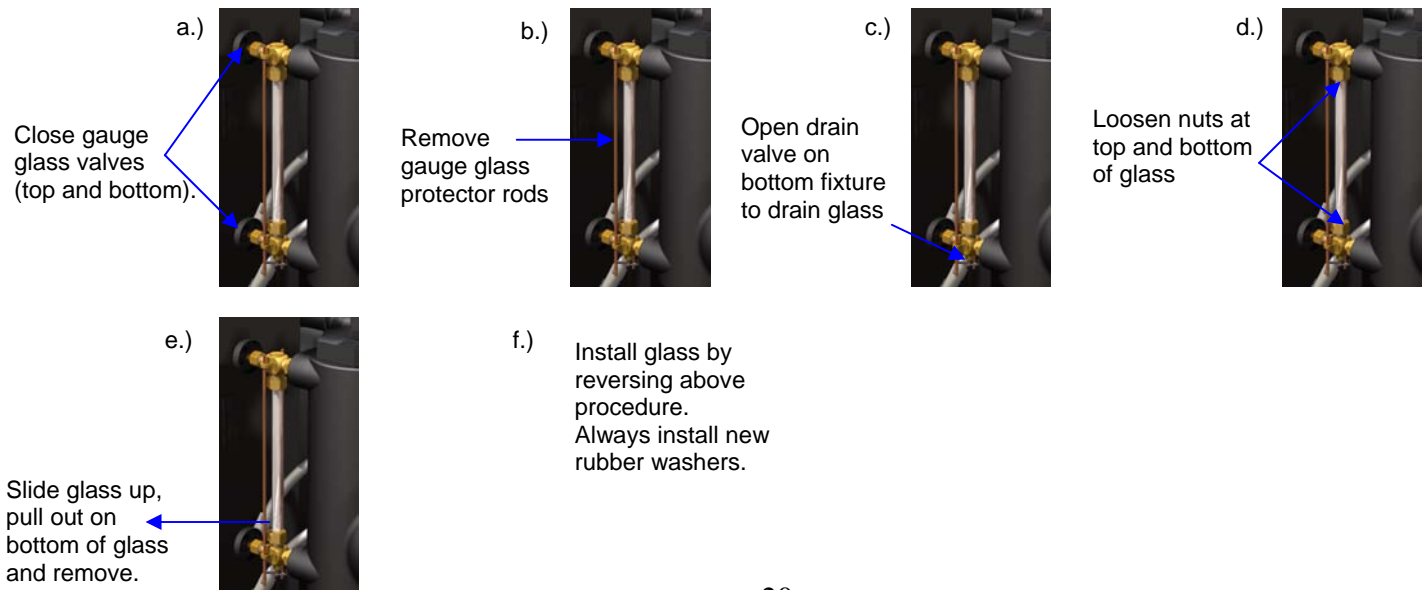

## 4. Trouble Shooting

<b>Boiler Status</b>	<b>Quick Fix</b>
Control voltage to boiler turned on, power switch on boiler control turned on, but no lights lit on the front panel of the boiler control:	<ul style="list-style-type: none"><li>- Check circuit breaker or fuse of the wall outlet where the boiler control voltage circuit is hooked up to. If the circuit breaker is tripped or the fuse blown, check whether other appliances are plugged into outlets that are fed by the same circuit breaker/fuse. If that is the case, then plug those other appliances into outlets that are protected by other circuit breakers or fuses.</li></ul>
"Low Water" alarm light on boiler control panel lit:	<ul style="list-style-type: none"><li>- Press the "Low Water" reset button</li><li>- Check Water Level. Water level must be visible in gauge glass.</li><li>- Ensure that the boiler is filled with tap water and not distilled water.</li></ul>
"High Pressure" alarm light on boiler control panel lit:	<ul style="list-style-type: none"><li>- Press the "High Pressure" reset switch</li><li>- If the pressure gauge indicates steam pressure above the preset value, reduce pressure and press the "High Pressure" reset switch again.</li></ul>

If trouble shooting did not resolve problem, please contact our service technicians at:

Phone: 540-662-3811

Email: [sales@reimersinc.com](mailto:sales@reimersinc.com)

LIVECHAT [www.reimersinc.com](http://www.reimersinc.com)

**5. Parts List for Reimers Electra Steam, Inc. RHP540 – RHP750  
High Pressure Steam Boiler Models**

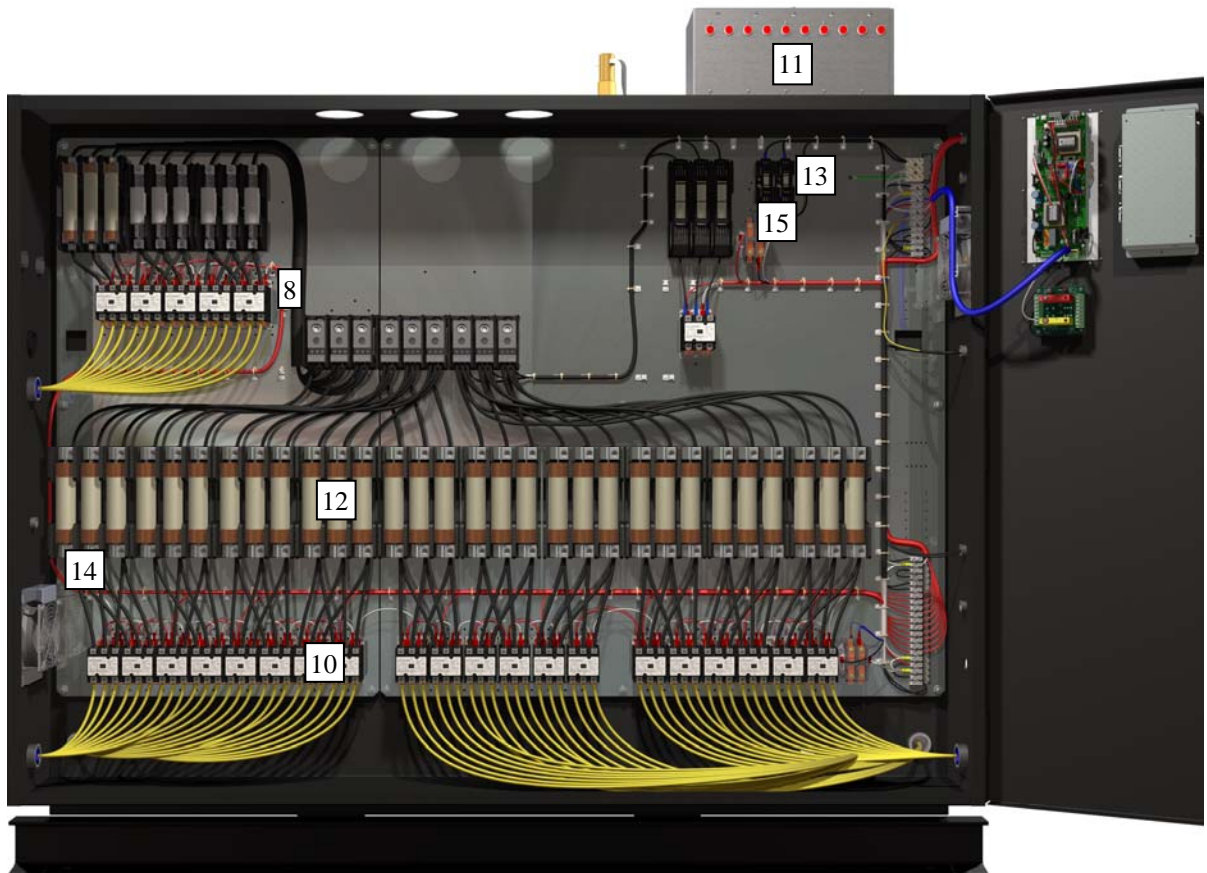
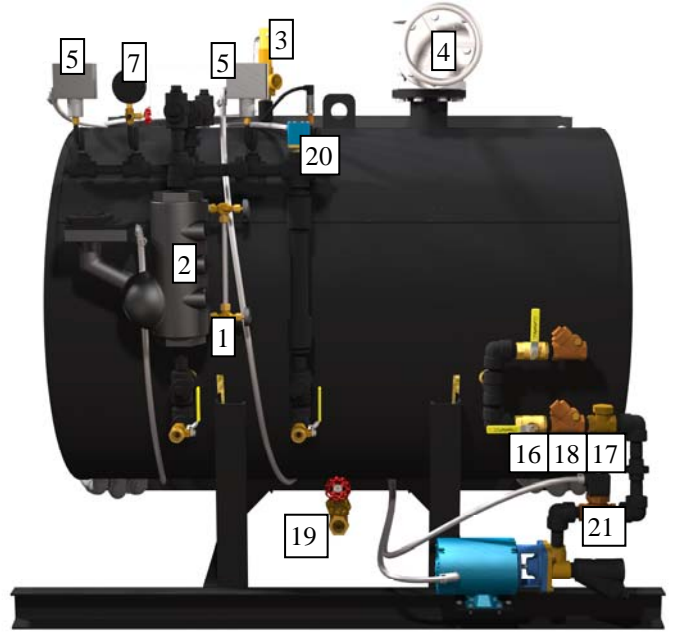

**NOTE: When ordering parts, provide boiler model, serial number and detailed shipping instructions.**

ITEM NO.	PART NO.	DESCRIPTION	BOILER MODEL
1	02396	GAUGE SET STANDARD SHANK	ALL MODELS
	02003	GAUGE GLASS 10" X .625" PYREX	ALL MODELS
	02006	GAUGE RUBBER WASHER FOR .625" GAUGE GLASS	ALL MODELS
	02448	GAUGE BRASS WASHER FOR .625" GAUGE GLASS	ALL MODELS
2	02049	MM 157S PUMP CONTROL AND LOW WATER CUTOFF	ALL MODELS
3	02392	VALVE SAFETY 1" 100 P.S.I. SWP	NOTE 2
	02028	VALVE SAFETY 1" 150 P.S.I. SWP	NOTE 2
4	05084	VALVE GLOBE 4" FLANGED	ALL MODELS
5	02297	PRESSURE CONTROL 150 P.S.I. AUTO RESET	ALL MODELS
6	05048	PID-CONTROLLER HW	ALL MODELS
7	02048	PRESSURE GAUGE 3.5" 300 P.S.I.	ALL MODELS
8	02608	ELEMENT 30kW, 240V 3Ph	NOTE 1
	03267	ELEMENT 30Kw, 380V 3Ph	NOTE 1
	02609	ELEMENT 30kW, 480V 3Ph	NOTE 1
	02610	ELEMENT 30kW, 600V 3Ph	NOTE 1
9	20838	ELECTRONIC BOILER CONTROL	ALL MODELS
10	02530	HEATING ELEMENT CONTACTOR 50A 120V 3PH	NOTE 2
	02539	HEATING ELEMENT CONTACTOR 75A 120V 3PH	NOTE 2
	02597	HEATING ELEMENT CONTACTOR 93A 120V 3PH	NOTE 2
11	20804	STEP CONTROL WITH 10 HEATING STAGES	ALL MODELS
12	02656	HEATING ELEMENT FUSE 250V 90A UL/CSA	NOTE 2
	02135	HEATING ELEMENT FUSE 600V 40A UL/CSA	NOTE 2
	02518	HEATING ELEMENT FUSE 600V 50A UL/CSA	NOTE 2
	02136	HEATING ELEMENT FUSE 600V 60A UL/CSA	NOTE 2
13	02125	CONTROL CIRCUIT FUSE 250V 15A UL/CSA	ALL MODELS
14	02144	HEATING ELEMENT FUSE BLOCKS 250V 100A	NOTE 2
	02614	HEATING ELEMENT FUSE BLOCKS 600V 60A	NOTE 2
15	02140	CONTROL CIRCUIT FUSE BLOCK	ALL MODELS
16	02514	VALVE BALL .75" 200 P.S.I. SWP	NOTE 2
	02515	VALVE BALL 1" 200 P.S.I. SWP	NOTE 2
17	02371	VALVE CHECK .75" 200 P.S.I. SWP SPRING LOADED	NOTE 2
		VALVE CHECK 1" 200 P.S.I. SWP SPRING LOADED	NOTE 2
18	02067	VALVE CHECK .75" 200 P.S.I. SWP SWING	NOTE 2
	03307	VALVE CHECK 1" 200 P.S.I. SWP SWING	NOTE 2
19	02513	VALVE 1" Y 200 P.S.I. SWP	NOTE 2
	02642	VALVE 1.25" Y 200 P.S.I. SWP	NOTE 2
20	02630	ELECTRODE PROBE FITTING	ALL MODELS
21	02301A	SOLENOID VALVE .75" NPT 120V AC	NOTE 2
	02723	SOLENOID VALVE 1" NPT 120V AC	NOTE 2

NOTE 1 – When ordering, specify voltage (V) and power (kW) of element.

NOTE 2 – When ordering, specify model number of part.