



Electra Steam, Inc.

4407 Martinsburg Pike
Clear Brook, VA 22624
USA

Phone: 540-662-3811
Fax: 540-665-8101
email: Sales@reimersinc.com
web: www.reimersinc.com

MODEL:

SERIAL #:

HLR120 – HLR180 Hydronic Boilers

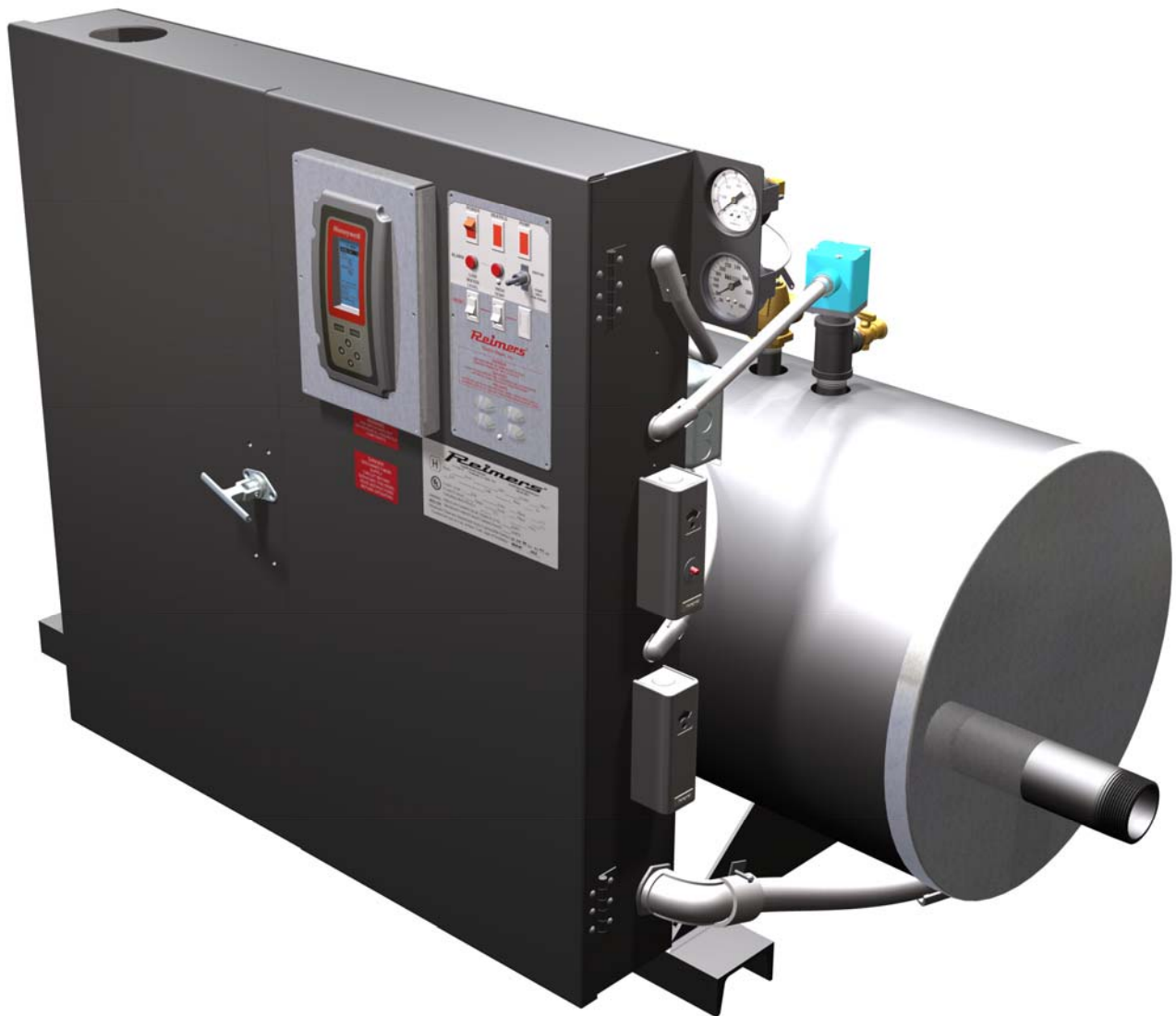

Instructions Manual

READ AND HEED FOR YOUR SAFETY

SHOCK AND BURN WARNINGS HLR & HMR ELECTRIC HYDRONIC BOILERS

You have just purchased a quality hydronic boiler designed to the ASME Boiler Code and registered with the National Board of Boiler Inspectors. Treat this industrial equipment with care and respect. It is safe when installed, maintained, and used properly. Read the instructions carefully, refer to the enclosed identification photo and contact the factory if you have any questions.

- 1.) ADJUSTMENTS:** All controls have been set at the factory and should require no adjustments. However, the boiler must be level.
- 2.) DRAIN VALVE (14):** These are utilized to blow impurities from the boiler chamber. When opened, a large volume of hot water and steam is discharged. Ensure that these are properly piped for such discharge. State and local codes must be met as applicable.
- 3.) ELECTRICAL:** All wiring must be in accordance with the National Electric Code and any local codes that may apply. Wiring must be made by a competent certified electrician. Use copper wire only.
- 4.) HOT:** The valves and piping on this unit are hot when under pressure or heating up. Don't touch.
- 5.) INSTRUCTIONS:** Read instructions before installing or operating this hydronic boiler. These are provided as general guidelines.
- 6.) MODIFICATION/MISUSE:** This boiler has been designed and constructed in accordance with the ASME Boiler Code. Any modification or misuse can result in a dangerous situation. Reimers Electra Steam Inc. is not liable for any product that has been modified or improperly used.
- 7.) PRESSURE GAGE (12):** The pressure gage indicates the internal pressure of the boiler. It can fail. Periodically have your boiler inspector compare the gage with a known gage utilizing the test valve arrangement provided. Ensure that the boiler is cold, not pressurized, and electrically disconnected.
- 8.) REGISTRATION:** Most states and cities require boiler registration and inspection. Check with your government authorities.
- 9.) REPAIR:** Repair of this unit must be attempted only by experienced personnel. Before commencing a repair, ensure that the boiler is cold, not pressurized, and electrically disconnected. All standard electrical and safety precautions must be taken during testing.
- 10.) SAFETY RELIEF VALVE (3):** The safety relief valve is designed to discharge hot steam and/or hot water when the set pressure is exceeded. Ensure that the discharge port is pointing toward the back of the unit away from the operator or any aisles. Test the safety relief valve periodically to ensure that it is operating properly. Test carefully at full pressure by lifting lever using pliers and "slapping" shut.
Danger: Discharge can scald. Ensure no one is exposed.
- 11.) INSTALLATION:** Work must be done by an experienced plumber. All state and local codes must be met as applicable.
- 12.) WATER:** Ensure that all electrical components are in a dry location, free from any possibility of water soaking.

LIMITED WARRANTY – HOT WATER BOILERS

Reimers Electra Steam, Inc. warrants the following products of its own manufacture against defects in materials and workmanship under normal use and service. This warranty is in lieu and excludes all other expressed or implied warranties or merchantability of fitness for any particular use. No person is authorized to extend the terms of this warranty or assume any other liability except by written statement signed by an officer of Reimers Electra Steam, Inc. Clear Brook, Virginia 22624.

WARRANTY PERIOD

The pressure vessel, electrical and mechanical components are warranted for one year from date of shipment from Reimers Electra Steam, Inc. in Clear Brook, VA 22624.

LIMITATIONS

Products must be installed, used and maintained in accordance with our instructions, including reasonable and necessary maintenance by the user. Users are responsible for the suitability of the products to their application. There is no warranty damage resulting from improper installation, abuse, power failure, fire, flood, lightening, improper water, misuse, improper specification, misapplication or other operating conditions beyond our control or parts that are normally expendable in usual course of operation.

Claims against carriers for damage in transit must be filed by the buyer. Reimers liability, if any, will not exceed the price of Reimers products claimed to be defective.

Components manufactured by any supplier other than Reimers shall bear only that warranty made by the manufacturer of that product and service for that warranty shall be the responsibility of that manufacturer and not Reimers.

REMEDY

Claims under this Limited Warranty must be made by obtaining a Return Authorization Number from our office (PHONE: 540-662-3811, FAX: 540-665-8101) and returning defective part, freight prepaid to: Reimers Electra Steam, Inc., 4407 Martinsburg Pike, Clear Brook, Virginia 22624.

Defective items will be repaired or replaced as necessary within a reasonable time without charge, other than incidental charges such as freight prepayment. Such repair or replacement within a reasonable time is the exclusive remedy available from Reimers Electra Steam, Inc., under this Limited Warranty.

CONSEQUENTIAL DAMAGES

Reimers Electra Steam, Inc., is not liable for labor costs incurred in the removal, reinstallation, or unauthorized repair of product, or for damages of any type whatsoever, including incidental and/or consequential damages.

THIS WARRANTY SUPERSEDES ALL PREVIOUS WARRANTIES.

1. Installation

Reimers Electra Steam Hot Water Boilers are heated by immersion-type heating elements. Automatic controls are provided to maintain pre-set operating temperature. Provision is included to connect the user's thermostat (24V AC) and circulating pump (120V). Safety features include automatic low water cut-off, automatic temperature high limit control, safety relief valve, and fuses on individual heater circuits.

Each boiler is designed to meet the requirements of ASME Standards and is individually inspected and stamped by an authorized National Board Insurance Inspector. All boilers are registered with the National Board of Boilers and Pressure Vessel Inspectors.

1. Place boiler in a level position as close as possible to the equipment to be supplied with heat. This will allow short pipe connections and minimum heat losses. Insulate all water lines where practical. Review the overall dimensions of your boiler model on page 5 to select proper boiler location.

a.) Working space:

Electric boiler spacing is dictated by the National Electrical Code (NFPA-70), Table 110.26 as follows:

Nominal Voltage To Ground (Volts)	Minimum Clear Distance		
	Condition 1	Condition 2	Condition 3
0 – 150	3ft (914mm)	3ft (914mm)	3ft (914mm)
151 – 600	3ft (914mm)	3.5ft (1.07m)	4ft (1.22m)

Note: Where the conditions are as follows:

Condition 1 — Exposed live parts on one side of the working space and no live or grounded parts on the other side of the working space, or exposed live parts on both sides of the working space that are effectively guarded by insulating materials.

Condition 2 — Exposed live parts on one side of the working space and grounded parts on the other side of the working space. Concrete, brick, or tile walls shall be considered as grounded.

Condition 3 — Exposed live parts on both sides of the working space.

(a) *Dead-Front Assemblies.* Working space shall not be required in the back or sides of assemblies, such as dead-front switchboards or motor control centers, where all connections and all renewable or adjustable parts, such as fuses or switches, are accessible from locations other than the back or sides. Where rear access is required to work on non-electrical parts on the back of enclosed equipment, a minimum horizontal working space of 762 mm (30 in.) shall be provided.

b.) Regardless of the above working space required by the National Electrical Code, the following clearance to the sides of the boiler must be provided for heating element servicing:

HLR120 – HLR180 1.5ft (460mm) on both sides of boiler



c.) Alcove or closet installation per UL834: Proper location of this boiler model with regard to combustible and noncombustible surfaces and materials is coded on the boiler name plate. The following decoding sketch and description is provided for the user information:

Model	Dimension In.						
	A	B	D	EL	ER	F	G
HLR120 – HLR180	24	A6	6	6	6	C	-

Description of dimensions and symbols

A – Clearance above top of boiler

B – Clearance from front of boiler

Prefix C to numeral indicates suitability for closet or alcove installation

Prefix A indicates suitability for alcove but not for closet installation

D – Clearance from back of boiler

EL – Clearance from left side of boiler

ER – Clearance from right side of boiler

F – Indicates type of flooring: "**NC**" for noncombustible floor / "**C**" for combustible floor. Numeral indicates minimum clearance below suspended units to combustible floor

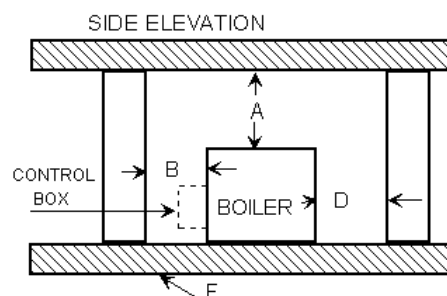
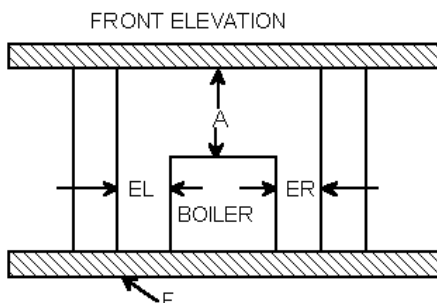



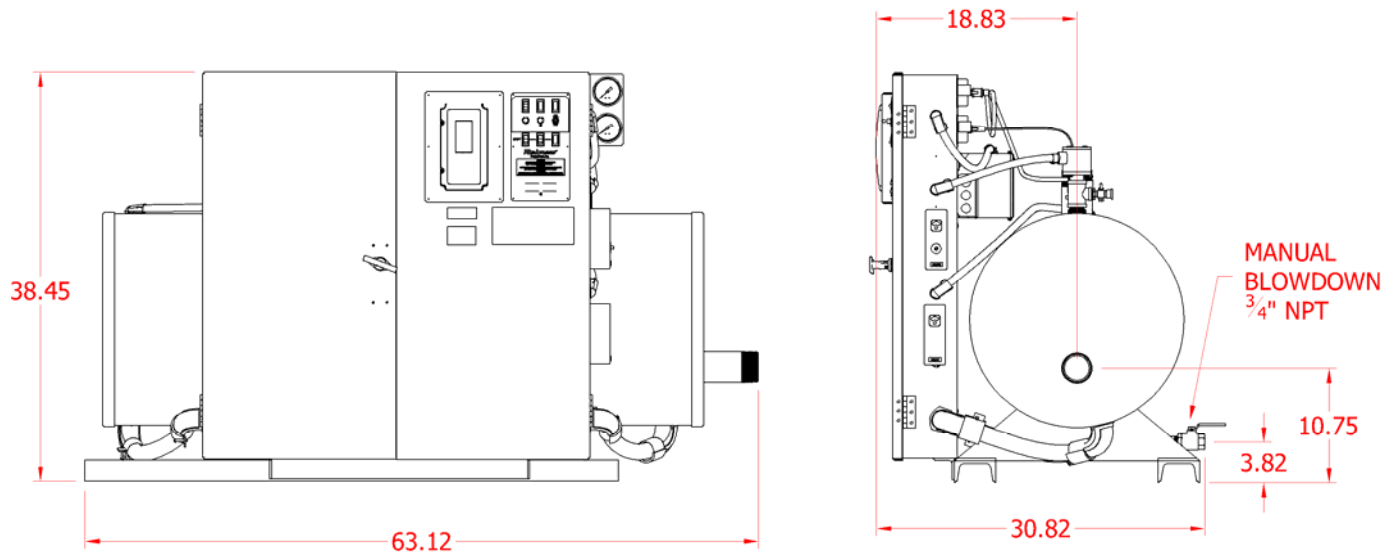

d. Dimensional Drawing HLR120 – HLR180



2. Piping: This hot water boiler is intended to be used in a closed pressure system with a circulating hot water pump. The boiler safety relief valve can have settings from 30 and up to 100psig. The expansion tank must be sized to meet the ASME standards for the overall water capacity of your heating system. The circulating system should also include an air trap and bleed, as well as automatic water fill. The water outlet is located on top of the boiler; the water inlet on the bottom right (facing the control panel).
3. Safety Valve: If removed for shipment, install the safety valve directly on boiler without cut-off valves. Direct the discharge port of the valve so that scalding anyone if the valve discharges will be avoided. If discharge piping is necessary the pipe should never be smaller than the valve outlet and should be rigidly supported, placing no weight on the valve itself.
4. Electrical:
 - a.) Each boiler - unless it is equipped with an optional control transformer - requires two separate electrical supplies. A control voltage source of 120Volt, 15Amps, 50/60Hz and a single- or three phase 240V, 380V, 415V, 480V or 600Volt service (see boiler nameplate) must be supplied to the boiler control cabinet through metallic armored cable or conduit and connected as indicated in the attached wiring diagram. For minimum ampacity of branch circuit conductors, follow all state and local codes. If such codes don't exist, provide minimum ampacity of branch circuit conductors as indicated on the markings located near the field terminals.
 - b.) Connect the circulating pump as indicated in the attached wiring diagram. The pump shall bear UL/CSA approval marking.

2. Start-Up Instructions

1. With all power disconnected, check the control panel for loose wires caused by vibration in shipping. Review installation instructions to be sure boiler is properly wired and installed.
2. Be sure boiler drain valve is closed. 
3. Fill system with water.
4. Ensure that the selector switch is in OFF-position (middle position). 
5. Turn 120-Volt power supply on. Turn red POWER switch to ON-position. 
6. Start circulating pump, or pumps by throwing the selector switch on the boiler controller into the PUMP-position. With pump running, bleed air from system and check entire system for leaks.
7. This hot water boiler is equipped in its standard configuration with one temperature sensor, placed inside the boiler pressure vessel near the water outlet nozzle. It senses the water temperature as it exits the boiler.  For space heating applications that require outdoors reset, a second sensor can be easily connected to the boiler controller in the field. To set the boiler controller for reset mode, please refer to the Honeywell T775P2003 boiler controller manual that is attached to this manual.
8. Turn three phase power supply on.
9. Turn the selector switch to HEATING-position. The boiler is now ready to operate. 
10. The Honeywell T775P2003 boiler controller is factory preset and does not require any additional adjustment. For reference purposes, the tabulation below provides all preset parameters:

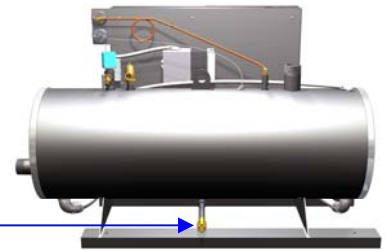

SETUP

- 1.1. Entering Setup Mode: Press and hold the MENU button for 5 seconds to display the Setup menu
- 1.2. Setting up the Sensors:
 - 1.2.1. # of Sensors = 1
 - 1.2.2. Sensor A
 - 1.2.2.1. UNITS = DEG F
 - 1.2.2.2. CALIBRATE = 0.0°F
 - 1.2.2.3. LABEL = BOILER A
 - > EXIT
 - 1.2.3. SENSOR B = Not set, unless outdoor reset sensor connected to controller
 - 1.2.4. SENSOR C: Not used
 - > EXIT
- 1.3. Setting up the Outputs
 - 1.3.1. Number of STAGES = 4
 - 1.3.2. SCHEDULE = NO
 - 1.3.3. OPTIONS
 - 1.3.3.1. RESET = NO, unless outdoor reset sensor connected to controller
 - 1.3.3.2. INTEGRAL = 0 sec.
 - 1.3.3.3. DERIVATIVE = 0 sec.
 - 1.3.3.4. ON DELAY = 0 sec.
 - 1.3.3.5. OFF DELAY = 0 sec.
 - 1.3.3.6. WWSD = NO
 - 1.3.3.8. LEAD LAG = FOFO
 - 1.3.3.9. DI OPTIONS = DISABLE
 - 1.3.3.10. SHOW RT = NO
 - > EXIT

- 1.3.4. Setting up the Stages = Not set
- > EXIT
- 1.4. Setup Alarms = Not set
- > EXIT

PROGRAMMING OPERATING PARAMETERS

PROGRAMMING OUTPUT STAGES WITH NO RESET

- 3.1. Entering Program Mode: Press the MENU button, then select PROGRAM and press the > button to view the Program menu.
 - 3.1.1. SETPOINT = Set value to desired heating loop temperature
 - 3.1.2. THROTTLING RANGE = recommended range 15 – 25°F
 - 3.1.3. SENSOR = Not set
 - 3.1.4. HEAT/COOL = HEAT
 - > EXIT
 - > EXIT

3. Operation

As soon as the selector switch is in the HEATING-position and the thermostat calls for heating:



The HEATING light is lit

The PUMP light is lit

Both lights remain lit as long as the thermostat calls for heating.

Depending on the difference between the programmed set point and the actual temperature in the boiler pressure vessel, the boiler controller will start energizing heating stages.

Boiler Model	Number of Heating Stages:
HLR120	4
HLR150	5
HLR180	6

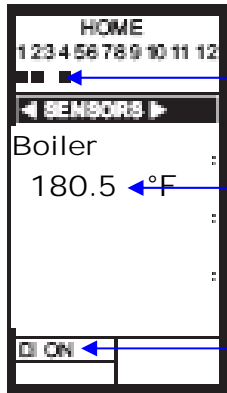

The number of activated heating stages is shown in the upper portion of the display.

The actual temperature of the boiler is shown in the middle portion of the display. To change the set point, please refer to page 29 and page 30 of the attached instruction manual of the Honeywell T775P2003 boiler controller.

Various status messages may be shown in the lower portion of the boiler controller display. As long as the thermostat calls for heating, DI = OFF, when the thermostat does not call for heating, DI = ON.

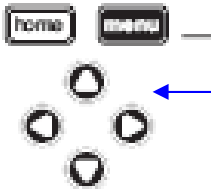

Boiler controller key pad

As soon as the temperature in the pressure vessel approaches the programmed set point temperature, the boiler controller will begin to step out heating stages.

If the actual temperature in the pressure vessel swings for more than 10% over the programmed set point, the settings of the Honeywell T775P2003 boiler controller must be optimized, otherwise the temperature safety limit controls may trip. Optimizing the controller settings can be achieved by performing the following steps:

- The Honeywell T775P2003 boiler controller has a PID-control algorithm build in. It is factory preset to operate with proportional component only. The integrating and derivative components are set to 0. This provides the easiest point to start to optimize the response of the controller to the temperature in the heating loop. As long as only the proportional component is active, the boiler controller de-energizes the second last heating step when the controller sensor reads exactly the temperature set point. The temperature at which the last heating step gets de-energized = set point + throttling range/number of programmed heating steps. As an example: if the boiler controller set point is set to 180°F, the throttling range set to 20°F/4 and 4 heating steps programmed, then the last heating step will get de-energized at $180^{\circ}\text{F} + 20^{\circ}\text{F}/4 = 185^{\circ}\text{F}$. If the temperature in this example should never go above 180°F, then the set point should actually be set to 175°F.

- Increase the throttling range until the boiler temperature does not swing more than 5% over the target temperature.

- If the boiler temperature does not reach the set point when the boiler operates under high load, then slowly, step by step increase the integrating component in the controller. Do not use the derivative component.

Please refer to the instruction manual of the Honeywell T775P2003 boiler controller for setting the set point, throttling range and integrating component.

Safety Limit Controls:

High Temperature Limit Controls

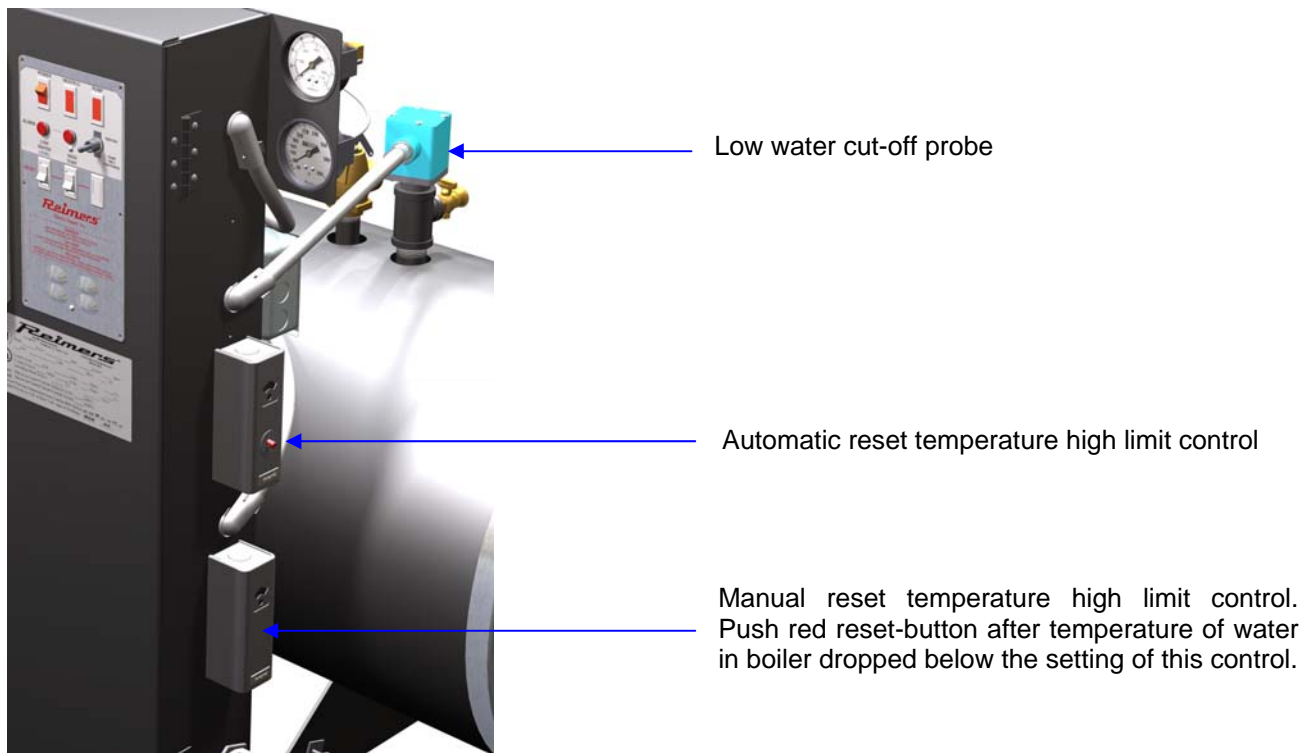

Each boiler is equipped with two high limit temperature safety limit controls: One automatic reset control, set to a lower cut-off temperature and one manual reset control, set to a higher cut-off temperature. If the automatic reset control trips, the HEATING light on the front panel of the boiler controller turns off and all heating stages turn off immediately. If the manual reset control trips, then the HEATING light on the front panel of the boiler controller turns off, the HIGH TEMPERATURE alarm light will turn on and all heating stages turn off immediately.

Low Water Cut-Off Limit Control

Each hot water boiler is equipped with a low water cut-off control. If the water level in the boiler drops to a level below the tip of the low water cut-off probe, the HEATING light turns off, the LOW WATER alarm light on the front panel of the boiler controller turns on and all heating stages turn off immediately.

The water level in the boiler must be restored to its nominal level before the LOW WATER alarm can be reset. To reset this alarm, press the LOW WATER reset switch on the front panel of the boiler controller.

4. Trouble Shooting

Boiler Status	Quick Fix
Control voltage to boiler turned on, power switch on boiler control (5) turned on, but no lights lit on the front panel of the boiler control:	<ul style="list-style-type: none">- Check circuit breaker or fuse of the wall outlet where the boiler control voltage circuit is hooked up to. If the circuit breaker is tripped or the fuse blown, check whether other appliances are plugged into outlets that are fed by the same circuit breaker/fuse. If that is the case, then plug those other appliances into outlets that are protected by other circuit breakers or fuses.
"Low Water" alarm light on boiler control panel (5) lit:	<ul style="list-style-type: none">- Press the "Low Water" reset button. If the "LOW WATER" alarm light remains on, then check the water supply of the system.
"HIGH TEMPERATURE" alarm light on boiler control panel (5) lit:	<ul style="list-style-type: none">- Press the "High TEMPERATURE" reset switch- If the temperature gauge indicates water temperature above the preset value, reduce water temperature setting and press the "HIGH TEMPERATURE" reset switch again.

If trouble shooting did not resolve problem, please contact our service technicians at:

Phone: 540-662-3811

Email: sales@reimersinc.com

LIVECHAT www.reimersinc.com

5. Parts List for Reimers Electra Steam, Inc. Hot Water Boilers

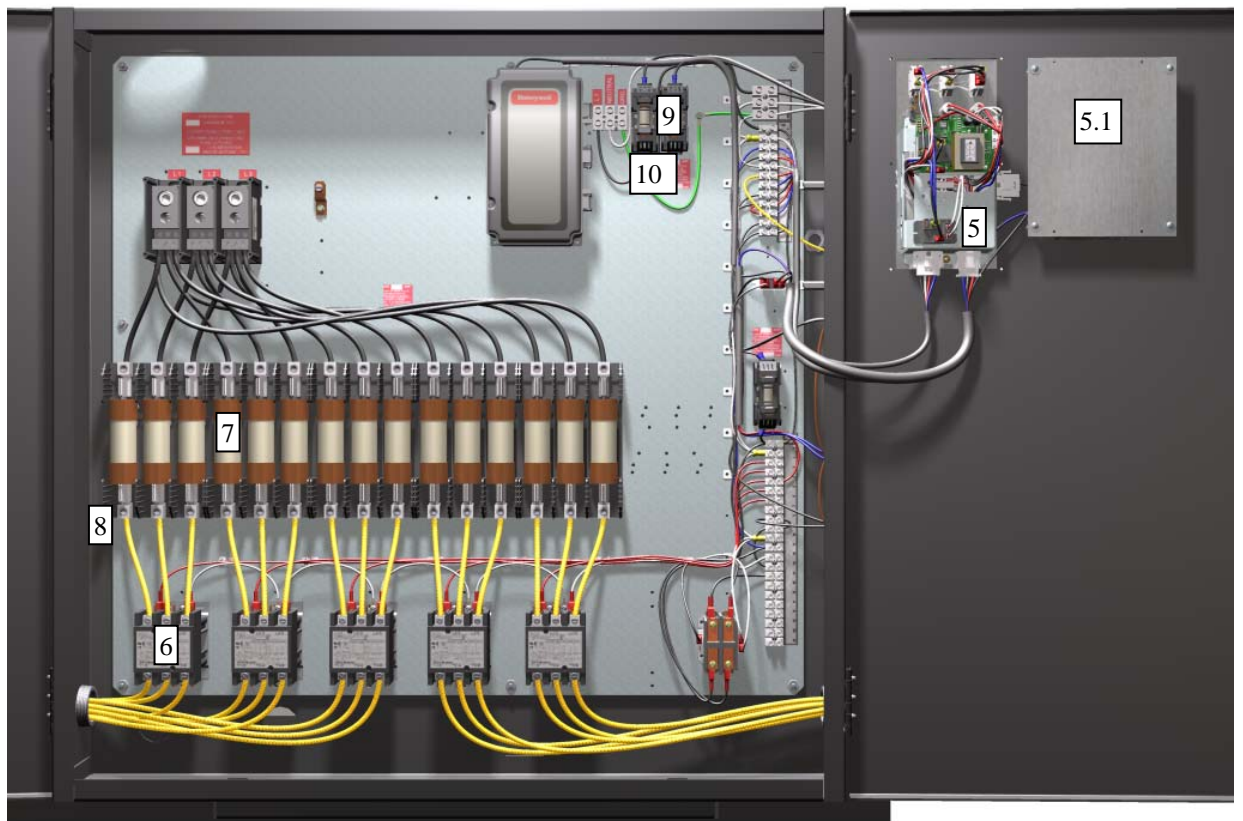
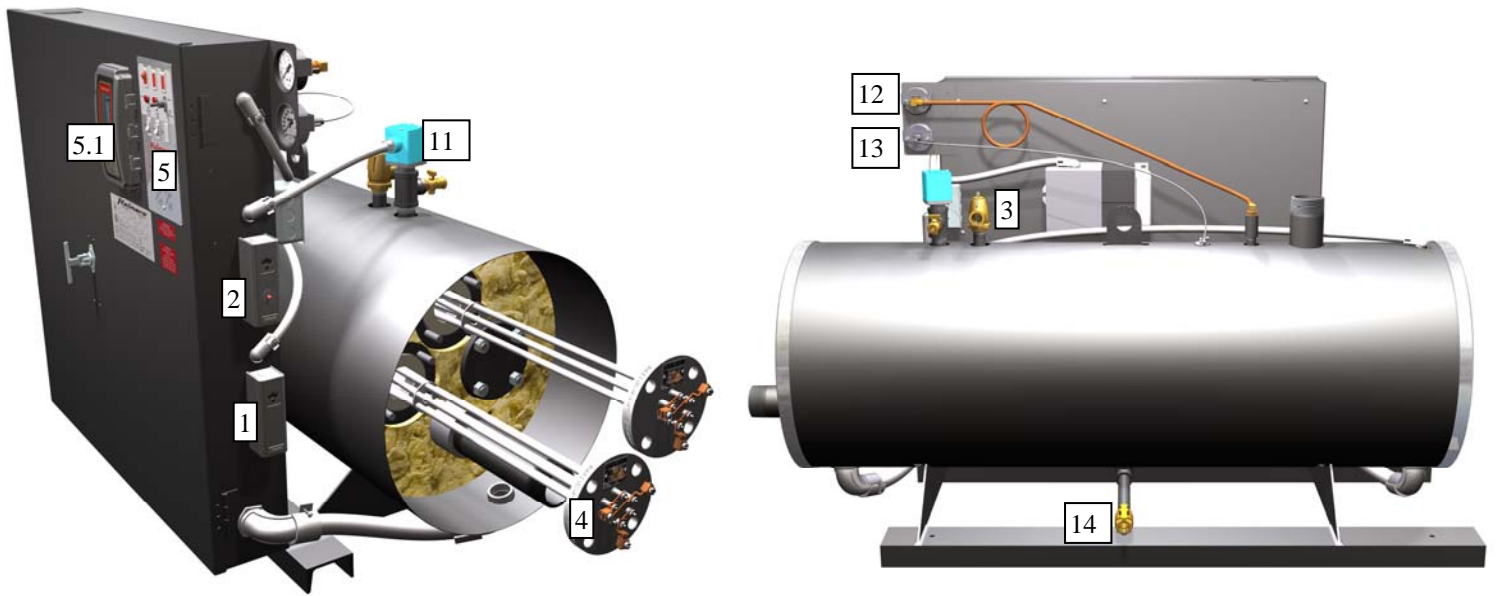

NOTE: When ordering parts give boiler Model and Serial Number and detail shipping instructions.

ITEM NO.	PART NO.	DESCRIPTION	BOILER MODEL
1	02378	TEMPERATURE CONTROL AUTO RECYCLE 100 – 240°F	ALL MODELS
2	02599	TEMPERATURE CONTROL W/MANUAL RESET	ALL MODELS
3	02657	VALVE SAFETY 0.75", 100psi HOT WATER	NOTE2
	02384	VALVE SAFETY 0.75", 30psi HOT WATER	NOTE2
	02706	VALVE SAFETY 0.75", 60psi HOT WATER	NOTE2
	02641	VALVE SAFETY 0.75", 75psi HOT WATER	NOTE2
4	02608	HEATING ELEMENT 30kW, 240V	NOTE 1
	03267	HEATING ELEMENT 30kW, 380V	NOTE 1
	02609	HEATING ELEMENT 30kW, 480V	NOTE 1
	02610	HEATING ELEMENT 30Kw, 600V	NOTE 1
	02022	ELEMENT FLANGE GASKET 2" RING	ALL MODELS
5	20721-HLR	ELECTRONIC BOILER CONTROL	ALL MODELS
5.1	05012	ELECTRONIC BOILER & STEP CONTROLLER	ALL MODELS
6	02530	HEATING ELEMENT CONTACTOR 50A 120V 3PH	NOTE 2
	02539	HEATING ELEMENT CONTACTOR 75A 120V 3PH	NOTE 2
	02597	HEATING ELEMENT CONTACTOR 93A 120V 3PH	NOTE 2
7	02656	FUSE 90A, 250V	NOTE 2
	02518	FUSE 40A, 600V	NOTE 2
	02135	FUSE 50A, 600V	NOTE 2
	02136	FUSE 60A, 600V	NOTE 2
8	02144	HEATING ELEMENT FUSE BLOCK 250V, 100A	NOTE 2
	02614	HEATING ELEMENT FUSE BLOCK 600V, 60A	NOTE 2
9	02125	CONTROL CIRCUIT FUSE 250V 15A UL/CSA	ALL MODELS
10	02140	CONTROL CIRCUIT FUSE BLOCK	ALL MODELS
11	02630	ELECTRODE PROBE FITTING	ALL MODELS
12	02569	PRESSURE GAUGE	ALL MODELS
13	02567	TEMPERATURE GAUGE	ALL MODELS
14	03802	DRAIN VALVE 0.75"	ALL MODELS

NOTE 1 – When ordering, specify voltage (V) and power (kW) of element.

NOTE 2 – When ordering, specify model number of part.