

CE 0038 [P > 0.5 BAR]

elfab
pressure intelligence



- Installation (GB)
- Installation (F)
- Einbauanleitung (D)
- Installazione (I)
- Instalatie (NL)
- Instalação (P)
- Instalacion (E)
- Instalation (S)
- Установка (RU)

Two Way Arma-Gard™
(AGS/2WD – AGS/2WS)

Elfab Limited
Alder Road, North Shields, Tyne and Wear, NE29 8SD
UNITED KINGDOM
e-mail: sales@elfab.com. www.elfab.com
Tel: +44(0)1912931234

Elfab China Chinasales@elfab.com
Elfab Poland Polandsales@elfab.com
Elfab Singapore Singaporesales@elfab.com

1

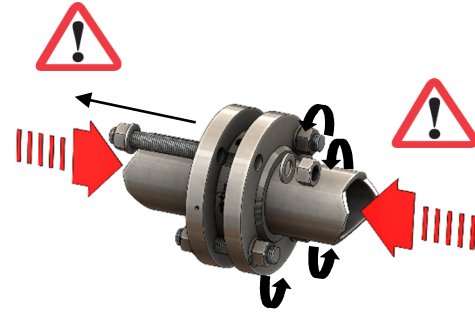

2

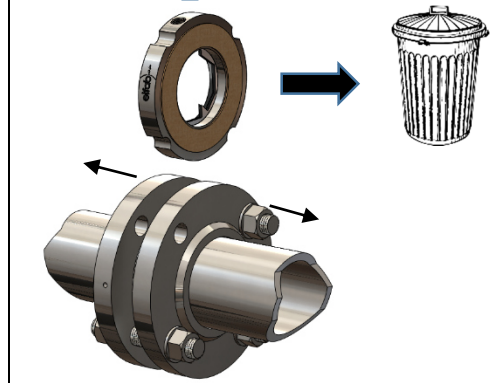

3

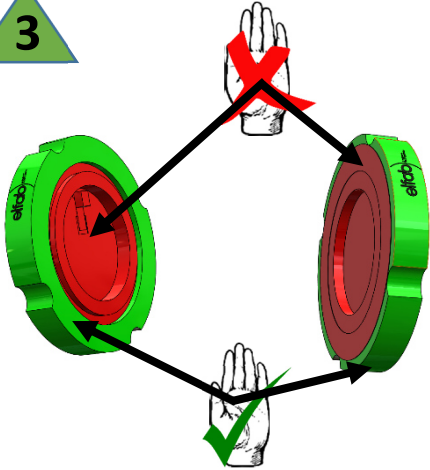

4

- | | |
|---|---|
| (GB) Do not use if damaged | (P) Não usar se avariado |
| (F) Ne pas utiliser si endommagé | (E) No utilize en caso de que este dañado |
| (D) Niemals beschädigte berstscheibe einbauen | (S) För ej användas, om det är skadat |
| (I) Non utilizzare se danneggiato | (RU) Не пользоваться при повреждениях |
| (NL) Indien beschadigd niet gebruiken | |

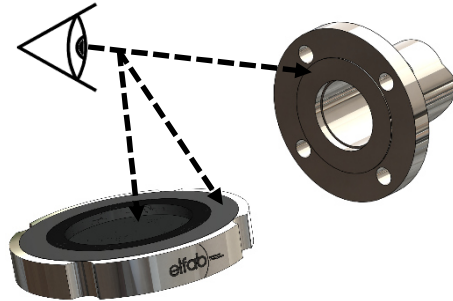

5

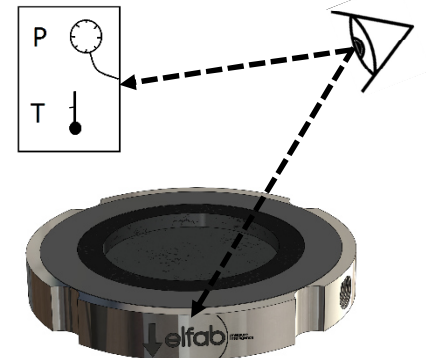

6

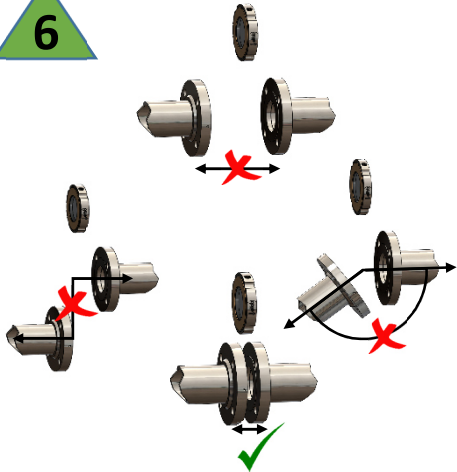

7

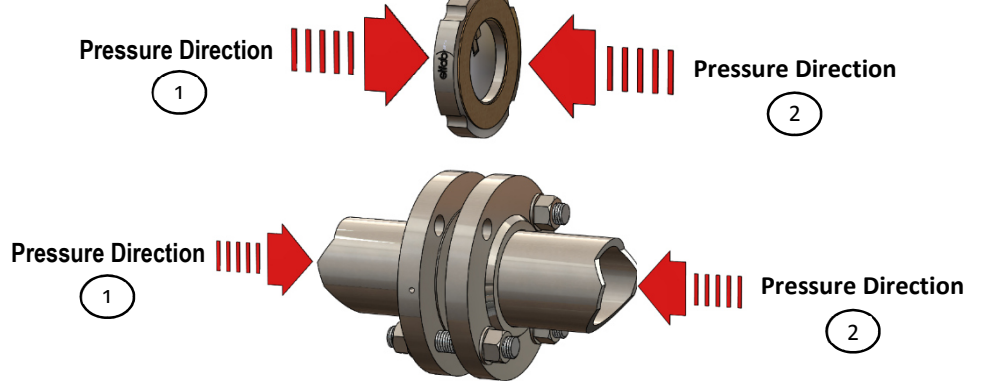

8

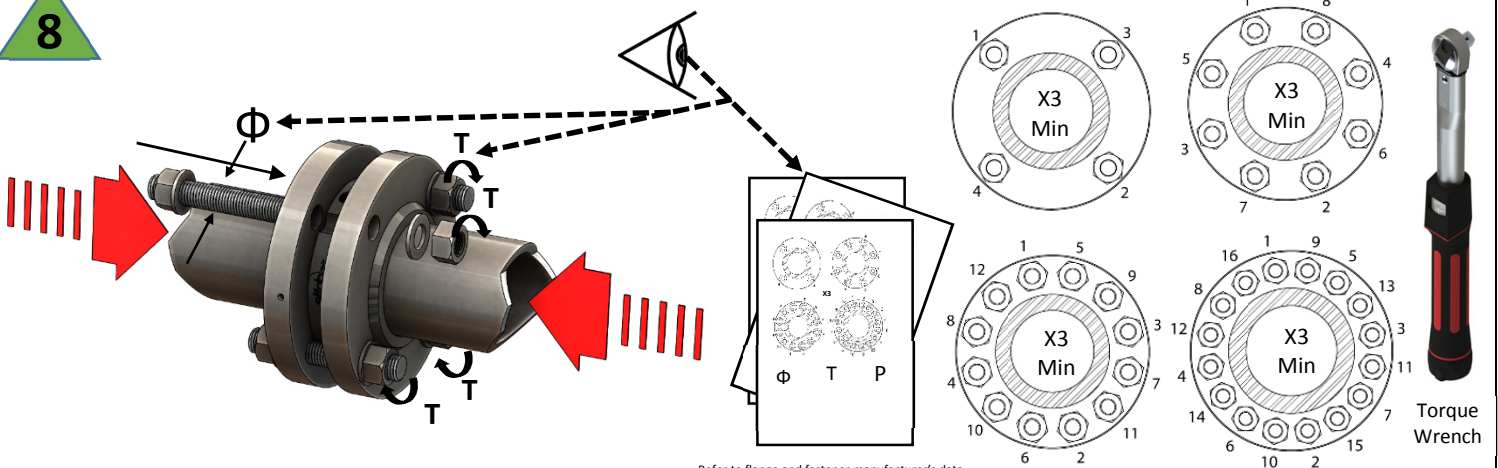

Refer to flange and fastener manufacturer's data.