



GUANGZHOU SHINING(ZN) PLASTIC BUILDING MATERIALS CO.,LTD

WALL PROTECTION
NEW MODEL AND FASHION STYLE

Tel:020-8359 5492

Mobile:+86 181 2677 4598

E-mail:alplastic@163.com

Website:www.wallprotection.cn

Address:Room 403, Building A, No. 1, Longzhu Road, Huangbei, Huangpu District, Guangzhou

ANTI-COLLISION SERIES

CONTENTS

01
HANDRAIL



02
WALL GUARD

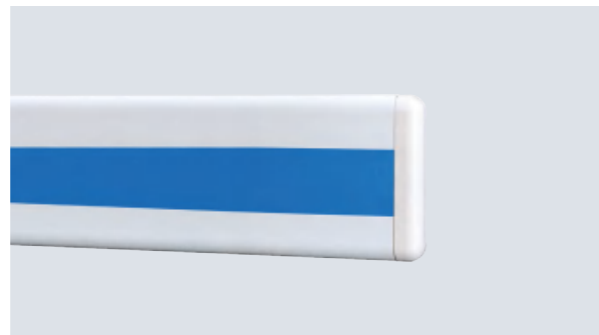

03
VINYL WALL SHEET

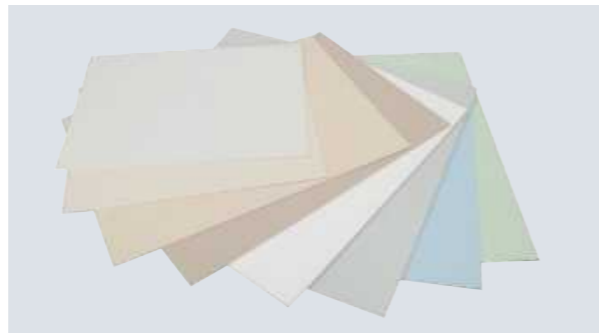

04
CORNER GUARD



FEATURES:

High strength with metal structure, warm vinyl surface. Protect wall from hitting and providing pedestrians with convenience.
38 color to choose, making perfect color space.
Scope of application: corridor, Stair railing etc.



ZXY-140

Flame retardant/
antibacterial/anti-
collision

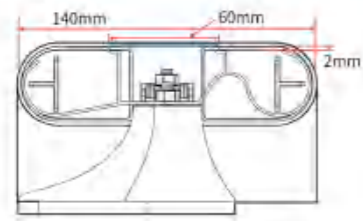

ZXY-140

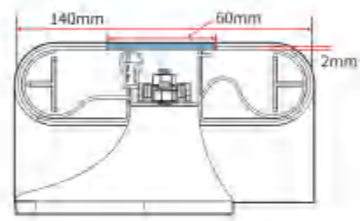

ZXY-140R

Model	Material	Aluminum Thickness	Size	Color
ZXY-140	PVC panel+aluminum	1.2/1.4/1.6/1.8/2.0mm	4000*140mm	varied

STYLE DISPLAY

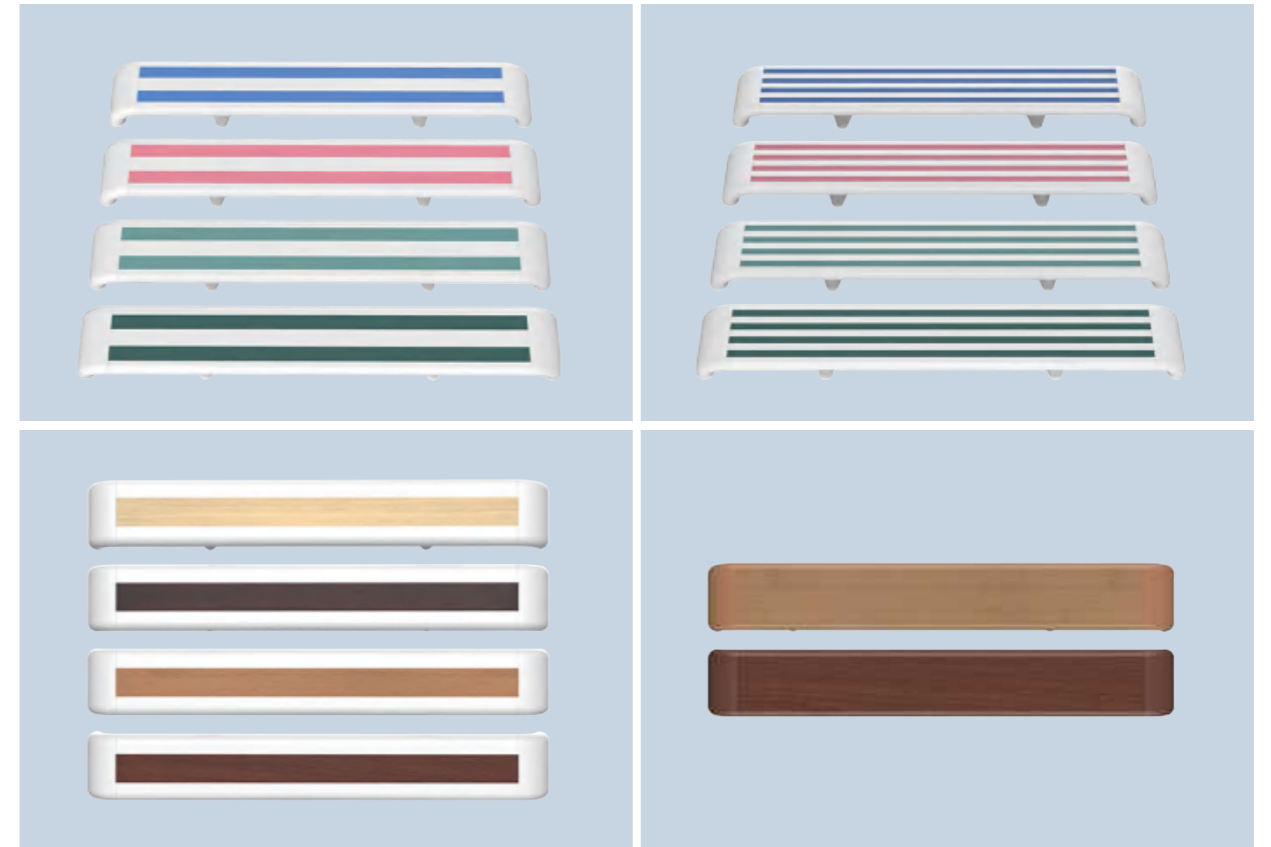

SCENE DISPLAY



ZXY-159

Flame retardant/
antibacterial/anti-
collision

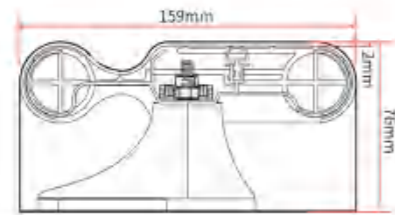

ZXY- 159R

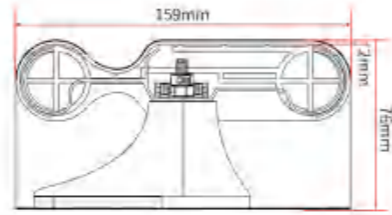

ZXY- 159

Model	Material	Aluminum Thickness	Size	Color
ZXY- 159	PVC panel+aluminum	1.2/1.4/1.6/1.8/2.0mm	4000*140mm	varied

STYLE DISPLAY

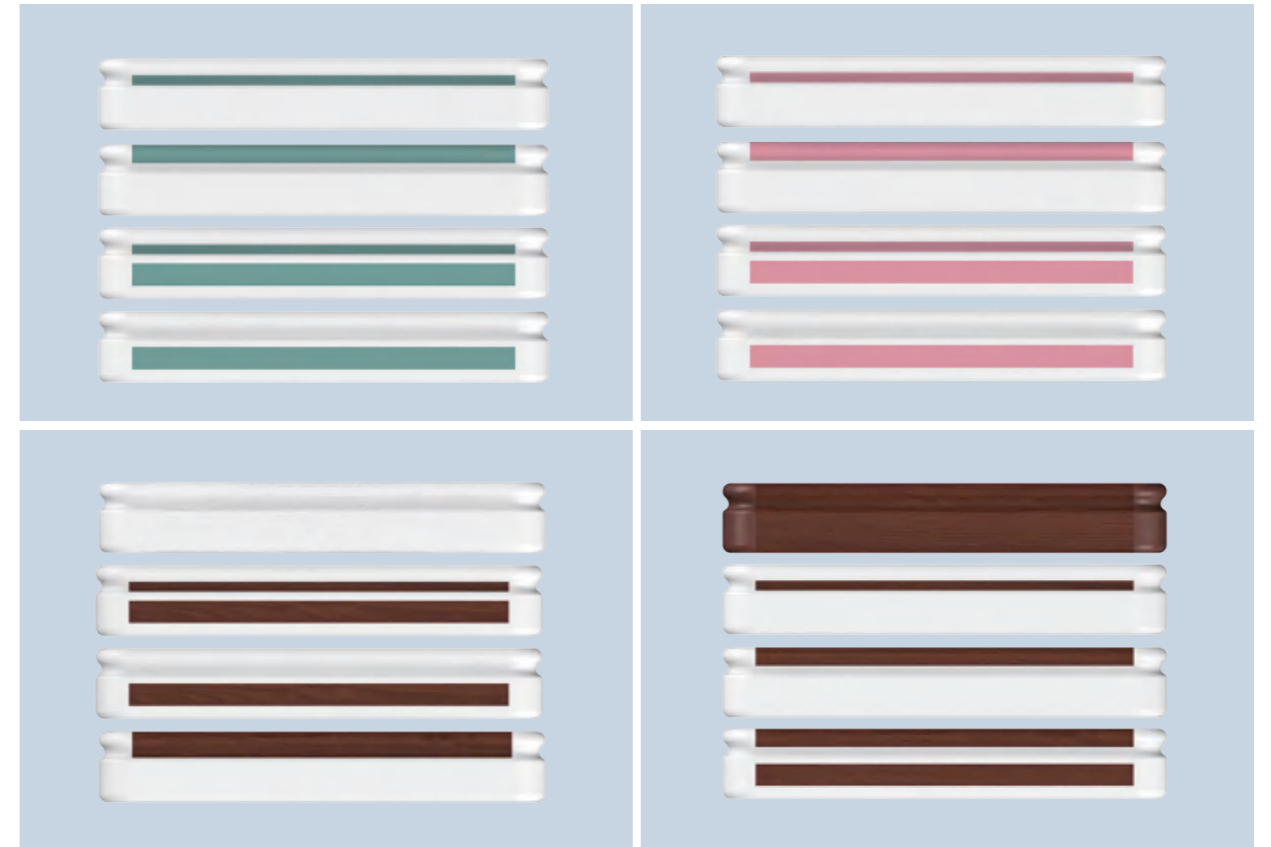

SCENE DISPLAY



ZXY-143

Western European mainstream style
Complex process and elegant shape

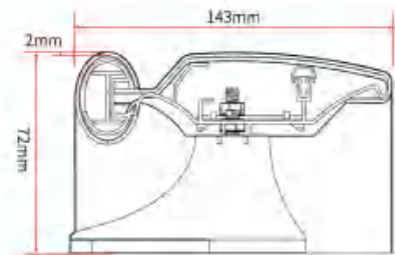

ZXY-143R

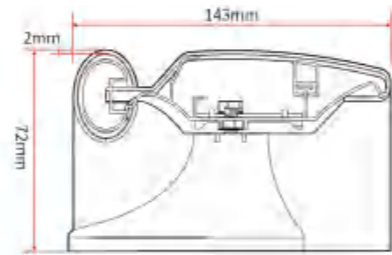

ZXY-143

Model	Material	Aluminum Thickness	Size	Color
ZXY-143	PVC panel+aluminum	1.4/1.6/1.8mm	4000*143mm	varied

STYLE DISPLAY

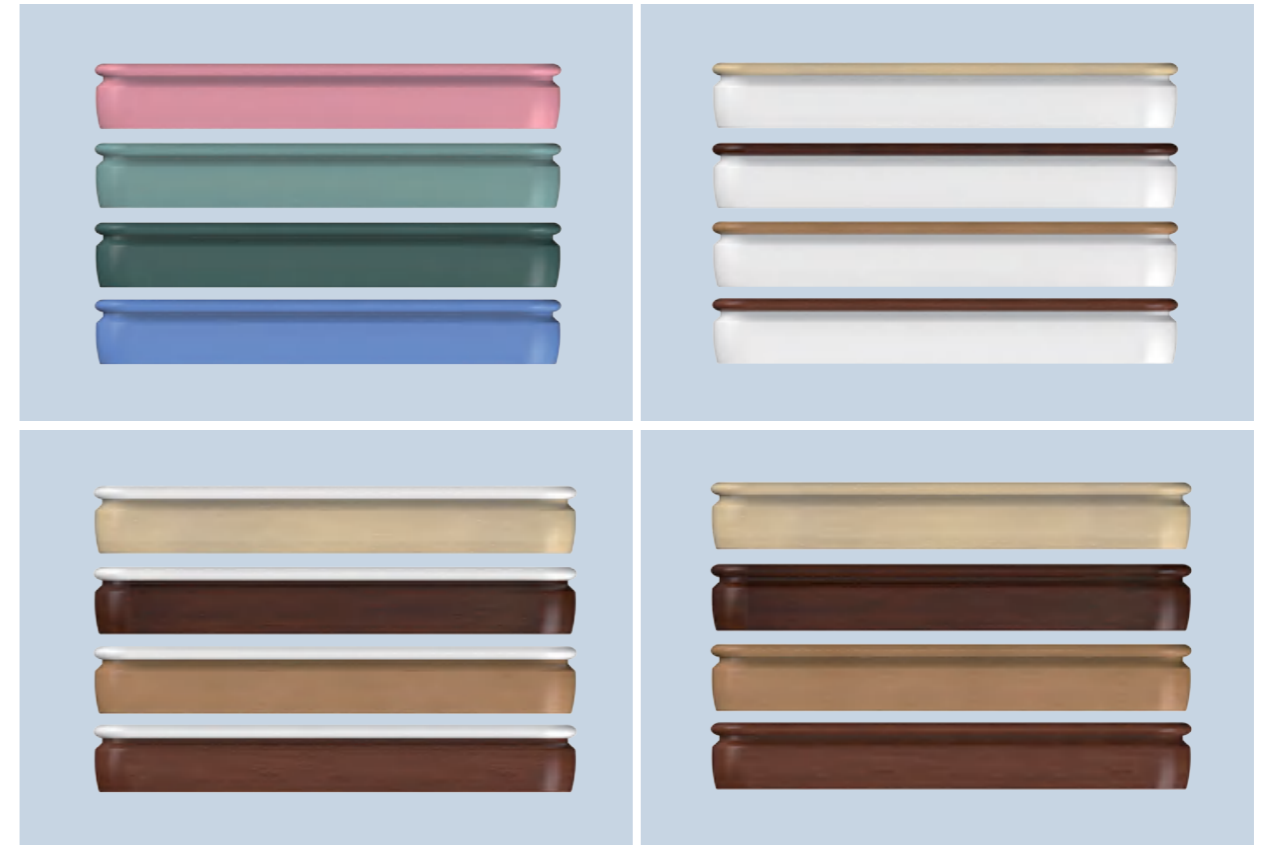
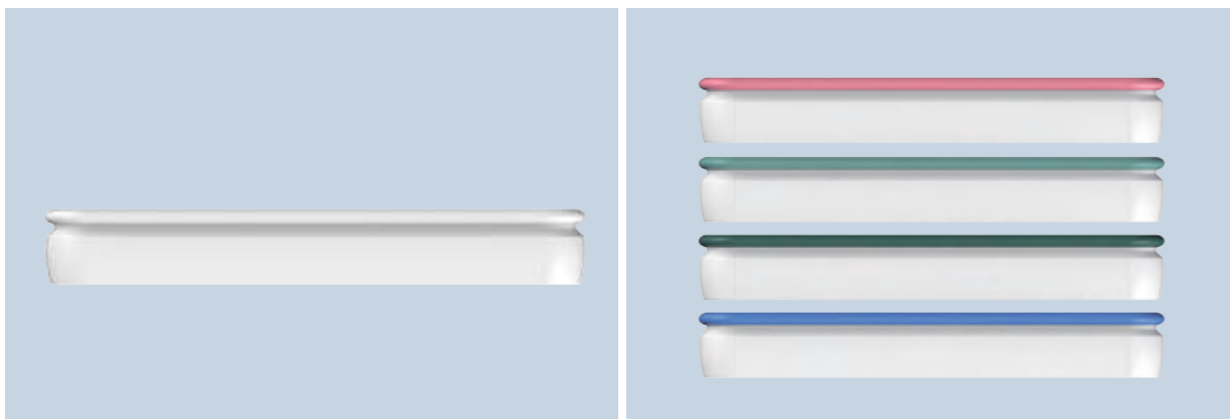

SCENE DISPLAY



ZXY-89R

Fashionable appearance and various colors
More humanized structure design

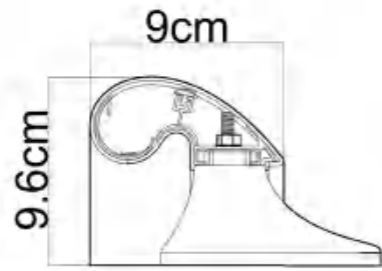

ZXY-89R

Model	Material	Aluminum Thickness	Size	Color
ZXY-89R	PVC panel+aluminum	1.2/1.4/1.6mm	4000*90mm	varied

STYLE DISPLAY

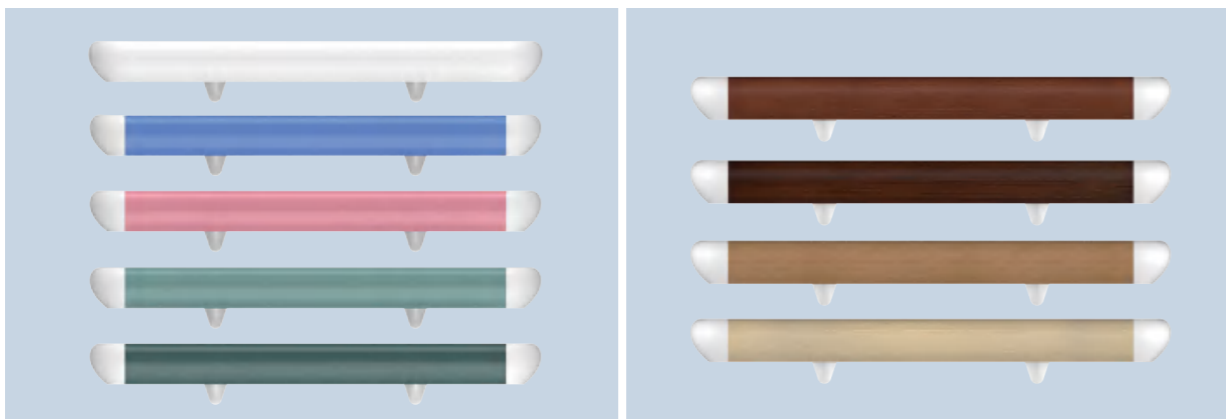

SCENE DISPLAY



ZXY-38

38 Golden ratio
More comfortable
to hold

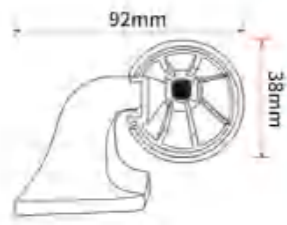

ZXY-38



ZXY-38C

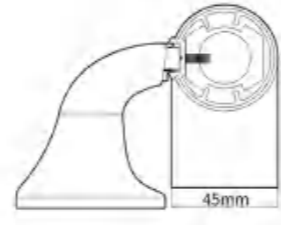

ZXY-38-45

Model	Material	Aluminum Thickness	Size	Color
ZXY-38	PVC panel+aluminum	1.6/1.8/2.0mm	4000*38/45	varied

STYLE DISPLAY

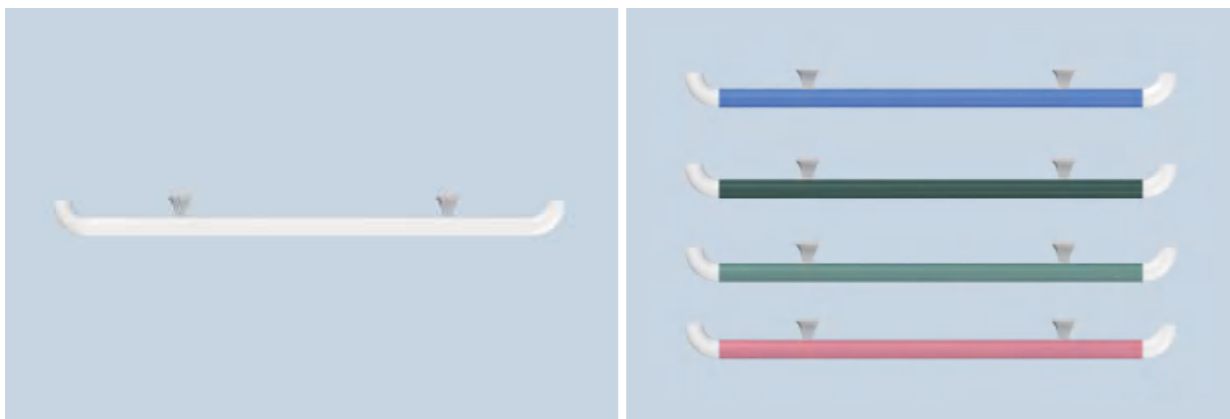

SCENE DISPLAY



ZXY-200

New Design
Combination Handrail

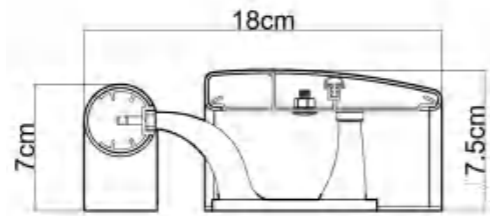

ZXY- 200

Model	Material	Aluminum Thickness	Size	Color
ZXY- 200	PVC panel+aluminum	1.6mm	4000*180mm	varied

STYLE DISPLAY

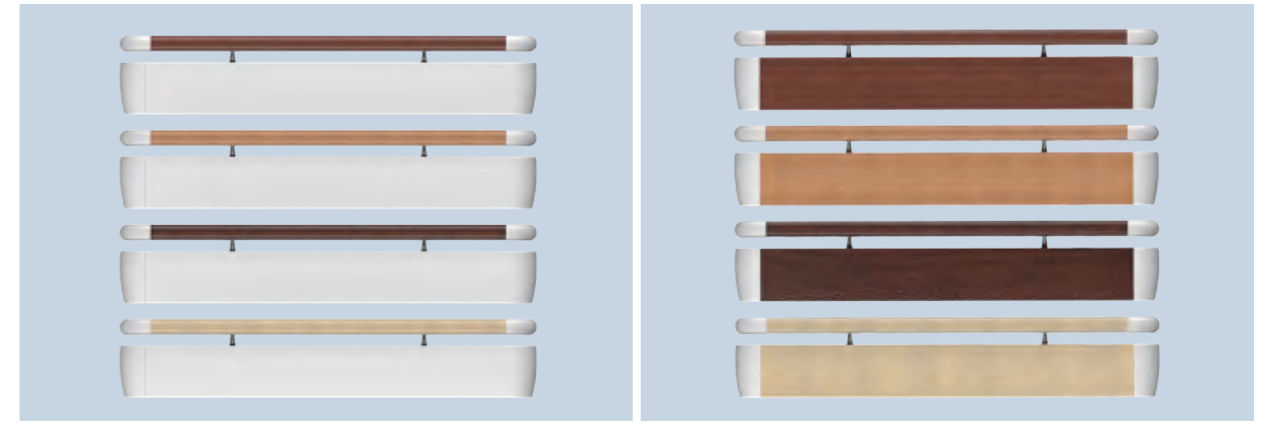

SCENE DISPLAY



ZXY-39C

Holding position and structure
Maximize the palm holding habit

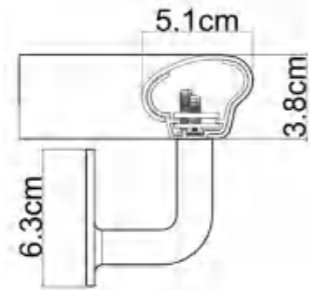
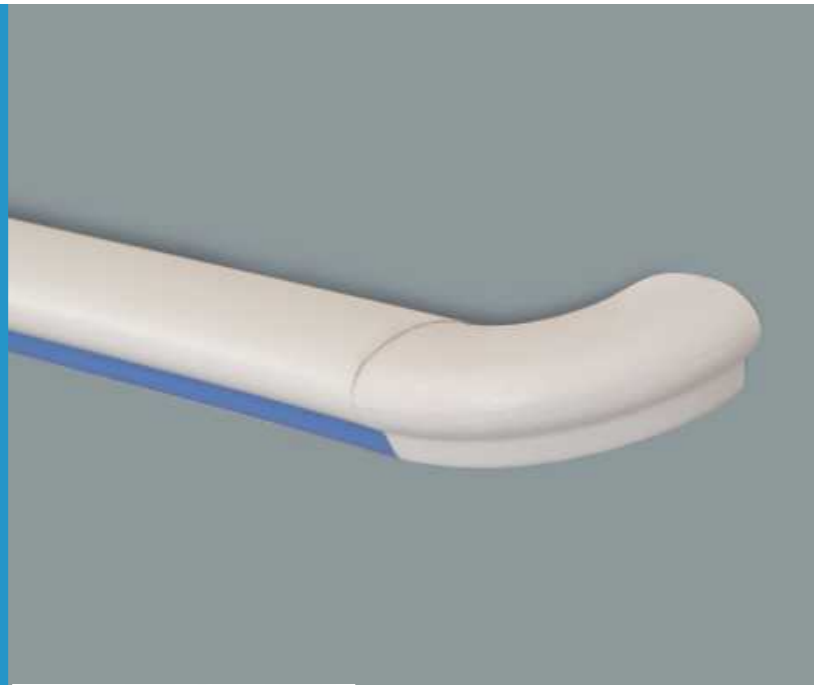

ZXY-39C

Model	Material	Aluminum Thickness	Size	Color
ZXY-39C	PVC panel+aluminum	1.7mm	4000*38mm	varied

STYLE DISPLAY

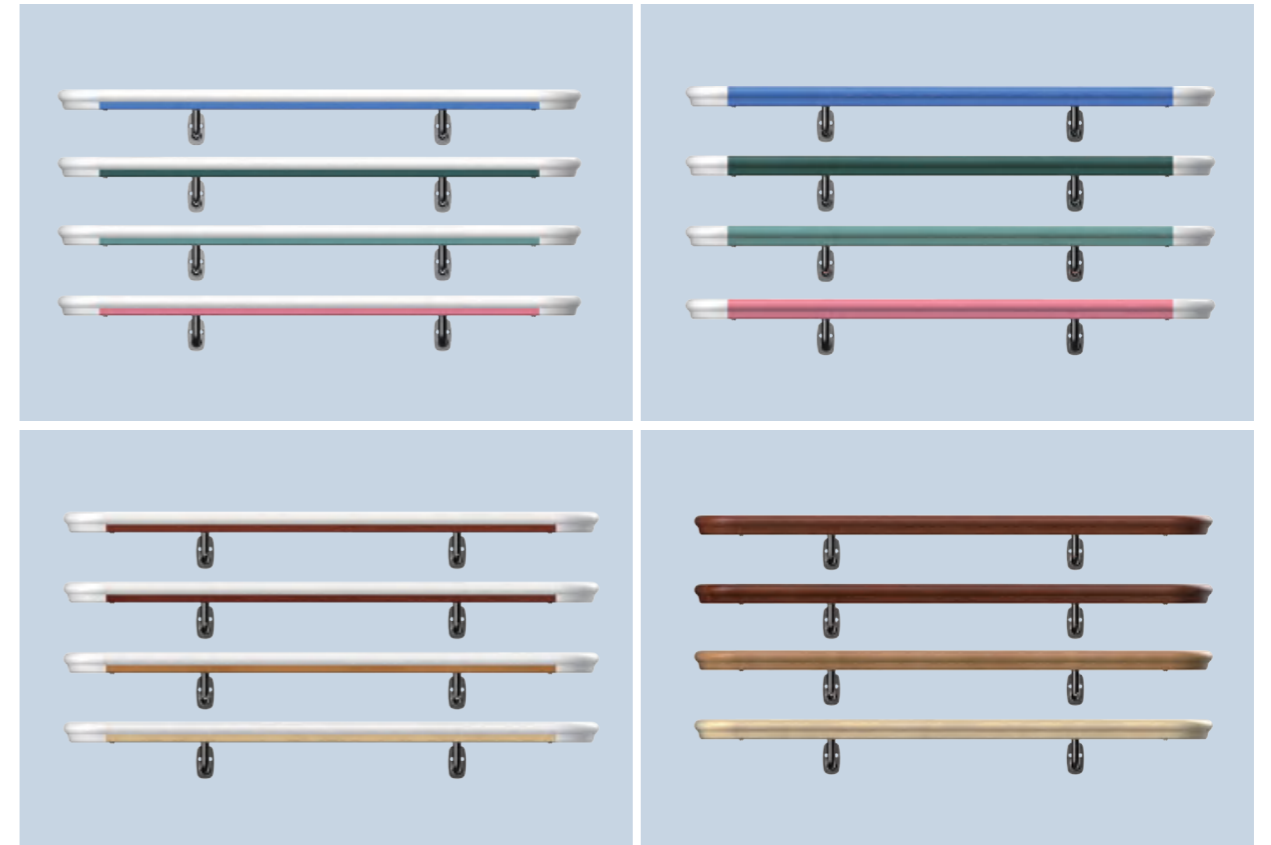
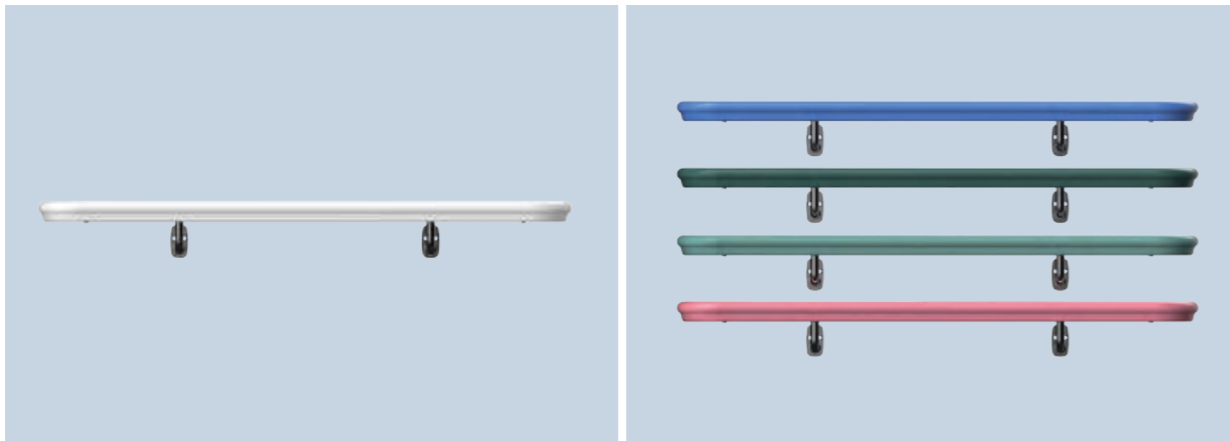

SCENE DISPLAY



ZXY-145A

Double groove
streamline
modeling
No resistance,
softer

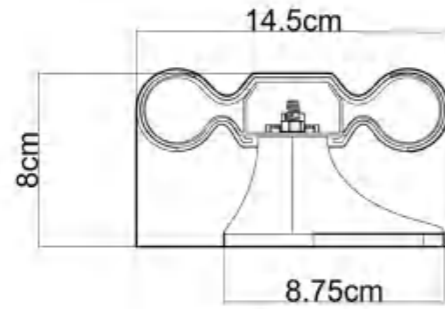

ZXY-145A

Model	Material	Aluminum Thickness	Size	Color
ZXY-145A	PVC panel+aluminum	1.4mm	4000*145	varied

STYLE DISPLAY

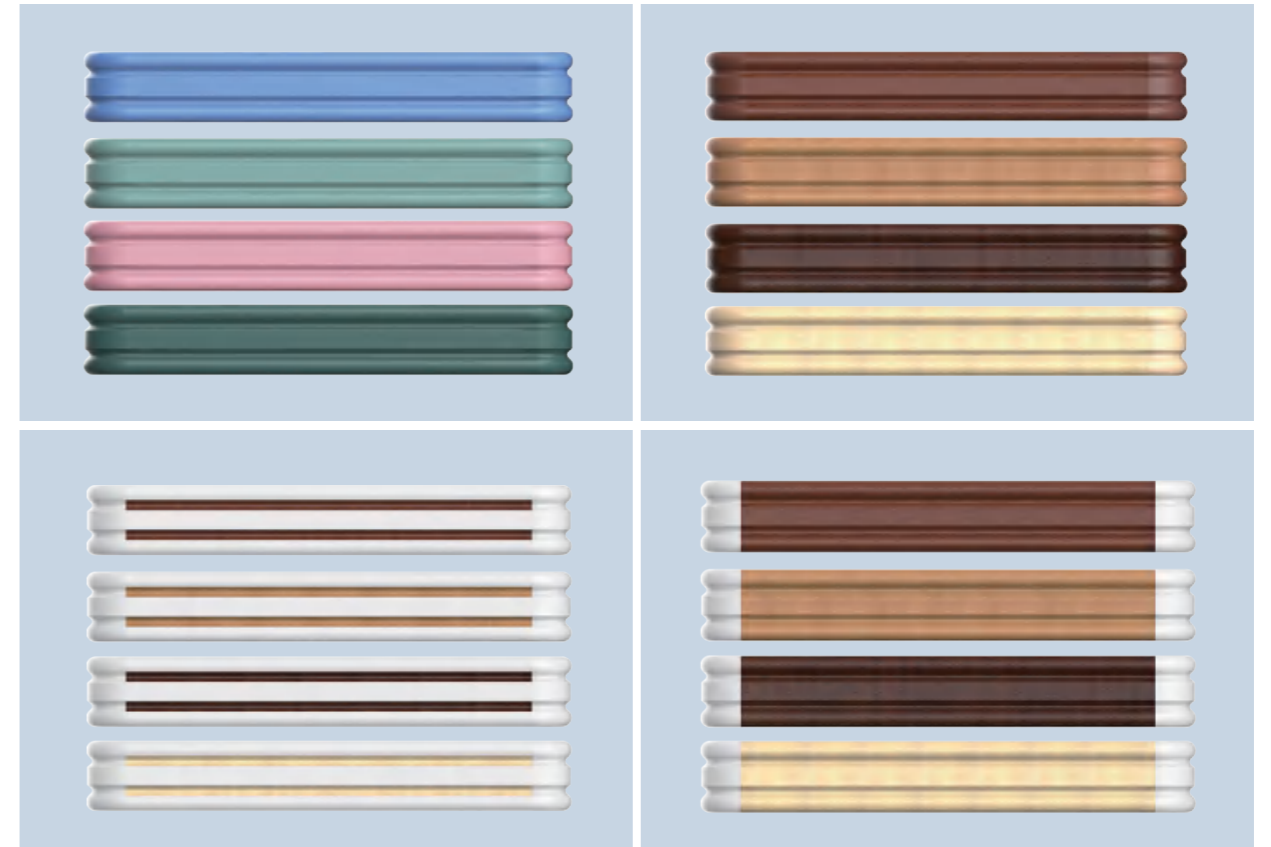
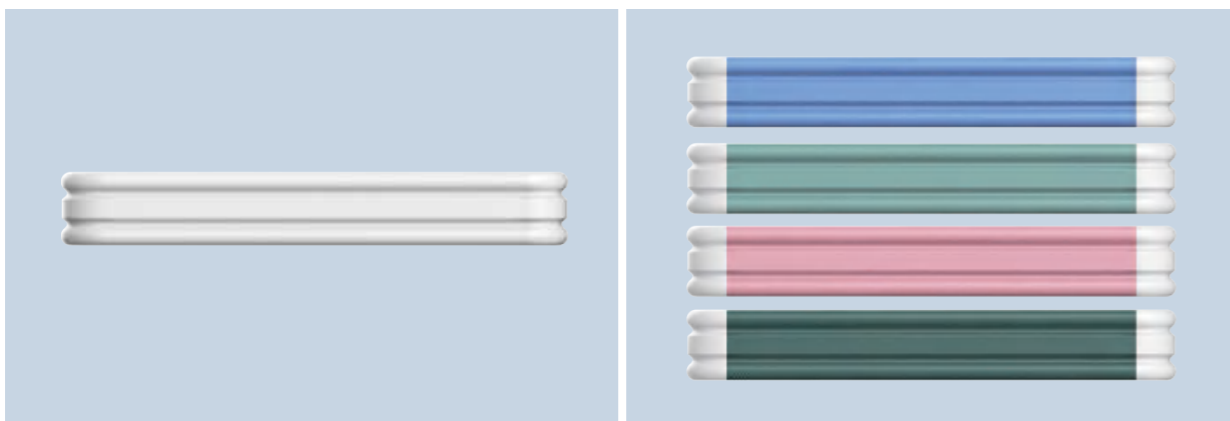

SCENE DISPLAY



ZXY-140A

Appearance arc modeling
More hand fitting
Excellent grip

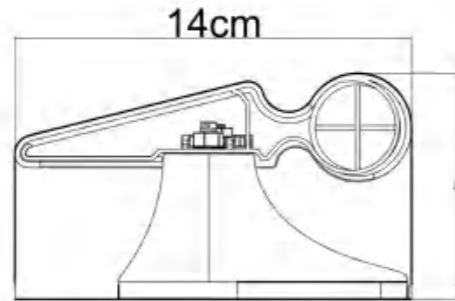

ZXY-140A

Model	Material	Aluminum Thickness	Size	Color
ZXY-140A	PVC panel+aluminum	1.4/2.0mm	4000*140mm	varied

STYLE DISPLAY

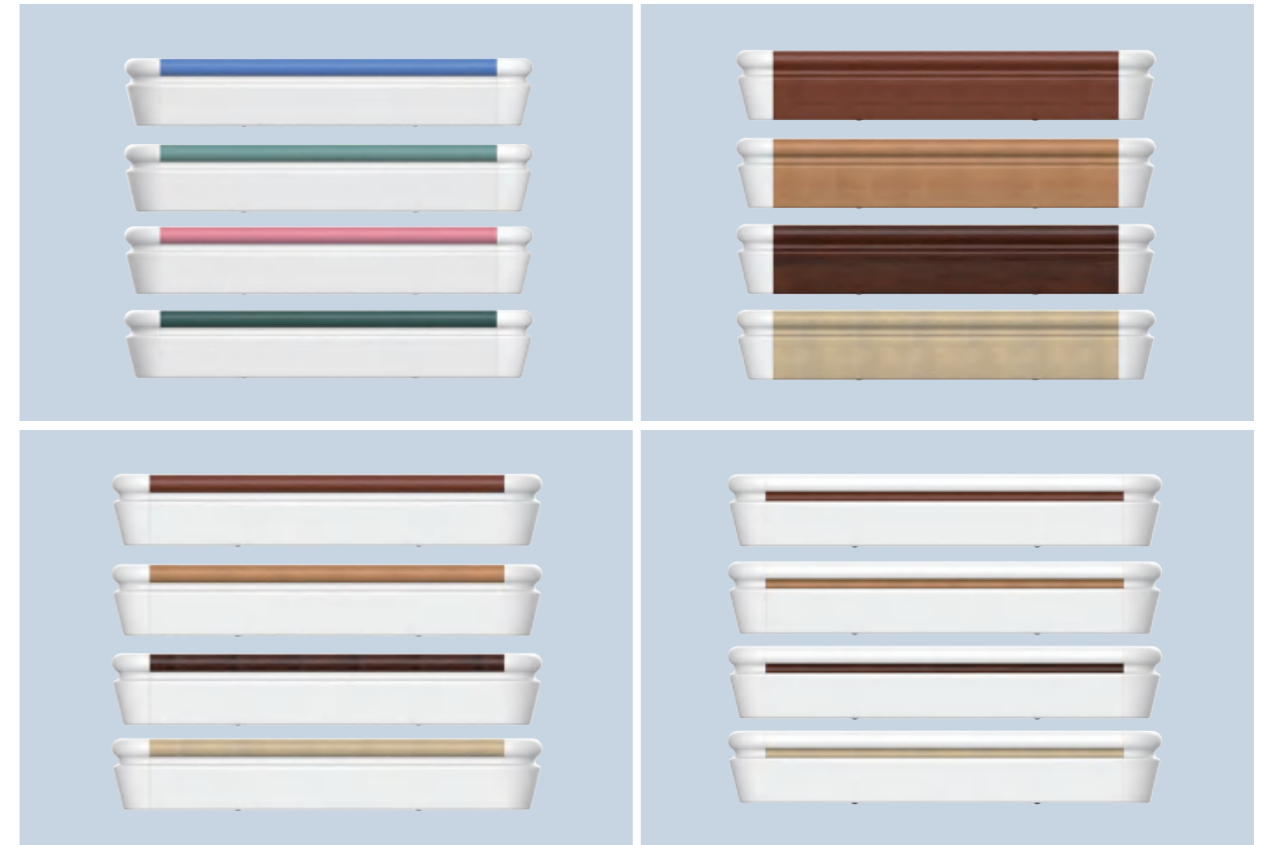

SCENE DISPLAY



ZXY-141

Multi skill peak
Create extraordinary
visual impact

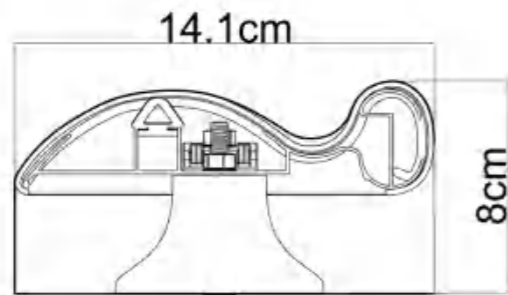
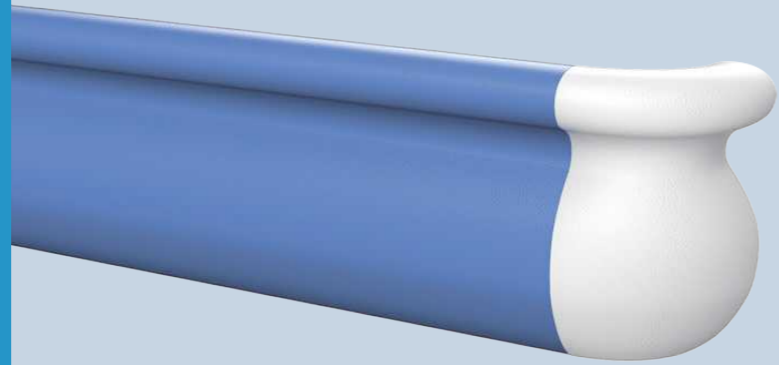

ZXY-141

Model	Material	Aluminum Thickness	Size	Color
ZXY-141	PVC panel+aluminum	1.2/1.6mm	4000*141mm	varied

STYLE DISPLAY

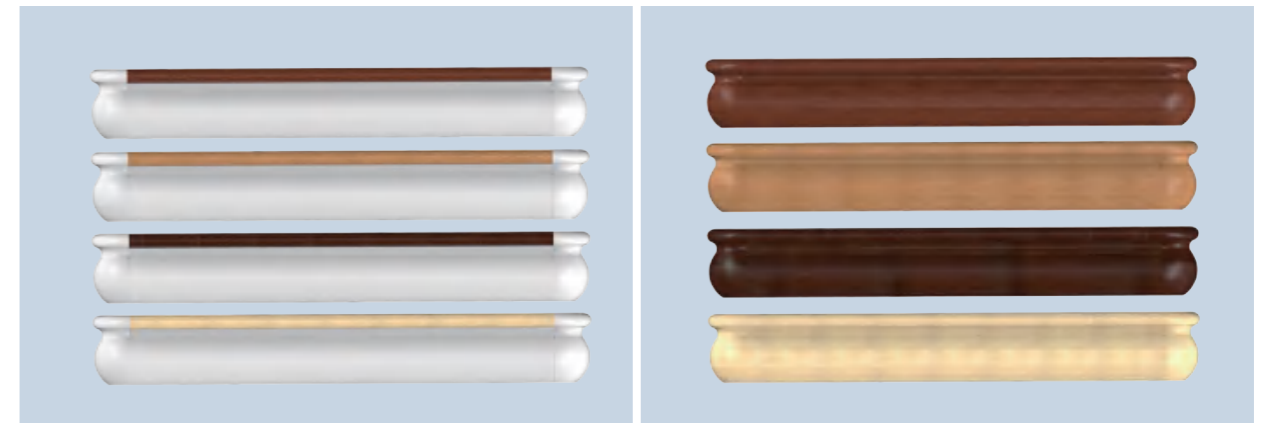
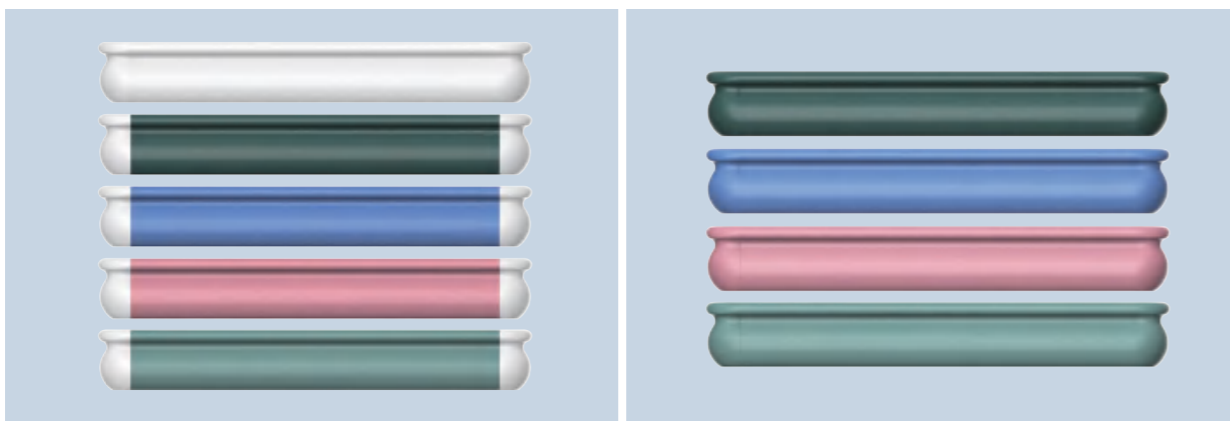

SCENE DISPLAY



ZXY-38A

Cold top process
Ergonomic design



3.8cm

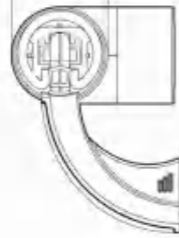

ZXY-38A

Model	Material	Aluminum Thickness	Size	Color
ZXY-38A	PVC panel+aluminum	2.3mm	4000*38mm	varied

STYLE DISPLAY

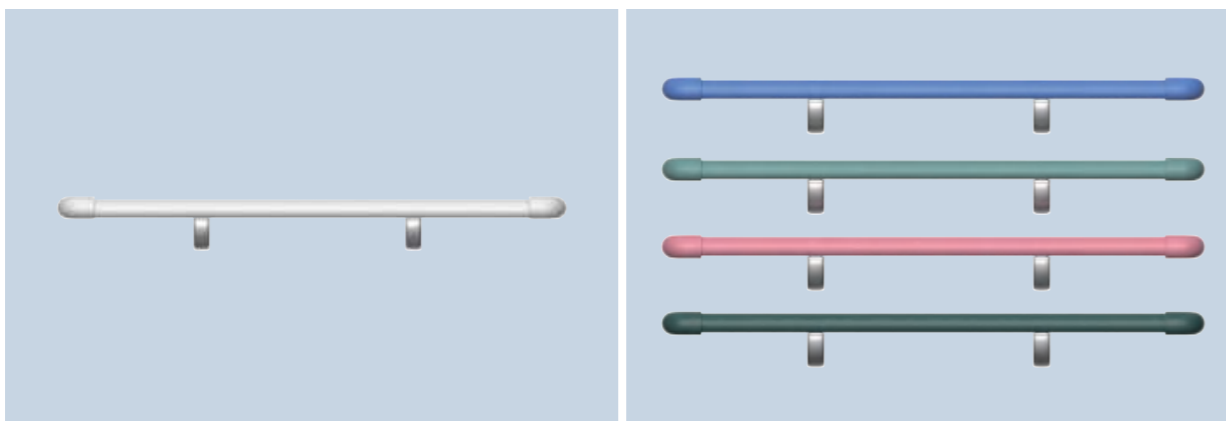

SCENE DISPLAY

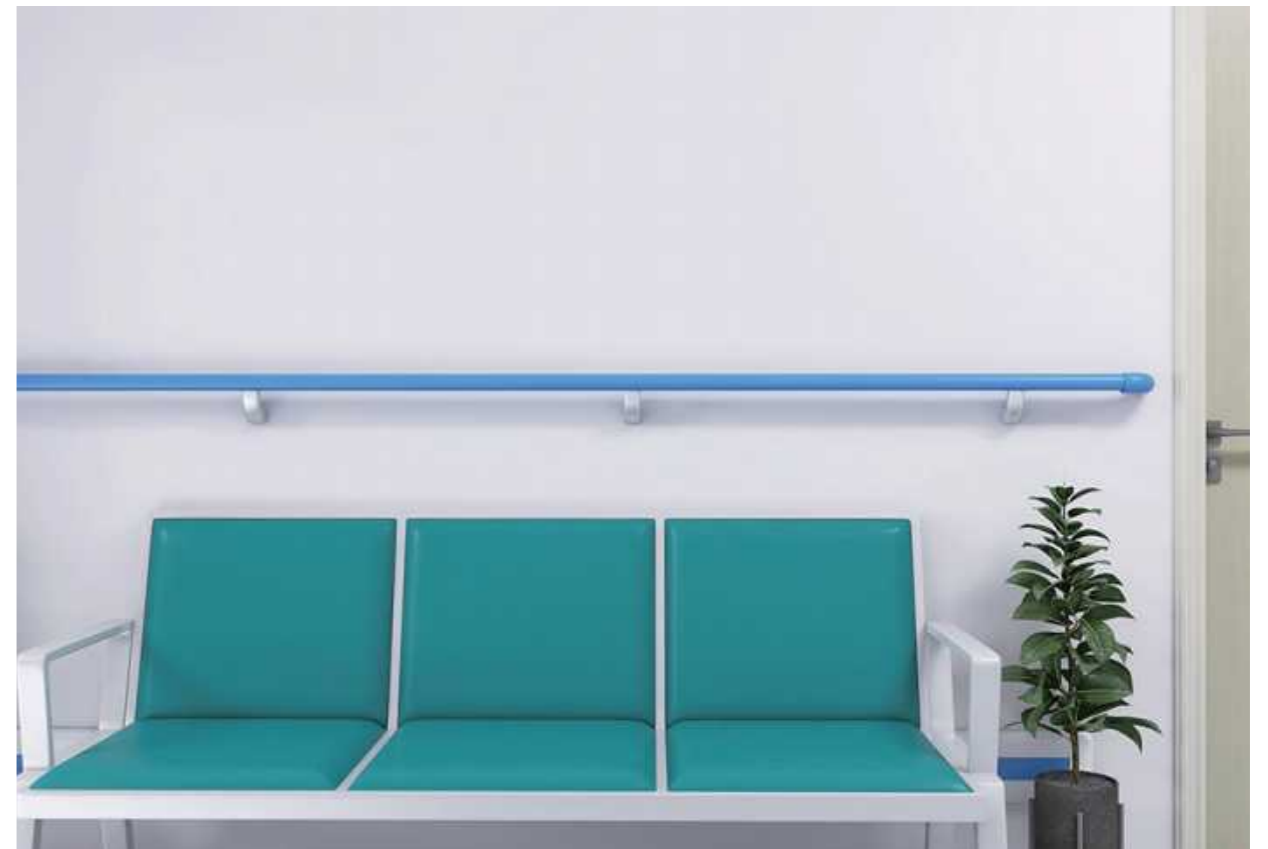

ZXY-72

PVC panel superfine resin, exquisite technology
Unique and elegant

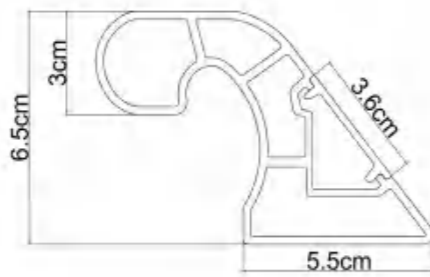

ZXY-72

Model	Material	Size	Color
ZXY-72	PVC panel	4000*65mm	varied

STYLE DISPLAY

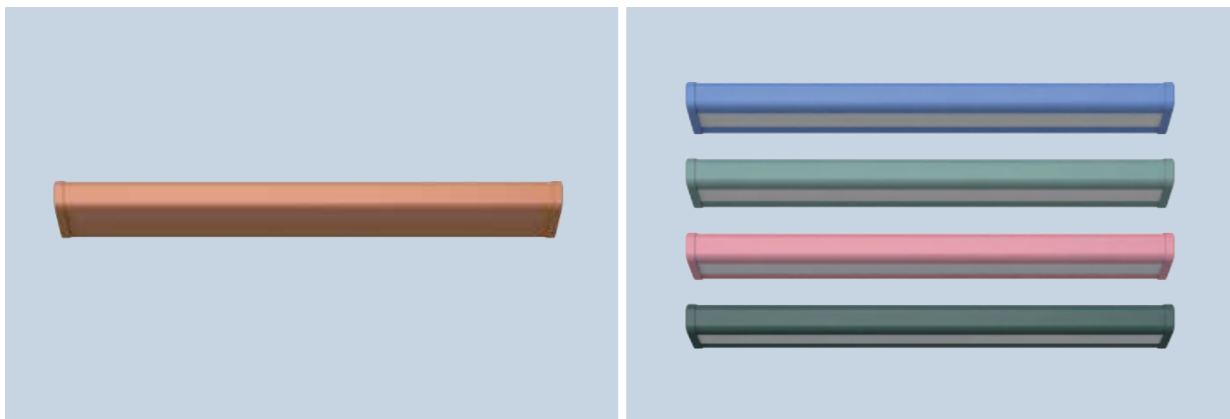

SCENE DISPLAY



ZXY-73

Cold top technology, showing luxury

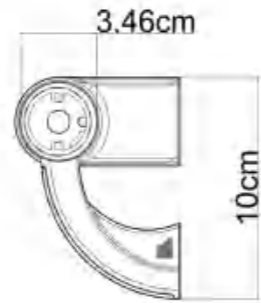

ZXY-73

Model	Material	Aluminum Thickness	Size	Color
ZXY-73	Cold top processpanel+aluminum +Zinc alloy elbow bracket	1.8mm	4000*34.6mm	varied

STYLE DISPLAY

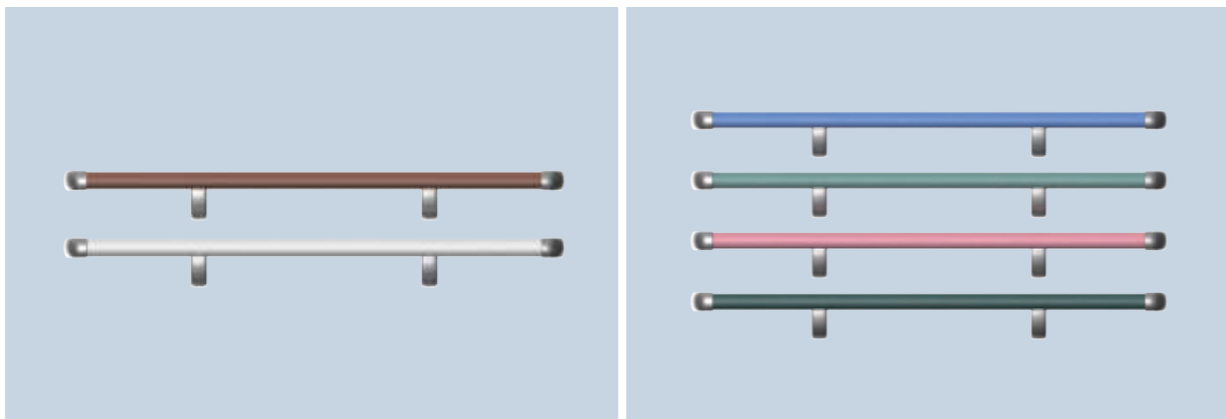

SCENE DISPLAY



ZXY-74

Lights with handrails are safer for use at night

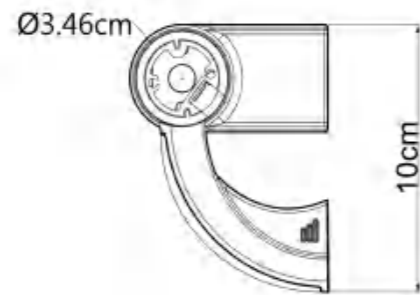

ZXY-74

Model	Material	Aluminum Thickness	Size	Color
ZXY-74	Various transparent splicing process panels+Zinc alloy elbow bracket	1.8mm	4000*34.6mm	varied

STYLE DISPLAY

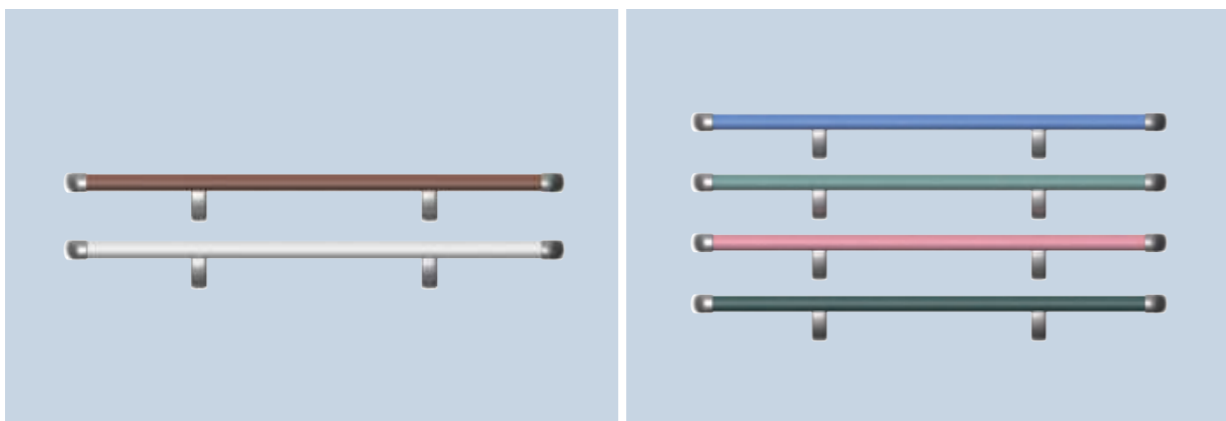

SCENE DISPLAY



ZXY-75

Solid wood handrails,
fine workmanship
Green environmental
protection, real
materials

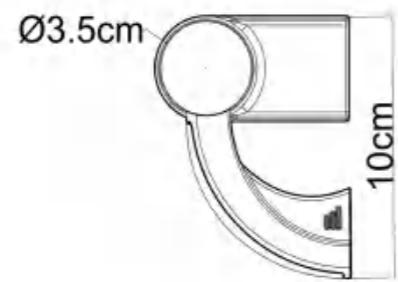
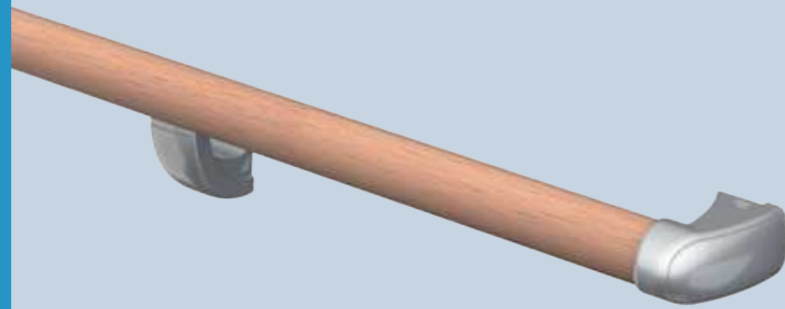

ZXY-75

Model	Material	Size	Color
ZXY-75	Solid wood+champagne gold/silver zinc alloy elbow brackets	4000*35mm	varied

STYLE DISPLAY

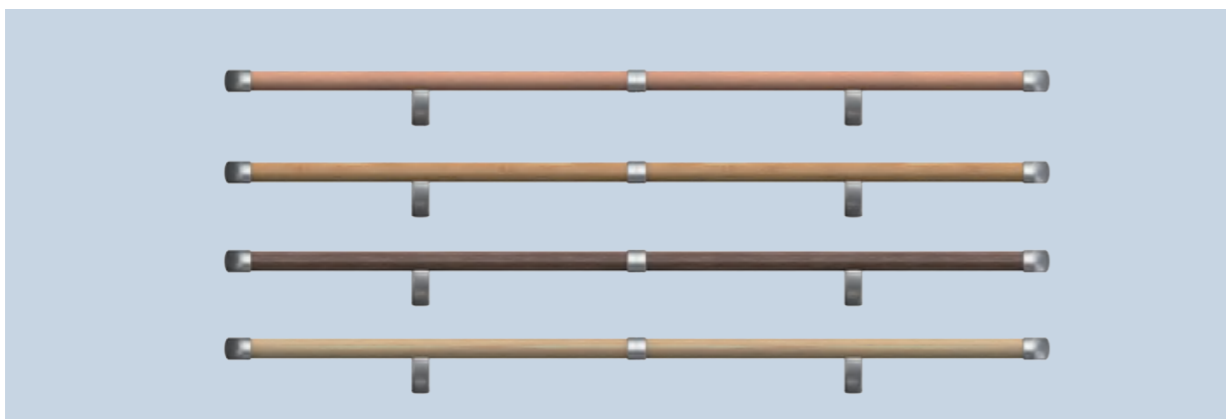

SCENE DISPLAY



ZXY-152H

Line and surface modeling, fashionable appearance

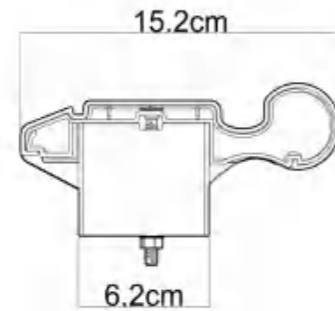

ZXY-152H

Model	Material	Aluminum Thickness	Size	Color
ZXY-152H	Cold top process panel +ABS elbow bracket	1.8mm	4000*152mm	varied

STYLE DISPLAY

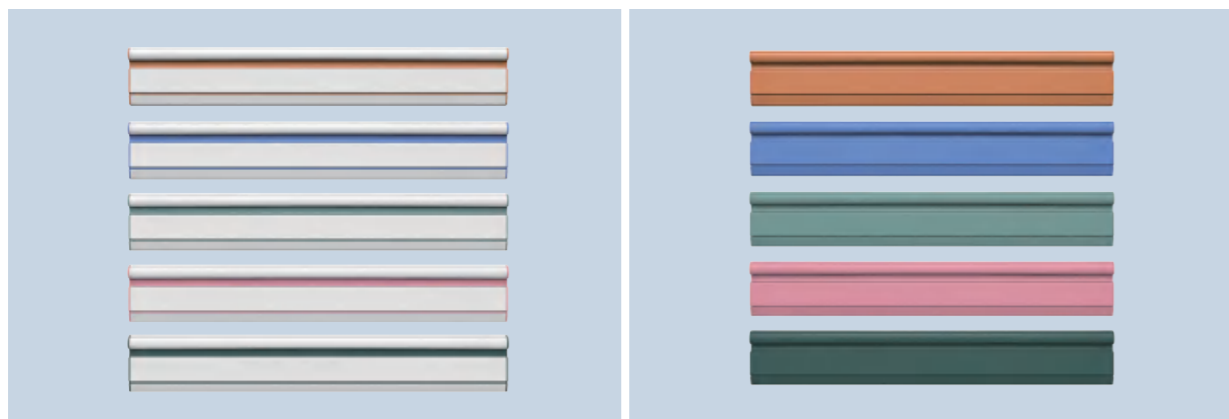

SCENE DISPLAY



ANTI-COLLISION SERIES

FEATURES:

- A: internal metal structure strength is good, appearance of vinyl resin material, warm and not cold.
- B: surface split molding.
- C: upper edge tube style is ergonomic and comfortable to grip.
- D: lower edge arc shape can absorb impact strength and protect walls.



ZXY-152

Corrosion resistant
and easy to clean
Avoid wall damage

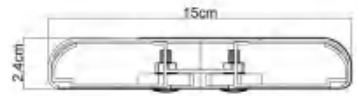

ZXY-152

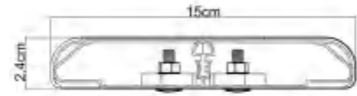

ZXY-152R

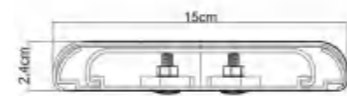

ZXY-152-1

Model	Material	Aluminum Thickness	Size	Color
ZXY-152	PVC panel+aluminum+end cap	1.2/1.4/1.6/1.8/1.9mm	4000*150mm	varied

STYLE DISPLAY

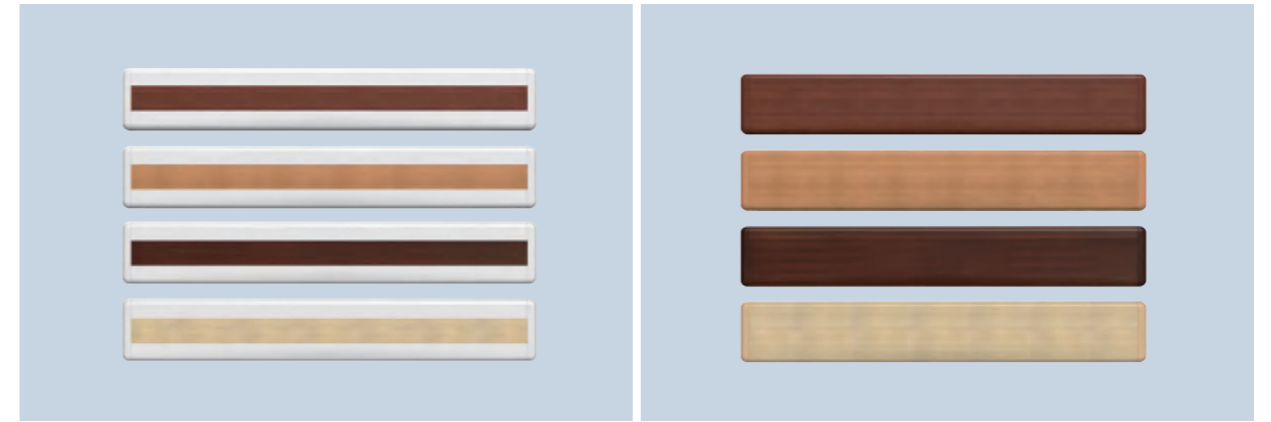

SCENE DISPLAY



ZXY-102

Corrosion resistant
and easy to clean
Avoid wall damage

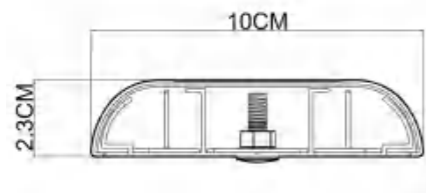

ZXY-102A

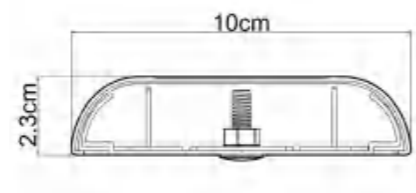

ZXY-102

Model	Material	Aluminum Thickness	Size	Color
ZXY-102	PVC panel+aluminum+end cap	1.2/1.4/1.5mm	4000*100mm	varied

STYLE DISPLAY

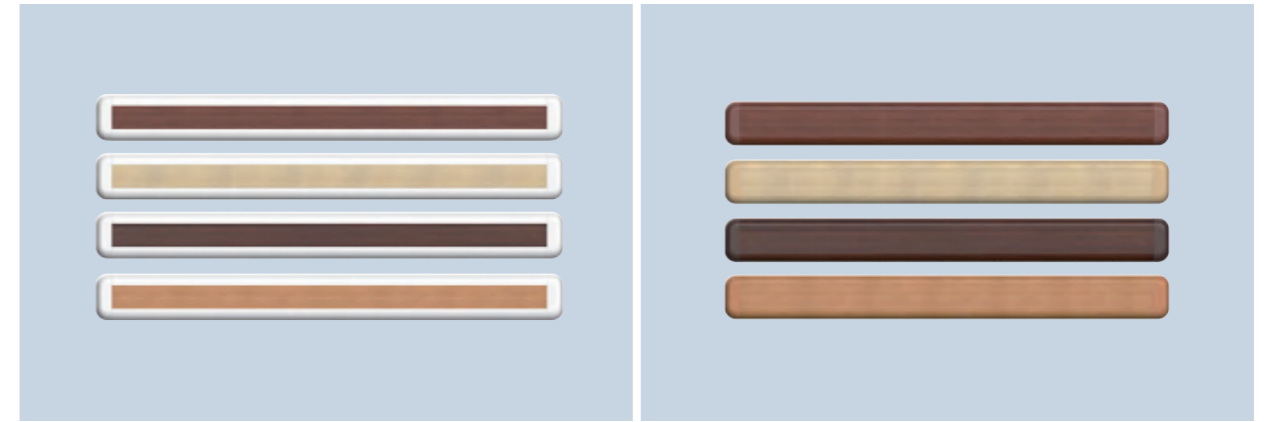

SCENE DISPLAY



ZXY-120

Corrosion resistant
and easy to clean
Avoid wall damage

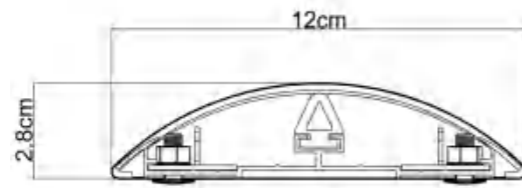

ZXY-120

Model	Material	Aluminum Thickness	Size	Color
ZXY-120	PVC panel+aluminum+end cap	1.4MM	4000*120MM	varied

STYLE DISPLAY

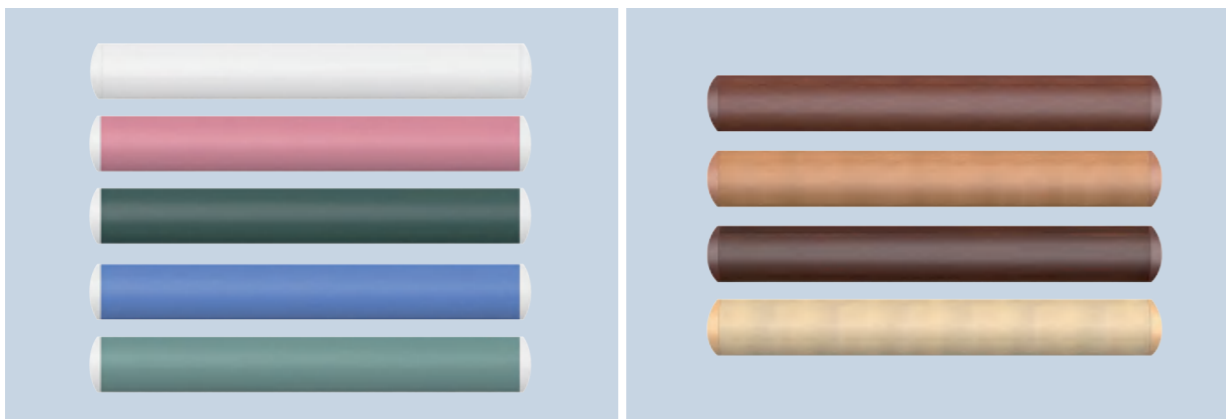

SCENE DISPLAY



ZXY-125

Corrosion resistant
and easy to clean
Avoid wall damage

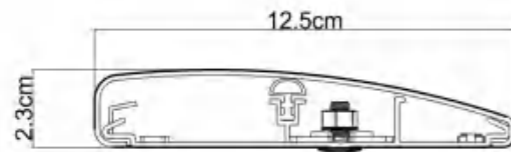

ZXY-125

Model	Material	Aluminum Thickness	Size	Color
ZXY-125	PVC panel+aluminum+end cap	1.4mm	4000*125mm	varied

STYLE DISPLAY

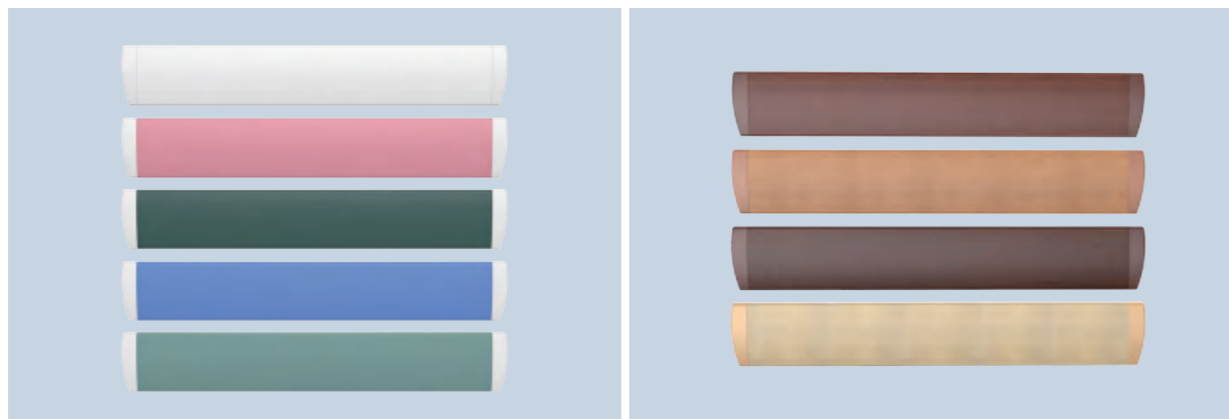

SCENE DISPLAY



ZXY-200W

Corrosion resistant
and easy to clean
Avoid wall damage

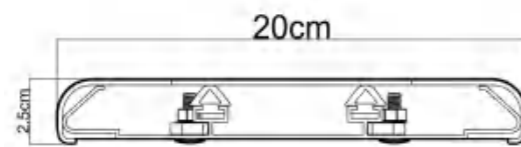

ZXY-200W

Model	Material	Aluminum Thickness	Size	Color
ZXY-200W	PVC panel+aluminum+end cap	1.5mm	4000*200mm	varied

STYLE DISPLAY

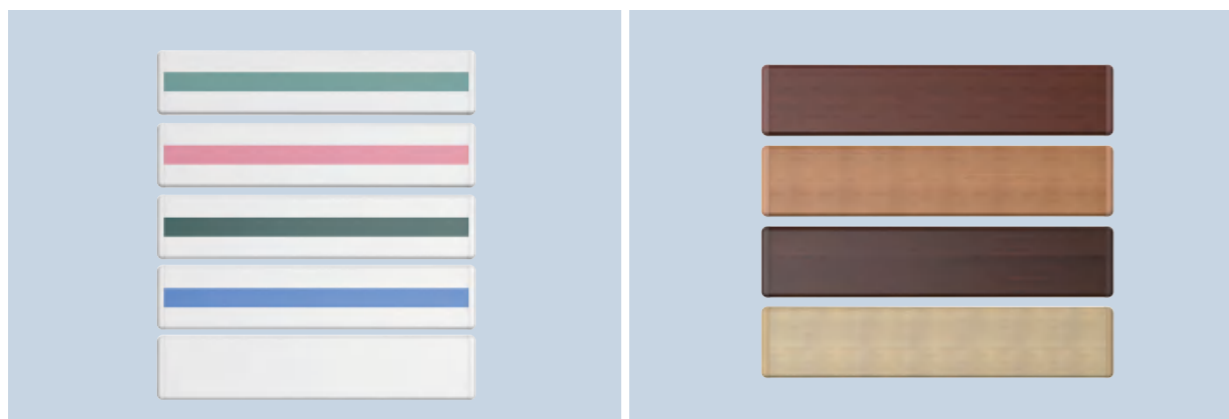

SCENE DISPLAY



ZXY-200C

Corrosion resistant
and easy to clean
Avoid wall damage

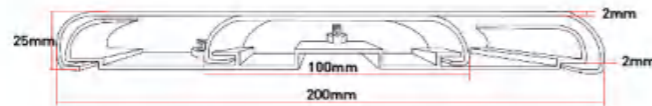
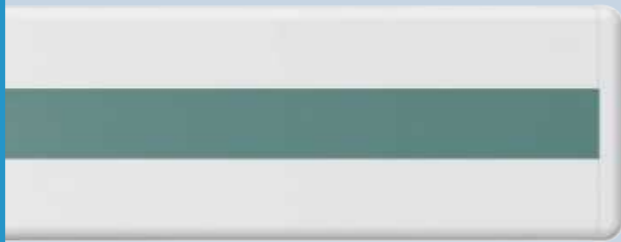

ZXY-200C

Model	Material	Aluminum Thickness	Size	Color
ZXY-200C	PVC panel+aluminum+end cap	1.5mm	4000*200mm	varied

STYLE DISPLAY

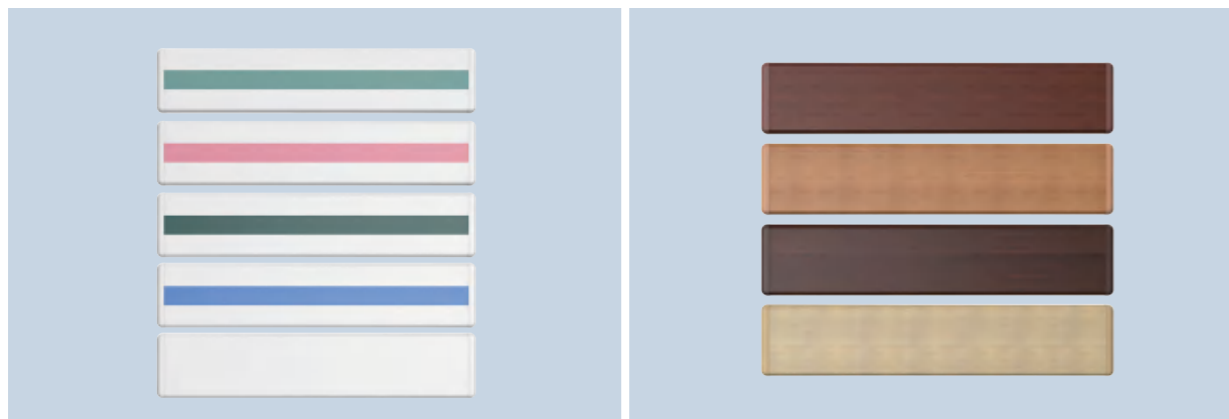

SCENE DISPLAY



ZXY-200D

Corrosion resistant
and easy to clean
Avoid wall damage

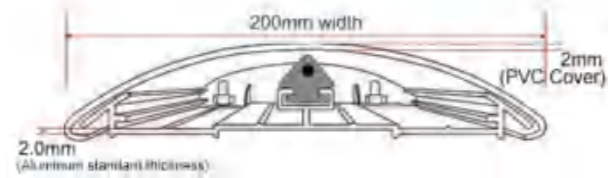

ZXY-200D

Model	Material	Aluminum Thickness	size	Color
ZXY-200D	PVC panel+aluminum+end cap	1.6mm	4000*200mm	varied

STYLE DISPLAY

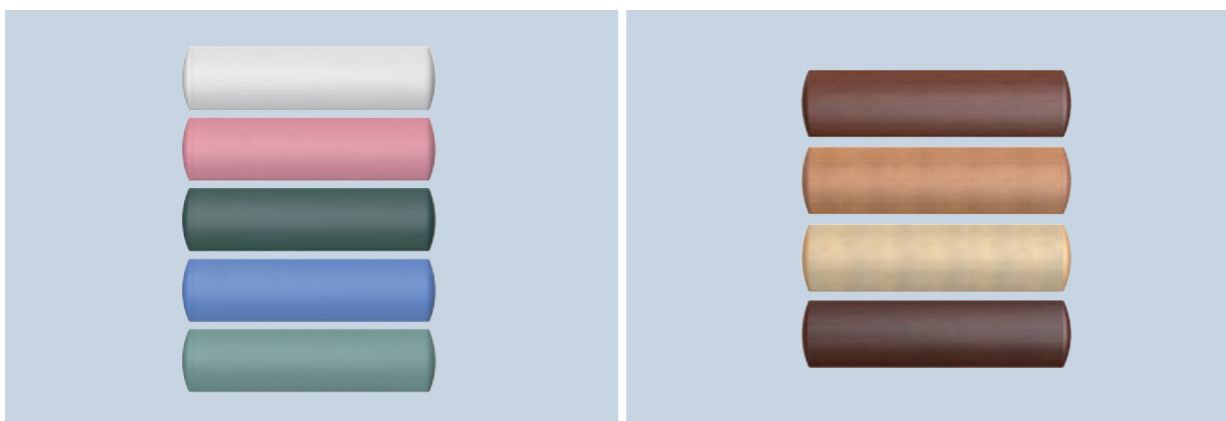

SCENE DISPLAY



ZXY-75H

Corrosion resistant
and easy to clean
Avoid wall damage

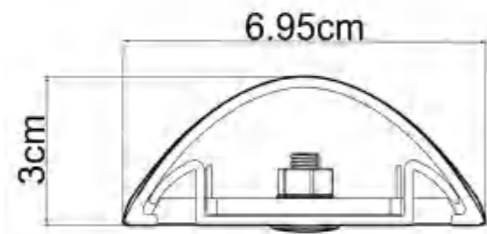

ZXY-75H

Model	Material	Aluminum Thickness	size	Color
ZXY-75H	PVC panel+aluminum+end cap	1.7mm	4000*69.5mm	varied

STYLE DISPLAY

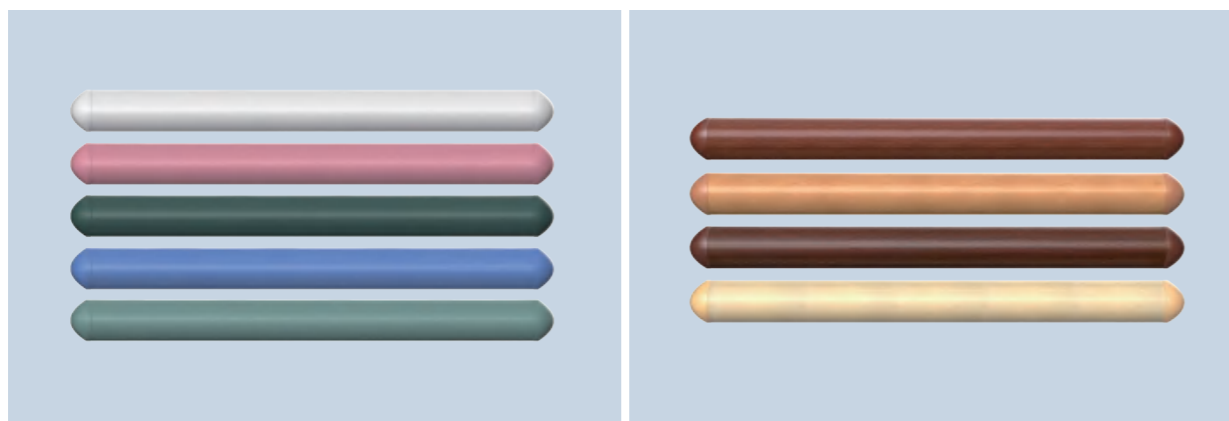

SCENE DISPLAY



ZXY-05H

Corrosion resistant
and easy to clean
Avoid wall damage

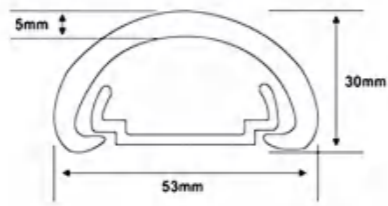
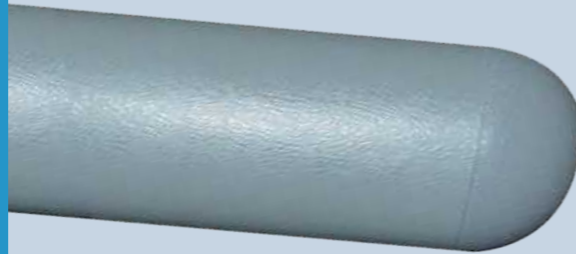

ZXY-05H

Model	Material	Aluminum Thickness	size	Color
ZXY-05H	PVC panel+aluminum+end cap	1.7mm	4000*69.5mm	varied

STYLE DISPLAY

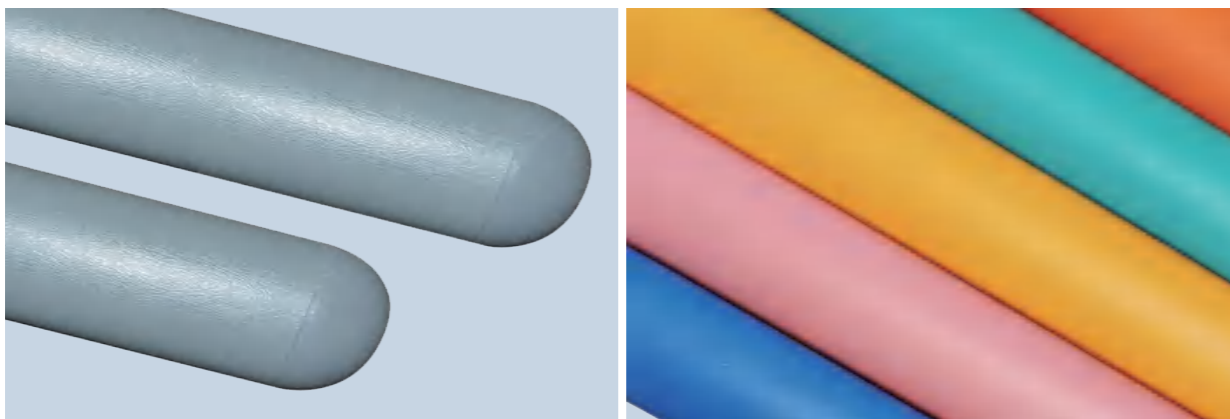

SCENE DISPLAY





WALL PROTECTION PRODUCT LINE

WALL PROTECTION
NEWMODELAND FASHION STYLE

INTEGRAL WALL PANEL SERIES

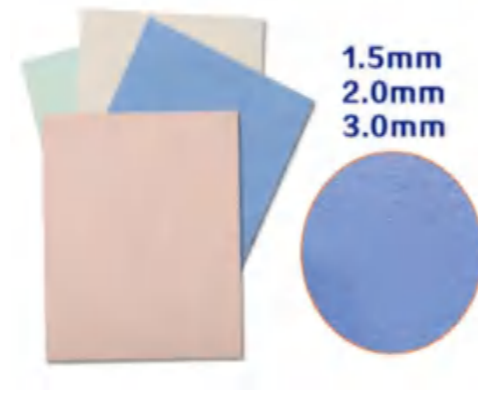

FEATURES:

- A: internal metal structure strength is good, appearance of vinyl resin material, warm and not cold.
- B: surface split molding.
- C: upper edge tube style is ergonomic and comfortable to grip.
- D: lower edge arc shape can absorb impact strength and protect walls.



Features and Benefits:

- Easy to clean
- Anti-corrosive & Antibacterial
- Impact Resistant
- Abrasion Resistant
- Rich Color Options
- Green Products
- Highly Malleable
- UV-Stabilized
- Fireproof



Wall Covering is perfect for trouble spots that endure commercial damage , offering high impact resistance. It is durable & easy to clean.

Wall Covering is used at wainscot height or full wall height, can be used as door protection, wall base to protect your walls, doors and cabinetry in any facility and any application.

Wall Covering protects in a broad range of uses, from corridor wainscot and patient room walls, to back-of-house areas and slop sink backsplashes. Or it can simply be used as a finishing touch to complete a unified presentation in wall protection system designs.

All while providing added texture and color to whatever design scheme you choose. Available in 20 standard colors, and any custom color you can dream of, Our wall covering has the versatility to serve your needs.

Accessories, including top cap, Joint Strip, Curve Former, and Outside Corner. Or color-matched caulk provide a continual seamless look.





WALL BASE PRODUCT LINE

WALL PROTECTION
NEWMODELAND FASHION STYLE

ZXY-1220

Corrosion resistant
and easy to clean
Avoid wall damage



STYLE DISPLAY

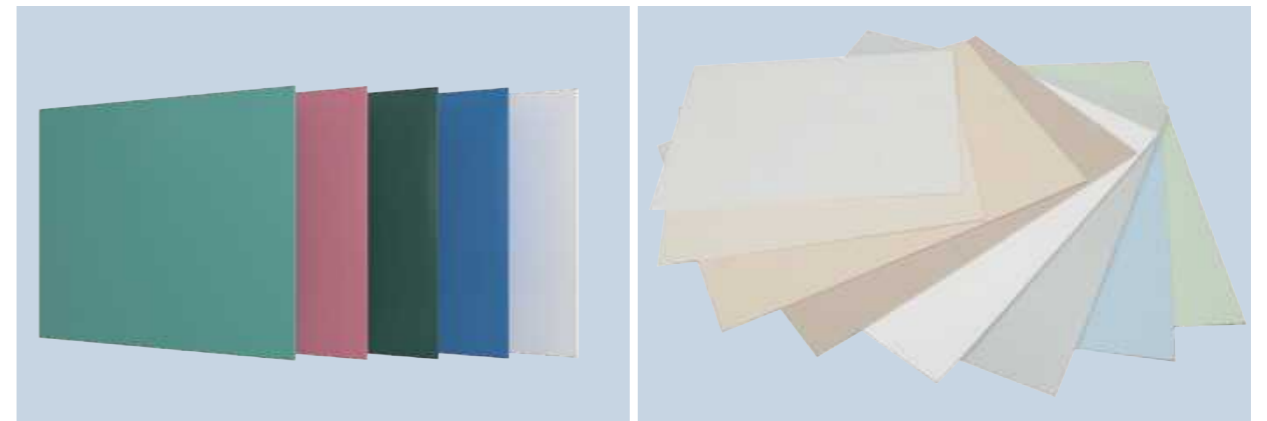

SCENE DISPLAY



Application	It's widely used in office buildings, hospitals, schools, kindergartens, nursing homes....., protecting protecting the wall from impact.
Thickness	1.0mm / 1.5 mm / 2.0mm / 2.5mm / 3.0mm
Standard Size	1.22*2.44m or as request
Color	Customizable
Additional Features	flame-retardant, water-proof, anti-bacterial, impact-resistant



PANTONE COLOR CARD

7609 C 038	431 C 038	CoolGray 4 C 026	CoolGray 1 C 018	2707 C 050
7731 C 112	358 C 040	3285 C 009	3523 C 020	2310 C 105
7507 C 041	121 C 006	563 C 088	343 C 024	562 C 008
2317 C 011	7690 C 033	2727 C 002	429 C 027	2011 C 008
1595 C 022	707 C 010	Warm Gray 1 C 021	7625 C 108	7582 C 016
304 C 004	1205 C 146	123 C 007	7500 C 005	563 C 012
7532 C 019	2185 C 056	2148 C 003	526 C 080	7474 C 007

※ Anti collision product line Anti collision handrails, wall panels, wall corners and other products above can be customized



DOOR PROTECTION PRODUCT LINE

WALL PROTECTION
NEWMODELAND FASHION STYLE



Features and Benefits:

- Easy to clean
- Anti-corrosive & Antibacterial
- Impact Resistant
- Abrasion Resistant
- Rich Color Options
- Green Products
- Highly Malleable
- UV-Stabilized
- Fireproof





CHAIR RAIL PRODUCT LINE

WALL PROTECTION
NEW MODEL AND FASHION STYLE

ZXY-150P

Corrosion resistant
and easy to clean
Avoid wall damage

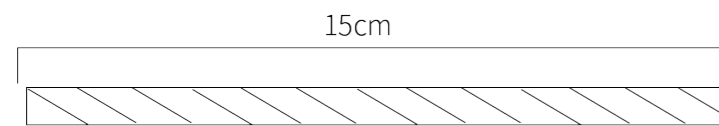

ZXY-150P

Model	Material	Aluminum Thickness	size	Color
ZXY-150P	PVC panel/ABS	1.8/2.0mm	15 cm wide	varied

STYLE DISPLAY

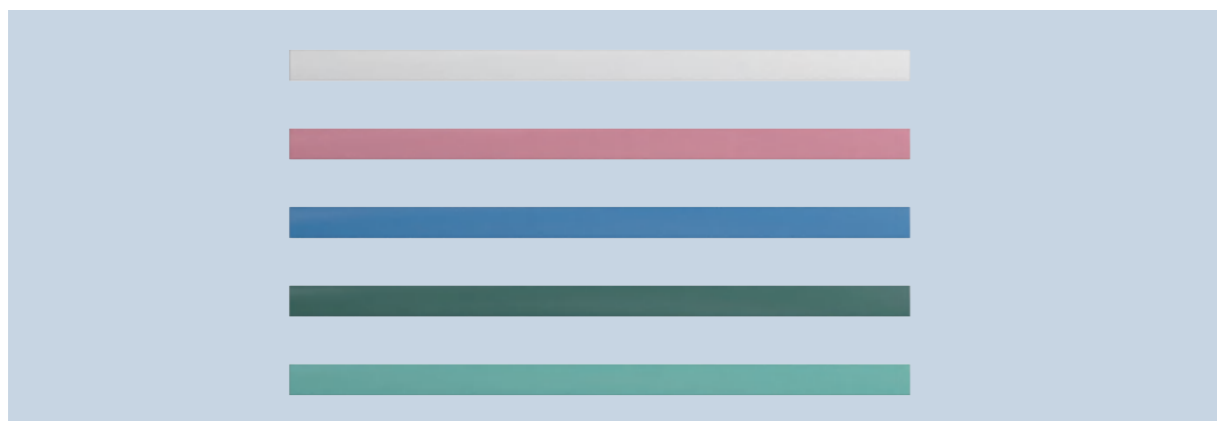

SCENE DISPLAY



ZXY-200P

Corrosion resistant
and easy to clean
Avoid wall damage

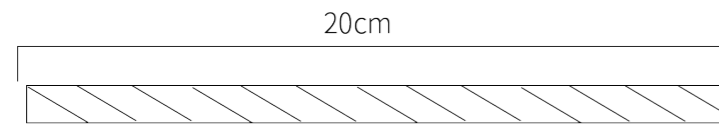

ZXY-200P

Model	Material	Aluminum Thickness	size	Color
ZXY-200P	PVC panel/ABS	1.8/2.0/2.5mm	20 cm wide	varied

STYLE DISPLAY

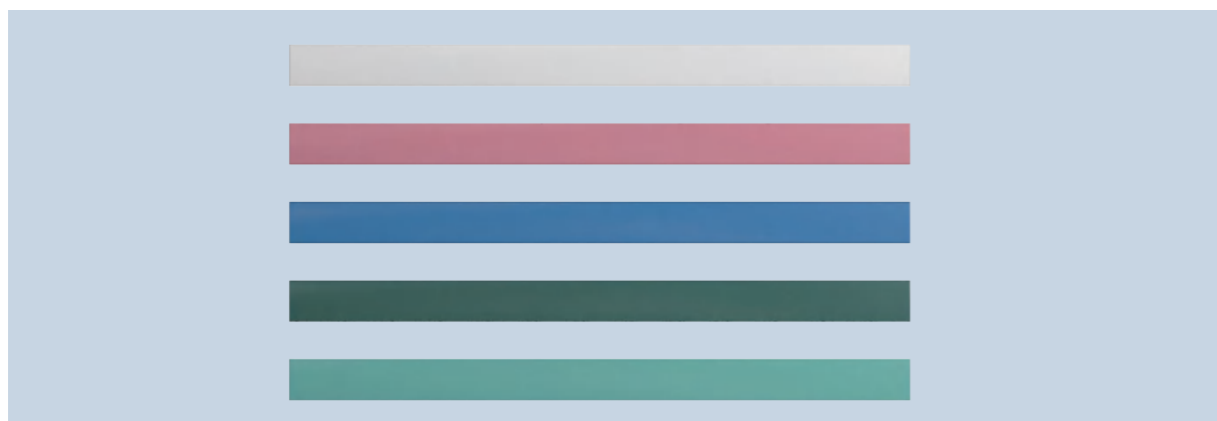

SCENE DISPLAY



PVC ACCESSORIES

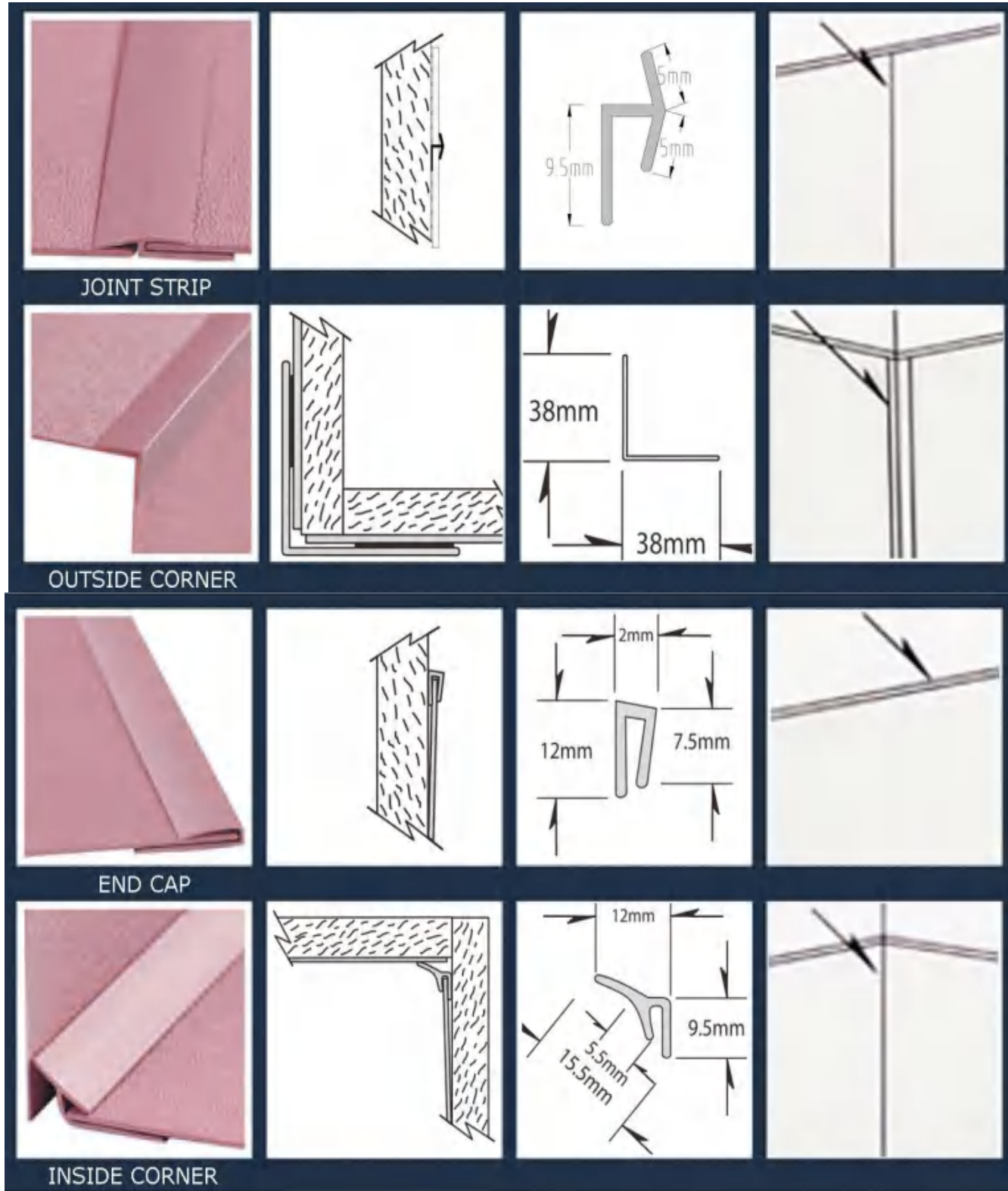

ALUMINIUM ACCESSORIES

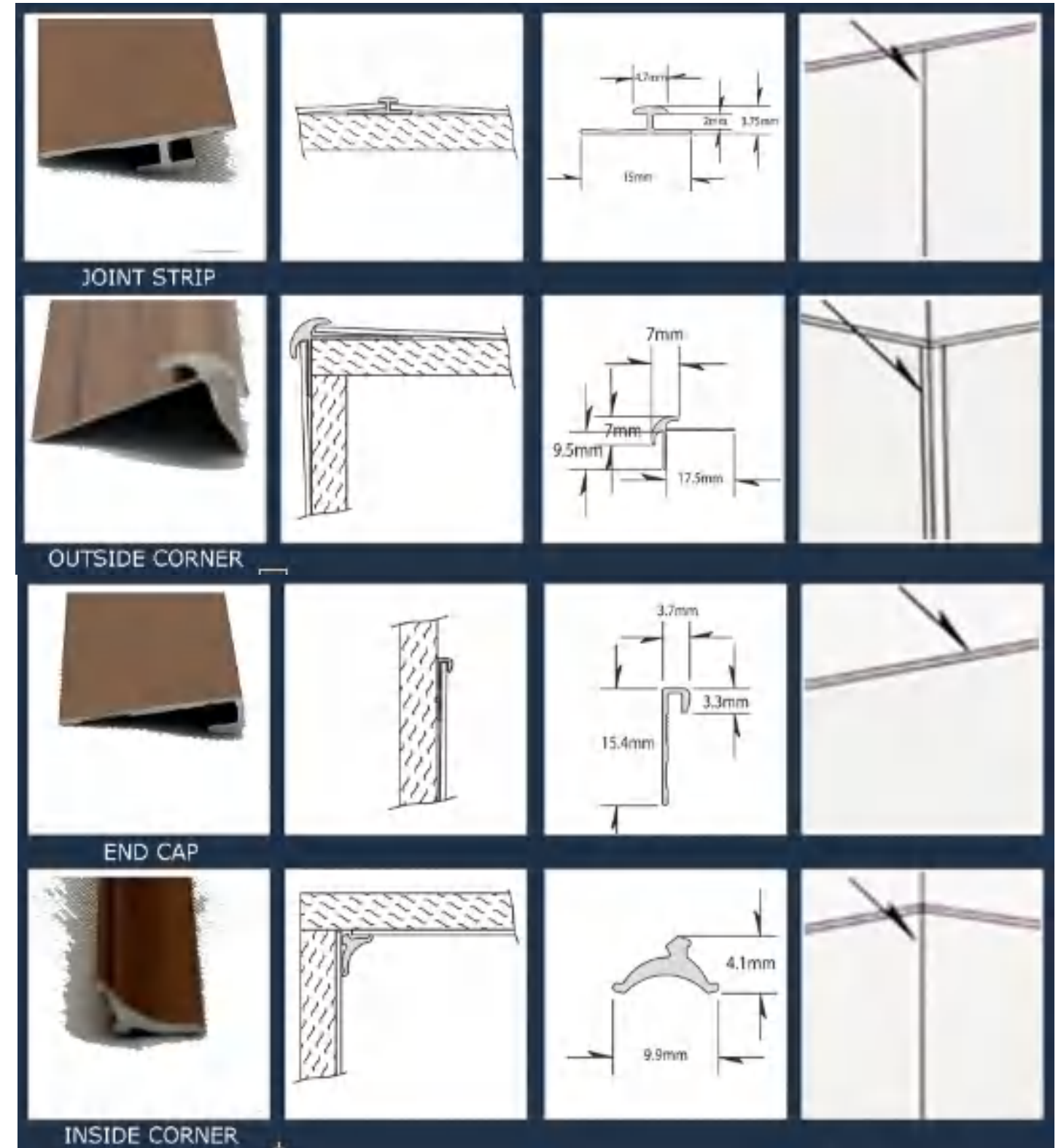

CORNER GUARD SERIES

FEATURES:

- A: internal metal structure strength is good, appearance of vinyl resin material, warm and not cold.
- B: surface split molding.
- C: upper edge tube style is ergonomic and comfortable to grip.
- D: lower edge arc shape can absorb impact strength and protect walls.



● HARD CORNER GUARD

Applicable to hospitals, nursing homes, home care centers, kindergartens, schools, Early education institutions, children's playgrounds, hotels, high-end commercial buildings, Factory workshop, etc.



ZXY-30

Side width:30x30mm
Side length:3m/pc
Corner angle: 90°

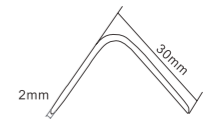

ZXY-50

Side width:50x50mm
Side length:3m/pc
Corner angle: 90°

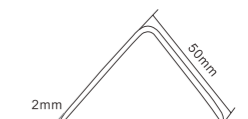



ZXY-50A
 Side width:50x50mm
 Side length:3m/pc
 Corner angle: 90°

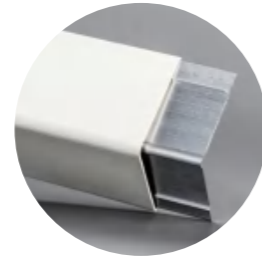
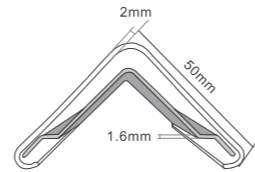

ZXY-76A
 Side width:76x76mm
 Side length:3m/pc
 Corner angle: 90°

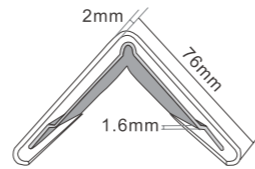

ZXY-50B
 Side width:50x50mm
 Side length:3m/pc
 Corner angle: 135°

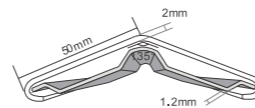

● **SOFT CORNER GUARD**

Applicable to hospitals, nursing homes, home care centers, kindergartens, schools, Early education institutions, children's playgrounds, hotels, high-end commercial buildings, Factory workshop, etc.

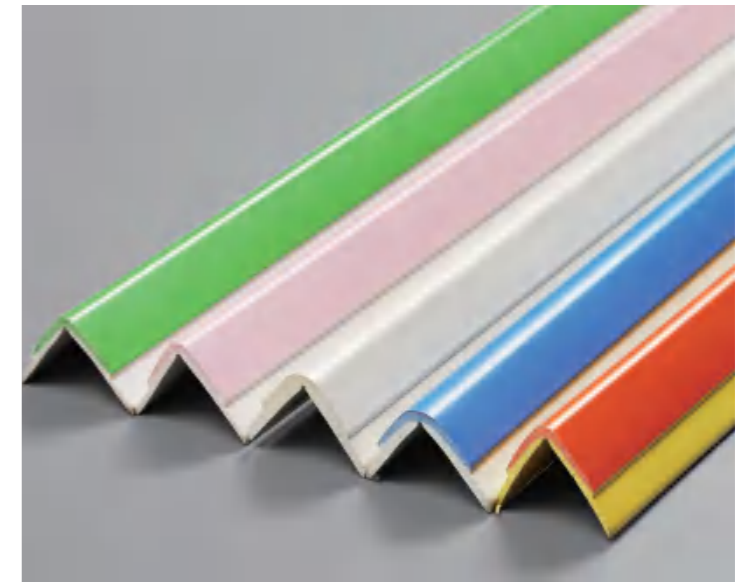

ZXY-35R
 Side width:35x35mm
 Side length:3m/pc
 Corner angle: 90°

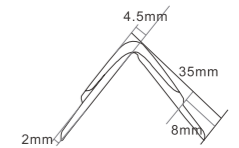

ZXY-50R
 Side width:50x50mm
 Side length:3m/pc
 Corner angle: 90°

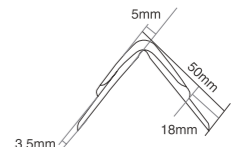



BATHROOM PRODUCT LINE

GLOBAL BARRIER FREE INTEGRATED
SOLUTIONS EXPERT

HEALTHSEASONS PRECISION



CONTENTS

01

BATHROOM
HANDRAIL

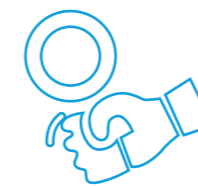

Delicate material



Top research and development

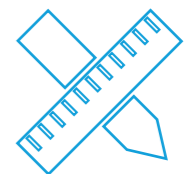

Well-designed

02

SHOWER
CHAIR

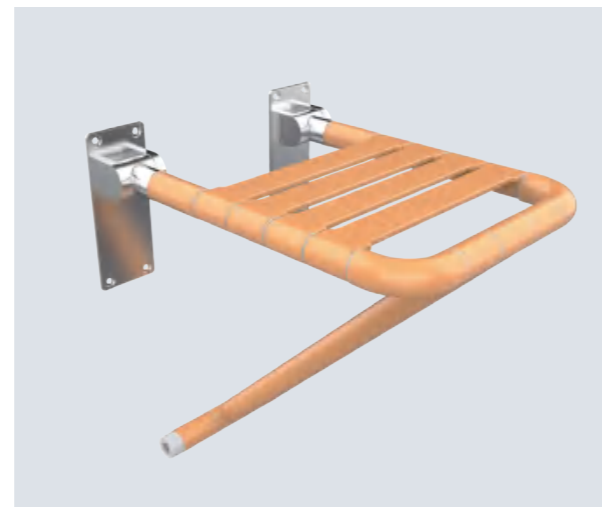

Lean Production



Environmental friendly



Sinsere Service

FLAT HANDRAIL

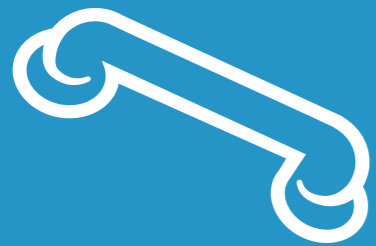

High quality material selection
 Reassurance protection
 Take good care of your family

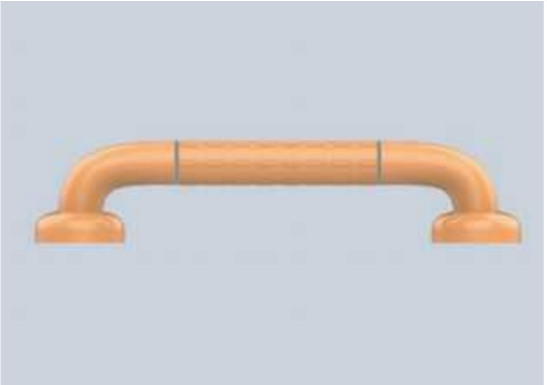
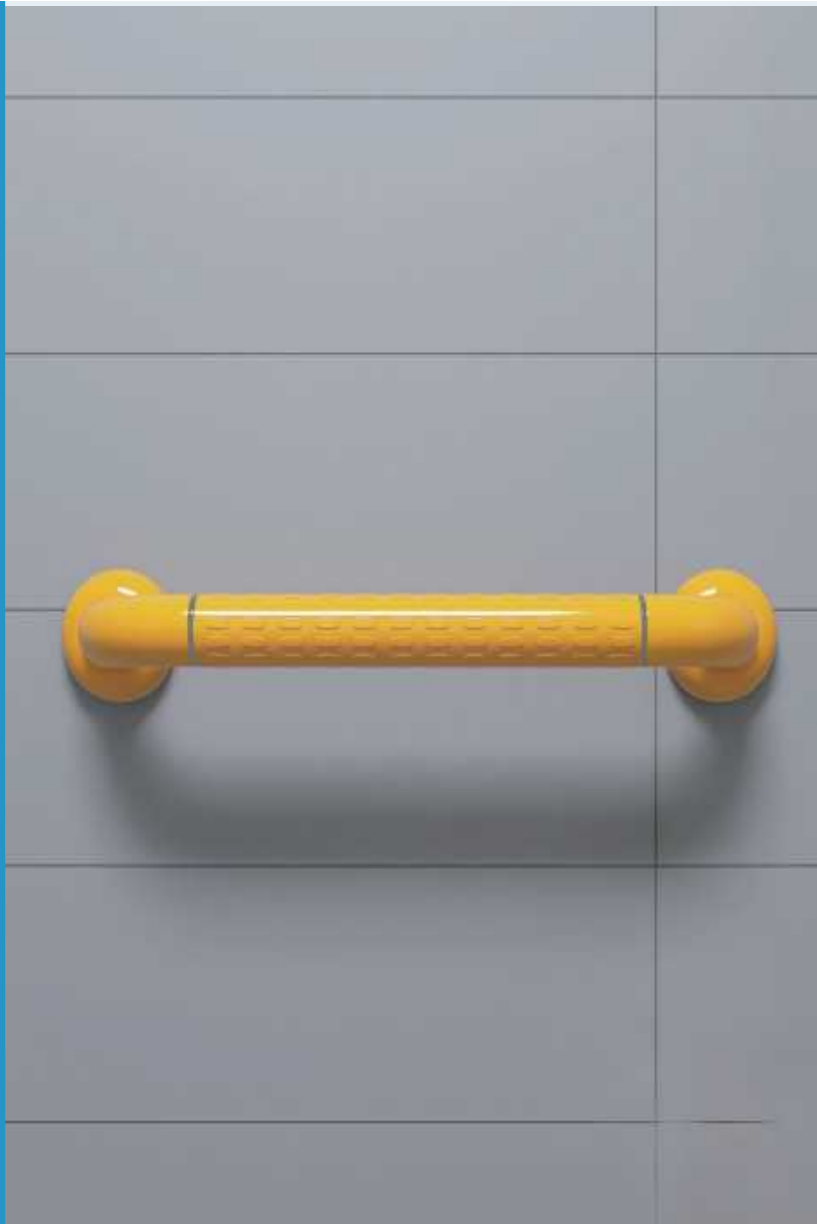

ZXY32-23
 Size: length can be customized
 Color: yellow/white Others can be customized
 Outer tube ϕ : 35mm
 Inner tube ϕ : 25mm



ZXY32-23AS
 Size: length can be customized
 Color: yellow/white Others can be customized
 Outer tube ϕ : 35mm
 Inner tube ϕ : 25mm



ZXY32-23S
 Size: length can be customized
 Color: yellow/white Others can be customized
 Pipe diameter: 30mm
 Wall thickness: 1mm



ZXY-32-23RS
 Size: length can be customized
 Color: yellow/white Others can be customized
 Pipe diameter: 30mm
 Wall thickness: stainless steel 1mm/
 rubber 2mm

CLASSIFICATION	STANDARD EDITION	PREMIUM EDITION
TO CONFIGURE	ABS+201 stainless steel	ABS/nylon+304 stainless steel
CLASSIFICATION	1.0±0.2mm	1.2±0.2mm



ZXY-32A
 Size: length can be customized
 Color: yellow/white Others can be customized
 Outer tube ϕ : 35mm
 Inner tube ϕ : 25mm



ZXY-32 Corridor Handrail
 Size: length can be customized
 Color: yellow/white Others can be customized
 Outer tube ϕ : 35mm
 Inner tube ϕ : 25mm



TOILET HANDRAIL

High quality material selection, safety and environmental protection

Fire resistance, wear resistance and aging resistance

For you and your family

More security

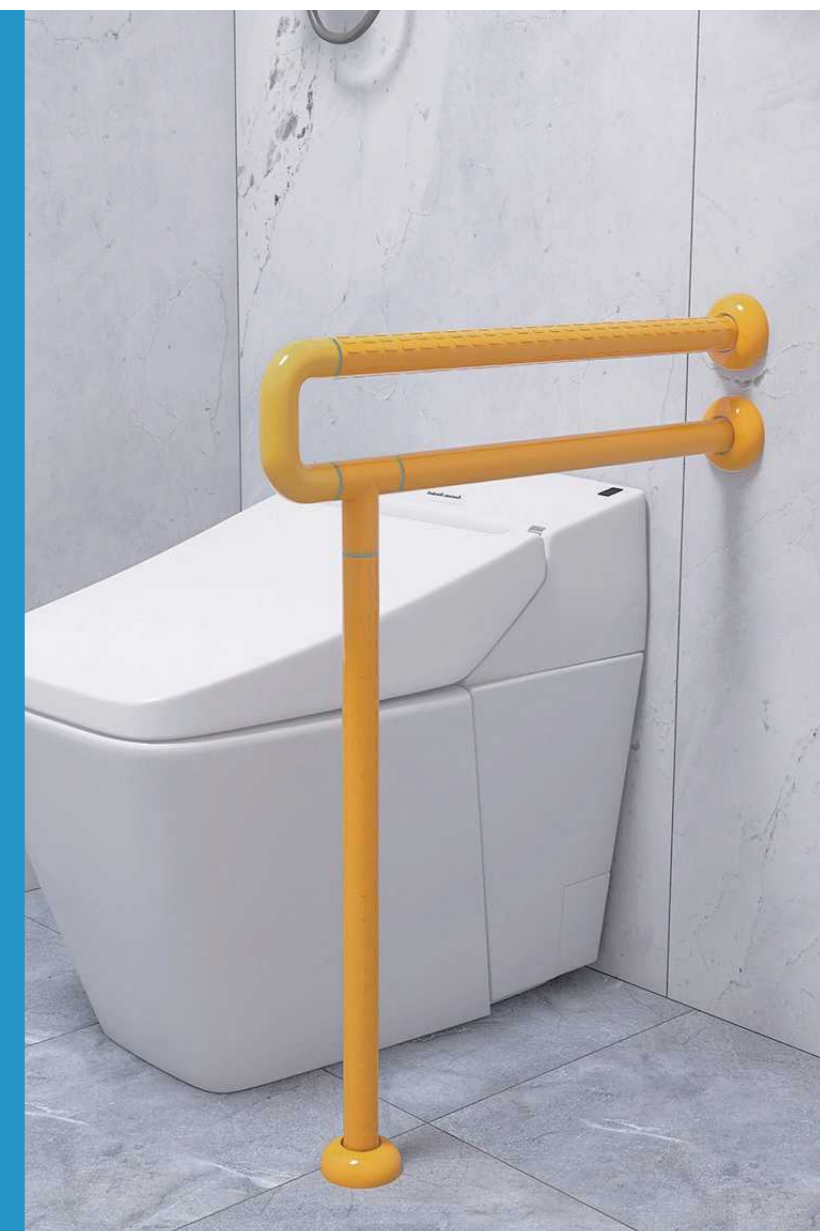

CLASSIFICATION	STANDARD EDITION	PREMIUM EDITION
TO CONFIGURE	ABS+201 stainless steel	ABS/nylon+304 stainless steel
CLASSIFICATION	1.0±0.2mm	1.2±0.2mm



ZXY32-37-2

Size: length can be customized
 Color: yellow/white Others can be customized
 Outer tube ϕ : 35mm
 Inner tube ϕ : 25mm



ZXY32-35-2

Size: length can be customized
 Color: yellow/white Others can be customized
 Outer tube ϕ : 35mm
 Inner tube ϕ : 25mm

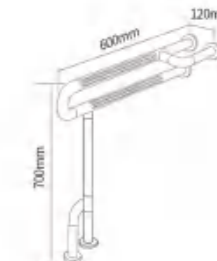

ZXY32-37

Size: length can be customized
 Color: yellow/white Others can be customized
 Outer tube ϕ : 35mm
 Inner tube ϕ : 25mm

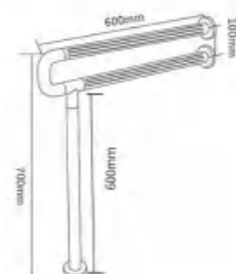

ZXY32-29-A

Size: length can be customized
 Color: yellow/white Others can be customized
 Outer tube ϕ : 35mm
 Inner tube ϕ : 25mm

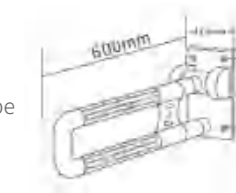

ZXY32-33

Size: length can be customized
 Color: yellow/white Others can be customized
 Outer tube ϕ : 35mm
 Inner tube ϕ : 25mm

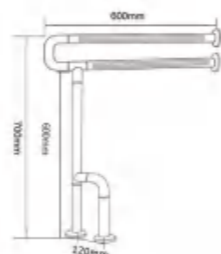

ZXY32-29-2

Size: length can be customized
 Color: yellow/white Others can be customized
 Outer tube ϕ : 35mm
 Inner tube ϕ : 25mm

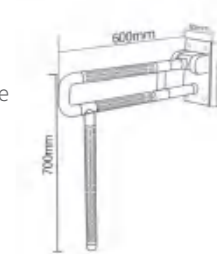

ZXY32-35

Size: length can be customized
 Color: yellow/white Others can be customized
 Outer tube ϕ : 35mm
 Inner tube ϕ : 25mm

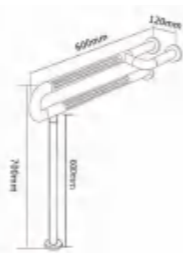

ZXY32-29

Size: length can be customized
 Color: yellow/white Others can be customized
 Outer tube ϕ : 35mm
 Inner tube ϕ : 25mm





ZXY32-22

Size: length can be customized
 Color: yellow/white Others can be customized
 Outer tube ϕ : 35mm
 Inner tube ϕ : 25mm

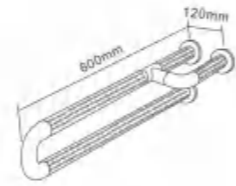

ZXY32-21-1

Size: length can be customized
 Color: yellow/white Others can be customized
 Outer tube ϕ : 35mm
 Inner tube ϕ : 25mm

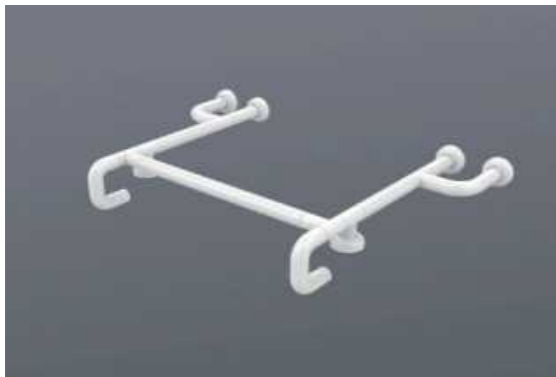
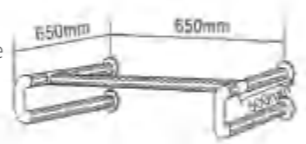

ZXY32-22-1

Size: length can be customized
 Color: yellow/white Others can be customized
 Outer tube ϕ : 35mm
 Inner tube ϕ : 25mm



ZXY32-21-2

Size: length can be customized
 Color: yellow/white Others can be customized
 Outer tube ϕ : 35mm
 Inner tube ϕ : 25mm



ZXY32-31

Size: length can be customized
 Color: yellow/white Others can be customized
 Outer tube ϕ : 35mm
 Inner tube ϕ : 25mm

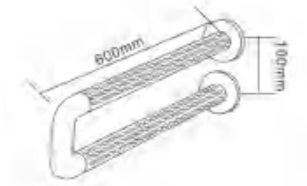

ZXY32-31A

Size: length can be customized
 Color: yellow/white Others can be customized
 Outer tube ϕ : 35mm
 Inner tube ϕ : 25mm

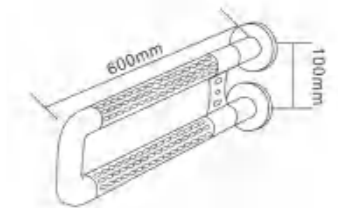

TOILET
HANDRAIL

Bilateral assistance
Safe and firm
Multi scenario application



ZXY32-21

Size: length can be customized
Color: yellow/white Others can be customized

Outer tube ϕ : 35mm
Inner tube ϕ : 25mm

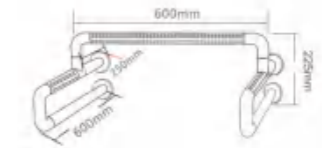

CLASSIFICATION	STANDARD EDITION	PREMIUM EDITION
TO CONFIGURE	ABS+201 stainless steel	ABS/nylon+304 stainless steel
CLASSIFICATION	1.0 \pm 0.2mm	1.2 \pm 0.2mm



ZXY32-20

Size: length can be customized
Color: yellow/white Others can be customized

Outer tube ϕ : 35mm
Inner tube ϕ : 25mm

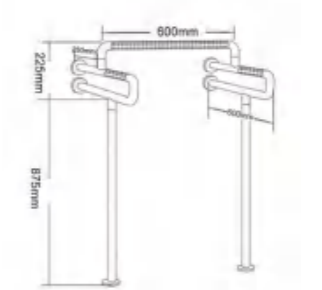

MULTI
FUNCTION
ARMREST

Easy installation

Safe and firm

Multi scenario
application



ZXY32-27

Size: length can be customized
Color: yellow/white Others can be customized

Outer tube ϕ : 35mm
Inner tube ϕ : 25mm

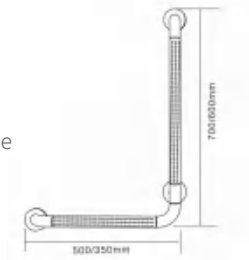

ZXY32-27AS

Size: length can be customized
Color: yellow/white Others can be customized

Outer tube ϕ : 35mm
Inner tube ϕ : 25mm

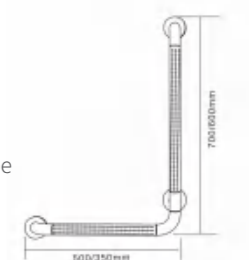

ZXY32-27S

Size: length can be customized
Color: stainless steel
Pipe diameter: 30mm
Wall thickness: 1mm

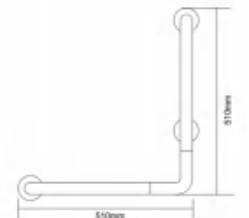

ZXY32-27WZ

Material: solid wood+zinc alloy
Size: length can be customized
Color: beech/white wax/bamboo/
black walnut

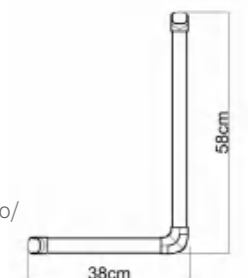

CLASSIFICATION	STANDARD EDITION	PREMIUM EDITION
TO CONFIGURE	ABS+201 stainless steel	ABS/nylon+304 stainless steel
CLASSIFICATION	1.0 \pm 0.2mm	1.2 \pm 0.2mm



ZXY32-25

Size: length can be customized
Color: yellow/white Others can be customized

Outer tube ϕ : 35mm
Inner tube ϕ : 25mm

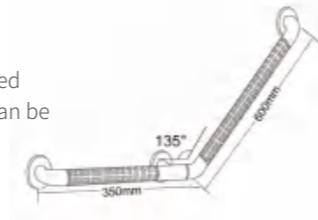

ZXY-32-40

Size: length can be customized
Color: yellow/white Others can be customized

Outer tube ϕ : 35mm
Inner tube ϕ : 25mm

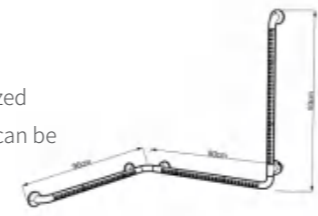

SHOWER CHAIR

Safe and comfortable, easy to fold

Does not take up space

Fine, smooth and delicate

Easy installation

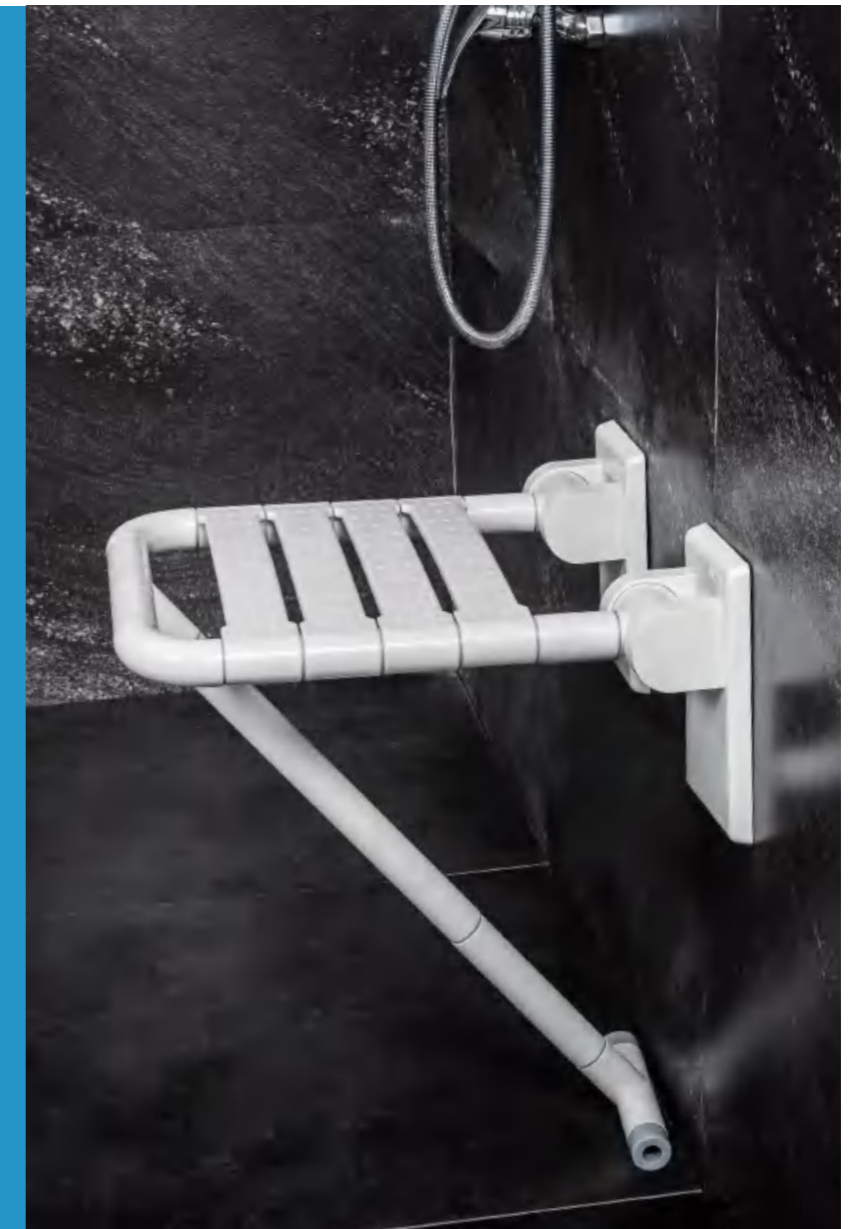

CLASSIFICATION	STANDARD EDITION	PREMIUM EDITION
TO CONFIGURE	ABS+201 stainless steel	ABS/nylon+304 stainless steel
CLASSIFICATION	1.0±0.2mm	1.2±0.2mm



ZXY-SS31

Size: 320x330mm
 Color: yellow/white
 Material: aluminum square tube+aluminum alloy base

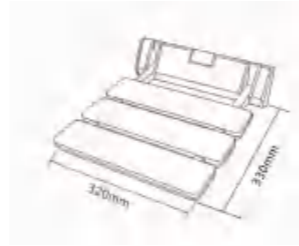

ZXY-SS39

Size: 450x340x320mm
 Color: yellow/white
 Outer tube ϕ : 35mm
 Inner tube ϕ : 25mm



ZXY-SS33

Size: 300x305mm
 Color: white
 Material: urea formaldehyde panel

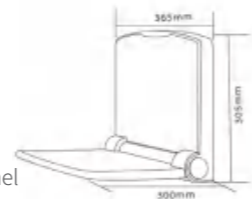

ZXY-SS38

Size: 650x360x500mm
 Color: yellow/white
 Outer tube ϕ : 35mm
 Inner tube ϕ : 25mm

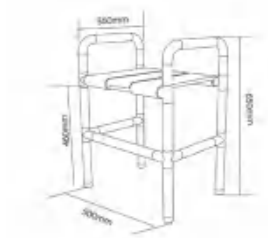

ZXY-SS36

Size: 320x450mm
 Color: yellow/white
 Outer tube ϕ : 35mm
 Inner tube ϕ : 25mm



ZXY-SS33-1

Size: 320x450mm
 Color: yellow/white
 Outer tube ϕ : 35mm
 Inner tube ϕ : 25mm

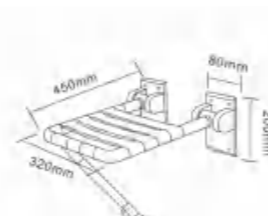

SHOWER CHAIR

Multifunctional shower chair
Safe / comfortable / non slip
Adjustable up and down



ZXY-1101A

Material: aluminum alloy
Color: white/blue
Pipe wall: 1.3mm
Configuration: five gear adjust



ZXY-1102A

Material: aluminum alloy
Color: white/blue
Pipe wall: 1.3mm
Configuration: five gear adjustable



ZXY-1104A

Material: aluminum alloy
Color: white/blue
Pipe wall: 1.3mm
Configuration: five gear adjustable

