

PL-PS-E60-24-2WPMW

Power Supply for use with ChromaFlex Warm-Dim and ParadigmLED single color series products. Power Supply for use with standard Triac dimming(forward or reverse phase) features a 24VDC 2-wire PWM output. Recommended load to be 80% of maximum rating.



Features:

- 60 Watts
- Output constant voltage
- Input voltage range 100-277VAC
- Built-in PFC function PF> 0.98
- Efficiency > 83% /Dimming range 0-100% Load:10~100%
- Protections: short circuit/over loading/Over temperature
- Cooling by free air convection/ Flicker -free
- Compatible with Forward phase, Reverse phase, Triac, MLV, ELV dimmers.
- Metal housing, suitable for dry, damp, wet location
- UL Listed Nema3R
- 5 year warranty

■ Mechanical Dimensions:

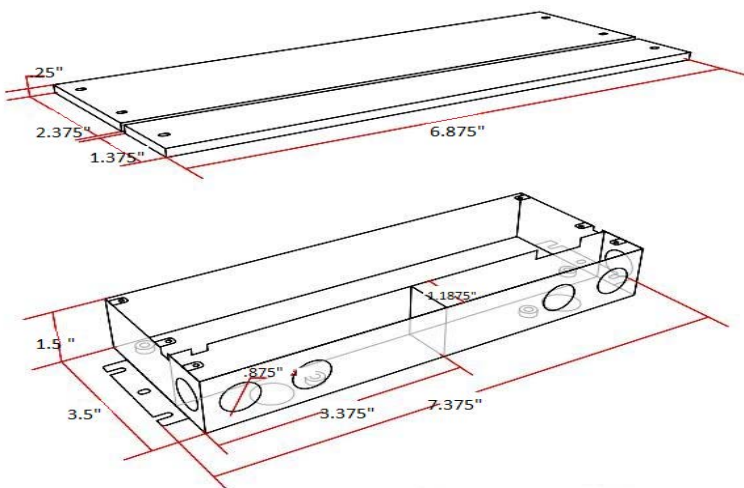

7.375"L x 3.5"W x 1.5"H

■ Dimming Operation

- The Pulse-Width Modulation (PWM) of output voltage can be adjusted through input terminal of the AC phase line(L) by connection a phase/triac dimmer.
- For use with Forward phase, leading edge, Magnetic low voltage, triac dimmers, or Reverse phase, trailing edge ,Electric low voltage Dimmers.

■ Wiring Specifications

- Input wire 18AWG Black and White to be connected to AC L and N ,Green wire connect to ground

- Output wire 18AWG Red to LED Positive side (+) , Black to LED Negative side (-).

■ WIRING DIAGRAM

