



## Cordex DC/DC Converter

# CXDF 24-48/2kW, 24V In – 48V Out Installation & Operation Manual

Part # 012-526-B2  
Effective: 07/2020



*Your Power Solutions Partner*



# Important Safety Instructions

**SAVE THESE INSTRUCTIONS:** This manual contains important safety instructions that must be followed during the installation, servicing, and maintenance of the product. Keep it in a safe place. Review the drawings and illustrations contained in this manual before proceeding. If there are any questions regarding the safe installation or operation of this product, contact Alpha and Outback Energy GmbH or the nearest AOE representative. Save this document for future reference.

## Safety Symbols

To reduce the risk of injury or death, and to ensure the continued safe operation of this product, the following symbols have been placed throughout this manual. Where these symbols appear, use extra care and attention.

The use of ATTENTION indicates specific regulatory/code requirements that may affect the placement of equipment and /or installation procedures.

### NOTE:

---

A NOTE provides additional information to help complete a specific task or procedure.



### CAUTION!

---

CAUTION indicates safety information intended to PREVENT DAMAGE to material or equipment. Cautions are designated with a shock hazard icon, the word CAUTION, and a rule beneath which the information appears.



### WARNING!

---

WARNING presents safety information to PREVENT INJURY OR DEATH to personnel. Warnings are indicated by a shock hazard icon, the word WARNING, and a rule beneath which the information appears.



### HOT!

---

The use of HOT presents safety information to PREVENT BURNS to the technician or user.

## General Safety



### WARNING!

---

This system is designed to be installed in a restricted access location that is inaccessible to the general public.

## Mechanical Safety

- Keep hands and tools clear of fans. Fans are thermostatically controlled and switch on automatically.
- Power supplies can reach extreme temperatures under load.
- Use caution around sheet metal components and sharp edges.

## Electrical Safety



### WARNING!

---

**Hazardous voltages are present at the input of power systems. The DC output from rectifiers and batteries, though not dangerous in voltage, has a high short-circuit current capacity that may cause severe burns and electrical arcing.**

Before working with any live battery or power system, follow these precautions:

- Remove all metallic jewelry, such as watches, rings, metal rimmed glasses, or necklaces
- Wear safety glasses with side shields at all times during the installation.
- Use OSHA approved insulated hand tools.



### WARNING!

---

**Lethal voltages are present within the power system. Always assume that an electrical connection or conductor is energized. Check the circuit with a voltmeter with respect to the grounded portion of the enclosure (both AC and DC) before performing any installation or removal procedure.**

- Do not work alone under hazardous conditions.
- A licensed electrician is required to install permanently wired equipment. Input voltages can range up to
- 240 Vac. Ensure that the utility power is disconnected and locked out before performing any installation or removal procedure.
- Ensure that no liquids or wet clothes come into contact with internal components.
- Hazardous electrically live parts inside this unit are energized from the batteries even when the AC input power is disconnected.

## Battery Safety

- Servicing and connection of batteries must be performed by, or under the direct supervision of, personnel knowledgeable of batteries and the required safety precautions.
- Always wear eye protection, rubber gloves, and a protective vest when working near batteries. Remove all metallic objects from your hands and neck.
- Use OSHA approved insulated hand tools. Do not rest tools on top of batteries.
- Batteries contain or emit chemicals known to cause cancer and birth defects or other reproductive harm.
- Battery post terminals and related accessories contain lead and lead compounds. Wash your hands after handling batteries.



### WARNING!

---

**Follow battery manufacturer's safety recommendations when working around battery systems. Do not smoke or introduce an open flame when batteries (especially vented batteries) are charging. When charging, batteries vent hydrogen gas, which can explode.**

- Batteries are hazardous to the environment and should be disposed at a recycling facility. Consult the battery manufacturer for recommended local authorized recyclers.

# Sécurité

**CONSERVEZ CES INSTRUCTIONS:** Le présent manuel contient des consignes de sécurité importantes à suivre pendant l'installation, l'entretien et la maintenance du produit. Rangez-le dans un endroit sûr. Examinez les schémas et illustrations contenus dans ce manuel avant de poursuivre. En cas de questions sur l'installation ou le fonctionnement en toute sécurité de ce produit, contactez Alpha and Outback Energy GmbH ou le représentant d'AOE e plus près. Conservez ce document pour référence future.

## Symboles de Sécurité

Pour réduire le risque de blessures ou d'accident mortel et assurer le maintien de conditions d'exploitation sécuritaires de ce produit, les symboles ci-après ont été utilisés systématiquement dans ce manuel. Lorsque ces symboles sont utilisés, prenez des précautions supplémentaires.

L'utilisation du symbole « ATTENTION » indique l'existence d'exigences réglementaires ou normatives qui peuvent affecter l'emplacement de l'équipement ou les procédures d'installation.

### REMARQUE:

Une **REMARQUE (NOTE)** fournit des informations supplémentaires destinées à aider à la réalisation d'une tâche ou d'une procédure spécifique.



### PRUDENCE !

Le symbole **PRUDENCE (CAUTION)** indique une information de sécurité destinée à **ÉVITER DES DOMMAGES** au matériel ou à l'équipement. Ce symbole est représenté par une icône de danger de décharge électrique, le terme **PRUDENCE** et une ligne en dessous de laquelle l'information est affichée.



### AVERTISSEMENT!

Le symbole **AVERTISSEMENT (WARNING)** donne des informations sur la sécurité permettant au personnel d'**ÉVITER DES BLESSURES OU DES ACCIDENTS MORTELS**. Les avertissements sont identifiés par une icône de danger de décharge électrique, le terme **AVERTISSEMENT** et une ligne en dessous de laquelle l'information est affichée.



### CHAUD!

Le symbole **CHAUD (HOT)** est associé à des informations de sécurité destinées à **ÉVITER DES BRÛLURES** au technicien ou à l'utilisateur.

## Avertissements et Mises en Garde D'ordre Général



### AVERTISSEMENT !

**Ce système est conçu pour être installé dans un endroit restreint inaccessible au public.**

## Sécurité Mécanique

- Gardez les mains et les outils à l'écart des ventilateurs. Les ventilateurs sont thermostatés et s'allument automatiquement.
- Les blocs d'alimentation peuvent atteindre des températures extrêmes lorsqu'ils sont sous tension.
- Procédez avec prudence autour des composants en tôle et des bords tranchants.

# Sécurité Electrique



## AVERTISSEMENT !

---

**Des tensions dangereuses sont présentes à l'entrée des systèmes électriques. La sortie CC des redresseurs et des batteries, bien que non dangereuse en termes de tension, a une capacité de courant de court-circuit élevée qui peut causer de graves brûlures et des arcs électriques.**

Avant de travailler sur une batterie ou un système électrique alimenté(e), suivez ces précautions :

- Retirez tout bijou métallique, tel qu'une montre, une alliance, des montures métalliques ou un collier.
- Portez des lunettes de sécurité avec des écrans latéraux de protection à tout moment durant l'installation.
- Utilisez des outils à mains isolés et approuvés par OSHA.



## AVERTISSEMENT !

---

**Des tensions mortelles sont présentes dans le système électrique. Considérez toujours une connexion électrique ou un conducteur comme étant sous tension. Vérifiez le circuit avec un voltmètre au niveau de la partie mise à la terre du boîtier (CA et CC) avant de lancer une procédure d'installation ou de retrait.**

- Ne travaillez pas seul lorsque les conditions sont dangereuses.
- Un électricien agréé est requis pour installer un équipement câblé de façon permanente. Les tensions d'entrée peuvent atteindre
- 240 V CA. Assurez-vous que l'électricité de service est débranchée et verrouillée avant de lancer une procédure d'installation ou de retrait.
- Assurez-vous qu'aucun liquide ou vêtement mouillé n'entre en contact avec les composants internes.
- Les pièces électriques dangereuses à l'intérieur de cette unité sont alimentées par les batteries même lorsque l'alimentation CA en entrée est débranchée.

## Sécurité de la Batterie

- L'entretien et la connexion des batteries doivent être effectués par un spécialiste des batteries ou sous la supervision directe d'un tel spécialiste, en prenant les précautions de sécurité requises.
- Portez toujours une protection pour les yeux, des gants en caoutchouc et un gilet de protection lorsque vous travaillez à proximité de batteries. Retirez tous les objets métalliques de vos mains et de votre coup.
- Utilisez des outils à main isolés et approuvés par OSHA. Ne déposez pas les outils sur les batteries.
- Les batteries contiennent ou émettent des produits chimiques identifiés comme cause de cancer et de malformations congénitales ou d'autres troubles de l'appareil reproducteur. Les bornes des batteries et leurs accessoires contiennent du plomb et des composés de plomb. Lavez-vous les mains après avoir manipulé des batteries.



## AVERTISSEMENT !

---

**Observez les recommandations de sécurité du fabricant quand vous travaillez avec des systèmes de batteries. Ne fumez pas, ou n'introduisez pas de flamme nue quand les batteries (surtout les batteries ouvertes) sont en cours de charge. En cours de charge, les batteries dégagent de l'hydrogène gazeux susceptible d'exploser.**

- Les batteries sont néfastes pour l'environnement et doivent être mises au rebut dans un centre de recyclage. Consultez le fabricant de la batterie pour connaître les centres de recyclages agréés locaux.

# Seguridad

**GUARDE ESTAS INSTRUCCIONES:** Este manual contiene instrucciones de seguridad importantes que deben seguirse durante la instalación, reparación y mantenimiento del producto. Manténgalas en un lugar seguro. Inspeccione los dibujos y las ilustraciones contenidas en este manual antes de continuar. Si existe cualquier pregunta relacionada con la instalación u operación segura de este producto, póngase en contacto con Alpha and Outback Energy GmbH o con su representante de AOE más cercano. Guarde este documento para referencia futura.

## Símbolos de Seguridad

Para reducir el riesgo de lesión o muerte y para asegurar la operación continua segura de este producto, se han colocado los siguientes símbolos a lo largo de este manual. En las partes donde aparecen estos símbolos, preste atención y cuidado adicional.

### Atención:

El uso de ATENCIÓN indica requisitos de código o regulatorios específicos que pueden afectar la ubicación del equipo y/o los procedimientos de instalación.

### NOTA:

Una NOTA (NOTE) provee información adicional para ayudar a completar una tarea o un procedimiento específico.



### ¡CUIDADO!

**CUIDADO (CAUTION)** indica información de seguridad con el propósito de **PREVENIR DAÑOS** al material o al equipo. Los avisos de cuidado están designados con un icono de peligro de choque, la palabra **CUIDADO** y una línea debajo de la cual aparece la información.



### ¡ADVERTENCIA!

Una **ADVERTENCIA (WARNING)** presenta información de seguridad para **PREVENIR LESIÓN O MUERTE** al personal. Las advertencias se indican con un icono de peligro de choque, la palabra **ADVERTENCIA** y una línea debajo de la cual aparece la información.



### ¡CALIENTE!

El uso de **CALIENTE (HOT)** presenta información de seguridad para **PREVENIR QUEMADURAS** al técnico o al usuario.

## Seguridad General



### ¡ADVERTENCIA!

**Este sistema está diseñado para instalarse en una ubicación con acceso restringido que no sea accesible para el público general.**

## Seguridad Mecánica

- Mantenga las manos y las herramientas alejadas de los ventiladores. Los ventiladores están controlados de forma termostática y se encienden automáticamente.
- Las fuentes de alimentación pueden alcanzar temperaturas extremas bajo carga.
- Tenga cuidado cerca de bordes filosos y componentes de chapa.

## Seguridad Eléctrica



### **¡ADVERTENCIA!**

**Hay voltajes peligrosos en la entrada de los sistemas de alimentación. La salida de CC de rectificadores y baterías, si bien no es peligrosa en cuanto al voltaje, cuenta con una alta capacidad de conducción de cortocircuito que puede causar quemaduras graves y arcos eléctricos.**

Antes de trabajar con una batería activa o un sistema de alimentación, siga estas precauciones:

- Qúitese toda joyería metálica, como relojes, anillos, anteojos con montura de metal o collares.
- Use antiparras de seguridad con protecciones laterales en todo momento durante la instalación.
- Use herramientas manuales aisladas aprobadas por OSHA.



### **¡ADVERTENCIA!**

**El sistema de alimentación presenta voltajes mortales en su interior. Suponga siempre que las conexiones o los conductores eléctricos están energizados. Revise el circuito con un voltímetro con respecto de la porción a tierra del cerramiento (tanto CA como CC) antes de realizar cualquier procedimiento de instalación o remoción.**

- No trabaje solo en condiciones peligrosas.
- Se requiere que un electricista matriculado se ocupe de instalar equipos con conexión permanente. Los voltajes de entrada pueden llegar a los 240 VCA. Asegúrese de que la fuente de alimentación eléctrica del servicio esté desconectada y bloqueada antes de realizar un procedimiento de instalación o remoción.
- Asegúrese de que ningún líquido ni ropa húmeda en contacto con los componentes internos.
- Las partes eléctricamente activas peligrosas dentro de esta unidad están energizadas por las baterías incluso cuando se desconecta la alimentación de entrada de CA.

## Seguridad de la Batería Externa

- El mantenimiento y la conexión de las baterías debe ser realizado por, o bajo la supervisión directa de, personal experto en baterías y tomando las precauciones de seguridad requeridas.
- Siempre que trabaje con baterías utilice protección para los ojos, guantes de goma y un chaleco protector. Qúitese todos los objetos metálicos de las manos y el cuello.
- Use herramientas manuales aisladas aprobadas por OSHA. No apoye las herramientas sobre las baterías.
- Las baterías contienen o emiten elementos químicos que causan cáncer y defectos de nacimiento u otros problemas reproductivos.
- Los terminales de batería y accesorios similares contienen plomo y compuestos del plomo. Lávese las manos después de manipular baterías.



### **¡ADVERTENCIA!**

**Siga las recomendaciones del fabricante de las baterías cuando trabaje cerca de sistemas de baterías. No fume ni introduzca una llama abierta cuando las baterías (en especial las baterías ventiladas) se están cargando. Mientras se cargan, las baterías ventilan gas hidrógeno que puede explotar.**

- Las baterías son peligrosas para el medioambiente y deben desecharse en un centro de reciclado. Consulte al fabricante de las baterías acerca de centros de reciclado autorizados locales recomendados.



# Wichtige Sicherheitshinweise

**BEWAHREN SIE DIESE ANWEISUNGEN AUF:** Dieses Handbuch enthält wichtige Sicherheitshinweise, die bei der Installation, Wartung und Instandhaltung des Produkts beachtet werden müssen. Bewahren Sie es an einem sicheren Ort auf. Sehen Sie sich die Zeichnungen und Illustrationen in diesem Handbuch genau an, bevor Sie fortfahren. Sollten Sie Fragen zur sicheren Installation oder zum Betrieb dieses Produkts haben, wenden Sie sich bitte an Alpha and Outback Energy GmbH oder den nächstgelegenen AOE-Vertreter. Bewahren Sie dieses Dokument für den zukünftigen Gebrauch auf.

## Sicherheitssymbole

Um das Risiko von Verletzungen oder Todesfällen zu reduzieren und den weiteren sicheren Betrieb dieses Produkts zu gewährleisten, wurden in diesem Handbuch die folgenden Symbole verwendet. Seien Sie besonders vorsichtig und aufmerksam, wenn diese Symbole abgebildet sind.

Das Symbol VORSICHT (ATTENTION) deutet auf spezifische Anforderungen von aufsichtsrechtlichen Vorschriften oder Normen hin, welche Einfluss auf die Platzierung von Geräten und/oder Installationsverfahren haben können.

### HINWEIS:

---

Ein HINWEIS (NOTE) liefert zusätzliche Informationen, die Ihnen helfen, eine bestimmte Aufgabe zu lösen bzw. ein bestimmtes Verfahren durchzuführen. Hinweise sind mit einem Häkchen, dem Wort HINWEIS und einem Strich, unter dem die Informationen aufgeführt sind, gekennzeichnet.



### ACHTUNG!

---

ACHTUNG (CAUTION) kennzeichnet Sicherheitsinformationen, die darauf abzielen, SCHÄDEN an Materialien oder Geräten ZU VERHINDERN. Diese Warnhinweise sind mit einem gelben Warndreieck, dem Wort ACHTUNG und einem Strich, unter dem die Informationen aufgeführt sind, gekennzeichnet.



### WARNUNG!

---

Eine WARNUNG (WARNING) enthält Sicherheitsinformationen zur VERHINDERUNG VON VERLETZUNGEN ODER TODESFÄLLEN bei Mitarbeitern. Diese Warnhinweise sind mit einem Stromschlagsymbol, dem Wort WARNUNG und einem Strich, unter dem die Informationen aufgeführt sind, gekennzeichnet.



### HEISS!

---

Die Warnung HEISS! (HOT) liefert Sicherheitsinformationen, die dazu dienen, VERBRENNUNGEN des Technikers oder Benutzers zu VERHINDERN.

## Allgemeine Sicherheit



### WARNUNG!

---

Dieses System wurde für eine Aufstellung an einem Standort mit Zugangsbeschränkung entworfen, der für die allgemeine Öffentlichkeit nicht zugänglich ist.

## Mechanische Sicherheit

- Achten Sie darauf, dass Hände und Werkzeuge nicht mit den Lüftern in Berührung kommen. Die Lüfter werden thermostatisch kontrolliert und schalten sich automatisch ein.
- Die Netzteile können unter Last Extremtemperaturen erreichen.
- Gehen Sie in der Nähe von Blechteilen und scharfen Kanten vorsichtig vor.

## Elektrische Sicherheit



### WARNUNG!

---

**Am Punkt der Stromeinspeisung liegen gefährliche Spannungen vor. Der Gleichstromausgang von Gleichrichtern und Batterien weist zwar keine gefährliche Spannung auf, die Kurzschlussstrom-Kapazität ist jedoch sehr hoch, was zu ernsthaften Verbrennungen und Lichtbögen führen kann.**

Befolgen Sie die folgenden Vorsichtsmaßnahmen, bevor Sie mit einer spannungsführenden Batterie oder einem Stromversorgungssystem arbeiten:

- Legen Sie sämtlichen Schmuck aus Metall wie z.B. Armbanduhren, Ringe, Brillen mit Metallrahmen oder Halsketten ab.
- Tragen Sie während der Installationsarbeiten jederzeit Schutzbrillen mit Seitenschutz.
- Verwenden Sie nur geprüftes isoliertes Werkzeug.



### WARNUNG!

---

**Innerhalb des Stromversorgungssystems herrschen lebensgefährliche Spannungen vor. Gehen Sie jederzeit davon aus, dass eine elektrische Verbindung oder ein Leiter Strom führt. Überprüfen Sie den Stromkreis mit einem Spannungsmesser bezüglich des geerdeten Teils des Gehäuses (sowohl Wechsel- als auch Gleichstrom), bevor Sie eine Installation oder Demontage durchführen.**

- Arbeiten Sie unter gefährlichen Bedingungen niemals alleine.
- Die Installation festverdrahteter Geräte muss durch einen zugelassenen Elektriker vorgenommen werden. Die Eingangsspannungen können bis zu 240 VAC betragen. Stellen Sie sicher, dass die Verbindung zum Netzstrom getrennt und gegen Wiedereinschalten gesichert ist, bevor Sie eine Installation oder Demontage durchführen.
- Stellen Sie sicher, dass keine Flüssigkeiten oder nasse Kleidungsstücke mit innenliegenden Komponenten in Berührung kommen.
- Gefährliche stromführende Teile innerhalb dieses Geräts werden auch bei Trennung der Netzverbindung noch über die Batterien versorgt.

## Batteriesicherheit

- Die Wartung und der Anschluss von Batterien muss von Mitarbeitern durchgeführt bzw. direkt beaufsichtigt werden, die über Kenntnisse über Batterien und die erforderlichen Sicherheitsmaßnahmen verfügen.
- Tragen Sie jederzeit Augenschutz, Gummihandschuhe und eine Schutzweste, wenn Sie in der Nähe von Batterien arbeiten. Entfernen Sie sämtliche Metallgegenstände von Ihren Händen und Ihrem Hals.
- Verwenden Sie von der OSHA genehmigte isolierte Handwerkzeuge. Legen Sie Werkzeuge nicht auf Batterien ab.
- Verwenden Sie nur geprüftes isoliertes Werkzeug. Legen Sie Werkzeug niemals auf Batterien ab.
- Batterien enthalten Chemikalien bzw. setzen Chemikalien frei, von denen bekannt ist, dass sie Krebs oder Geburtsfehler verursachen oder die Fortpflanzungsfähigkeit anderweitig schädigen.
- Batterieanschlüsse und entsprechendes Zubehör enthalten Blei und Bleiverbindungen. Waschen Sie nach dem Umgang mit Batterien Ihre Hände.
- verursachen oder die Fortpflanzungsfähigkeit anderweitig schädigen.



### WARNUNG!

---

**Befolgen Sie die Sicherheitsempfehlungen von Batterieherstellern, wenn Sie mit Batteriesystemen arbeiten. Während Batterien (insbesondere geschlossene Batterien) aufgeladen werden, darf weder geraucht noch offenes Feuer verwendet werden. Beim Aufladen setzen Batterien Wasserstoffgas frei, das explodieren kann.**

- Batterien sind schädlich für die Umwelt und sollten im Sondermüll entsorgt werden. Wenden Sie sich an den Batteriehersteller, um sich über empfohlene zugelassene örtliche Recyclingstellen zu informieren.

# TABLE OF CONTENTS

<b>1</b>	<b>INTRODUCTION</b> .....	<b>1</b>
1.1	Scope of the Manual.....	1
1.2	Product Overview .....	1
1.3	Part Numbers and List Options .....	3
<b>2</b>	<b>FEATURES</b> .....	<b>4</b>
2.1	Converter Module .....	4
2.2	Cordex Integrated System Controller (CXCI/CXCI+) Option .....	5
2.3	System Controller Front Panel.....	5
2.4	Analog Input Channels .....	7
2.5	Digital Input Channels .....	7
2.6	Alarm and Control Output Relays .....	7
2.7	Network Connection and Remote Communications .....	7
<b>3</b>	<b>INSPECTION</b> .....	<b>8</b>
3.1	Packing Materials .....	8
3.2	Check for Damage.....	8
<b>4</b>	<b>INSTALLATION</b> .....	<b>9</b>
4.1	Safety Precautions .....	9
4.2	Tools Required .....	9
4.3	Shelf Preparation/Mounting .....	9
4.4	Converter Module Insertion/Removal .....	9
4.5	Installing a CXCI/CXCI+ .....	10
<b>5</b>	<b>WIRING AND CONNECTIONS</b> .....	<b>13</b>
5.1	Safety Precautions .....	13
5.2	Calculating Wire Size Requirements .....	13
5.3	Input/Output Connections .....	13
5.4	CAN Serial Ports .....	14
5.5	Network Connection and Remote Communications via CXCI/CXCI+ .....	14
5.6	Signal Wiring Connections for CXCI/CXCI+ .....	15
<b>6</b>	<b>SYSTEM STARTUP</b> .....	<b>17</b>
6.1	Check System Connections .....	17
6.2	Power the Converter Shelf.....	17
6.3	Converter Operation and Programming via the CXC .....	17
6.4	CXC Reset.....	18
<b>7</b>	<b>MAINTENANCE</b> .....	<b>19</b>
7.1	Fan Replacement .....	19
7.2	CXCI/CXCI+ Replacement Procedure.....	20
<b>8</b>	<b>WARRANTY</b> .....	<b>24</b>
8.1	Warranty .....	24
<b>9</b>	<b>ACRONYMS AND DEFINITIONS</b> .....	<b>25</b>

## FIGURES

Figure 1–Perspective view of CXDF 24-48/2kW converter module .....	1
Figure 2–Cordex CXCI model system controller front panel .....	5
Figure 3–Cordex CXCI+ model system controller front panel .....	6
Figure 4–Showing CXCI/CXCI+ blank plate removal .....	10
Figure 5–Showing CXCI+ controller module installation .....	11
Figure 6–Baffle and pem removal .....	11
Figure 7–Showing CXCI module preparation .....	12
Figure 8–Showing CXCI module installation .....	12
Figure 9–Showing relay connections .....	15
Figure 10–Showing digital input connection method .....	15
Figure 11–Location of LVD bypass jumper .....	20
Figure 12–Showing CXCI (original design) replacement detail .....	21
Figure 13–Cordex CXCI+ controller module.....	22

# 1 Introduction

## 1.1 Scope of the Manual

This instruction manual explains the installation and interconnection of Alpha Technologies' CXDF 24-48/2kW. Both the converter modules and the shelves, which the modules are plugged into, are covered in this manual.

**NOTE:** *To aid the user with installation, frequent reference is made to foldout drawings located at the rear of the manual.*

The following documents and drawings are included in this manual to provide the necessary information required for installation, routine operation and fault diagnosis of the unit:

- Specifications, Converter and Shelf: 012-526-B1
- Specifications, CXCI/CXCI+: 7400233-S0
- Outline Drawing, 23" 5-Module Shelf: 030-900-06
- Customer Connections, 23" 5-Module Shelf: 030-900-08
- Outline Drawing, 19" 4-Module Shelf: 030-905-06
- Customer Connections, 19" 4-Module Shelf: 030-905-08
- Outline Drawing, 19" Shelf, Dual Input: 030-839-06
- Customer Connections, 19" Shelf, Dual Input: 030-839-08

## 1.2 Product Overview

The CXDF 24-48/2kW isolated DC-DC converter employs a high frequency switched mode conversion technique to provide a fully regulated and isolated -48 Volt DC output from a +24 Volt DC input.

Each module is a stand-alone converter element, which plugs into a common shelf. The shelf provides external connections for input, output, and alarm interfaces. Additional converter modules can increase the current capacity and redundancy of the converter system.



**Figure 1—Perspective view of CXDF 24-48/2kW converter module**

The converter system consists of at least one shelf with one or more modules installed in each shelf. Additional modules can be added to the shelf at time of ordering or at a later time after the system has been installed.

The shelf converter system is designed to operate with the Alpha Cordex System Controller (CXC).

All models of the CXC allow the user to set up, control and monitor the entire power system and ancillary components from one central, easy-to-use source: your web browser. Other features of the controller include temperature compensation, auto equalization, remote access, dial out on alarm, battery diagnostics, as well as web server and SNMP support for configuration and monitoring.

***Details of controller operation are provided in the current version software manual.***

There are two external CXC models that can communicate with the converter shelf via offset RJ-12 shelf connectors. The CXCR is mounted in a rack and the CXCP is (factory) mounted in a panel. Each of these models has a touch screen display, similar to that used in a Personal Digital Assistant (PDA).

***See manual #018-587-B2 (pre-RoHS #018-557-B2).***

The optional shelf-mounted integrated model (CXCI/CXCI+) does not have a touch screen; therefore, system setup and management is performed exclusively with the web interface.

***Details for installation and wiring are provided in the respective chapters of this documentation package.***

### 1.3 Part Numbers and List Options

This product is available to order under the following part numbers and list options:

Description	Part Number/List Option
Cordex DC/DC 2kW converter, 24V In – 48V Out .....	012-526-20
Basic module .....	*List 0
Charcoal finish with white (contrasting) silkscreen .....	*List 56
Cordex DC/DC 2kW converter, 24V In – 48V Out, 23" (flush mounting) 2RU shelf.....	030-900-20
[may be equipped with one CXCI/CXCI+ controller and up to five CXDF 24-48/2kW converters].....	*List 0
23" rack, 6" offset mounting .....	List 24
Charcoal finish with white (contrasting) silkscreen .....	*List 56
Module blank plate.....	List 90
CXCI/CXCI+ blank plate .....	*List 91
Rear cover, Kydex .....	List 92
CXCI+ controller.....	*List 98
Cordex DC/DC 2kW converter, 24V In – 48V Out, 19" (flush mounting) 2RU shelf.....	030-905-20
[may be equipped with one CXCI/CXCI+ controller and up to four CXDF 24-48/2kW converters].....	*List 0
19" rack, 6" offset mounting .....	List 19
23" rack, 6" offset mounting .....	List 24
Charcoal finish with white (contrasting) silkscreen .....	*List 56
Module blank plate.....	List 90
CXCI/CXCI+ blank plate .....	*List 91
Rear cover, Kydex .....	List 92
CXCI+ controller.....	*List 98
Cordex DC/DC 2kW converter, 24V In – 48V Out, 19" (flush mounting) 2RU shelf.....	030-839-20
[may be equipped with one CXCI/CXCI+ controller and up to four CXDF 24-48/2kW converters].....	*List 0
19" rack, 6" offset mounting .....	List 19
23" rack, 6" offset mounting .....	List 24
Charcoal finish with white (contrasting) silkscreen .....	*List 56
Output adapters (DC cable), right angle .....	List 82
Module blank plate.....	List 90
CXCI/CXCI+ blank plate .....	*List 91
Rear cover, Kydex .....	List 92
CXCI+ controller.....	*List 98
Output adapters (DC cable) kit, right angle, CXDF 19" shelf .....	058-245-20
Rear cover kit, CXDF 19" shelf, Kydex .....	747-587-20
Replacement CXDF fan assembly.....	747-362-20
Replacement CXCI+ controller .....	7400232-001
CXCI/CXCI+ I/O terminal block kit (for external connections).....	**036-201-20
Cordex DC Modem (complete with Alpha cable) .....	018-585-20

\* Default option

\*\* See drawings at the rear of this manual.

*The above information is valid at the time of publication. Consult factory for up-to-date ordering information.*

## 2 Features

### 2.1 Converter Module

The Cordex converter modules plug into the Cordex converter shelf. The modules can be installed or removed from a system without disturbing the system provided sufficient current capacity remains. This is often referred to as “Hot Swap.”

The total output current capacity of the converter system is equal to the sum of the individual current capacities of the converter modules.

#### 2.1.1 Alarms

**Converter Module Fail** alarms consist of a group of (major) alarm conditions that are considered “serious” or an immediate threat to service:

- Converter failure
- Output fuse failure
- Converter off
- Thermal shutdown
- Input Voltage is out of range
- Output OVP level has been exceeded.

**Converter Minor** alarms consist of a group of alarm conditions that are not an immediate threat to service:

- Fan fail
- Current limit.

#### 2.1.2 Indicators

LED indicators are provided on the front panel of the converter module to display the operational status of the module (see Table 1).

Indicator Color	Associated Condition
Green (I/P)	DC INPUT OK
Green (O/P)	Converter Module Power ON
Red (FAIL)	Converter Module FAIL
Red (FAIL flashing)	Converter Minor Alarm

**Table 1 Module indicators and conditions**

#### 2.1.3 Regulation and Paralleling

Cordex modular converters use “output slope” or “regulation offset” to accomplish load sharing. When the converters are run in parallel (as is the case when more than one converter module is installed in the shelf) it is necessary to adjust (via the CXC) the output voltage of the individual converter modules such that the output current is shared equally between the individual modules. At that point, the modules will track each other and share the load over the output current range of the units. The output slope value is fixed at 1.0% (1V / full current range).

#### 2.1.4 Reverse Polarity Protection

The converter design has incorporated reverse polarity protection from the connection to a battery on the input and to a power source on the output. This prevents damage to the converter circuitry if a reverse connection is made.



## 2.2 Cordex Integrated System Controller (CXCI/CXCI+) Option

The CXCI/CXCI+ option is mounted in the converter system shelf and brings advanced monitoring technology to the Cordex series of converters. This compact system controller is designed for seamless operation and set up of Alpha power systems and is equipped with the complete range of Cordex software features, including the following:

- Designed to communicate directly with Cordex converters
- Provides local and remote communications
- User definable alarms
- Daily logging of system events and statistics.

Behind the CXCI/CXCI+'s front panel lies the main controller motherboard, which contains a microprocessor, memory, as well as numerous other electronic components.

The CXCI/CXCI+ includes a web server providing easy set up and monitoring using an Internet connection with the standard Windows® Explorer browser.

The data logging feature allows the user to capture data from multiple inputs, for AC/DC voltages, load/battery current, cell voltages & temperatures (automatically for up to 16 user defined logs). Typical applications of the CXCI/CXCI+ logging include power system details, thermal performance of outdoor enclosures, battery cell specifics, or mains variations captured by an AC voltage watchdog.

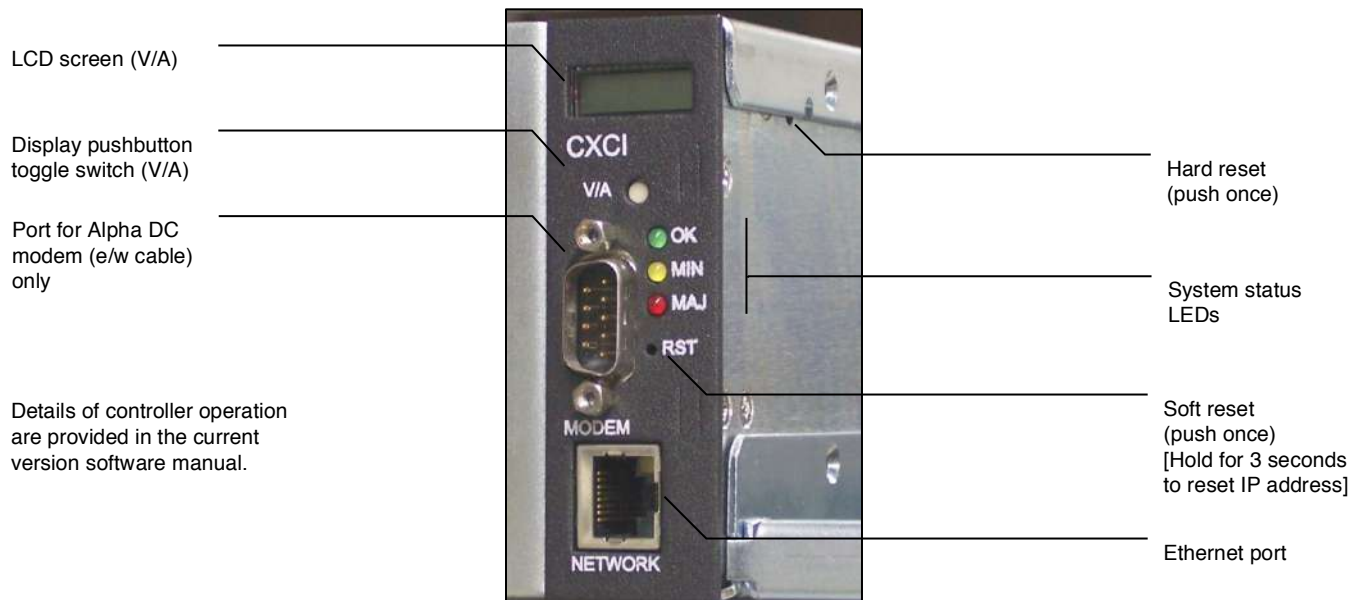
A built-in audio speaker sounds an intermittent tone during active alarms.

The input/output (I/O) board houses a series of terminal connections; located at the rear of the system shelf via a D-sub connector.

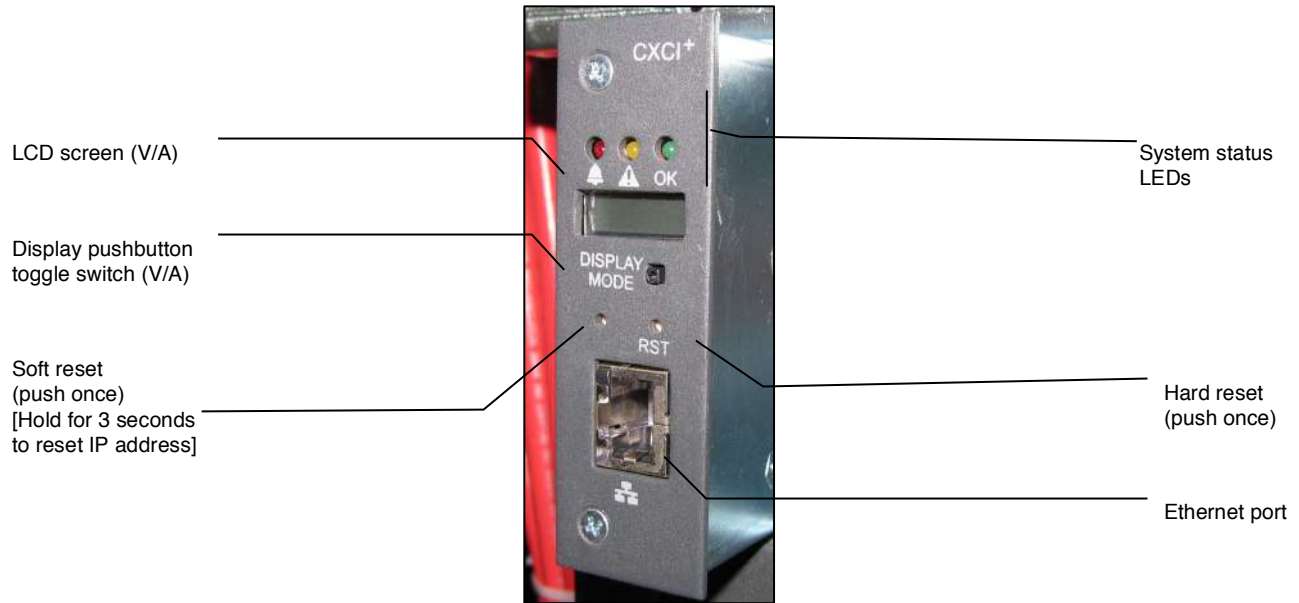
**NOTE:** *Customer settings for the CXCI/CXCI+ will be provided separately in the system documentation package.*

## 2.3 System Controller Front Panel

The CXCI (Figure 2) and the CXCI+ (Figure 3) controllers have a 4-digit display, for monitoring system voltage (V) and current (A). A pushbutton toggle switch allows the user to alternate the display reading.



**Figure 2–Cordex CXCI model system controller front panel**



**Figure 3–Cordex CXCI+ model system controller front panel**

## 2.3.1 LEDs

The CXC has three LEDs located on the front panel. These are used to display the alarm status of the power system, CXC progress and status during startup, and file transfers.

### 2.3.1.1 Alarm Conditions

The CXCI/CXCI+ illuminates the LED that corresponds to the system alarm status. The following show the corresponding alarm status for each LED color:

**Green** – OK, no alarms present

**Yellow** – Minor alarm is present (no major alarms)

**Red** – Major alarm is present.

Only one LED is illuminated at a time during alarm conditions.

### 2.3.1.2 Progress and Status Indication

The LEDs are also used in the following situations:

**Base unit validation** – all three LEDs are on at the same time.

**File transfer** – when recovering from invalid firmware application – the red LED is illuminated.

## 2.3.2 Reset

A reset button is located on the front panel for restarting the CXCI/CXCI+'s microprocessor.

**NOTE:** Refer also to the software manual – always select the Reset menu item before pressing the reset button.

## 2.3.3 Modem Port (not available on the CXCI+, list 98)

The Modem port (front panel DB-9 connector, Figure 2) is designed for connection to Alpha Technologies' Cordex DC Modem #018-585-20.

## 2.3.4 CAUTION Ethernet Port

The Ethernet port is designed for CXCI/CXCI+ connection to a user supplied network (TCP/IP secured by user) via a front panel RJ-45 jack and a standard network cable.

Local access (e.g. laptop computer) is also possible from the Ethernet port connection using a standard network crossover cable.

## **2.4 Analog Input Channels**

### **2.4.1 Voltage Inputs**

Two voltage input channels, V1 and V2, provide monitoring of discharge and charge voltage. The CXCI/CXCI+ software is pre-configured to monitor V2 for load and for battery voltage. V2 is used as the system reference for rectifier float voltage, low voltage disconnect (LVD), system high voltage alarm, and system low voltage alarm. V1 is available for additional voltage measurements.

### **2.4.2 Current Input**

The CXCI/CXCI+ software is pre-configured to monitor I1 for load current using an external 100A/50mV current shunt in the negative lead.

### **2.4.3 Temperature Inputs**

Two temperature input channels, T1 and T2, provide monitoring of battery temperature and temperature compensation (temp comp) or room/ambient temperature. A voltage is supplied to these terminals to power the temperature sensors.

## **2.5 Digital Input Channels**

The CXCI/CXCI+ can accommodate up to two (2) channels and can monitor digital alarm/control signals from converters, rectifiers, and many other types of equipment.

## **2.6 Alarm and Control Output Relays**

The CXCI/CXCI+ contains four (4) Form C digital alarm output relays to extend alarms and control external apparatus. Each internally generated alarm or control signal may be mapped to any one of the relays, or, several signals may be mapped to just one relay or none at all.

## **2.7 Network Connection and Remote Communications**

The Cordex system can be set up, monitored and tested via Ethernet 10/100 Base-T serial data connection. The communication protocol supports a web interface. All alarming and control of Cordex converters is accomplished with a CXC via a CAN bus.

## 3 Inspection

### 3.1 Packing Materials

All Alpha products are shipped in rugged cardboard boxes and suspended via solid inserts to minimize shock that may occur during transportation. Packaging assemblies and methods are tested to International Safe Transit Association standards.

#### 3.1.1 Returns for Service

Save the original shipping container. If the product needs to be returned for service, it should be packaged in its original shipping container. If the original container is unavailable, make sure the product is packed with at least three inches of shock-absorbing material to prevent shipping damage.

**NOTE:** *Alpha Technologies is not responsible for damage caused by the improper packaging of returned products.*

### 3.2 Check for Damage

Prior to unpacking the product, note any damage to the shipping container. Unpack the product and inspect the exterior for damage. If any damage is observed contact the carrier immediately.

Continue the inspection for any internal damage. In the unlikely event of internal damage, please inform the carrier and contact Alpha Technologies for advice on the impact of any damage.



**Verify that you have all the necessary parts per your order for proper assembly.**

## 4 Installation

This chapter is provided for qualified personnel to install the product, which shall be mounted in a clean and dry environment.

**NOTE:** *To aid the user with installation, frequent reference is made to drawings located at the rear of the manual.*

### 4.1 Safety Precautions



#### **WARNING**

**Hazardous voltages are present at the input of converter/rectifier systems. The DC output, from the converters/rectifiers and the battery system, has a high short circuit current capacity that may cause severe burns and electrical arcing.**

Before working with any live battery or power system/distribution center, follow these precautions:

- Remove all metallic jewelry; e.g., watches, rings, metal rimmed glasses, necklaces.
- Wear safety glasses with side shields (and prescription lenses if necessary) at all times during installation.

The installer should follow all applicable local rules and regulations for electrical and battery installations; e.g., CSA, UL, CEC, NEC, OSHA, and local fire codes.

Use OSHA approved insulated hand tools.

### 4.2 Tools Required

Various insulated tools are essential for product installation. Use this list as a guide:

- Philips head screwdriver, #2 (tip size 1/4")
- Slot head screwdriver (1/4" x #6)
- Slot head screwdriver (blade size 0.09" x 0.02") or "tweaker"
- Digital voltmeter equipped with test leads
- Cutters and wire strippers
- Crimping tool (optional for large gauge wire)
- Socket and ratchet set (Imperial measure).

### 4.3 Shelf Preparation/Mounting



#### **WARNING**

**This system is designed to be installed in a restricted access location that is inaccessible to the general public.**

For 030-900-20, the shelf has been designed for flush mounting in a 23" relay rack.

For 030-905-20 and 030-839-20, the shelves have been designed for flush mounting in a 19" relay rack.

Each shelf has an option for 6" offset mounting. See outline drawings at the rear of this manual.

**NOTE:** *The shelf shall be mounted in a clean and dry environment. Allow at least 1.75" of free space in front of and behind the unit for unrestricted cooling airflow.*

Mounting brackets accommodate either 1" or 1-3/4" rack spacing. The shelf should be mounted to the rack using at least two #12 – 24 x 1/2" screws in each bracket. Philips-type screws and screwdriver should be used to eliminate the possibility of slippage and scratching of the unit's exterior. Washers (such as internal tooth) or special screws that are designed to cut through the painted surface should be used to ensure a good chassis ground.

### 4.4 Converter Module Insertion/Removal

Insert by placing the converter module on the shelf bottom and sliding the module into the rear connector (inside of the shelf). Apply pressure on the module handle to engage the rear connector in the shelf receptacle.

**NOTE:** *It is recommended that the first converter module be inserted into the front leftmost position using the side of the shelf-mounted controller as a guide. The next module may be inserted using the previous module as a guide.*

Tighten the thumbscrew (1/4-turn) latch on the bottom of the faceplate to secure the module to the shelf.

**NOTE:** Do not force a module into position if it does not seat properly. All modules are keyed to ensure that the correct module (polarity/voltage) type is used.

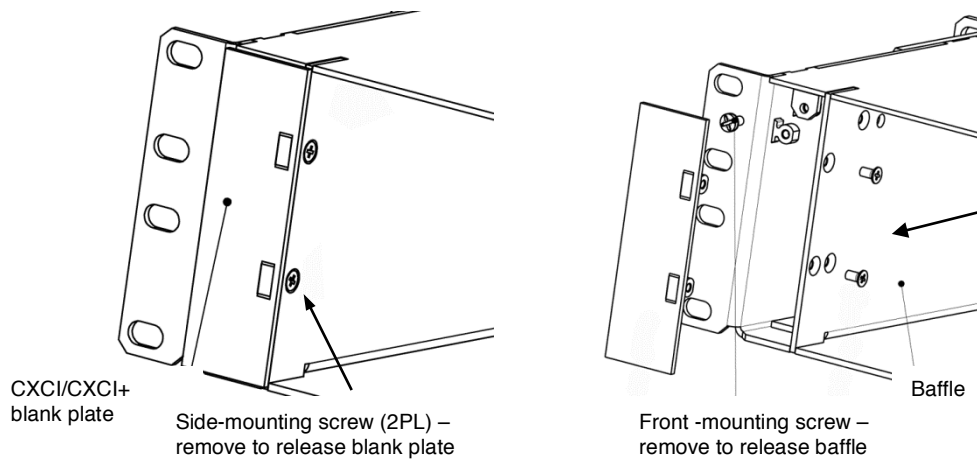
To remove a converter module, loosen the thumbscrew (1/4-turn) latch on the bottom of the faceplate. Grasp handle and pull out, sliding the module away from the rear connector and out of the shelf.

## 4.5 Installing a CXCI/CXCI+

Refer to Maintenance chapter for CXCI/CXCI+ replacement procedure.

### 4.5.1 CXCI/CXCI+ Blank Plate Removal

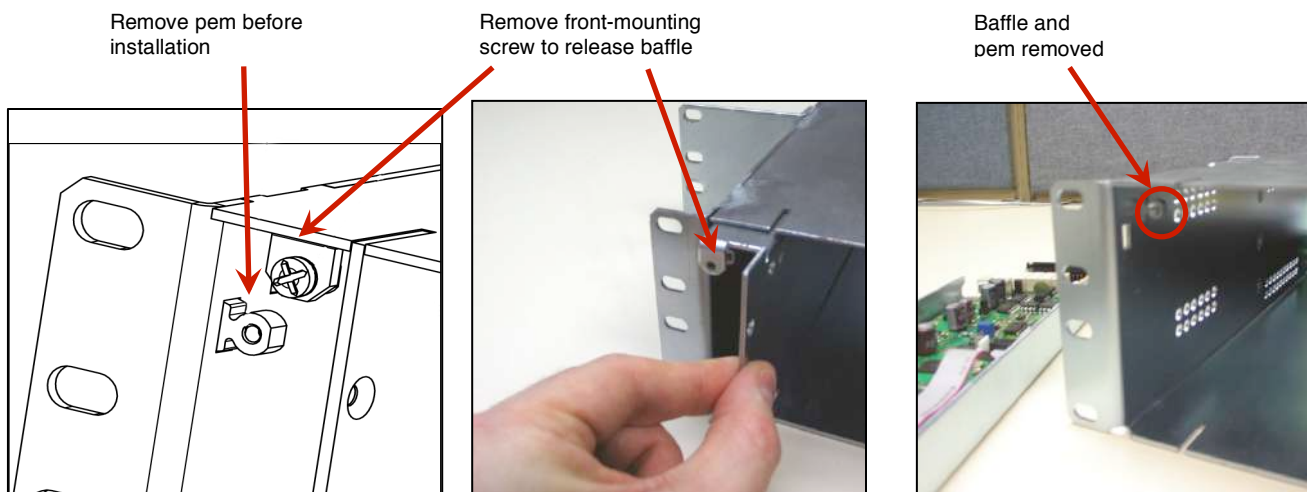
Remove converter in the left-most position in order to access the side of the CXCI/CXCI+ where the mounting screws are located.



**Figure 4—Showing CXCI/CXCI+ blank plate removal**

### 4.5.2 CXCI+ Module Installation

1. Remove the blank plate as described previously.
2. Remove baffle (via front-mounting screw) if you have not already done so.



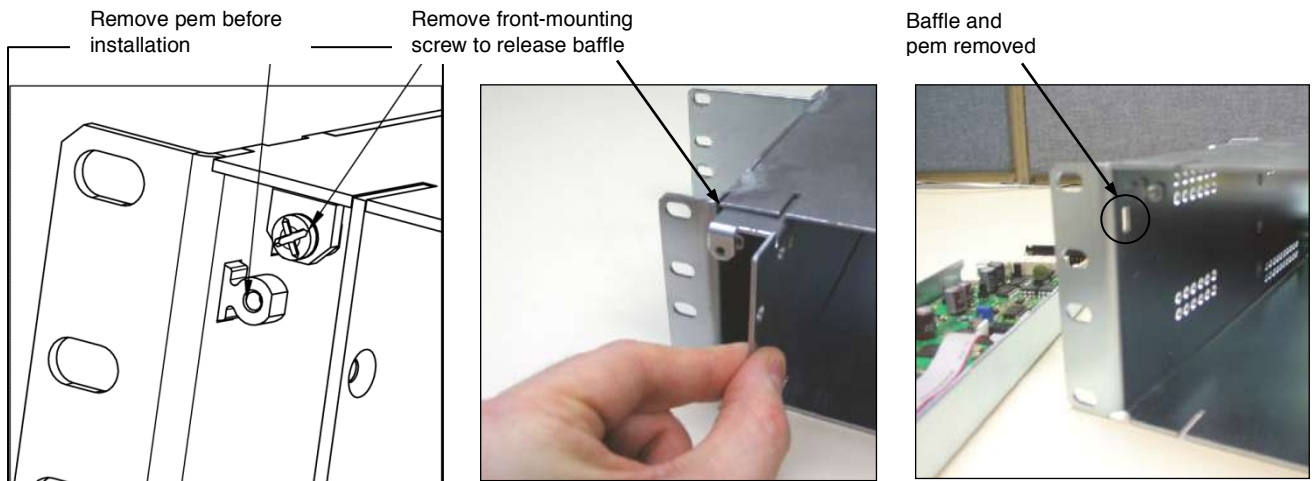
3. Place the CXCI+ controller module on the bottom of the shelf and slide into the rear connector at the back of the slot.



**Figure 5—Showing CXCI+ controller module installation**

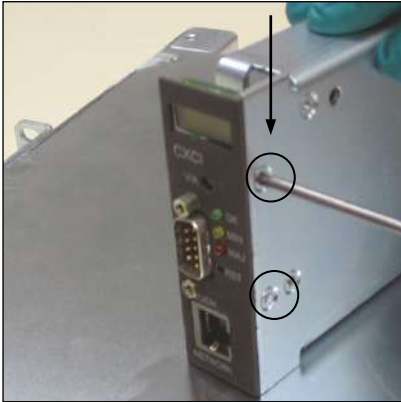
#### 4.5.3 CXCI Module Installation

1. Remove blank plate as described previously.
2. Remove baffle (via front-mounting screw) if you have not already done so.

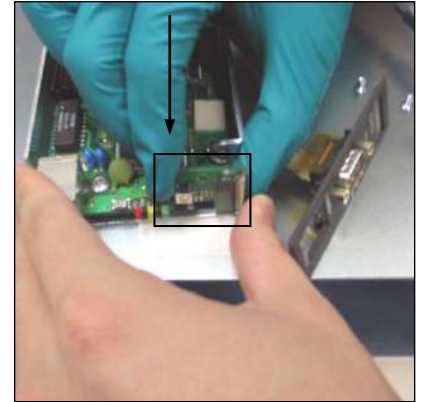


**Figure 6—Baffle and pem removal**

Remove two (2) side mounting screws to release the CXCI front panel

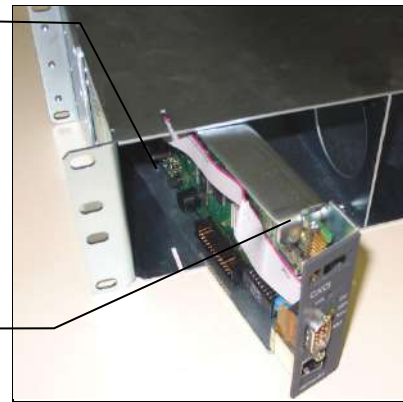


Gently remove LCD

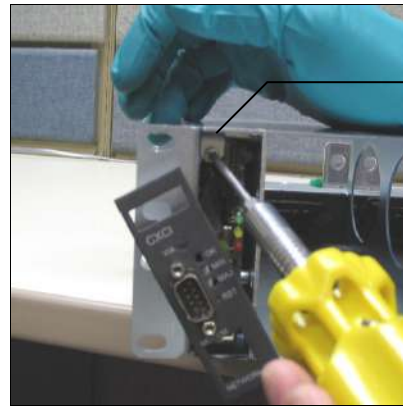


**Figure 7—Showing CXCI module preparation**

Install by placing the CXCI module on the shelf bottom and sliding the module into the rear connector (inside of the shelf)



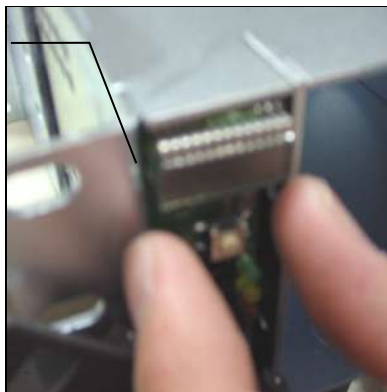
Apply pressure on the module baffle plate to engage the rear connector in the shelf receptacle



Install front mounting screw to secure body of CXCI module

Use minimal pressure to re-install the LCD

Ensure LCD is straight and aligned parallel to the front panel window when reattaching the CXCI front panel



Install two (2) side mounting screws to secure the CXCI front panel

**Figure 8—Showing CXCI module installation**



## 5 Wiring and Connections

This chapter provides cabling details and notes on cable sizing for DC applications.

**NOTE:** *Refer also to foldout drawings located at the rear of the manual.*

### 5.1 Safety Precautions



#### **WARNING**

**Ensure that power is removed by turning off rectifiers (if equipped) and removing the battery line fuse circuit breaker or connection before attempting work on the converter wiring connections.**

**For safety reasons, ensure the Cordex shelf is properly bonded to the building's ground grid.**

**NOTE:** *The input and output DC connections should be grounded appropriately to the central office ground.*

It is recommended, for ease of service, that each converter shelf should have a dedicated input feeder protection circuit breaker or fuse.

Refer to the previous (Installation) chapter for additional safety precautions.

### 5.2 Calculating Wire Size Requirements

Wire size is calculated by first determining the appropriate maximum voltage drop requirement. Using the formula below calculate the CMA wire size requirement. Determine the size and number of conductors required to satisfy the CMA requirement.

$CMA = (A \times LF \times K) / AVD$ , where:

CMA = Cross section of wire in circular mil area

A = Ultimate drain in amps

LF = Conductor loop feet

K = 11.1 constant factor for commercial (TW type) copper wire

AVD = Allowable voltage drop

Check again that the ampacity rating of the cable meets the requirement for the installation application. Consult local electrical codes (NEC, CEC, etc.) for guidelines. If required, increase the size of the cable to meet the code.

### 5.3 Input/Output Connections

#### **WARNING**



**Ensure that the converter feeder breaker is turned "OFF" before attempting to work on the output cable assembly. When the shelf is connected to another operating converter or battery, the output leads must be suitably taped to prevent contact with the converter shelf or each other.**

**Secure all connections to the shelf terminals of the correct polarity; e.g., +Vcable to +Vpost.**

Minimum wire sizes and recommended feeder fuse / circuit breaker sizes are given in the specifications section at the front of this manual.

DC output wire shall be UL approved XHHW or RHH/RHW (for Canadian users, RW90 Type). Control and sense wires shall be UL approved Style 1015 (for Canadian users, TEW type).

Ensure the washers are on the bolts in the same order in which they were shipped from the factory.

#### 5.3.1 Cable

Terminate cable leads with appropriate crimp lugs.

#### 5.3.2 Bus Bar

Bus bar adapters may be factory-installed, for the option selected, to easily accommodate direct connections to customers' vertical bus bars.

## 5.4 CAN Serial Ports

Two CAN Serial ports (modular jacks with offset latches) are provided for communications with Alpha' Cordex rectifiers and other CAN-enabled equipment. These are located on the right side of the shelf (as viewed from the front).

Daisy-chain (CAN OUT of one shelf to CAN IN of another) as necessary and ensure that only the last shelf is terminated. See drawing 030-900-08.

### 5.4.1 CAN Termination

A jumper (or switch depending on your configuration) allows setting of the CAN OUT to be open (to the next shelf in the system) or terminated. Termination must be enabled in final shelf on the CAN bus only. Access termination selection (inside the shelf) by removing the converter closest to the CAN ports.

## 5.5 Network Connection and Remote Communications via CXCI/CXCI+

The Cordex system can be set up, monitored and tested via Ethernet 10/100 Base-T serial data connection. The communication protocol supports a web interface. Some standard scenarios are described below:

### 5.5.1 Modem Port (not available on the CXCI+)

The Modem port is designed for CXCI connection to the Alpha Technologies' Cordex DC Modem (#018-585-20) via a front panel DB-9 connector.

Connect to the CXCI from the modem with the Alpha-supplied DB-9 cable.

#### **CAUTION**

**Connect only Alpha-supplied modem and cable; otherwise, equipment damage can result.**

### 5.5.2 Ethernet Port for Network Connection (Standard Network Cable)

The Ethernet port is designed for CXCI/CXCI+ connection to a user supplied network (TCP/IP secured by user) via a front panel RJ-45 jack.

Connect to the Cordex shelf using a standard network cable. Pinouts are shown in drawing 030-900-08.

### 5.5.3 Ethernet Port for Local Connection (Crossover Cable)

Local access (e.g., laptop computer) is also possible from the Ethernet port connection.

Connect using a standard network crossover cable.

## 5.6 Signal Wiring Connections for CXCI/CXCI+

**NOTE:** To aid the user with installation, frequent reference is made to drawings located at the rear of this manual. Custom configurations may be detailed within the Alpha power system documentation package.

For terminal block connections, the recommended wire sizes are 0.14 to 0.75mm<sup>2</sup> (#26 to #18 AWG) for the temperature range of 0 to 50 deg. C (as per UL/CSA).



**CAUTION:** to reduce risk of fire, use only 0.14mm<sup>2</sup> (#26 AWG) or larger wire.

### 5.6.1 Alarm (Relay) Outputs

Terminals provide contacts for extending various alarm or control signals. Each relay output can be wired for NO or NC operation during an alarm or control condition. See Figure 9.

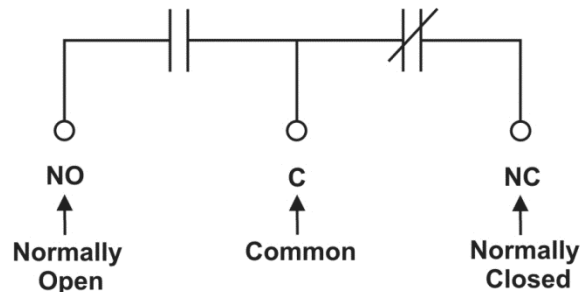


Figure 9—Showing relay connections

Relays can be programmed to energize or de-energize during an alarm condition (see CXC Software manual). When the CXCI/CXCI+ reset button is pressed or power is lost, all relays de-energize.

### 5.6.2 Digital Inputs for CXCI/CXCI+

The digital input channels (factory-installed) are used to monitor various alarm and control signals. All input channels are voltage activated and accept a bipolar (i.e. negative or positive) DC signal directly.

D1 and D2 on TB12 are available for customer connections as required.

#### 5.6.2.1 Connection Method

Typical Alpha systems use the “reset with Hot and trigger with Ground” connection. The digital input is wired in such a way that the Hot is wired directly into one of the input terminals; e.g., negative input for -48V systems. The other input terminal is wired to the Ground (common) of the system through a relay (dry contact – usually located on the equipment requiring monitoring). This method (see Figure 10) allows the digital input to receive (or not receive) a Ground signal on an alarm.

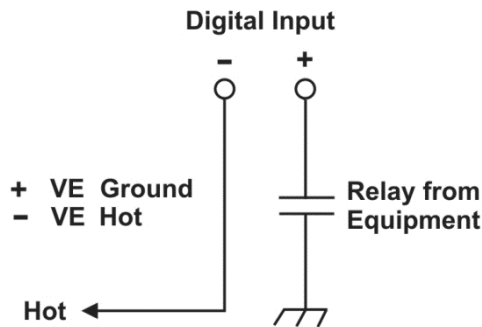


Figure 10—Showing digital input connection method

### 5.6.2.2 Programming the Digital Input

The digital input channels can be programmed for “active high” or “active low.” Active high indicates “alarm on the presence of a ground signal” and active low indicates “alarm on the removal of a ground signal.” See CXC Software manual for detailed instruction on programming.

Voltage Range (VDC)	Voltage Level (VDC) Considered As “0” (Off)	Voltage Level (VDC) Considered As “1” (On)
0—60 (system voltage setting)	0—3	9—60

**Table 2 Voltage level definitions for digital inputs**

### 5.6.3 Analog Inputs for CXCI/CXCI+

**CAUTION: Ensure the correct polarity is used for all input cable terminations.**

The analog input channels are used to monitor various types of electrical signals.

#### 5.6.3.1 Voltage

Voltage Input #1 (load voltage per CXC software) terminals (V1) on the shelf provide connections to an optional secondary voltage input.

Voltage Input #2 (battery voltage per CXC software) is wired internally (V2) to the output voltage of the shelf. This is used as the reference for system alarming (such as high voltage) and control (such as LVD).

#### 5.6.3.2 Temperature Sensor

Temperature Probe input channels (T1 and T2) provide connections for up to two temperature sensors. A voltage is supplied to these terminals for sensor measurements.

#### 5.6.3.3 Current

Current Input #1 (load current per CXC software) is wired externally to a system current shunt (100A/50mV) in the negative lead.

## 6 System Startup

After completing the shelf wiring and installation, perform the following startup and test procedure to ensure proper operation:

### 6.1 Check System Connections

- Ensure power is off, battery is disconnected, and all modules are removed from the shelves.
- Triple check the polarity of all connections.

### 6.2 Power the Converter Shelf

1. Provide power to the converter shelf either from a rectifier shelf or batteries.

**NOTE:** *The CXCI/CXCI+ controller is powered from the primary +24V bus.*

2. After a brief validation cycle, the CXCI/CXCI+ LEDs indicate the status of system alarms.
3. Login to the controller as follows:
  - a. Set the laptop IP Network settings (**Start > Control Panel**)
    - IP address: 10.10.10.202
    - Subnet mask:255.255.255.0
  - b. Turn off Pop-up Blocker.
  - c. Enter 10.10.10.201 in the web address bar of the laptop.
  - d. Login to the CXC controller:
    - Username: your company name and your initials
    - Password: 1234
    - Language selection: English
4. Use the CXC controller to test the functionality of various module alarms and controls.

### 6.3 Converter Operation and Programming via the CXC

The existing CXC Controller Signals category now includes signals for Converter Load Voltage and Converter Load Current; by default, Average Conv. Output Voltage and Total Conv. Output Current are used respectively.

#### 6.3.1 Load Current in a Rectifier/Converter System

For proper operation of Charge Current Control and Power Save, the system load current must include the current drawn from the rectifiers used to power the converters. Depending on the location of the current shunt in the system, it may be necessary to modify the Load Current equation to add the Total Converter Input Current.

To view the load current of the system load, without the influence of the Converter Input Current, a custom signal can be created; for example, if Load A powers some equipment and Load B is the current drawn by the converters, then the equation for Load A would be: Total Rectifier Output Current - Total Converter Input Current.

#### 6.3.2 Recommendation for Converter Redundancy

During firmware upgrade (programming) of the converter, the converter being programmed will be turned off and not deliver any power. This is largely due to the way in which the converter begins operation after programming.

The power-up sequence for a converter is to start with 0V and 0A for a Start Delay of one through ten seconds. After this period has expired, the converter will ramp up the Output Voltage and Current Limit values to the appropriate settings in about one second. Furthermore, since the converter will be off for at least this amount of time, the present implementation turns off the converter before the programming. The programming time is added to the Start Delay to provide the total amount of time for which the converter will be off or out-of-service.

Therefore, with one redundant converter in a system, the load will still receive power from the other converters while one of them is being programmed.

## 6.4 CXC Reset

### 6.4.1 Soft Reset

The reset button located on the front panel of the CXC is for restarting the microprocessor. When pressed momentarily, the unit beeps twice then resets. The front-panel LED's will illuminate temporarily, but will extinguish after the system has finished its 15-second self-test.

**CAUTION: During rest, the controller may need to run a defragmentation cycle. Cycling of the LEDs in the front panel indicate that defragmentation is in progress. All full defragmentation can take up to 20 minutes to perform. DO NOT POWER DOWN the CXC during this time.**

### 6.4.2 CXCI/CXCI+ IP Address Reset

To reset the IP address, press and hold the front panel reset button for three seconds. The CXCI/CXCI+ unit will beep three times, IP will be reset (to 10.10.10.201) and DHCP will be disabled. The settings will be saved and the unit will then reset.

This will allow local access; e.g., with a laptop and a standard network crossover cable. See current version software manual for details.

### 6.4.3 CXCI/CXCI+ Hard Reset

There is a hard reset button located on right on the side of the CXCI (Figure 2) and on the front of the CXCI+ (Figure 3). This may be used to restart the microprocessor in the event that the front panel (soft) reset button fails to operate as described above.

**CAUTION: Use of hard reset may cause loss of data.**

To access the hard reset button, remove the module adjacent to the CXCI/CXCI+.

### 6.4.4 Time Settings

The CXCI/CXCI+, upon startup\*, will set the time based on the following:

- Attempt to synchronize with the NTP server (see [www.NTP.org](http://www.NTP.org)).
- Retrieve the last time stamp from the Event Log.
- Retrieve the last time stamp from the Statistics Log.
- Set the time to 2005-01-01 midnight.

\* Whenever the unit is reset or power is completely removed from the CXCI/CXCI+.

## 7 Maintenance

Although very little maintenance is required with Alpha systems, routine checks and adjustments are recommended to ensure optimum system performance. Qualified service personnel should do repairs.

**NOTE:** Consult factory for replacement parts.

The following table lists a few maintenance procedures for this system. These procedures should be performed at least once a year.



**WARNING: HIGH VOLTAGE AND SHOCK HAZARD.**

**Use extreme care when working inside the shelf while the system is energized. Do not make contact with live components or parts.**

**Circuit cards, including RAM chips, can be damaged by static electricity. Always wear a grounded wrist strap when handling or installing circuit cards.**

**Ensure redundant modules or batteries are used to eliminate the threat of service interruptions while performing maintenance on the system's alarms and control settings.**

Procedure	Date Completed
Clean ventilation openings	
Inspect all system connections (re-torque as necessary)	
Verify alarm/control settings	
Verify alarm relay operation	

**Table 3 Sample maintenance log**

### 7.1 Fan Replacement

**CAUTION: Use fan assembly with correct connector as supplied by Alpha.**

1. Shut off the unit and unlatch (rotate) the front fastener that secures the module to the shelf.
2. Slide the module 10cm (4") out of the shelf and wait two minutes for module capacitors to discharge.
3. Access the fan by removing the screws (top and side) that secure the front panel to the module chassis.
4. Disconnect the fan power lead wires from the module.
5. Note the direction of air flow (into the module front) and remove the fan from the front panel.
6. Install the replacement fan with the correct airflow direction following the preceding steps in reverse order.

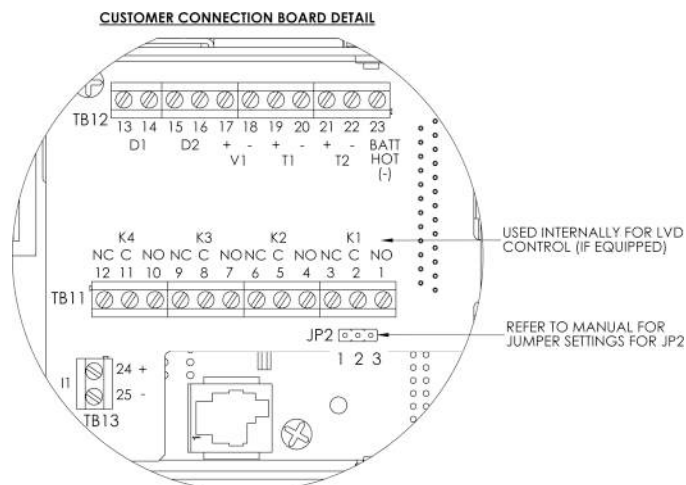
**NOTE:** Use care with fan wire routing so that the lead wires do not become pinched when the front panel is reattached.

## 7.2 CXCI/CXCI+ Replacement Procedure

### 7.2.1.1 Replacing a CXCI controller

1. Write down the CXC communication information: dynamic or static IP, IP address, and gateway.
2. Connect a laptop to CXC per software manual; standard network crossover cable to Ethernet port.
3. Save the CXC configuration file (see software manual **Logs and Files > Manage Configuration File > Save Full Site Configuration**).
4. Save the CXC text file if necessary: **Logs and Files > Manage Editable Text Files > Save Dynamic Text File**.
5. If applicable, bypass the system LVD:
  - Locate JP2 on the back of CXCI system shelf (Figure 11)
  - If the LVD is controlled on NC contacts (factory default for LVD option), then JP2 pins 1 and 2 must be shorted together to maintain LVD operation.
  - If the LVD is controlled on NO contacts, then JP2 pins 2 and 3 must be shorted together.

**NOTE:** *bypassing the LVD generates an alarm.*



**Figure 11–Location of LVD bypass jumper**

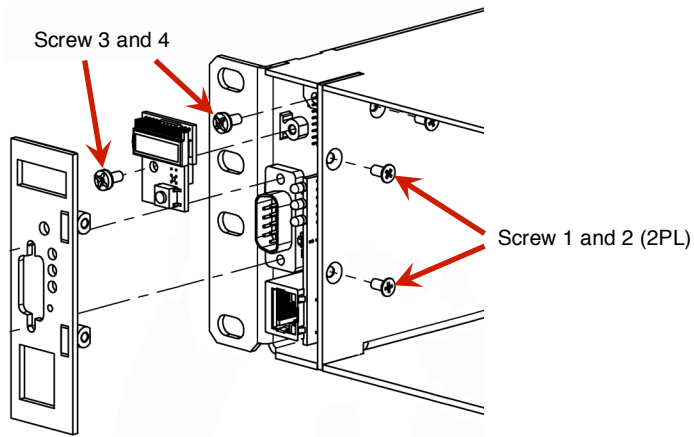
6. Disconnect the DB signal connector from the CXCI at the rear of the shelf.
7. Ensure converter is in the right-most position.
8. Remove converter in the left-most position in order to access the side of the CXCI where the mounting screws are located.

**NOTE:** It is recommended that the first module be inserted into the front leftmost position using the side of the shelf (or the optional shelf-mounted controller) as a guide. Subsequent modules may be inserted using the previous module as a guide.

**Original CXCI design is shown below. For the latest CXCI/CXCI+ design, regarding illustrations and procedure, refer to the Installation chapter.**

9. Remove four (4) mounting screws from the CXCI as shown below. The first two screws will release the front panel from the controller circuit board to expose the third screw that releases the LCD circuit board. Carefully remove the LCD board to expose the fourth and final screw to release the remains of the CXCI.





**Figure 12—Showing CXCI (original design) replacement detail**

10. Replace CXCI following steps 7 and 8 in reverse order. CAUTION - Do not push on the LCD.

**To replace original design with the latest CXCI/CXCI+ design, refer to the Installation chapter (remove the pem, etc.), and then continue with the next steps regarding the CXC/CXCI+ configuration.**

11. Replace the DB connector on the back of the CXCI/CXCI+.
12. Log on to the CXC and go to **Logs and Files > Manage Configuration File > Upload Site Configuration** and select the saved \*.cfg file. After the upload do a **Submit Changes**. Make sure the site information is checked to save it, and click **Accept**.
13. Go to **Logs and Files > Manage Editable Text Files > Upload Dynamic Text File** and select the saved \*.tfg file. You do not need to submit changes; it is already saved.
14. Use a meter to verify the bus voltage and current shunt. Recalibrate as required due to differences in the new CXCI/CXCI+.
15. Replace converters and remove LVD bypass.

### 7.2.1.2 Replacing a CXCI+ Controller

1. Write down the CXC communication information: dynamic or static IP, IP address, and gateway.
2. Connect a laptop to CXC per software manual; standard network crossover cable to Ethernet port.
3. Save the CXC configuration file (see software manual **Logs and Files > Manage Configuration File > Save Full Site Configuration**).
4. Save the CXC text file if necessary: **Logs and Files > Manage Editable Text Files > Save Dynamic Text File**.
5. If applicable, bypass the system LVD:
  - Locate JP2 on the back of CXCI/CXCI+ system shelf (Figure 11)
  - If the LVD is controlled on NC contacts (factory default for LVD option), then JP2 pins 1 and 2 must be shorted together to maintain LVD operation.
  - If the LVD is controlled on NO contacts, then JP2 pins 2 and 3 must be shorted together.

**NOTE:** *bypassing the LVD generates an alarm.*

6. Disconnect the DB signal connector from the CXCI/CXCI+ at the rear of the shelf.
7. Ensure a converter is in the right-most position. Remove the converter in the left-most position in order to access the side of the CXCI/CXCI+ where the mounting screws are located.
8. Place the CXCI+ controller module on the shelf bottom and slide into the rear connector at the back of the slot.



**Figure 13—Cordex CXCI+ controller module**

9. Replace the DB connector on the back of the CXCI/CXCI+.
10. Log on to the CXC and go to **Logs and Files > Manage Configuration File > Upload Site Configuration** and select the saved \*.cfg file. After the upload do a Submit Changes. Make sure the site information is checked to save it, and click Accept.
11. Go to **Logs and Files > Manage Editable Text Files > Upload Dynamic Text File** and select the saved \*.tfg file. You do not need to submit changes; it is already saved.
12. Use a meter to verify the bus voltage and current shunt. Recalibrate as required due to differences in the new CXCI/CXCI+.
13. Replace converters and remove LVD bypass.

### 7.2.1.3 Replacing a CXCI Controller with a CXCI+ Controller

1. Write down the CXC communication information: dynamic or static IP, IP address, and gateway.
2. Connect a laptop to CXC per software manual; standard network crossover cable to Ethernet port.
3. Save the CXC configuration file (see software manual **Logs and Files > Manage Configuration File > Save Full Site Configuration**).
4. Save the CXC text file if necessary: **Logs and Files > Manage Editable Text Files > Save Dynamic Text File**.
5. If applicable, bypass the system LVD:
  - Locate JP2 on the back of CXCI/CXCI+ system shelf (Figure 11)
  - If the LVD is controlled on NC contacts (factory default for LVD option), then JP2 pins 1 and 2 must be shorted together to maintain LVD operation.
  - If the LVD is controlled on NO contacts, then JP2 pins 2 and 3 must be shorted together.

**NOTE:** *bypassing the LVD generates an alarm.*

6. Disconnect the DB signal connector from the CXCI at the rear of the shelf.
7. Ensure a converter is in the right-most position. Remove the converter in the left-most position in order to access the side of the CXCI/CXCI+ where the mounting screws are located.
8. Remove four (4) mounting screws from the CXCI (Figure 12). The first two screws will release the front panel from the controller circuit board to expose the third screw that releases the LCD circuit board. Carefully remove the LCD board to expose the fourth and final screw to release the remains of the CXCI.
9. Place the CXCI+ controller module on the shelf bottom (Figure 13) and slide into the rear connector at the back of the slot.
10. Replace the DB connector on the back of the CXCI/CXCI+.
11. Log on to the CXC and go to **Logs and Files > Manage Configuration File > Upload Site Configuration** and select the saved \*.cfg file. After the upload do a **Submit Changes**. Make sure the site information is checked to save it, and click **Accept**.
12. Go to **Logs and Files > Manage Editable Text Files > Upload Dynamic Text File** and select the saved \*.tfg file. You do not need to submit changes; it is already saved.
13. Use a meter to verify the bus voltage and current shunt. Recalibrate as required due to differences in the new CXCI/CXCI+.
14. Replace converters and remove LVD bypass.

## 8 Warranty

For full warranty information, please contact us:

**Tel: +49 9122 79889 0**

**Mail: [info@alpha-outback-energy.com](mailto:info@alpha-outback-energy.com)**

### 8.1 Warranty

Alpha and Outback Energy GmbH . warrants all equipment manufactured by it to be free from defects in parts and labor, for a period of two years from the date of shipment from the factory. The warranty provides for repairing, replacing or issuing credit (at AOE's discretion) for any equipment manufactured by it and returned by the customer to the factory or other authorized location during the warranty period. There are limitations to this warranty coverage. The warranty does not provide to the customer or other parties any remedies other than the above. It does not provide coverage for any loss of profits, loss of use, costs for removal or installation of defective equipment, damages or consequential damages based upon equipment failure during or after the warranty period. No other obligations are expressed or implied. Warranty also does not cover damage or equipment failure due to cause(s) external to the unit including, but not limited to, environmental conditions, water damage, power surges or any other external influence.

The customer is responsible for all shipping and handling charges. Where products are covered under warranty AOE will pay the cost of shipping the repaired or replacement unit back to the customer.

## 9 Acronyms and Definitions

AC	Alternating current
ANSI	American National Standards Institute
AWG	American wire gauge
CAN	Controller area network
CEC	Canadian Electrical Code
CMA	Circular mil area
CSA	Canadian Standards Association
CX	Cordex™ series; e.g., CXC for <u>C</u> ordex <u>S</u> ystem <u>C</u> ontroller
DC	Direct current
DHCP	Dynamic host configuration protocol
EMC	Electromagnetic compatibility
EMI	Electromagnetic interference
ESD	<u>E</u> lectrostatic <u>d</u> ischarge
FCC	Federal Communications Commission (for the USA)
IP	Internet protocol
LED	Light emitting diode
LVD	Low voltage disconnect
NC	Normally closed
NEC	National Electrical Code (for the USA)
NO	Normally open
OSHA	Occupational Safety & Health Administration
OVP	Over voltage protection
RAM	Random access memory
RU	Rack unit (1.75")
TCP/IP	Transmission control protocol / internet protocol
UL	Underwriters Laboratories

# Specifications for Alpha Technologies' Cordex DC/DC Converter, 24V to 48V

## Module Input

Voltage:	+21 to +30Vdc
Efficiency:	>88% @ 50 to 100% load
Electrical Noise:	<32dBnC (voice band) <10mVRMS 10kHz to 10MHz (wideband) <150mVp-p 10kHz to 100MHz
Current:	≤94A @ +24Vdc input, 108A maximum

## Module Output

Voltage:	-48 to -54Vdc
Current:	0 to 37A
Power:	2kW maximum @ -54Vdc
Static Regulation:	±0.1% line; -1.0% ±0.1% load
Dynamic Regulation:	<1% deviation for 50 to 100% load step; settling to 0.1% in <2ms
Time Stability:	0.1% per year
Temperature Stability:	<100ppm/°C
Electrical Noise:	<38dBnC (voice band) <10mVRMS 10kHz to 10MHz (wideband) <150mVp-p 10kHz to 100MHz
Acoustic Noise:	<60dBa at 1m (3 ft)

## Module Indicators

DC Input OK:	LED – green
Module ON:	LED – green
Alarm (Module Fail):	LED – red (major); red flashing (minor)

## Mechanical, Module

Size:	84mm H x 100mm W x 235mm D overall, includes handle (3.3" H x 3.94" W x 9.25" D)
Weight:	2.8 kg (6.2 lb.)
Connections:	High current terminals, hot-swappable
Cooling:	Forced air, front-to-back
I/O Protection:	Internal fusing

### Mechanical, 23" Shelf

Size:	88.4mm H x 541mm W x 332mm D overall, includes handle and rear terminal cover but does not include mounting brackets (3.48" H x 21.3" W x 13.1" D)
Mounting:	23" flush or 6" offset
Weight:	10.4 kg (23 lb.)

### Mechanical, 19" Shelf

Size:	88.4mm H x 438mm W x 332mm D overall, includes handle and rear terminal cover but does not include mounting brackets (3.48" H x 17.2" W x 13.1" D)
Mounting:	Flush (only for 19" rack), 6" offset (19" or 23" rack)
Weight:	8.6 kg (18.9 lb.)

### Environmental

Temperature:	-40 to +65°C (-40 to +149°F) standard operating -40 to +70°C (-40 to +158°F) storage
Humidity:	0 to 95% non-condensing
Elevation:	-500 to +2800 m (-1640 to 9186 ft)

### Standards Compliance

This product is designed to meet or exceed the following:

FCC 47 CFR part 15:	Class A radiated and conducted EMI
EN 55022 (CISPR 22):	Class A radiated and conducted EMI
ENV 50204:	Radiated electromagnetic immunity (digital radio and telephones)
EN 61000-4-2:	ESD Immunity
EN 61000-4-3:	Radiated Electromagnetic Immunity
EN 61000-4-4:	Electrical Fast Transients Burst Immunity
EN 61000-4-6:	Conducted Electromagnetic Immunity
CE:	EN 60950-1
CAN/CSA (NRTL/C):	C22.2 No. 60950-1-03
ANSI/UL (NTRL):	60950-1
Bellcore GR-63-CORE:	Vibration and Shock
Bellcore GR-1089-CORE:	Electromagnetic Compatibility and Electrical Safety

### Shelf Connections (rear access except where noted)

Input, +24V, Feed A:	3/8" holes, 1" spacing (1 set)
Input, +24V, Feed B: (030-839-20 only)	3/8" holes, 1" spacing (1 set)
Shelf Common Return:	3/8" holes, 1" spacing (1 set)
Output, -48V:	3/8" holes, 1" spacing (1 set)

**NOTE:** Back-to-back lug installation is possible for DC input and output connections. Refer to -08 drawings at the rear of the manual.

Signal Wiring:	0.14 to 1.50mm <sup>2</sup> (#26 to #16 AWG) [via DB-25 connector if CXCI equipped] (see drawing at the rear of this manual)
Communications:	CAN (bus) RJ-12 offset, OUT and IN; side access

### Recommended Disconnect Device and Wire Sizing

Input Wire Size (minimum):

#### For Input LVD\* of 22Vdc or Higher

\* set via Cordex controller

23" Bulk Feed:	700A breaker or fuse 2x 350MCM ≥ 90°C rated @ 60°C
19" Bulk Feed:	500A breaker 2x 250MCM ≥ 90°C rated @ 60°C
19" Dual Feed:	250A breaker 1x 250MCM ≥ 90°C rated @ 60°C or 2x #1AWG

#### For Input LVD\* 21 to 22Vdc

\* set via Cordex controller

23" Bulk Feed:	700A breaker or fuse 2x 350MCM ≥ 90°C rated @ 60°C
19" Bulk Feed:	600A breaker 2x 350MCM ≥ 90°C rated @ 60°C
19" Dual Feed:	300A breaker 1x 350MCM ≥ 90°C rated @ 60°C or 2x 1/0AWG

Output Wire Size (minimum):

23" Shelf:	3/0AWG ≥ 90°C rated
19" Shelf:	1/0AWG ≥ 90°C rated

*The above information is valid at the time of publication. Consult factory for up-to-date ordering information. Specifications are subject to change without notice.*



# Specifications for Alpha CXCI/CXCI+ Cordex Controller Integrated Model

## Basic Unit, CXCI/CXCI+

CXCI Input Voltage:	17 to 65Vdc within rated limits [9 to 65Vdc for shelf systems with 12V rectifiers (List 3)]
CXCI+ Input Voltage:	10 to 65Vdc within rated limits
Current:	<100mA @ 48Vdc <200mA @ 24Vdc
MTBF:	CXCI: 472,000 hours @ 25°C (77°F) CXCI+: 1,500,000 hrs @30°C ambient; test model Telcordia SR-332, Issue 2
EMC:	

## Radiated and Conducted Emissions

### CXCI:

North America Regions:  
CFR 47, Part 15 Subpart J, Class A

### CXCI+:

North America Regions:

- CFR 47, Part 15 Subpart B, Class B
- ICES-003 Issue 2, Rev 1, Class

European Regions

- EN 55022 Class B
- EN 300 386-2
- EN61000-3-2; Harmonics
- EN61000-3-3; Flicker

## Immunity

### CXCI+:

- EN 300 386-2
- EN61000-4-2:2005, ESD ± 8 kV Air, ± 6 kV Contact
- EN61000-4-3:2005, RF Immunity 10 V/m
- EN61000-4-4:2005, EFT, 1kV/0.5kV
- EN61000-4-5:2005, Surge; 2 kV line to line, 1 kV line to earth
- EN61000-4-6:2005, Conducted Susceptibility, 10 Vrms
- EN61000-4-11: Voltage Dips and Interruptions

In accordance with FCC requirements, we provide the following statement as specified in the FCC guidelines for conformance to Part 15, Class B:

**Warning:** *The CXCI+ has been tested and found to comply with the limits for a Class B digital device, pursuant to part 15 of the FCC Rules. These limits are designed to provide reasonable protection against harmful interference in a residential installation. This equipment generates, uses, and can radiate radio frequency energy and, if not installed and used in accordance with the instructions, may cause harmful interference to radio communications. However, there is no guarantee that interference will not occur in a particular installation. If this equipment does cause harmful interference to radio or television reception, which can be determined by turning the equipment off and on, the user is encouraged to try to correct the interference by one or more of the following measures:*

- Reorient or relocate the receiving antenna.
- Increase the separation between the equipment and receiver.
- Connect the equipment into an outlet on a circuit different from that to which the receiver is connected.
- Consult the dealer or an experienced radio/TV technician for help.

## Specifications for Alpha CXCI/CXCI+ Cordex Controller Integrated Model Continued

In Accordance with FCC requirements, we provide the following statement as specified in the FCC guidelines for conformance to Part 15, Class A:

**NOTE:** *The CXCI has been tested and found to comply with the limits for a Class A digital device, pursuant to part 15 of the FCC Rules. These limits are designed to provide reasonable protection against harmful interference when the equipment is operated in a commercial installation. This equipment generates, uses, and can radiate radio frequency energy and, if not installed and used in accordance with the instruction manual, may cause harmful interference to radio communications. Operation of this equipment in a residential area is likely to cause harmful interference in which case the user will be required to correct the interference at his own expense.*

Any changes or modifications to this equipment not expressly described in this manual could void the FCC compliance.

### Environmental

Temperature:	-40 to 65°C standard @ 3000m derate to 55°C @ 4000m (-40 to 149°F derate to 131°F @ 13124ft)
Humidity:	0 to 95% non-condensing
Elevation:	-500 to +4000m (-1640 to 13124 ft)

### Hardware Specifications, CXCI/CXCI+

CPU:	Coldfire
Display:	4 digit LCD
Front Panel Controls:	Display pushbutton toggle switch for voltage (V) or current (A) CXCI/CXCI+ reset switch (soft reset button; hold for 3 seconds to reset IP)
LEDs:	System OK (Green) Power System Minor Alarm (Yellow) Power System Major Alarm / Controller Fail (Red)
Audio:	Built-in speaker for alarm and popup message tones
Dimensions:	88mm H x 26mm W x 280mm D (3.5" H x 1" W x 11" D)
Weight:	0.34 kg (0.75 lb.)
Mounting:	Integrated on Cordex 2RU series 19" and 23" shelves
Relay Outputs:	Four (4) Form C, 60Vdc 1A maximum
Digital Inputs:	Two (2), 0 to 60Vdc
Analog Inputs:	One (1) DC voltage, 0 to 60Vdc One (1) DC current, $\pm 50\text{mV}$ Two (2) temperature, self-powered Alpha sensor (max 12Vdc)
CXCI Communication Ports:	Ethernet RJ-45, Alpha Modem DB-9, CAN [see shelf specifications]
CXCI+ Communication Ports:	Ethernet RJ-45, CAN [see shelf specifications]

## Software Specifications, CXCI/CXCI+

CXCI	Software version: All
CXCI+	Software version: 2.10 minimum

## Recommended Signal Wire Sizes (as per UL/CSA)

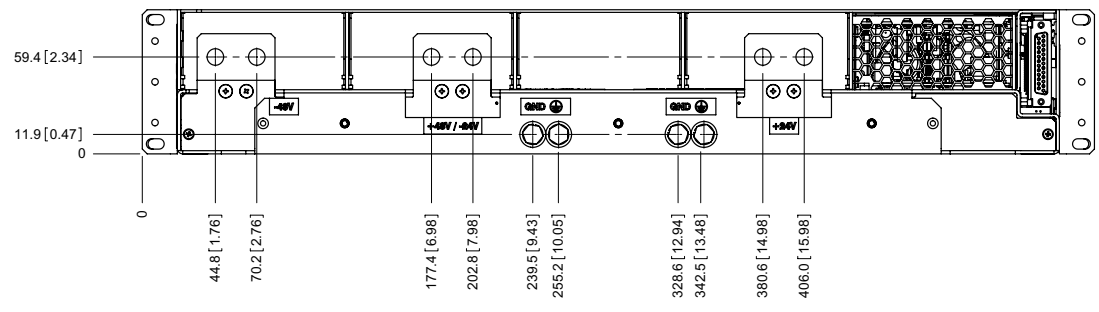
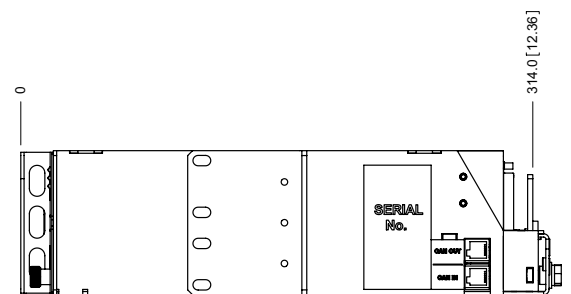
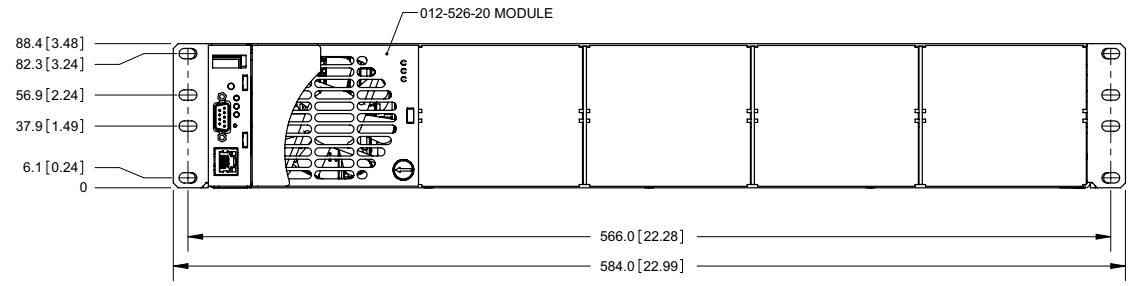
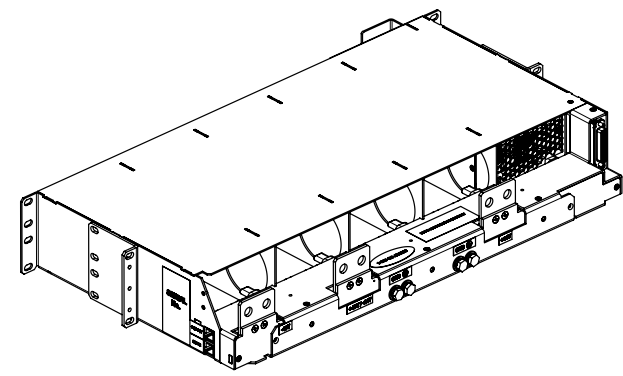
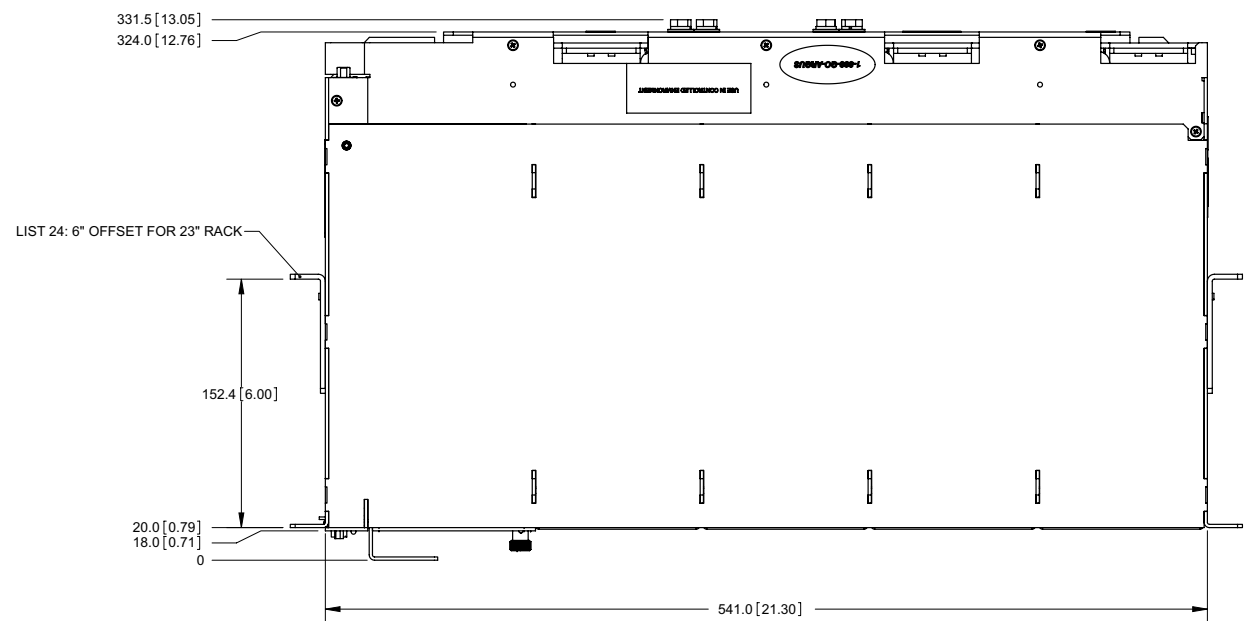
Wire Size Range: 0.14 to 1.50mm<sup>2</sup>  
(#26 to #16 AWG)

Temperature Range: 0 to 50°C  
(32 to 122°F)

**CAUTION – TO REDUCE RISK OF FIRE, USE ONLY 0.14mm<sup>2</sup> (#26 AWG) OR LARGER WIRE.**

*The above information is valid at the time of publication. Consult factory for up-to-date ordering information. Specifications are subject to change without notice.*

REVISIONS				
LTR	DESCRIPTION	DWN	DATE	APPD
B	RE-DESIGNED	SY	08/03	GA



## ARGUS®

THESE DESIGNS AND SPECIFICATIONS ARE THE PROPERTY OF ARGUS TECHNOLOGIES AND SHALL NOT BE COPIED OR USED FOR MANUFACTURING WITHOUT ITS WRITTEN CONSENT.

UNITS: mm [in]

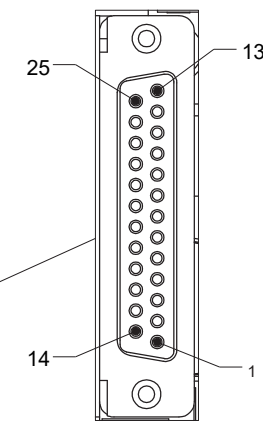
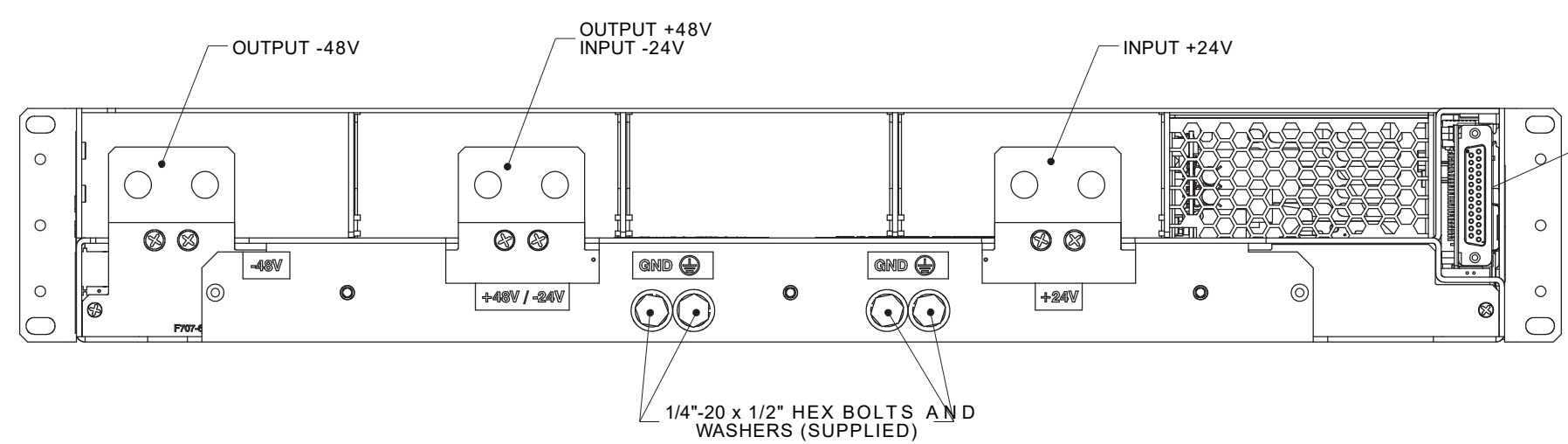
X [X.X]	±1	[±0.040]
XX [X.XX]	±0.5	[±0.020]
XXX [X.XXX]	±0.05	[±0.002]
ANGULAR:	±0.5°	

SCALE: NTS

TITLE: OUTLINE DRAWING SHELF		SHEET 1 OF 1	
23" 5 MDL CXDF 2 KW			
DESIGN	RP	2007/12	ISSUE DATE
DRAWN	JU	2007/12	DATE
CHECKED	GA	2007/12	SIZE TYPE DWG NO.
APPROVED	GS	2007/12	B D2 030-900-06 REV B

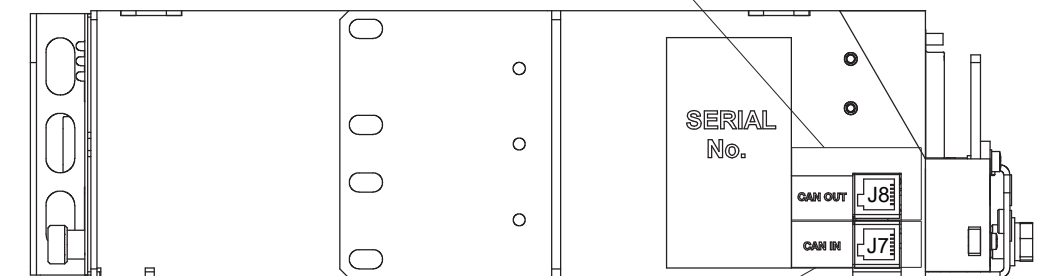
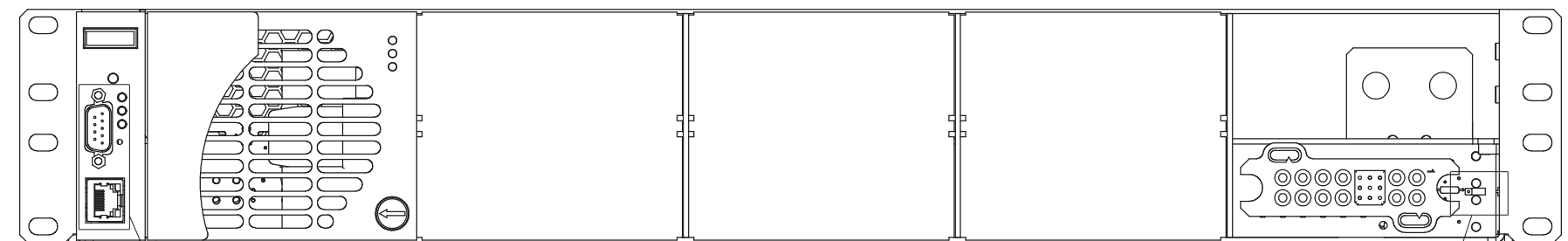
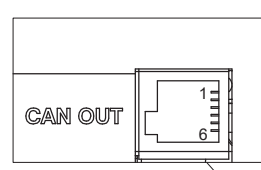
© 2007 ARGUS TECHNOLOGIES

REVISIONS					
LTR	DESCRIPTION	DWN	DATE	CHKD	APPD
B	REDESIGNED	SY	08/03		GA
C	CORRECTED TABLES	SDW			
D	ADDED CXCI+	FC	13/12		

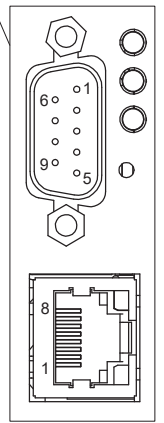


PIN	FUNCTION
1	K1-COM
2	K1-NC
3	K2-COM
4	K3-NC
5	K3-NO
6	K4-COM
7	D1-1
8	D1-2
9	V1+
10	T1+
11	T2+
12	I1+
13	BATT HOT
14	K1-NO
15	K2-NC
16	K2-NO
17	K3-COM
18	K4-NO
19	K4-NC
20	D1-2
21	D2-2
22	V1-
23	T1-
24	T2-
25	I1-

CAN OUT RJ12 OFFSET (J8)	
PIN	FUNCTION
1	CANCOM
2	CAN
3	NOT CONNECTED
4	CAN
5	NOT CONNECTED
6	NOT CONNECTED

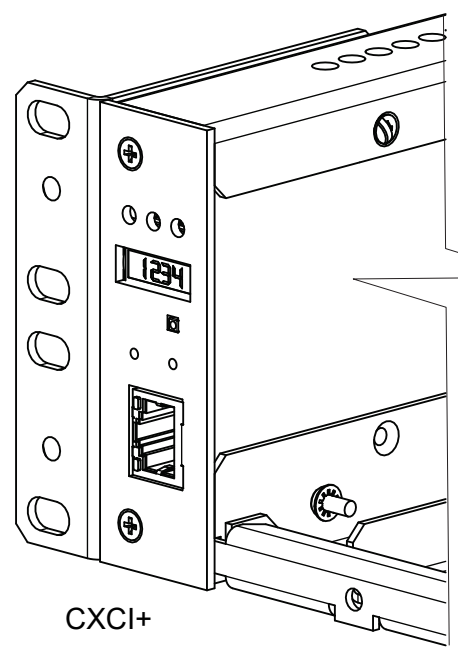


CXCI



DB9 (FOR ARGUS DC MODEM USE ONLY)	
PIN	FUNCTION
1	DCD
2	RX
3	TX
4	DTR
5	COM
6	DSR
7	RTS
8	RTS
9	RI

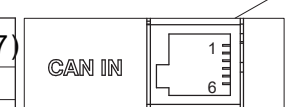
ETHERNET RJ45	
PIN	FUNCTION
1	TX+
2	TX-
3	RX+
4	NOT CONNECTED
5	NOT CONNECTED
6	RX-
7	NOT CONNECTED
8	NOT CONNECTED



TERMINATED  OPEN

CAN TERMINATION JUMPER

CAN IN RJ12 OFFSET (J7)	
PIN	FUNCTION
1	CANCOM
2	CAN H
3	NOT CONNECTED
4	CAN L
5	NOT CONNECTED
6	NOT CONNECTED



ALPHA TECHNOLOGIES™

THESE DESIGNS AND SPECIFICATIONS ARE CONFIDENTIAL, REMAIN THE PROPERTY OF ARGUS TECHNOLOGIES LTD., AND SHALL NOT BE COPIED OR USED WITHOUT ITS WRITTEN CONSENT.

UNITS: mm [in]  
X [X.X] ±1 [±0.040]  
X.X [X.XX] ±0.5 [±0.020]  
X.XX [X.XXX] ±0.05 [±0.002]  
ANGULAR: ±0.5°

SCALE: NTS

TITLE: CUSTOMER CONNECTION SHELF 23",5MDL,CXDF 2kW

DESIGN	RP	DATE
2007/12		2007/12
2007/12	JU	2007/12
2007/12	GA	2007/12
2007/12	GS	2007/12

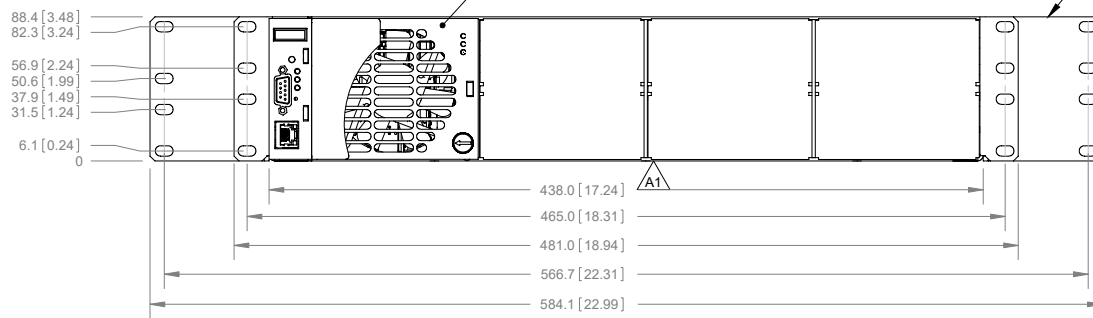
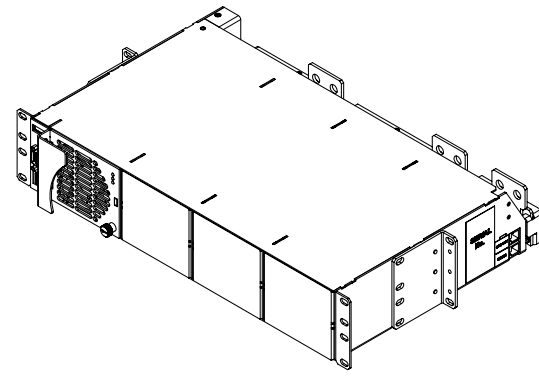
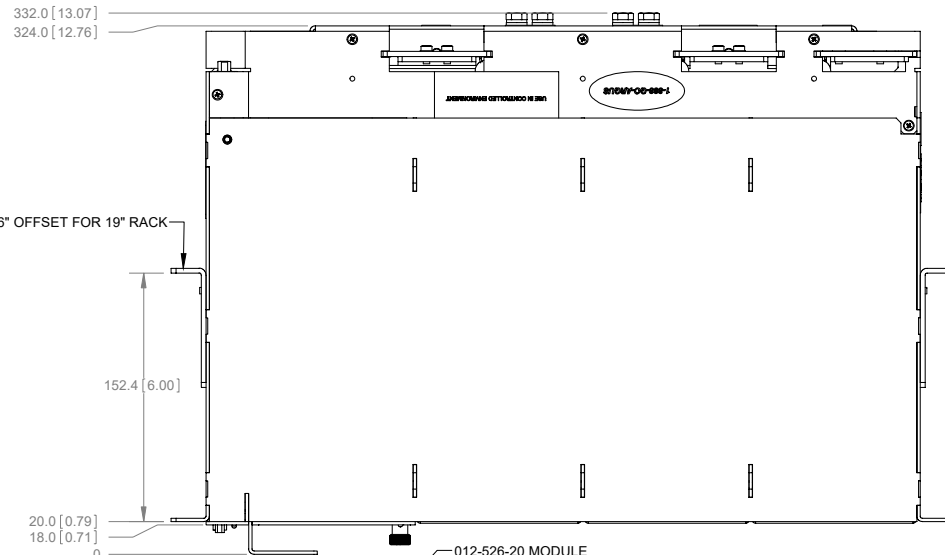
ISSUE DATE	SIZE	TYPE	DWG NO.	REV
	B	D2	030-900-08	D

SHEET 1 OF 1

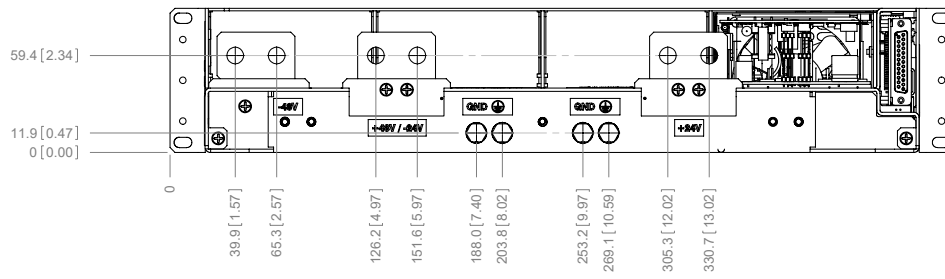
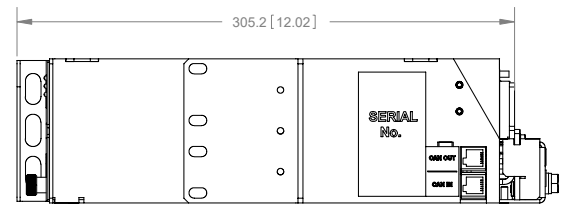
© 2013 ALPHA TECHNOLOGIES

CXCI+

REVISIONS				
LTR	DESCRIPTION	DWN	DATE	APPD
A1	DIM ADDED		08/06	



List 24 6" OFFSET FOR 23" RACK



ITEM  
QTY

# ARGUS®

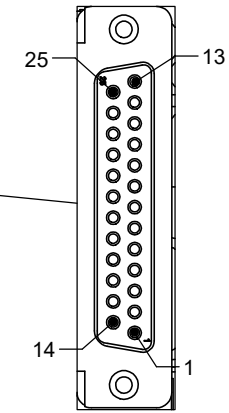
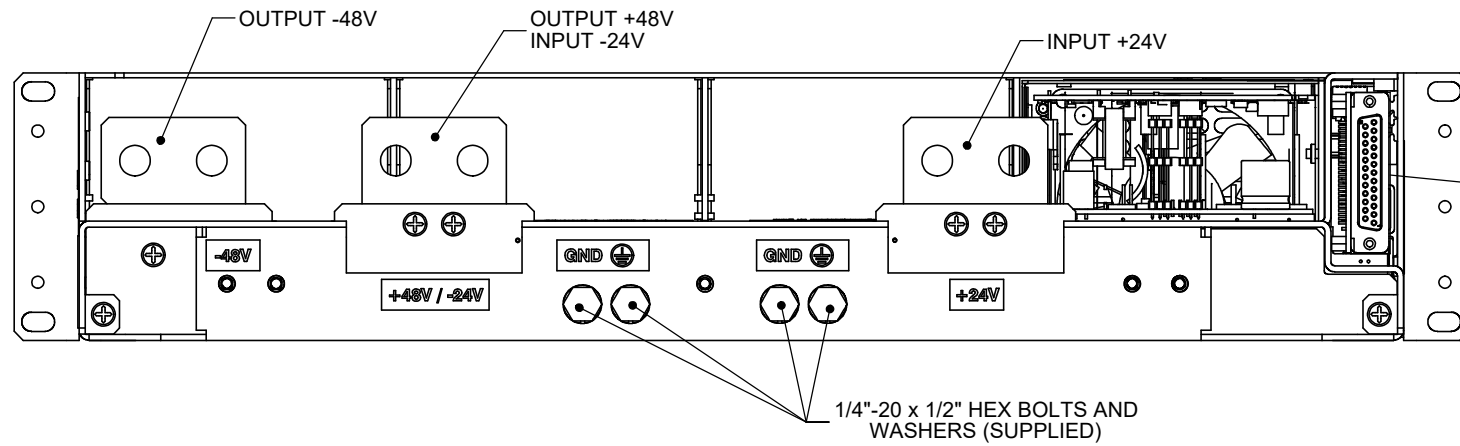
THESE DIMENSIONS AND SPECIFICATIONS ARE THE PROPERTY OF ARGUS TECHNOLOGIES AND SHALL NOT BE COPIED OR USED FOR MANUFACTURING WITHOUT ITS WRITTEN CONSENT.

UNITS: mm [in]  
 X [X.X] ±1 [±0.040]  
 X.X [X.XX] ±0.5 [±0.020]  
 X.XX [X.XXX] ±0.05 [±0.002]  
 ANGULAR: ±0.5°

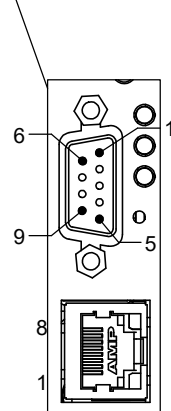
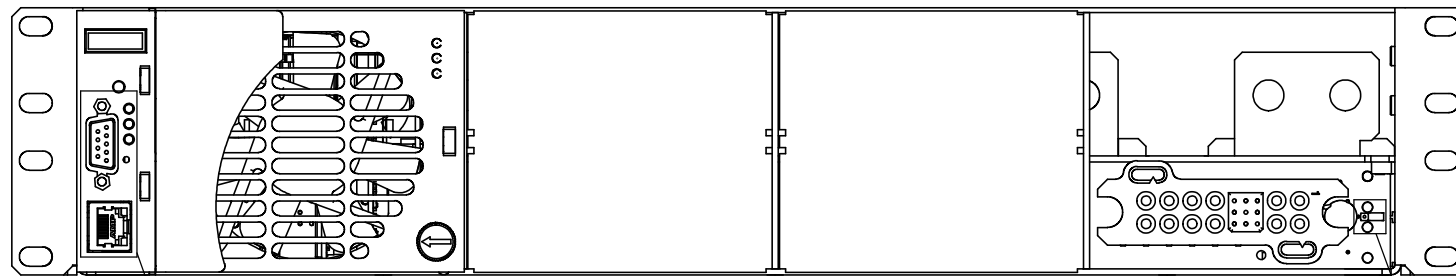
SCALE: NTS

NAME	DATE	TITLE
DESIGN	W.H 2008/06	TITLE: OUTLINE DRAWING SHELF 19" 4 MDL CXDF 2 kW
DRAWN	W.H 2008/06	ISSUE DATE SHEET 1 OF 1
CHECKED	2008/06	SIZE TYPE DWG NO. REV B D2 030-905-06 A1
APPROVED	2008/06	© 2007 ARGUS TECHNOLOGIES

REVISIONS				
LTR	DESCRIPTION	DWN	DATE	APPD
B	ADD CXCI+	FC	2013/12	



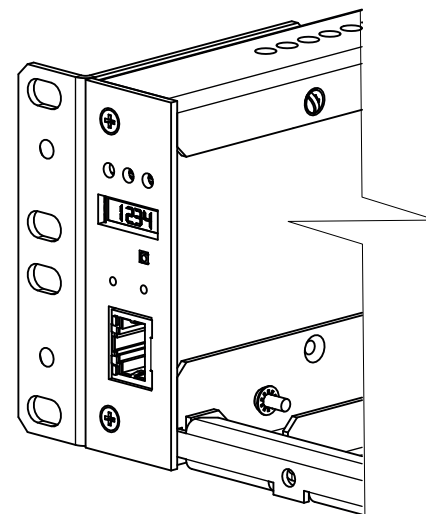
CXCI/CXCI+ DB-25	
PIN	FUNCTION
1	K1-COM
2	K1-NC
3	K2-COM
4	K3-NC
5	K3-NO
6	K4-COM
7	D1-1
8	D2-1
9	V1+
10	T1+
11	T2+
12	I1+
13	BATT HOT
14	K1-NO
15	K2-NC
16	K2-NO
17	K3-COM
18	K4-NO
19	K4-NC
20	D1-2
21	D2-2
22	V1-
23	T1-
24	T2-
25	I1-



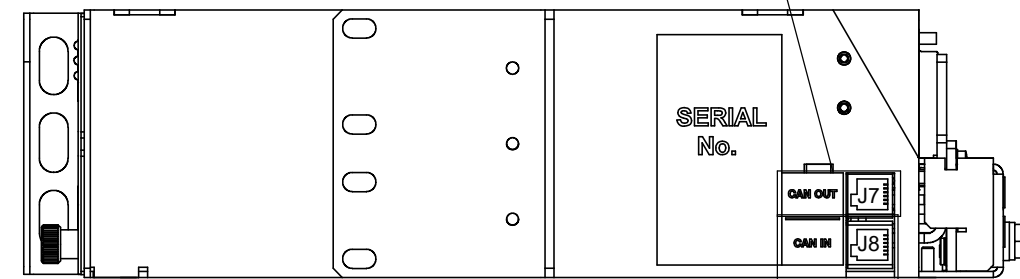
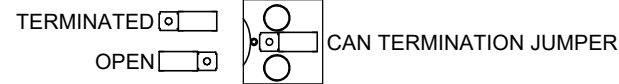
CXCI  
DETAIL A

DB9 (FOR ALPHA DC MODEM USE ONLY)	
PIN	FUNCTION
1	DCD
2	RX
3	TX
4	DTR
5	COM
6	DSR
7	RTS
8	CTS
9	RI

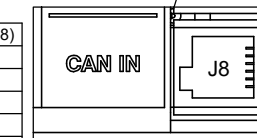
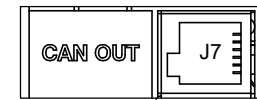
ETHERNET RJ45	
PIN	FUNCTION
1	TX+
2	TX-
3	RX+
4	NOT CONNECTED
5	NOT CONNECTED
6	RX-
7	NOT CONNECTED
8	NOT CONNECTED



CXCI+



CAN OUT RJ12 OFFSET (J7)	
PIN	FUNCTION
1	CANCOM
2	CAN H
3	NOT CONNECTED
4	CAN L
5	NOT CONNECTED
6	NOT CONNECTED



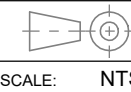
CAN IN RJ12 OFFSET (J8)	
PIN	FUNCTION
1	CANCOM
2	CAN H
3	NOT CONNECTED
4	CAN L
5	NOT CONNECTED
6	NOT CONNECTED

ITEM  
QTY



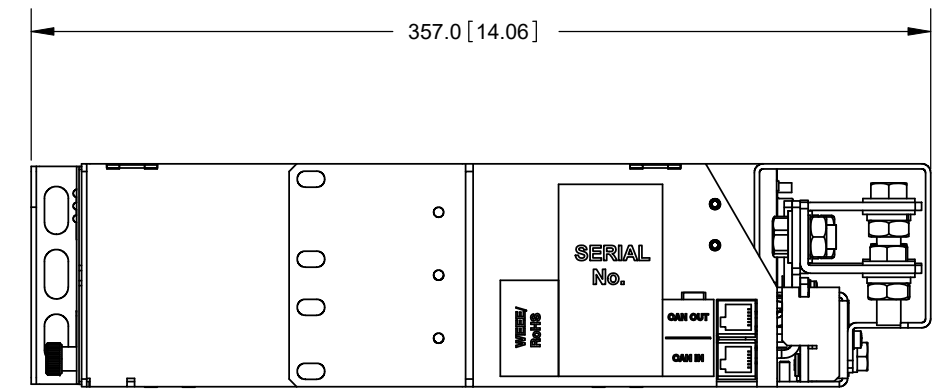
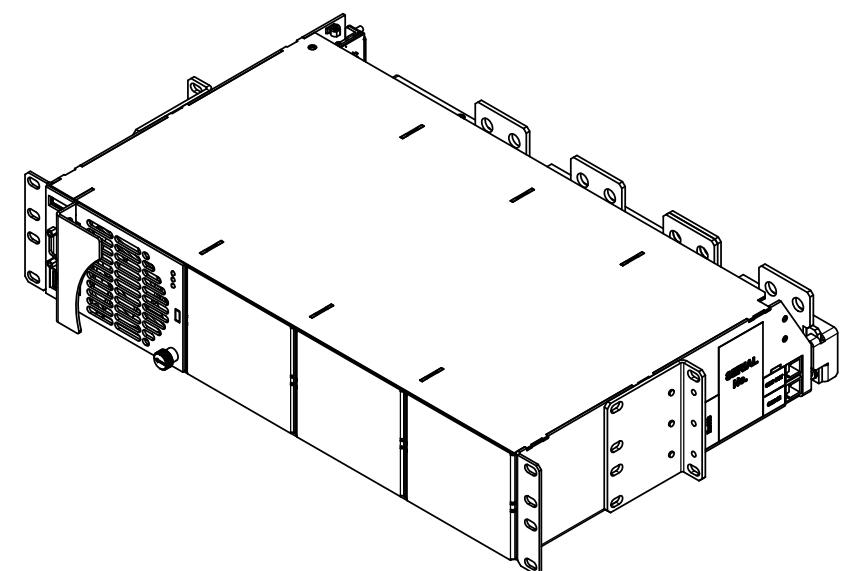
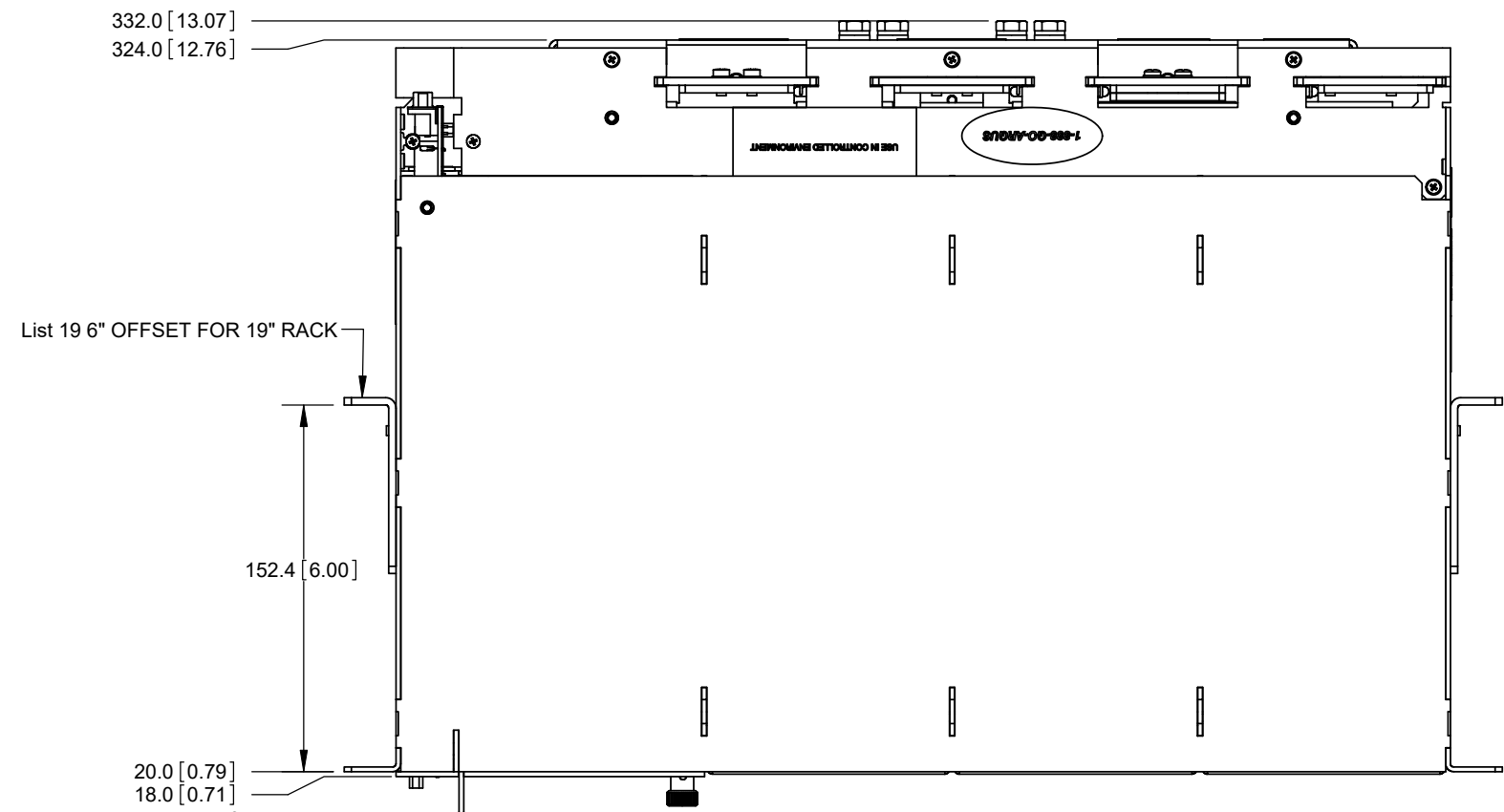
THESE DESIGNS AND SPECIFICATIONS ARE THE PROPERTY OF ALPHA TECHNOLOGIES AND SHALL NOT BE COPIED OR USED FOR MANUFACTURING WITHOUT ITS WRITTEN CONSENT.

UNITS: mm [in]	
X [X.X]	±1 [±0.040]
X.X [X.XX]	±0.5 [±0.020]
X.XX [X.XXX]	±0.05 [±0.002]
ANGULAR:	±0.5°

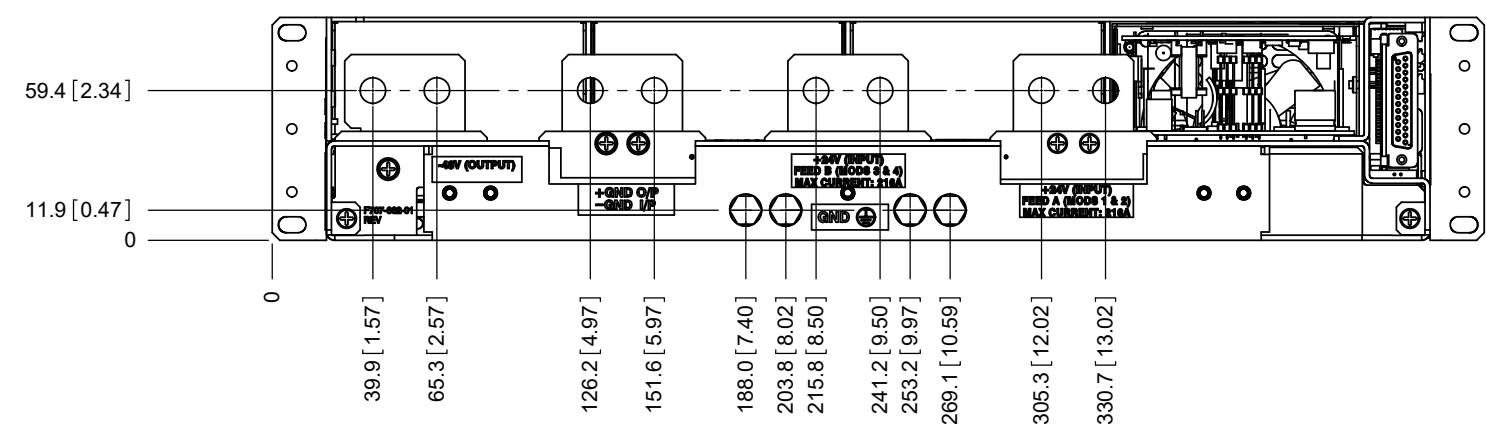
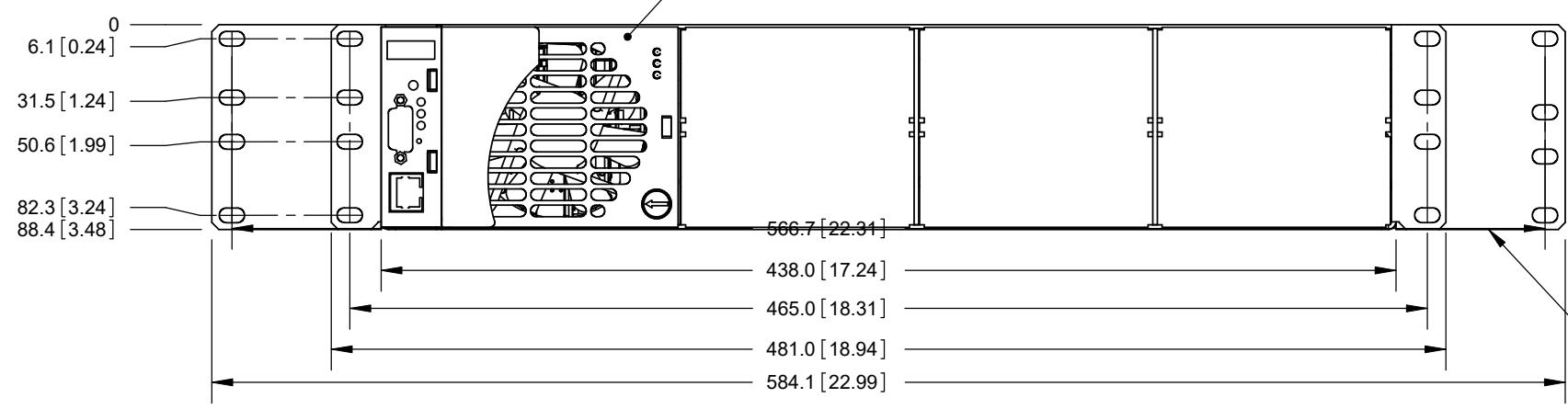


DESIGN	NAME	DATE	TITLE	SHEET
	W.H	2008/06	CUSTOMER CONNECTION SHELF 19" 4MDL CXDF 2kW	1 OF 1
DRAWN	W.H	2008/06	ISSUE DATE	
CHECKED		2008/06	SIZE TYPE DWG NO.	
APPROVED		2008/06	B D2 030-905-08	REV B

REVISIONS						
LTR	DESCRIPTION	DWN	DATE	CHKD	APPD	
B	List80, 81 ADDED, EO 10298	WH	2010/08	RP	JK	



SHOWN WITH LIST 82 & List 92 INSTALLED



ITEM  
QTY



THESE DESIGNS AND SPECIFICATIONS ARE CONFIDENTIAL. REMAIN THE PROPERTY OF ALPHA TECHNOLOGIES LTD., AND SHALL NOT BE COPIED OR USED WITHOUT ITS WRITTEN CONSENT.

UNITS: mm [in]  
X [X.X] ±1 [±0.040]  
X.X [X.XX] ±0.5 [±0.020]  
X.XX [X.XXX] ±0.05 [±0.002]  
ANGULAR: ±0.5°

SCALE: NTS

TITLE: OUTLINE DRAWING SHELF  
19" 4 MDL, CXDF 2 KW

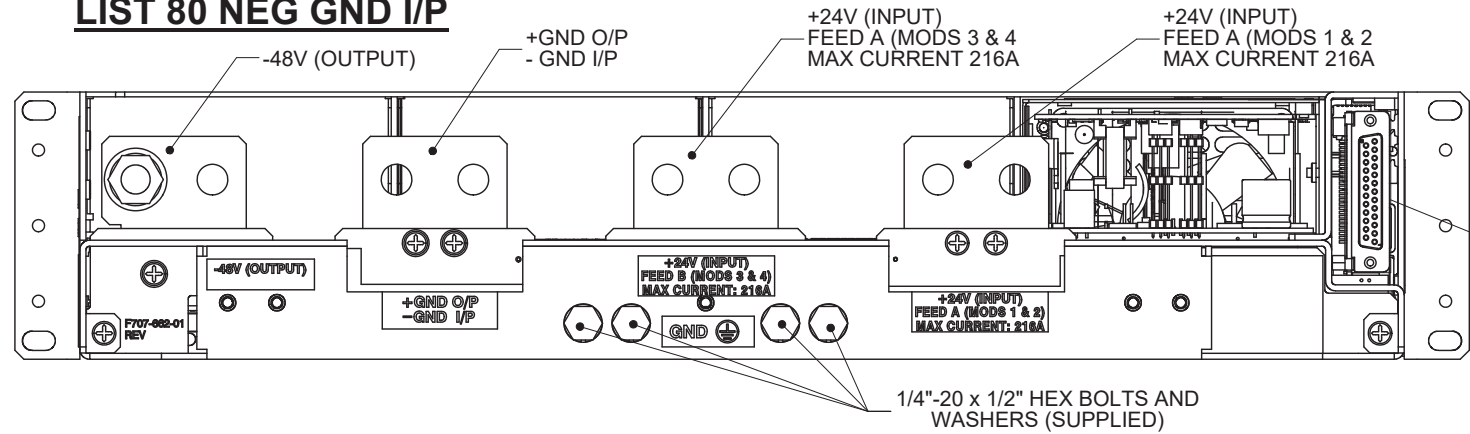
	NAME	DATE
DESIGN	W.H	2008/10
DRAWN	W.H	2009/01
CHECKED	S.Y	2009/01
APPROVED	J.K	2009/01

ISSUE DATE	SHEET	1 OF 1
SIZE TYPE DWG NO.	B	D2
030-839-06	REV	B
© 2010 ALPHA TECHNOLOGIES		



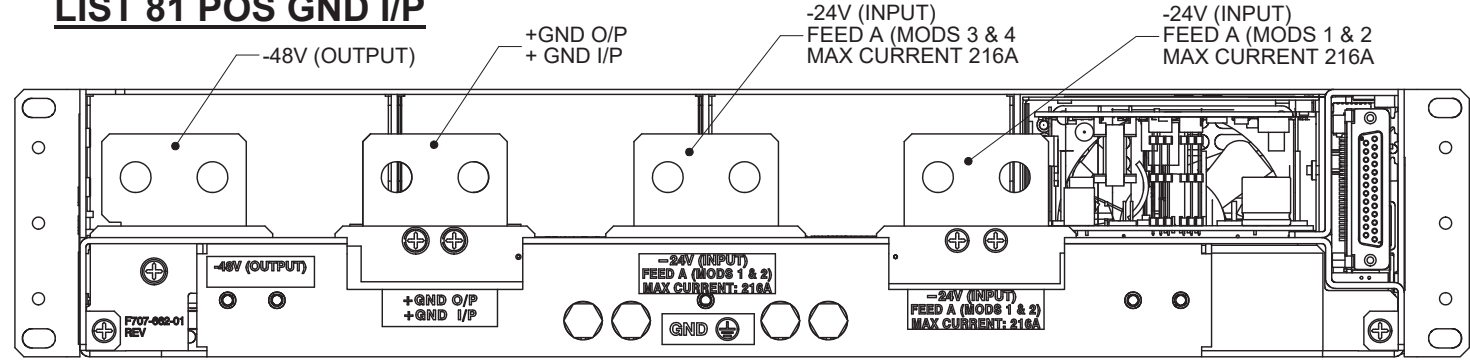
REVISIONS					
LTR	DESCRIPTION	DWN	DATE	CHKD	APPD
B	CORRECTED TABLES	SDW	2009/12	JK	ME
C	LIST 80, 81 ADDED	WH	2010/08	MP	JK
D	CXCI+ ADDED	FC	2013/12		

### LIST 80 NEG GND I/P



CXCI/CXCI+ DB-25	
PIN	FUNCTION
1	K1-COM
2	K1-NC
3	K2-COM
4	K3-NC
5	K3-NO
6	K4-COM
7	D1-1
8	D2-1
9	V1+
10	T1+
11	T2+
12	I1+
13	BATT HOT
14	K1-NO
15	K2-NC
16	K2-NO
17	K3-COM
18	K4-NO
19	K4-NC
20	D1-2
21	D2-2
22	V1-
23	T1-
24	T2-
25	I1-

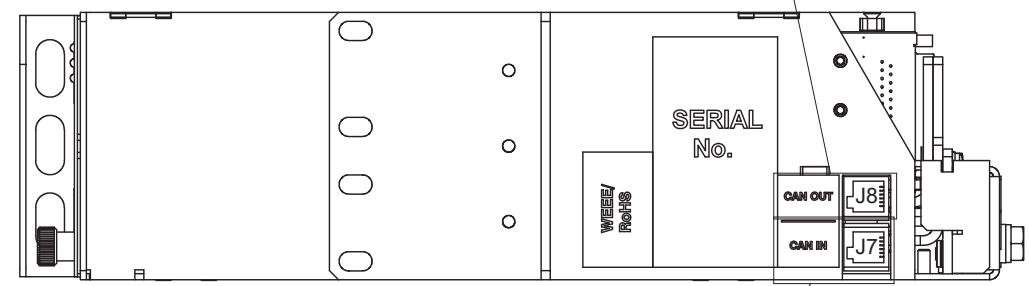
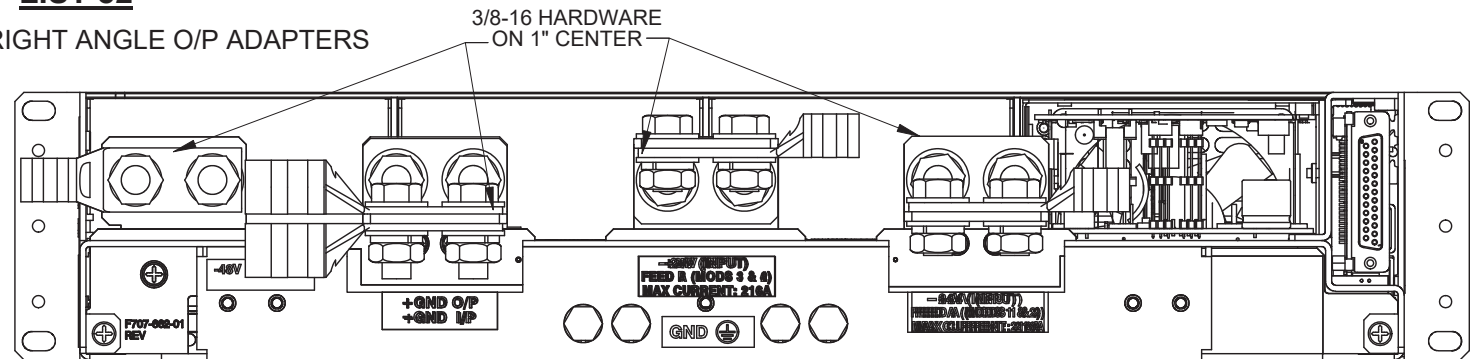
### LIST 81 POS GND I/P



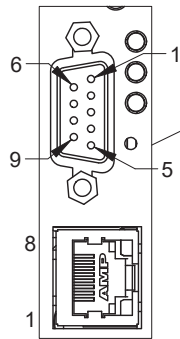
CAN OUT RJ12 OFFSET (J8)	
PIN	FUNCTION
1	CANCOM
2	CAN H
3	NOT CONNECTED
4	CAN L
5	NOT CONNECTED
6	NOT CONNECTED

### LIST 82

RIGHT ANGLE O/P ADAPTERS

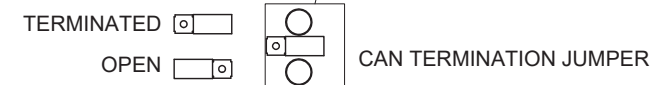
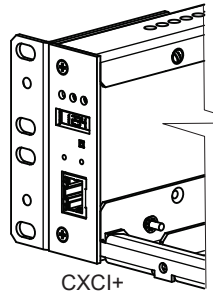


CAN IN RJ12 OFFSET (J7)	
PIN	FUNCTION
1	CANCOM
2	CAN H
3	NOT CONNECTED
4	CAN L
5	NOT CONNECTED
6	NOT CONNECTED



ETHERNET RJ45	
PIN	FUNCTION
1	TX+
2	TX-
3	RX+
4	NOT CONNECTED
5	NOT CONNECTED
6	RX-
7	NOT CONNECTED
8	NOT CONNECTED

DB9 (FOR CXCI ALPHA DC MODEM USE ONLY)	
PIN	FUNCTION
1	DCD
2	RX
3	TX
4	DTR
5	COM
6	DSR
7	RTS
8	CTS
9	RI



ITEM QTY



THESE DESIGNS AND SPECIFICATIONS ARE CONFIDENTIAL. REMAIN THE PROPERTY OF ALPHA TECHNOLOGIES LTD., AND SHALL NOT BE COPIED OR USED WITHOUT ITS WRITTEN CONSENT.

UNITS: mm [in]			
X [X.X]	±1	[±0.040]	
X.X [X.XX]	±0.5	[±0.020]	
X.XX [X.XXX]	±0.05	[±0.002]	
ANGULAR:	±0.5°		

TITLE: CUSTOMER CONNECTION SHELF 19" 4MDL CXDF 2kW DUAL FEED

	NAME	DATE
DESIGN	W.H	2009/01
DRAWN	W.H	2009/01
CHECKED	J.M	2009/01
APPROVED	J.K	2009/01

ISSUE DATE		SHEET 1 OF 1
SIZE	D2	
TYPE DWG NO.	030-839-08	REV D
© 2013 ALPHA TECHNOLOGIES		







#### Worldwide Corporate Offices

**Headquarter Germany**

Hansastraße 8  
D-91126 Schwabach  
Tel: +49 9122 79889 0  
Fax: +49 9122 79889 21  
Mail: [info@alpha-outback-energy.com](mailto:info@alpha-outback-energy.com)

**Eastern Europe**

[ee@alpha-outback-energy.com](mailto:ee@alpha-outback-energy.com)

**France and Benelux**

[fbln@alpha-outback-energy.com](mailto:fbln@alpha-outback-energy.com)

**Russia**

[russia@alpha-outback-energy.com](mailto:russia@alpha-outback-energy.com)

**Middle East**

[me@alpha-outback-energy.com](mailto:me@alpha-outback-energy.com)

**Spain**

[spain@alpha-outback-energy.com](mailto:spain@alpha-outback-energy.com)

**Africa**

[africa@alpha-outback-energy.com](mailto:africa@alpha-outback-energy.com)

Alpha and Outback Energy GmbH reserves the right to make changes to the products and information contained in this document without notice. Copyright © 2020 Alpha and Outback Energy GmbH. All Rights reserved.

For more information please visit [www.alpha-outback-energy.com](http://www.alpha-outback-energy.com)

*Power*