

Cordex 48-1.2kW Rectifier Shelf System

Technical Guide: 010-619-J0

Effective: 07/2020



Cordex 48-1.2kW Rectifier Shelf System Manual

NOTE: Photographs contained in this manual are for illustrative purposes only. These photographs may not match your installation.

NOTE: Operator is cautioned to review the drawings and illustrations contained in this manual before proceeding. If there are questions regarding the safe operation of this powering system, contact Alpha and Outback Energy GmbH or your nearest AOE representative.

NOTE: AOE shall not be held liable for any damage or injury involving its enclosures, power supplies, generators, batteries, or other hardware if used or operated in any manner or subject to any condition inconsistent with its intended purpose, or if installed or operated in an unapproved manner, or improperly maintained.

For technical support, contact Alpha and 'Outback Energy GmbH:

Tel: +49 9122 79889 0

Mail: info@alpha-outback-energy.com

Copyright

Copyright © 2018 Alpha Technologies Ltd. All rights reserved. Alpha is a registered trademark of Alpha Technologies.

No part of this documentation shall be reproduced, stored in a retrieval system, translated, transcribed, or transmitted in any form or by any means manual, electric, electronic, electromechanical, chemical, optical, or other-wise without prior explicit written permission from Alpha Technologies.

This document, the software it describes, and the information and know-how they contain constitute the proprietary, confidential and valuable trade secret information of Alpha Technologies, and may not be used for any unauthorized purpose, or disclosed to others without the prior written permission of Alpha Technologies.

The material contained in this document is for information only and is subject to change without notice. While reasonable efforts have been made in the preparation of this document to assure its accuracy, Alpha Technologies assumes no liability resulting from errors or omissions in this document, or from the use of the information contained herein. Alpha Technologies reserves the right to make changes in the product design without reservation and without notification to its users.

TABLE OF CONTENTS

1 SAFETY	1
Safety Wording/Symbols	1
General Warning and Cautions	1
Electrical Safety	1
Battery Safety	2
2 INTRODUCTION	5
Scope of the Manual	5
Product Overview	5
3 FEATURES	7
Rectifier	7
Rectifier Front Panel	7
LEDs	7
Mechanical Locking Clip	8
True Module Fail Alarm	8
Heat Dissipation	8
Over Temperature Protection	8
Wide AC Range	8
AC Inrush/Transient Suppression	9
Soft Start	9
Start Delay	9
Current Limit/Short Circuit Protection	9
Power Limiting	9
High Voltage Shutdown (HVSD)	9
Battery Eliminator Operation	9
Distribution	10
4.8kW System Distribution Module	10
3.6kW System Distribution Module	10
Overview of the CXCM1 HP	11
Display	11
In-Shelf Display: Menu	12
In-Shelf Controller Buttons	13
Overview of the CXCM1+	14
CXCM1+ Controller Front Panel	14
LCD Screen	15
LEDs	15
Reset (CXCM1+ only)	15
Ethernet Port	16
Analog Input Channels	16
Digital Input Channels	16
Alarm and Control Output Relays	16

Network Connection and Remote Communication	16
Controller Connections	17
4 INSPECTION	19
Check for Damage	19
Packing Materials	19
Returns for Service	19
5 INSTALLATION	21
Safety Precautions	21
Shelf Preparation/Mounting	21
Module Insertion/Removal	21
Removing a CXRF	22
Removing Older Model CXRF or CXCM1+	22
Removing the CXCM1 HP	23
6 WIRING AND CONNECTIONS	25
Safety Precautions	25
Tools Required	25
AC Feeder Protection/Sizing	25
AC Input	26
Strain Relief	26
Calculating Output Wire Size Requirements	27
DC Output	27
DC Output for Model 030-851-20 (maximum 3600W)	27
DC Output for Model 0300165 (maximum 4800W)	29
DC Output for Model 030-835-20/ 030-845-20 (bulk distribution)	32
CAN Ports	32
Network Connection and Remote Communications via the Controller	32
Ethernet Port for Network Connection	32
Ethernet Port for Local Connection	32
Signal Wiring Connections	32
Analog Inputs	33
Digital Inputs	33
Alarm (Relay) Outputs	34
LVD Control (Load Disconnect or Battery Disconnect)	35
LVD Control Alternative	35
7 OPERATION	37
Main Rectifier States	37
Off	37
Start Delay	37
Soft Start	37
Normal Operation	37
Turning Off	38

Main Rectifier Modes	38
Output Voltage Modes	38
Output Current/Power Modes	38
CAN Bus Communication	39
Factory Ranges and Defaults	39
8 SYSTEM STARTUP	41
Check System Connections	41
Verify AC and Power The Shelf	41
Check Battery Polarity and Connect	41
Controller Reset	41
Soft Reset (CXCM1+ only)	41
IP Address Reset (CXCM1+ only)	41
Hard Reset	42
Accessing the LVD Jumper	42
9 MAINTENANCE	43
Rectifier Fan Replacement	43
10 WARRANTY AND SERVICE INFORMATION	45
Technical Support	45
Warranty Statement	45
Product Warranty	45
Battery Warranty	45
Warranty Claims	45
Service Information	45
11 CERTIFICATION	47
12 GLOSSARY	49
13 SPECIFICATIONS	51
Cordex HP 48 1.2kW Switched Mode Rectifier	51
CXCM1 HP Controller	54
CXCM1+ Controller	56

LIST OF FIGURES

Figure 1: Single Shelf 6

Figure 2: Dual Shelf. 6

Figure 3: 2RU Shelf. 6

Figure 4: Rectifier Front Panel 7

Figure 5: 4.8kW System Distribution Module10

Figure 6: 3.6kW System Distribution Module10

Figure 7: CXCM1 HP Controller11

Figure 8: In-Shelf Controller Dashboard Screens.12

Figure 9: In-Shelf Controller Menu12

Figure 10: In-Shelf Controller Buttons: Vertical Mount13

Figure 11: In-Shelf Controller Buttons: Horizontal Mount13

Figure 12: Cordex CXCM1+ model system controller front panel15

Figure 13: Packing Materials and Environmental Codes19

Figure 14: Removing a Rectifier from the Shelf22

Figure 15: Removing a CXRF or CXCM1 or CXCM1+.23

Figure 16: Removing the CXCM1 HP24

Figure 17: AC input, CAN, and signal connections (4800W system)26

Figure 18: AC Cord Strain Relief for IRU Shelves27

Figure 19: DC Output Connections28

Figure 20: DC Output to Batteries29

Figure 21: DC Output Connections (Four Load Breaker Configuration shown)30

Figure 22: Breaker Return Connections (Four Load Breaker Configuration shown). .31

Figure 23: Front View of Distribution Module (Four Load Breaker Configuration shown)31

Figure 24: Signal Wiring Terminal Blocks (030-851-20 shown)33

Figure 25: Digital Input Connection Method34

Figure 26: Relay Connections34

Figure 27: Rectifier Fan Replacement43

LIST OF TABLES

Table 1: In-Shelf Controller Full Menu12

Table 2: Recommended AC Supply Configuration.26

Table 3: Voltage Level Definitions for Digital Inputs34

Table 4: Output Voltage Modes38

Table 5: Output Current/Power Modes.38

Table 6: Factory Ranges and Defaults.39

Table 7: Sample Maintenance Log.43

Table 8: Specifications: Cordex HP 48 1.2kW, Switched Mode Rectifier51

Table 9: Specifications: CXCM1 HP Controller54

Table 10: Specifications: CXCM1+ Controller.56

1 Safety

SAVE THESE INSTRUCTIONS: This manual contains important safety instructions that must be followed during the installation, servicing, and maintenance of the product. Keep it in a safe place. Review the drawings and illustrations contained in this manual before proceeding. If there are any questions regarding the safe installation or operation of this product, contact Alpha Technologies or the nearest Alpha representative.

1.1 Safety Wording/Symbols

To reduce the risk of injury or death, and to ensure the continued safe operation of this product, the following symbols have been placed throughout this manual. Where these symbols appear, use extra care and attention.

ATTENTION: *The use of attention indicates specific regulatory/code requirements that may affect the placement of equipment and /or installation procedures.*

NOTE: *Notes provide additional information to help complete a specific task or procedure.*

CAUTION: *Cautions indicate safety information intended to PREVENT DAMAGE to material or equipment.*

WARNING: *Warnings present safety information to PREVENT INJURY OR DEATH to personnel.*

NOTE: *HOT! The use of Hot presents safety information to PREVENT BURNS to the technician or user.*

1.2 General Warning and Cautions

WARNING: *You must read and understand the following warnings before installing the system and its components. Failure to do so could result in personal injury or death.*

- Read and follow all instructions included in this manual.
- Only trained personnel are qualified to install or replace this equipment and its components.
- Use proper lifting techniques whenever handling equipment, parts, or batteries.
- To be installed in a restricted access location that is inaccessible to the general public.

1.3 Electrical Safety

WARNING: *Hazardous voltages are present at the input of power systems. The DC output from some rectifiers and batteries can have high voltage and high short-circuit current capacity that may cause severe burns and electrical arcing.*

Before working with any live battery or power system, follow these precautions:

- Remove all metallic jewelry, such as watches, rings, metal rimmed glasses, or necklaces.
- Wear safety glasses with side shields at all times during the installation.
- Use OSHA approved insulated hand tools. Do not rest tools on top of batteries.

WARNING: Lethal voltages are present within the power system. Always assume that an electrical connection or conductor is energized. Check the circuit with a voltmeter with respect to the grounded portion of the enclosure (both AC and DC) before performing any installation or removal procedure.

- Do not work alone under hazardous conditions.
- A licensed electrician is required to install permanently wired equipment. Input voltages can range up to 240Vac. Ensure that the utility power is disconnected and locked out before performing any installation or removal procedure.
- Ensure that no liquids or wet clothes come into contact with internal components.
- Hazardous electrically live parts inside this unit are energized from the batteries even when the AC input power is disconnected.
- The enclosure which contains the DC or AC power system along with customer installed radios must remain locked at all times, except when authorized service personnel are present.
- Always assume electrical connections or conductors are live. Turn off all circuit breakers and double-check with a voltmeter before performing installation or maintenance.
- Place a warning label on the utility panel to warn emergency personnel that a reserve battery source is present which will power the loads in a power outage condition or if the AC disconnect breaker is turned off.
- At high ambient temperature conditions, the internal temperature can be hot so use caution when touching the equipment.

WARNING: The intra-building ports (Ethernet, CAN, Alarm relays) of the equipment or subassembly are suitable for connection to intra-building or unexposed wiring or cabling only. The intra-building ports of the equipment or subassembly **MUST NOT** be metallically connected to interfaces that connect to the OSP or its wiring. These interfaces are designed for use as intra-building interfaces only (Type 2 or Type 4 ports) and require isolation from the exposed OSP cabling. The addition of Primary Protectors is not sufficient protection in order to connect these interfaces metallically to OSP wiring.

WARNING: Controller Ethernet port is not designed to withstand lightning and AC power cross surges according to the NEBS requirements in GR-1089-CORE. Ensure that any Ethernet cable used (not provided by Alpha) does not exceed a maximum length of 6 meters.

1.4 Battery Safety

- Never transport an enclosure with batteries installed. Batteries must **ONLY** be installed after the enclosure has been securely set in place at its permanent installation location. Transporting the unit with batteries installed may cause a short circuit, fire, explosion, and/or damage to the battery pack, enclosure and installed equipment.
- Servicing and connection of batteries must be performed by, or under the direct supervision of, personnel knowledgeable of batteries and the required safety precautions.
- Batteries contain or emit chemicals known to cause cancer and birth defects or other reproductive harm. Battery post terminals and related accessories contain lead and lead compounds. Wash your hands after handling batteries.

WARNING: Follow battery manufacturer's safety recommendations when working around battery systems. Do not smoke or introduce an open flame when batteries (especially vented batteries) are charging. When charging, batteries vent hydrogen gas, which can explode.

- Batteries are hazardous to the environment and should be disposed at a recycling facility. Consult the battery manufacturer for recommended local authorized recyclers.

2 Introduction

2.1 Scope of the Manual

This manual explains the installation, interconnection, and operation of the Alpha Cordex CXRF-HP 48-1.2 kW 48Vdc power and distribution systems that contain the CXCM1 series of controllers (includes CXCM1+ and CXCM1 HP).

2.2 Product Overview

These 48Vdc power and distribution systems incorporate the high performance (HP) series of 48V 1.2kW Cordex rectifier modules and are specifically designed for restricted space installation. Cordex rectifier modules use a high frequency, switched mode conversion technique to provide a fully regulated and isolated DC output from the AC mains. The rectifier module input is universal to allow use on 120/208/220/240Vac 50/60Hz electrical service. The front access design, allows for all customer connections in front of the rack channel.

- Rectifier power modules are “hot swappable”—they can be inserted or removed from the shelf without cutting power to or from the system or the load.
- Additional power modules can be added to the system at the time of ordering or after the shelf has been installed.
- The shelves are designed for horizontal mounting in a 19" or 23" center mount (flush mount for 1RU shelves) installation via universal mounting brackets (EIA rack spacing) and utilize dual IEC-type connectors for multiple AC line cord solutions.
- The Alpha CXCM1 HP was designed as a modular, high performance controller for the rectifier series.
- All controllers models allow the user to set up, control and monitor the entire power system and ancillary components from one central, easy-to-use source. Details of controller operation are provided in the current version software manual.
- The equipment is suitable for installation in network telecommunication facilities.

The following figures are examples of:

1. CXRF-HP 48-1.2 kW 1RU 19" shelf system, with 3 rectifier modules up to 3.6kW output power, controller and GMT fuse distribution
2. CXRF-HP 48-1.2 kW 2RU 19" shelf system, with (a) 4 rectifier modules up to 4.8kW output power and controller (top shelf) and (b) 5 rectifier modules up to 6.0kW output power (lower shelf)
3. CXRF-HP 48-1.2kW 2RU 19" shelf system, with 4 rectifier modules up to 4.8kW output power, controller and breaker/GMT fuse distribution

Figure 1: Single Shelf



Figure 2: Dual Shelf



Figure 3: 2RU Shelf



3 Features

3.1 Rectifier

The Cordex CXRF-HP series of 48V 1.2kW rectifier modules employ high frequency, switch mode technology featuring high power conversion efficiency. All internal semiconductor devices operate under “soft-switching” conditions and exhibit very low power loss. The reduced power loss leads to lower thermal stress on the semiconductors and thus improves reliability.

Sustaining low component temperatures is again the primary factor with meeting the three worst-case field scenarios: (1) 65°C ambient temperatures, (2) full output power, and (3) low AC input (176Vac). While meeting these specifications, Cordex rectifiers also offer roughly twice the reliability at 55°C and up to four times more at 45°C ambient temperature.

3.1.1 Rectifier Front Panel

Figure 4: Rectifier Front Panel



3.1.2 LEDs

The front panel LEDs provide rectifier status summary and help to locate a specific module with the controller.

AC

The top LED (green) is on when AC is within valid range and the rectifier is delivering power to the load. The LED will flash (~2Hz) when AC is outside the nominal range – AC voltage is invalid if the AC Mains Low or AC Mains High alarm is active. The LED turns off when AC has failed (or no AC power is present).

DC

The middle LED (green) is on when the rectifier is delivering power to the load. The LED turns off when the rectifier is off; e.g., when commanded via the controller.

Alarm

The bottom LED (red) is on continuously in the event of an active Module Fail alarm. The LED flashes (~2Hz) when a minor alarm is detected. The LED remains off in the absence of an alarm. If the unit output is not connected to a battery or parallel rectifier, the LED extinguishes if no AC power is present.

LED Activity During “Locate Module” Command from Controller

When the “locate module” command has been received from the controller, the LEDs behave in a distinctly different way so that the rectifier is easier to visually identify among adjacent rectifiers.

This state is entered when commanded via the controller. The LEDs flash in a distinct pattern repeating every two seconds.

LED Activity During Firmware Upload

When a rectifier firmware upload is in progress, the LEDs behave in the same way as the locate module command described above.

3.1.3 Mechanical Locking Clip

A locking clip automatically secures the rectifier into the shelf.

3.1.4 True Module Fail Alarm

The power modules have a “true” fail alarm. This provides a true indication of the power module’s ability to source current. When the module’s output current drops below 2.5% of the rated output a low output current condition is detected and the Module Fail detection circuit is activated. This circuit momentarily ramps up the output voltage to determine if the module will source current. If no increase in current is detected, the Module Fail alarm is activated. The module will test once every 60 seconds for the condition until current is detected. Output voltage ramping will cease upon detection of current¹. A minimum 2.5% load is required to avoid the Ramp Test Fail alarm; this can typically be provided with the parallel system battery. Activation of this alarm could indicate a failed module or a failed load.

NOTE: For Cordex rectifier systems without batteries (or with a very light load; below 2.5% of rated output) it is recommended that the ramp test be disabled to avoid nuisance alarms. The Ramp Test feature is enabled/disabled via the controller. Refer to the software manual for detailed information.

3.1.5 Heat Dissipation

Cooling of the module is front-to-rear with the exhaust air exiting at the back. The fan is variable speed; which is determined by heatsink temperature and load.

3.1.6 Over Temperature Protection

Each rectifier module is protected in the event of an excessive increase in temperature due to component failure or cooling airflow blockage. During over temperature conditions, the rectifier limits the output power as well as the output current. If temperature continues to increase, a shutdown of the rectifier is initiated. The rectifier shall restart automatically if the temperature has returned to a safe level.

3.1.7 Wide AC Range

A minor alarm is generated when the AC input voltage drops below specification.

- Output power is reduced linearly between 176Vac and 132Vac to 60% of the rated output power.
- Input current is limited to less than 6A for operation from 132Vac to 90Vac. Power is derated linearly between 132Vac (~700W) to 90Vac (~475W).
- At a lower voltage the module will shut down and will not restart until the AC is greater than 90Vac.

1. Under normal conditions, a battery connected to the output of the rectifier will draw current when the voltage ramp occurs. Therefore the rectifier fail alarm will not be generated with a battery connected.

- For voltages above 277Vac, power factor and total harmonic distortion may be derated. Up to 320Vac, the rectifier may not be operational but shall not suffer any damage.

3.1.8 AC Inrush/Transient Suppression

An external surge suppressor is not required at the AC input, modules are protected from input lightning and transient surges in accordance with IEEE/ANSI C62.41 Category B3.

3.1.9 Soft Start

To eliminate an instantaneous demand on the AC source, a soft start feature is employed. Soft Start, sometimes referred to as “current walk-in”, works by gradually (up to five seconds) ramping the current limit up from zero to the actual or defined customer setting. The rectifier output voltage is ramped up from the minimum voltage to the float voltage.

3.1.10 Start Delay

The rectifier modules are equipped with a delay timer in order to stagger start a series of modules to prevent excessive loading of generators upon start up. The built-in timer delays the turn on of the module depending on the value selected (up to 120 seconds) via the controller. A minimum one-second delay is preset to allow charging of the input capacitors.

3.1.11 Current Limit/Short Circuit Protection

The current limit function determines the maximum output current limit of the rectifier module, regardless of output voltage or power. Maximum output current is limited to a constant value down to short circuit condition. Current limiting can be used to mate the rectifier output current ampacity to the needs of the load and parallel battery to minimize excessive battery recharge current.

The rectifier will sustain a short circuit at the output terminals indefinitely. The maximum short circuit current cannot exceed 105% of the rated full load current.

3.1.12 Power Limiting

Each rectifier module is designed to limit power output to the module specification. This enables more current to be supplied at lower output voltages, and allows matching of output to the demand of constant power loads, normally seen with telecom equipment.

This feature may also be used for a faster recharge of flooded batteries paralleled with the load.

NOTE: Current limiting overrides the power-limiting feature.

3.1.13 High Voltage Shutdown (HVSD)

This feature provides protection to the load from over voltage conditions originating from the rectifiers. It operates by shutting down the offending rectifier module when a high output voltage condition occurs. Indication is through the red Alarm (Module Fail) LED. Modules will restart automatically; however, if more than three over voltage conditions occur in one minute, the module will latch off and remain shut down until it is reset.

3.1.14 Battery Eliminator Operation

Rectifier modules maintain all specifications (except where indicated) with or without a battery attached in parallel to the output; however, if a battery or another module supplying DC voltage in parallel is not present, there will be no monitoring or control activity if there is an AC power failure or input fuse failure.

3.2 Distribution

3.2.1 4.8kW System Distribution Module

0300165 (Cordex CXRF-HP 48-1.2kW center mounting 2RU shelf for systems up to 4.8kW)

The distribution component uses up to four bullet-type breakers that can be factory configured for either 4 load breakers or 2 load/2 battery breakers, and up to ten GMT fuse positions. The distribution module also allows for termination of two battery strings and includes a 150A battery shunt. Also available as an option is a 100A low voltage battery disconnect.

This module contains a unique sliding connection point system to allow for the several dual-hole lug terminations in a compact space. See Wiring and Connections chapter of this manual for more details.

Figure 5: 4.8kW System Distribution Module



3.2.2 3.6kW System Distribution Module

030-851-20 (Cordex CXRF-HP 48-1.2kW, 19" 1RU shelf, 3 modules, w/ GMT fuses up to 3.6kW)

The shelf incorporates a distribution module for DC fuse output as well as battery connections. The module accommodates up to eight GMT fuse positions (limited to 40A maximum). Two battery-landing positions and an 80A battery shunt are also provided.

The module has low voltage disconnect (LVD) options, which are in series with either the battery or the load.

The GMT fuse output connection points are accessible from the front of the module via plug-in connectors. The battery connections are accessible from the rear of the module via 2-hole lug inputs.

Figure 6: 3.6kW System Distribution Module



3.3 Overview of the CXCM1 HP

CXC HP in-shelf controllers have a small organic LED (OLED) display. This display shows 30 characters total (five lines high, six characters wide) and the controller has three navigation buttons and one reset button.

The in-shelf display has three main operating modes: dashboard, menu and screen saver. After 20 minutes with no activity, the in-shelf controller goes into screen saver mode and the display shuts off. From screen saver mode, press any of the three navigation buttons to re-activate the screen and enter dashboard mode.

Figure 7: CXCM1 HP Controller

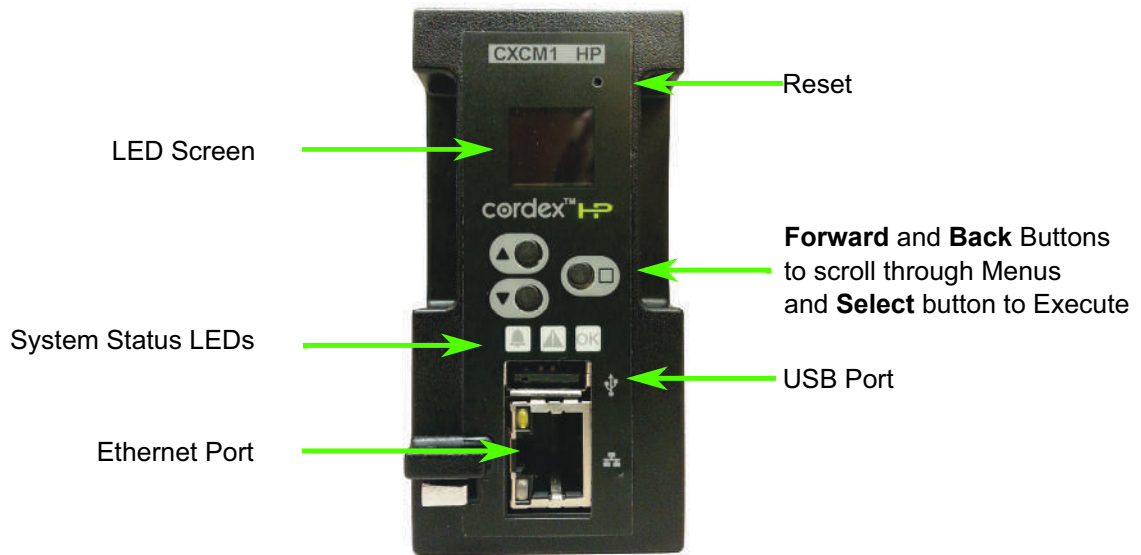

3.3.1 Display

In dashboard mode, the in-shelf display shows the key operating parameters of a system. For example, output voltage and load current. If more than one system is defined, you can cycle between systems using the **Forward** and **Back** buttons. With multiple systems, you can specify a default system, which is then displayed first.

Refer to the software manual for set up.

The following figure below shows examples of the screens.

Figure 8: In-Shelf Controller Dashboard Screens

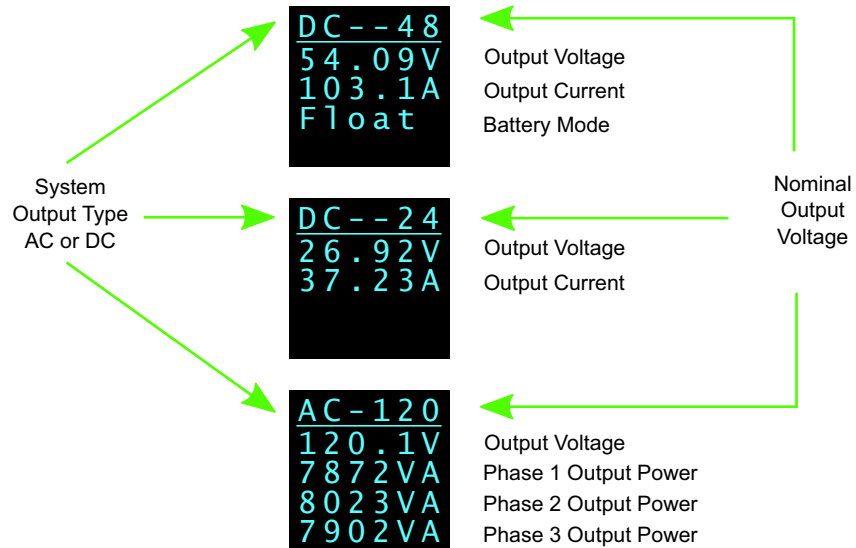

3.3.2 In-Shelf Display: Menu

From the dashboard, use the **Select** button to enter a menu. From the menu, the OLED display lets you execute a set of commands much like the LCD screens on the CXC HP.

When you enter a menu, the top item is highlighted. To go to another menu scroll through using the **Forward** and **Back** buttons. To execute a highlighted menu item, press the **Select** button.

To exit a menu and return to the main dashboard, scroll to the **Back** command, and then press the **Select** button. The figure below shows an example of the menu screen. The following table provides a full list of menus available via the in-shelf display.

Figure 9: In-Shelf Controller Menu



Table 1: In-Shelf Controller Full Menu (Sheet 1 of 2)

Menu Label	Description
ALCO	Perform the alarm cut-off command
Reset	Perform a software reset of the controller
IPv4	Display the IPv4 address, subnet and gateway for this controller
IPv6	Display the IPv6 addresses assigned to this controller

Table 1: In-Shelf Controller Full Menu (Continued) (Sheet 2 of 2)

Menu Label	Description
Backup	Backup the controller application and configuration to a file on a USB device
Restore	Restore the controller application and configuration from a file on a USB device
Upgra...	Upgrade the controller application from a file on a USB device
OS Upg	Upgrade the controller's operating system from a file on a USB device
Info	Display controller information including serial number, part number, software and hardware version
Rotate	Rotate the in-shelf controller display information by 90 degrees
Back	Exit the menu and return to the dashboard

3.3.3 In-Shelf Controller Buttons

The in-shelf controller can be mounted vertically or horizontally. The contents of the display can be rotated, but the buttons cannot be rotated. The following figures show how the buttons are interpreted for both mounting options.

Figure 10: In-Shelf Controller Buttons: Vertical Mount

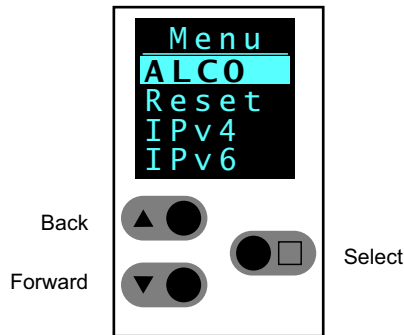
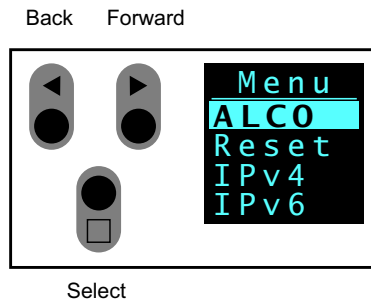

Figure 11: In-Shelf Controller Buttons: Horizontal Mount



3.4 Overview of the CXCM1+

The Cordex controller is mounted in the rectifier system shelf bringing advanced monitoring technology to the rectifiers. This compact system controller is designed for seamless operation and set up of Alpha power systems, and is equipped with the complete range of software features, including the following:

- Designed to communicate directly with Cordex rectifiers
- Includes battery temperature compensation charging
- Battery performance diagnostics
- Provides local and remote communications
- User definable alarms
- Daily logging of power system events and system statistics

The main controller motherboard, located behind the Cordex controller front panel, contains a microprocessor, memory, and other electronic components.

The Cordex controller includes a web server that provides easy set up and monitoring using an Internet connection with the standard web browser.

The data-logging feature allows the user to capture data from multiple inputs, for AC/DC voltages, load/battery current, cell voltages and temperatures (automatically for up to 16 user defined logs). Typical applications of the Cordex controller logging include power system details, thermal performance of outdoor enclosures, battery cell specifics, or mains variations captured by an AC voltage watchdog.

A built-in audio speaker sounds an intermittent tone during active alarms and the input/output (I/O) board houses a series of terminal connections.

NOTE: Customer settings for the CXCM1+ are provided separately in the system documentation package.

3.4.1 CXCM1+ Controller Front Panel

The CXCM1+ has a 4-digit display for monitoring system voltage (V) and current (A). A pushbutton toggle switch allows the user to alternate the display reading.

Figure 12: Cordex CXCM1+ model system controller front panel

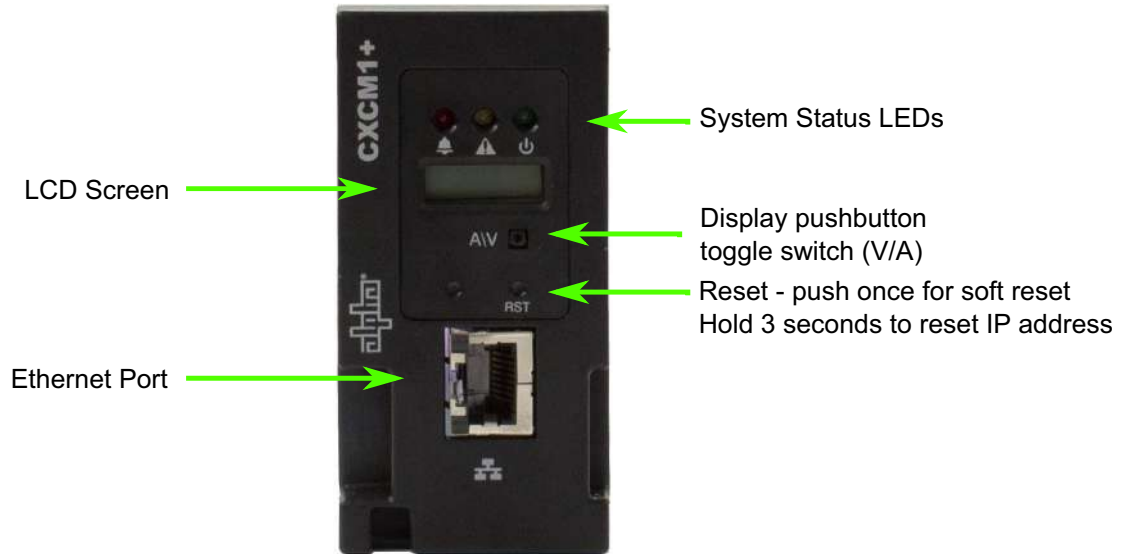

3.4.2 LCD Screen

The controller front panel uses a 4-digit LCD screen to monitor the system voltage (V) and current (A). A push-button toggle switch allows the user to alternate the display reading.

3.4.3 LEDs

The controller has three LEDs located on the front panel. These are used to display the alarm status of the power system, controller progress and status during startup, file transfers and lamp tests.

Alarm Conditions

The controller illuminates the LED that corresponds to the alarm status. Only one LED is illuminated at a time during alarm conditions:

- Green: OK, no alarms present
- Yellow: Minor alarm is present (no major alarms)
- Red: Major alarm is present.

Progress and Status Indication

The LEDs are also used in the following situations:

- Base unit validation: All three LEDs on simultaneously
- File transfer: Red LED illuminates when recovering from invalid firmware application
- Lamp Test: All three LEDs flash in sync for two seconds

3.4.4 Reset (CXCM1+ only)

A reset button is located on the front panel for restarting the controller. During reset, the controller may occasionally need to run a defragmentation cycle. This can be recognized by the LEDs cycling on the

front panel. A full defragmentation may take up to 20 minutes to perform, do not power down the controller during this time.

NOTE: Refer also to the software manual – always select the Reset menu item before pressing the reset button.

3.4.5 Ethernet Port

The Ethernet port is designed for connection to a user supplied network (TCP/IP secured by user) via a front panel RJ-45 jack and a standard network cable.

Local access (e.g. laptop computer) is also possible from the Ethernet port connection using a standard network cable.

3.4.6 Analog Input Channels

The controller is provided with analog input channels for voltage, current, and temperature.

Voltage Inputs

Two voltage input channels, V1 and V2, provide monitoring of discharge and charge voltage. The controller software is pre-configured to monitor V1 for battery voltage and V2 for load voltage.

V2 is wired internally to the rectifier shelf to provide a reference for rectifier float voltage, low voltage disconnect (LVD), system high voltage alarm, and system low voltage alarm.

Wire V1 to battery to monitor battery voltage or change battery setting from V1 to V2 in **Signals > Configure Signals**.

Current Inputs

The controller software is pre-configured to monitor I1 for battery current wired internally to the battery current shunt.

Temperature Inputs

Two temperature input channels, T1 and T2, provide monitoring of battery temperature and temperature compensation (temp comp) or room/ambient temperature. A voltage is supplied to these terminals to power the temperature sensors.

3.4.7 Digital Input Channels

The controller can accommodate up to two channels and can monitor digital alarm/control signals from rectifiers, converters and many other types of equipment.

3.4.8 Alarm and Control Output Relays

The controller contains seven Form C digital alarm output relays to extend alarms and control external apparatus. Each internally generated alarm or control signal may be mapped to any one of the relays, or, several signals may be mapped to just one relay or none at all.

3.4.9 Network Connection and Remote Communication

The Cordex system can be set up, monitored and tested via an Ethernet connection. The communication protocol supports a web interface. All alarming and control of Cordex rectifiers is accomplished with a controller via a CAN bus.

A step-by-step connection wizard – provided to establish remote communications with your controller – is available via the Alpha website (<http://www.alpha.ca/downloads>).

3.4.10 Controller Connections

Next to the CXCM1+, on the left side of the shelf, are terminal block connections for the system control I/O; such as, digital signals, analog inputs, and alarm relay outputs.

4 Inspection

The inventory included with your shipment is dependent upon the options you have ordered. The options are clearly marked on the shipping container labels and on the bill of materials (BOM).







4.1 Check for Damage

Prior to unpacking the product, note any damage to the shipping container. Unpack the product and inspect the exterior for damage. If any damage is observed contact the carrier immediately. Continue the inspection for any internal damage. In the unlikely event of internal damage, inform the carrier and contact Alpha Technologies for advice on the impact of any damage.

4.2 Packing Materials

Alpha is committed to providing products and services that meet our customers' needs and expectations in a sustainable manner, while complying with all relevant regulatory requirements. As such Alpha strives to follow our quality and environmental objectives from product supply and development through to the packaging for our products. Rectifiers and batteries are shipped on individual pallets and are packaged according to the manufacturer's guidelines. Almost all of Alpha's packaging material is from sustainable resources and or is recyclable. See the following table for the material and its environmental codes.

Figure 13: Packing Materials and Environmental Codes

 PAP/PCB	 PET	 PE-LD	 PS	 FE	 ALU	 NW
Cardboard	Polyethylene Terephthalate	Low Density Polyethylene	Polystyrene	Steel	Aluminum	Wood
Packing boxes Caps	Flexible film Packaging	Bubble wrap Shrink wrap Plastic bags	Foam	Strapping on pallets	Strapping on pallets	Pallets Lumber

4.3 Returns for Service

Save the original shipping container. If the product needs to be returned for service, it should be packaged in its original shipping container. If the original container is unavailable, make sure that the product is packed with at least three inches of shock-absorbing material to prevent shipping damage. Alpha Technologies is not responsible for damage caused by improper packaging of returned products.

If you have any questions before you proceed, call Alpha Technologies: 1 888 462-7487.

5 Installation

NOTE: This power system is suitable for installation in Network Telecommunication Facility locations where the NEC applies, and in OSP applications.

This chapter is provided for qualified personnel to install the product. Mount the unit horizontally in a clean and dry environment.

NOTE: Drawings are located at the rear of the manual.

This system is designed to be installed in a restricted access location that is inaccessible to the general public.

5.1 Safety Precautions

***WARNING:** Hazardous voltages are present at the input of power systems. The DC output from the rectifiers and battery system, though not dangerous in voltage, has a high short circuit current capacity that may cause severe burns and electrical arcing.*

Before working with any live battery or power system/distribution center, follow these precautions:

- Remove all metallic jewelry; e.g., watches, rings, metal rimmed glasses, necklaces.
- Wear safety glasses with side shields (and prescription lenses if necessary) at all times during installation.
- Use insulated hand tools.

The installer should follow all applicable local rules and regulations for electrical and battery installations; e.g., CSA, UL, CEC, NEC, OSHA, and local fire codes.

5.2 Shelf Preparation/Mounting

NOTE: The shelf is designed for horizontal mounting in a clean and dry environment. Allow at least 1.75" of free space in front of the unit for unrestricted cooling airflow.

Each shelf has been designed for center mounting in a 19" or 23" rack (or flush mount for 1RU shelves). See drawings at the end of this manual.

Mounting brackets accommodate either 1" or 1¾" rack spacing. Mount the shelf to the rack using at least two #12 – 24 x ½" screws in each bracket. Use Phillips-type screws and screwdriver to eliminate the possibility of slippage and scratching of the unit's exterior.

An electrical conducting path must exist between the unit's chassis and the metalwork of the enclosure in which it is mounted or a grounding conductor. The electrical continuity requirement can be met by the use of thread-forming type unit mounting screws and star washers that remove any paint or non-conductive coatings and establish metal-to-metal contact.

5.3 Module Insertion/Removal

The rectifier is plug and play. When a rectifier module is added to the system, the controller will detect and update the inventory automatically. Replacing an installed rectifier requires a manual **Inventory Update** at the controller to clear the removed rectifier from its current list of rectifiers.

Insert rectifiers by placing the module on the shelf bottom and sliding the module into the rear connector (inside of the shelf). Apply pressure on the front of the module to engage the rear connector in the shelf receptacle. A locking clip is provided to secure the rectifier into the shelf.

NOTE: Do not force a module into position if it does not seat properly. All modules are keyed to ensure that the correct module (polarity/voltage) type is used.

5.4 Removing a CXRF

1. To remove a module, push up and hold the latch, and then slide the module out of the shelf.

Figure 14: Removing a Rectifier from the Shelf



2. Place the new rectifier module on the shelf bottom and slide the module into the rear connector (inside the shelf).
3. Apply pressure to the module front panel to engage the rear connector in the shelf receptacle.
4. The latch automatically secures the rectifier to the shelf.
5. Refer to the respective controller software manual to perform an inventory update or module assignment.

5.5 Removing Older Model CXRF or CXCM1+

To remove a module, insert a 1/8" x 4 flat head screwdriver into the slot located on the bottom left corner of the front plastic panel. With one hand, turn the screwdriver clockwise approximately 30 degrees to move the clip from the resting state (locked position). With the other hand, grasp the ledge of the finger opening on the front panel to pull the module away from the rear connector and out of the shelf.

Figure 15: Removing a CXRF or CXCM1 or CXCM1+

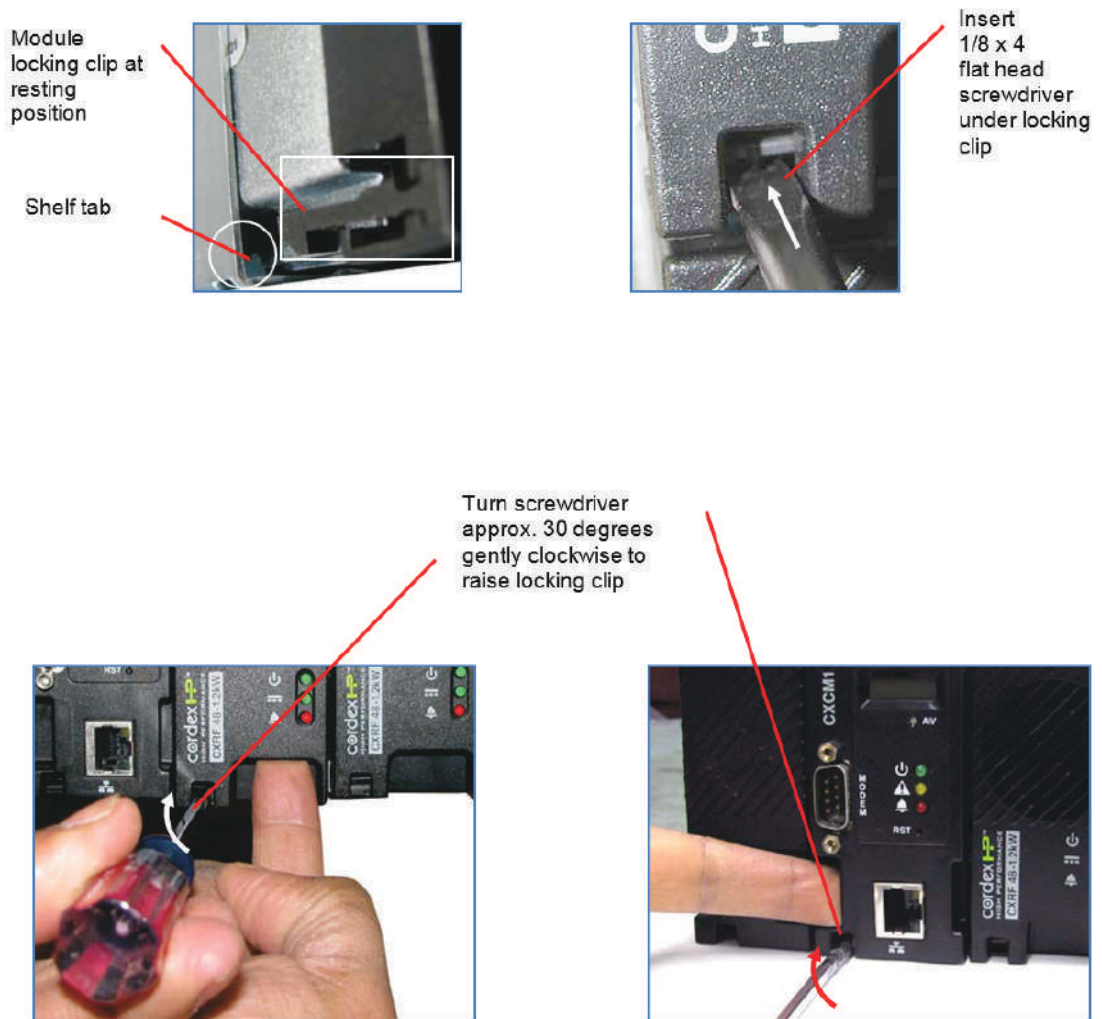

5.6 Removing the CXCM1 HP

To remove the CXCM1 HP:

1. Push up and hold the latch while removing the controller.
2. Pull from the location noted in the following image to remove the controller.

CAUTION: When removing the controller in a live system that has an LVD, ensure that the LVD override jumper is set to correct position to avoid possible service disruption. Refer to the wiring and connections section of the manual and the connection drawings

Figure 16: Removing the CXCM1 HP

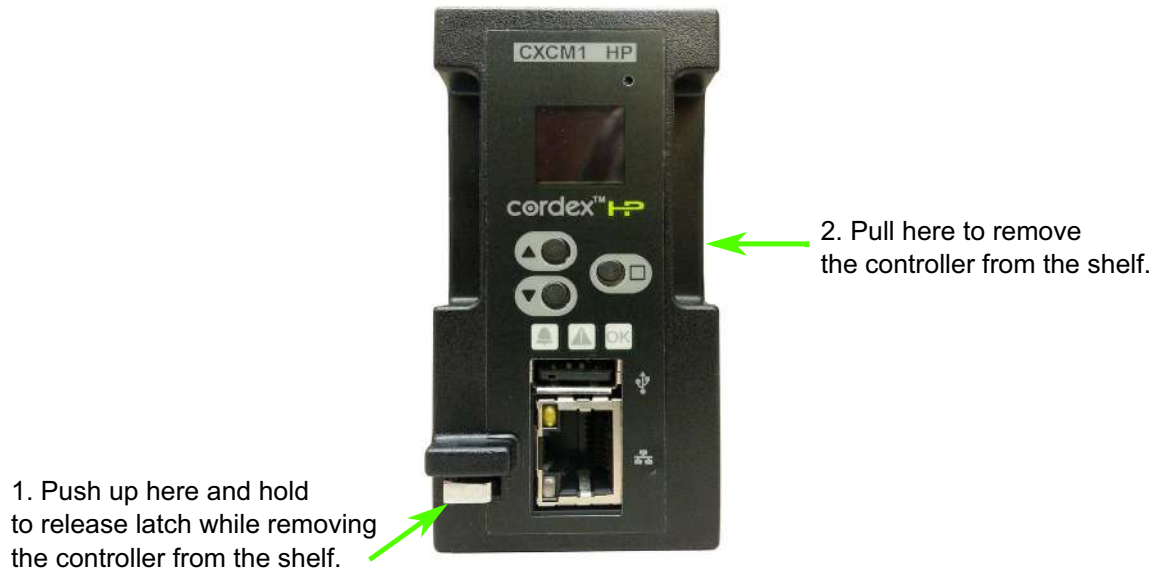

6 Wiring and Connections

This chapter provides cabling details and notes on cable sizing for DC applications with respect to the shelf.

NOTE: Refer to the drawings located at the rear of the manual.

6.1 Safety Precautions

WARNING: Hazardous AC voltages may be present. Ensure power at the AC service panel is off before attempting work on the AC connections. Use a voltmeter to verify the absence of voltage. Clearly mark the correct polarity of the battery leads before commencing work on DC connections.

Refer to the chapter on Installation for additional safety precautions.

6.2 Tools Required

Various tools are essential for product installation. Insulated tools are recommended. Use this list as a guide:

- Slot head screwdrivers (blade sizes: 1/4", 1/8", 1/16")
- Phillips head screwdriver, #2 (tip size 3/16")
- Digital voltmeter equipped with test leads
- Adjustable 24/48Vdc load (optional)
- Cutters and wire strippers
- Crimping tool (optional for large gauge wire)
- Socket and ratchet set (Imperial measure)
- Anti-static wrist strap
- Computer (laptop) with web browser
- Standard network cable (for access using the Ethernet port)

6.3 AC Feeder Protection/Sizing

To maximize system reliability, the AC feed divides the rectifiers into groups to be supplied by separate feeds. See customer connections drawing (modules are numbered left to right).

- 0300165: TBA-1 feeds modules 1 and 2. TBA-2 feeds modules 3 and 4.
- 030-835-20: TBA-1 feeds modules 1 and 2. TBA-2 feeds modules 3 and 4.
- 030-845-20: TBA-1 feeds module 1. TBA-2 feeds modules 2 and 3. TBA-3 feeds modules 4 and 5.
- 030-851-20: TBA-1 feeds modules 1 and 2. TBA-2 feeds module 3.

It is recommended, for each feed, to use a dedicated protection feeder breaker located at the AC distribution panel. The feeder breaker can also act as the disconnect device for the connected modules.

Table 2: Recommended AC Supply Configuration

AC Input (Vac)	Number of Rectifiers on AC Feed	Circuit Breaker, Exact Value to Use (A)
120/240	1	15
120	2	15
208/220/240	2	20

An external surge protection device is not required. The rectifiers are protected by internal MOVs.

6.4 AC Input

CAUTION: Route the AC input wires in flexible or rigid conduit as far away as possible from the DC power wires to minimize EMI disturbances.

All shelf systems have male IEC-60320-C20 ISA line cord connection points for pluggable line cords with C19R female receptacles.

Refer to customer connection drawings at the rear of this manual.

NOTE: The shelf incorporates IEC plug connections requiring line cords with C19R type receptacles.

Figure 17: AC input, CAN, and signal connections (4800W system)

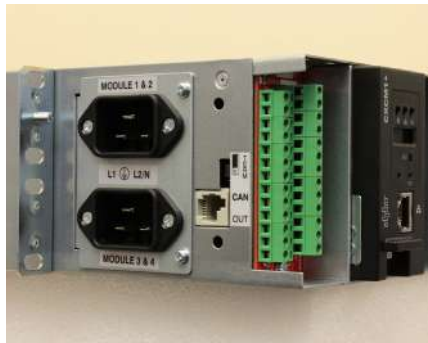

6.4.1 Strain Relief

Cable strain relief for AC cords ship loose in the box with the rectifier shelf.

Push the barbed end of the strain relief into a square hole on the back of the shelf, and then secure the cable with the twist tie.

Figure 18: AC Cord Strain Relief for IRU Shelves



6.5 Calculating Output Wire Size Requirements

Wire size is calculated by first determining the appropriate maximum voltage drop requirement. Using the formula below calculate the CMA wire size requirement. Determine the size and number of conductors required to satisfy the CMA requirement.

$CMA = (A \times LF \times K) / AVD$, where:

- CMA: Cross section of wire in circular MIL area
- A: Ultimate drain in amps
- LF: Conductor loop feet
- K: 11.1 constant factor for commercial (TW type) copper wire
- AVD: Allowable voltage drop

Check again that the ampacity rating of the cable meets the requirement for the installation application. Consult local electrical codes (NEC, CEC, etc.) for guidelines. If required, increase the size of the cable to meet the code.

6.6 DC Output

6.6.1 DC Output for Model 030-851-20 (maximum 3600W)

Chassis and Site Ground Connections

WARNING: For safety reasons, ensure the system is properly bonded to the building's ground grid.

NOTE: This power system is suitable for installation as part of a Common Bonding Network (CBN) and is intended to be used in a DC-C configuration (common DC return). In this configuration, both the shelf chassis ground (via power system chassis ground) and common return shall be connected to the building master ground bus (MGB) or floor ground bus (FGB), in a larger building, to ensure correct operation of the system and to prevent drifting floating analog (especially current) readings.

The chassis is connected to the MGB via mounting brackets.

DC Output to Loads

DC output connections are made at the distribution module at the front of the shelf.

Figure 19: DC Output Connections

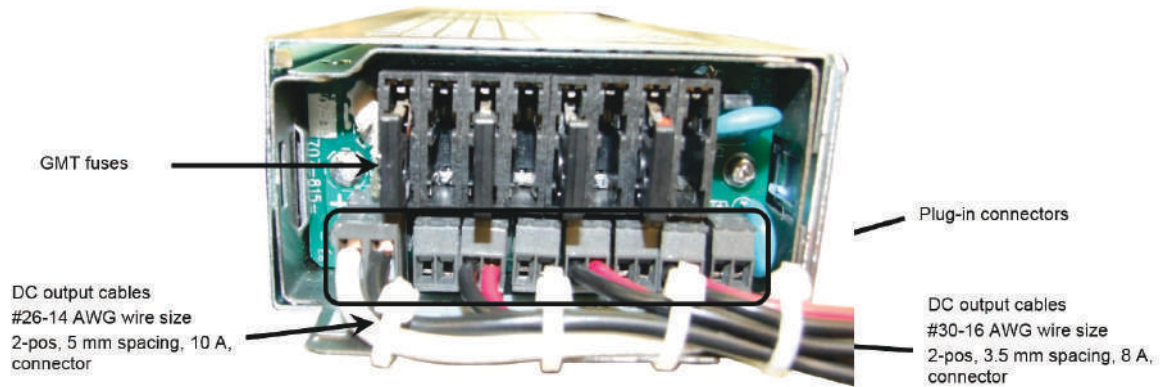

NOTE: Make sure the applicable fuse has been removed before unplugging the corresponding connector.

1. To connect a DC output cable, use needle nose pliers to pull out the appropriate plug-in connector. Apply gentle clamping force to the pliers to avoid breaking the connector.



2. After the plug-in connector has been removed, attach the cables to the terminal block. Verify the polarity.



Attach cables to plug-in connector

3. Insert the terminal block together with attached cables. Use tie wraps to secure the cables.



4. Insert fuses into the slots.

The maximum allowable output current of the GMT block is 40A distributed over up to eight poles. The bigger left pole can accommodate a current of up to 10A with a fuse of up to 15A. The smaller poles can each accommodate a current of up to 8A with a fuse of up to 10A.

NOTE: When using the bigger left pole with a 15A fuse, always leave the adjacent position empty.

DC Output to Batteries

The wires must be UL approved XHHW or RHH/RHW (for Canadian users, RW90 Type). Double check the battery polarity and then connect the positive cable to the top side of the output bar and negative cable to bottom side.

Figure 20: DC Output to Batteries

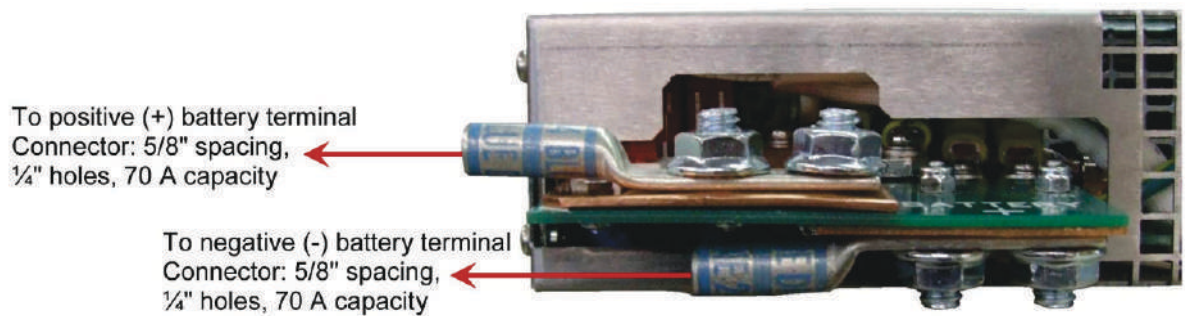

6.6.2 DC Output for Model 0300165 (maximum 4800W)

The DC cable connections to the system are made within, or just outside, the integrated distribution module located on the right side of the shelf. To ensure proper access to connections, install DC cables in the sequence described in this section.

WARNING: Leave cables disconnected at battery and verify output polarity using a voltmeter. Make battery connections only after all other wiring is completed.

DC output wire shall be UL approved XHHW or RHH/RHW (Type RW90 for Canada)

Figure 21: DC Output Connections (Four Load Breaker Configuration shown)

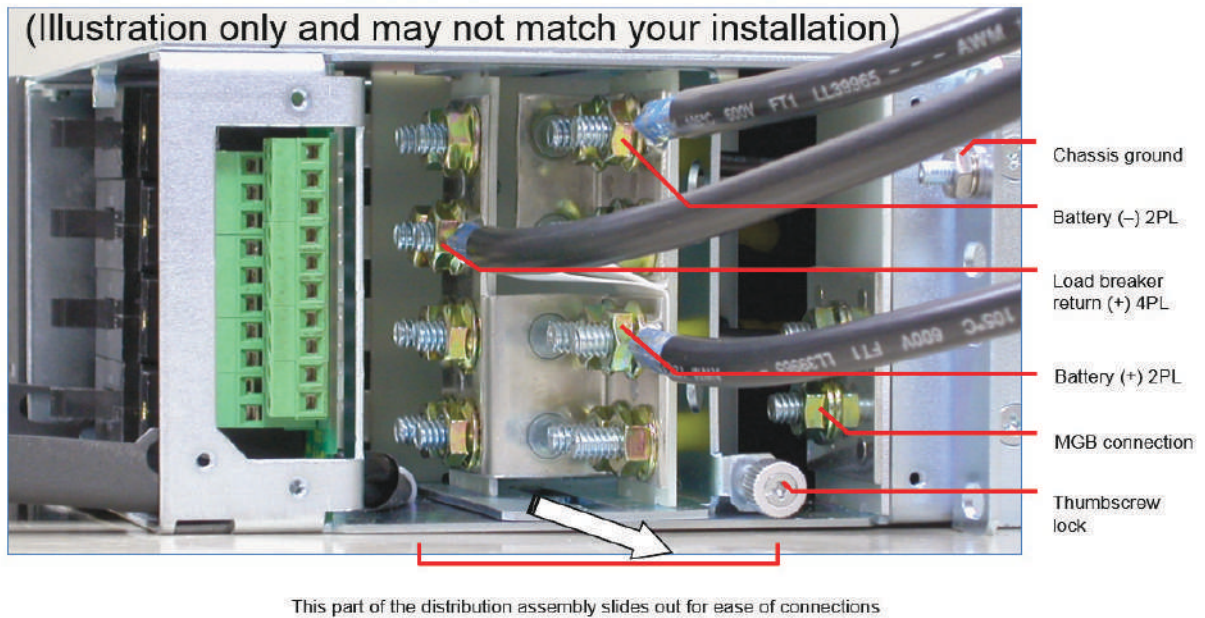

NOTE: Cabling must be done with enough slack to allow the distribution assembly to be locked into place.

Chassis and Site Ground Connections

WARNING: For safety reasons, ensure the system is properly bonded to the building's ground grid.

This power system is suitable for installation as part of a Common Bonding Network (CBN), and is intended to be used in a DC-C configuration (common DC return). In this configuration, both the shelf chassis ground (via power system chassis ground) and common return shall be connected to the building master ground bus (MGB) or floor ground bus (FGB), in a larger building, to ensure correct operation of the system and to prevent drifting floating analog (especially current) readings.

The chassis ground connection is located on the center mount rack bracket. Connect to the #10-32 stud using single-hole lug and hardware as provided.

The system MGB connection is located within the distribution module to the left of the chassis ground location. The two studs are oriented at a 45-degree angle, which requires a 1/4" on 5/8" center lug.

Battery Connections

There are connection points for two strings of batteries. Use the thumbscrew lock to disengage part of the distribution assembly and slide it out the right side of the shelf as far as necessary.

Connect the battery (+) cabling to the bottom set of studs and the battery (-) cabling to the upper set. Lugs required are 1/4" on 5/8" centers.

Breaker Return Connections

The load breaker returns (+) for each of the four breakers are also found on the same part of the (sliding) distribution assembly.

Connect to the breaker (ground) returns using 1/4" on 5/8" center lugs.

Slide the connection point assembly back into the distribution module and secure with the thumbscrew lock. Note the cable(s) and the connection points positioned for proper access.

Figure 22: Breaker Return Connections (Four Load Breaker Configuration shown)

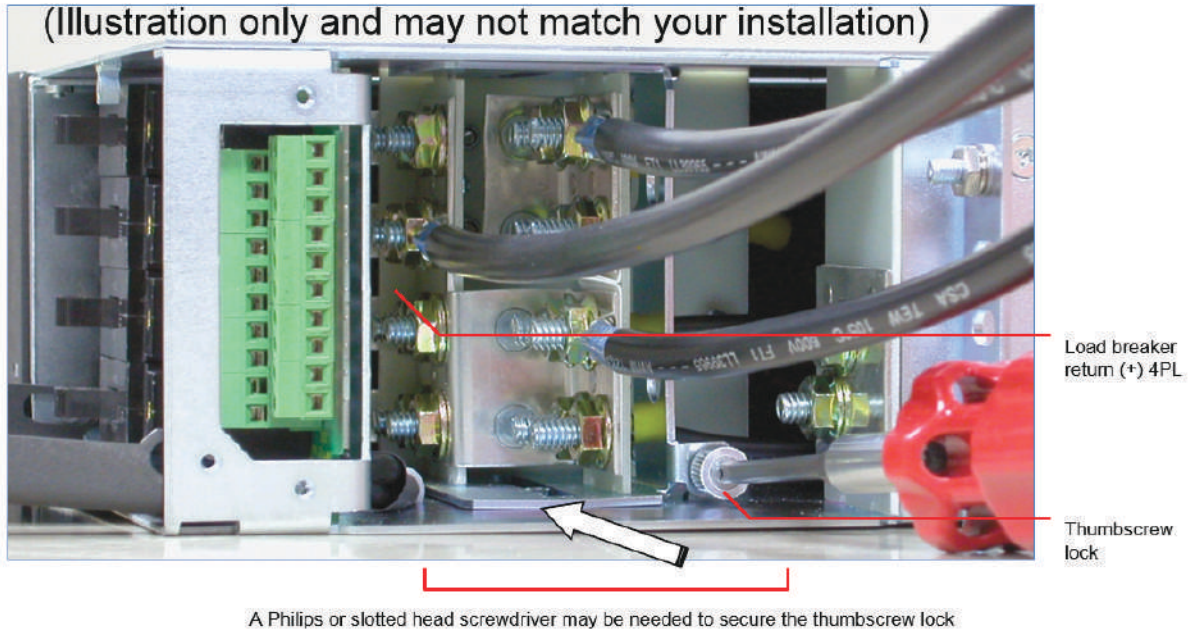

Breaker Hot Connections

Connect to the four load breaker hot (-) termination pairs using 1/4" on 5/8" center lugs. Connection method is similar for breaker distributions in a 2 load/2 battery CB configuration. Refer to the connection drawing.

Figure 23: Front View of Distribution Module (Four Load Breaker Configuration shown)

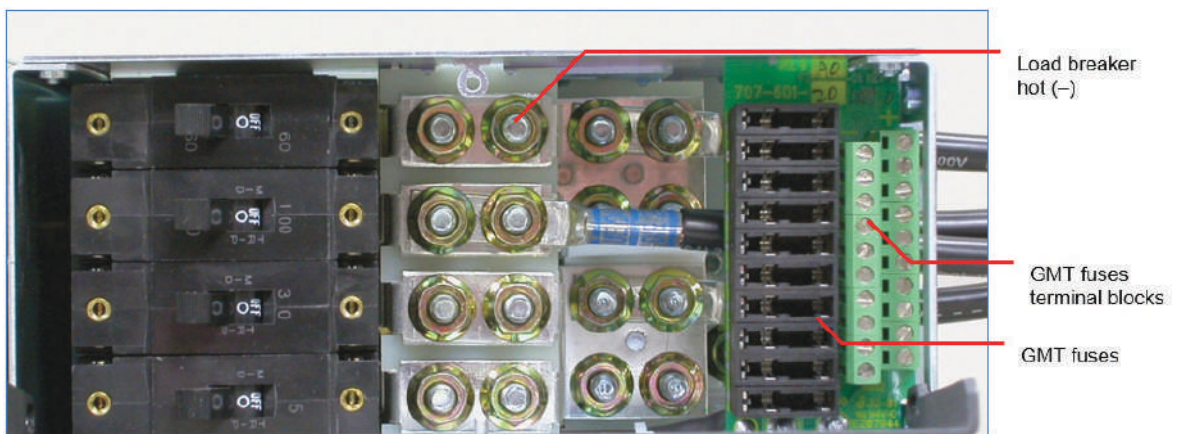

GMT Fuse Distribution

The ten (10) GMT-style fuses and the associated terminal blocks are accessible from the front panel of the distribution module (Refer to the connection drawing).

Connect via screw terminations, hot (–) and return (+), for each fuse position.

The maximum allowable output current of the GMT box is 30A distributed over some or all of the ten GMT fuse positions. The largest current that can be accommodated is 10A with a fuse of up to 15A.

If using a 15 A fuse, leave the adjacent fuse position(s) empty.

6.6.3 DC Output for Model 030-835-20/ 030-845-20 (bulk distribution)

Models 030-835-20 and 030-845-20 have no integrated distribution. Output connections are made using 1/4" on 5/8" center 2-hole lugs that connect to the main output bars similar to the 030-851-20 battery terminations.

6.7 CAN Ports

The 3 and 4-module shelf, 1RU model with CXCM1+ or CXCM1 HP, has a single CAN port for communications with CAN-enabled equipment (nodes). It is located on the side of the shelf. The 5-module shelf has two ports, located on the rear. The 2RU shelf has one port on the side.

Daisy-chain from node to node (CAN OUT of one node to CAN IN of another) as necessary and ensure that only the last node is terminated.

- 4-module shelf – termination IN – default
- 5-module shelf – termination OUT – default

NOTE: This system has a limit of twelve Cordex 1.2kW rectifiers; due to available power from CAN Bus. They do not have self-powered CAN Bus nodes.

6.8 Network Connection and Remote Communications via the Controller

Alpha's Cordex rectifier shelf systems can be set up, monitored and tested via modem or Ethernet 10/100 Base-T serial data connection. The communication protocol supports a web interface. Some standard scenarios are described in the following sections.

6.8.1 Ethernet Port for Network Connection

The Ethernet port is designed for controller connection to a user supplied network (TCP/IP secured by user) via a front panel RJ-45 jack.

Connect to the controller using a standard network cable. Pinouts are shown in the connection drawings.

6.8.2 Ethernet Port for Local Connection

Local access (e.g. laptop computer) is also possible from the Ethernet port connection using a standard network cable.

NOTE: Older CXCM1+ models must use a crossover Ethernet cable for direct connection to a computer.

6.9 Signal Wiring Connections

For terminal block connections, the recommended wire sizes are #16 to #26 AWG (1.5 to 0.129mm²). Control and sense wires shall be UL approved Style 1015 (for Canadian users, TEW type).

CAUTION: To reduce the risk of fire, use only #26 AWG (0.129mm²) or thicker wire.

Bundle the signal cables together and route them through the entry holes of the shelf.

Figure 24: Signal Wiring Terminal Blocks (030-851-20 shown)

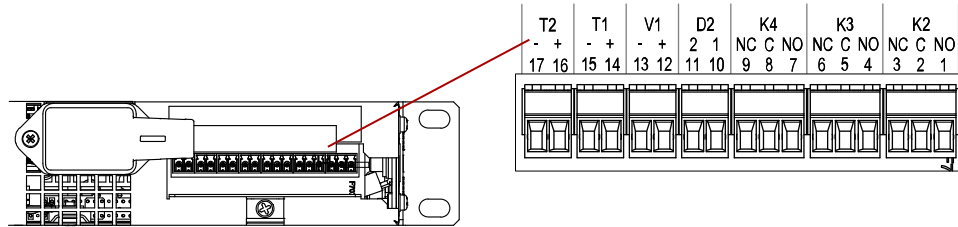

6.9.1 Analog Inputs

CAUTION: Ensure the correct polarity is used for all input cable terminations.

Ensure the correct polarity is used for all input cable terminations. The analog input channels are used to monitor various types of electrical signals. The Voltage Input is -60 to +60Vdc. The Temperature Input (designed for Alpha supplied temp sensor only) is 0 to 5Vdc with power source.

Voltage

Voltage Input #1 (V1) terminals on the shelf provide connections to an optional secondary voltage input. Voltage Input #2 (V2) is wired internally to the rectifier output voltage of the shelf. This is used as the reference for Voltage regulation of rectifiers, system alarming (such as high voltage) and control (such as LVD).

See the software manual for information on configuring Alarms and LVD control. The Battery -48V should be connected at the battery system voltage terminal, if applicable, for redundant power feed to the CXCM1 series controller when a battery disconnect device is used. It is critical to controller operation as it ensures an auxiliary source of power to the controller should the disconnect device open the circuit.

Current

Current input #1 (I1) is wired internally to the system current shunt.

Temperature Sensor

Temperature Probe input channels (T1, T2) provide connections for up to two temperature sensors. A voltage is supplied to these terminals for sensor measurements. Temperature sensors are available from Alpha in various lengths.

6.9.2 Digital Inputs

The digital input channels (D1, D2) are used to monitor various alarm and control signals. All input channels are voltage activated and accept a bipolar (i.e. negative or positive) DC signal directly.

For shelf modules with integrated distribution, D1 is wired internally for CB/fuse trip. D2 is available for customer connections as required.

Connection Method

Typical Alpha systems use the “reset with Hot and trigger with Ground” connection. The digital input is wired in such a way that the Hot is wired directly into one of the input terminals; e.g., negative input for -48V systems. The other input terminal is wired to the Ground (common) of the system through a relay

(dry contact – usually located on the equipment requiring monitoring). This method allows the digital input to receive (or not receive) a Ground signal on an alarm.

Figure 25: Digital Input Connection Method

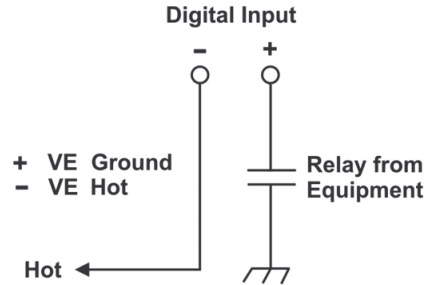

Programming the Digital Input

The digital input channels can be programmed for “active high” or “active low. Active high indicates, “alarm on the presence of a ground signal” and active low indicates, “alarm on the removal of a ground signal.” See controller software manual for detailed instruction on programming.

Table 3: Voltage Level Definitions for Digital Inputs

Voltage Range (Vdc)	Voltage Level (Vdc) Considered As “0” (Off)	Voltage Level (Vdc) Considered As “1” (On)
0-60 (System Voltage Setting)	-1.5 to 1.5V	-60 to -5V or +5 to +60V

NOTE: Between 1.5 to 5V is an undefined operation.

6.9.3 Alarm (Relay) Outputs

Terminals provide contacts for extending various alarm or control signals. Each relay output (K2, K3, K4) can be wired for NO or NC operation during an alarm or control condition.

Figure 26: Relay Connections

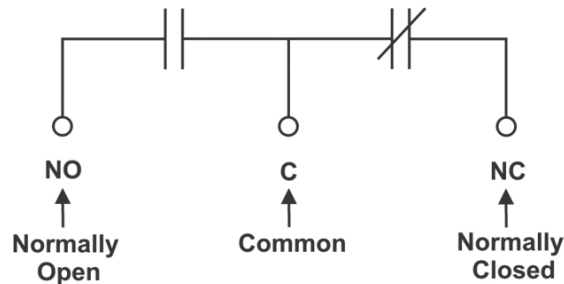

Relays can be programmed to energize or de-energize during an alarm condition (see controller software manual). When the CXCM1 reset button is pressed or power is lost, all relays de-energize.

These relays could be used for additional external LVD contactor control; however, this would not provide the redundant LVD control as with the assigned output pins described below.

6.9.4 LVD Control (Load Disconnect or Battery Disconnect)

The disconnect option is controlled by and connected internally to relay K1.

LVD Inhibit

Should it be necessary to remove a CXCM1 series controller, the customer connection board (on the front of the shelf) provides shorting pins (JP2) to inhibit (or override) the LVD Control function. See the customer connections drawings.

If the LVD is controlled on NC contacts (factory default for LVD option), then JP2 pins 1 and 2 must be shorted together to maintain LVD operation. If the LVD is controlled on NO contacts, then pins 2 and 3 must be shorted together. For normal operation, the factory-supplied shorting jumper should be left on pins 3 and 4.

6.9.5 LVD Control Alternative

The LVD Control functions can be hardwired directly from an alarm output relay to an external LVD contactor (or panel). See Controls Menu Defaults in the controller software manual.

7 Operation

7.1 Main Rectifier States

Rectifier operation has five main states; each state is distinct and necessary for the operation of the rectifier.

- Off
- Start Delay
- Soft Start
- Normal Operation
- Turning Off

7.1.1 Off

The rectifier is in the Off state immediately after power is applied to the rectifier or after a rectifier shutdown (remote or local shutdown, AC shutdown, OVP or thermal shutdown).

In this state the DC-DC converter is turned off and the controller monitors its inputs for the proper conditions to begin the start up sequence.

When the conditions have been met for the rectifier to start up, it transitions to the Start Delay state.

7.1.2 Start Delay

When the rectifier is in the Start Delay state, the DC-DC converter is held off and still not sourcing power, waiting for a given amount of time before transitioning to the next state.

The controller continues to monitor its inputs.

After the Start Delay state the rectifier transitions to the Soft Start state.

NOTE: Soft start, or current walk-in, gradually increases the voltage and current output of the rectifier upon startup. This is done to reduce the instantaneous load on the AC source.

7.1.3 Soft Start

When the Soft Start state is entered, the rectifier is turned on and the output voltage and output current gradually increased. If a load is present, the rectifier begins to source power.

When the voltage and current limit ramps have finished, the rectifier will transition to the Normal Operation state.

7.1.4 Normal Operation

The Normal Operation state is the state that the rectifier will be in performing all of the rectifier functions and features specified herein.

From this state, the only valid transition is to the Turning Off state. This transition will happen if the rectifier is required to shut down.

7.1.5 Turning Off

The Turning Off state is entered because a short delay is required before the rectifier actually turns off to take care of any initialization requirements.

When this short delay has elapsed, a transition to the Off state is made.

7.2 Main Rectifier Modes

In addition to main rectifier states, there is a set of main rectifier modes. These modes are divided into two categories:

7.2.1 Output Voltage Modes

Voltage modes, under software control, can directly adjust the output voltage. Situations, such as the rectifier being in current limit, can change the output voltage with no software control.

The following table describes the five output voltage modes.

Table 4: Output Voltage Modes

Output Voltage Modes	Active when...
Float	Output voltage is set to the float voltage setting.
Equalize	Output voltage is set to the equalize voltage setting.
Battery Test	Output voltage is set to the battery test voltage setting.
Safe	Output voltage is set to the safe mode voltage setting.
Manual Test	Output voltage can be manually adjusted outside of the standard adjustment ranges.

7.2.2 Output Current/Power Modes

These four output current/power modes directly affect the output current and power:

Table 5: Output Current/Power Modes (Sheet 1 of 2)

Output Current/Power Mode	Output current and power limit have been reduced due to:
Temperature foldback mode	High temperature of the heatsink or internal ambient temperature sensor.
AC foldback mode	Low AC input voltage. <i>NOTE: Reduces the risk of tripping an AC breaker due to increased AC current draw as the AC voltage decreases.</i>

Table 5: Output Current/Power Modes (Continued) (Sheet 2 of 2)

Output Current/Power Mode	Output current and power limit have been reduced due to:
Short circuit foldback mode	Short circuit at the output.
Internal fault foldback mode	Internal fault.

7.3 CAN Bus Communication

The CAN bus is used for commands and data transfer between the rectifier and controller to configure the rectifier with system settings and to monitor rectifier status.

7.4 Factory Ranges and Defaults

The following table lists the rectifier settings/ranges/defaults; changes are made from the controller:

Table 6: Factory Ranges and Defaults (Sheet 1 of 2)

Setting	Range (minimum to maximum)	Default
Float (FL) Voltage	48 – 58V	54V
Equalize (EQ) Voltage	50 – 58V	55V
Battery Test (BT) Voltage	44 – 52V	46V
Over Voltage Protection (OVP)	See note below – 59V	57V
Current Limit (CL)	23 – 100%	100%
Power Limit (PL)	0 – 100%	100%
Module Start Delay	0 – 250s	1s
System Start Delay	0 – 600s	0s
Low Voltage Alarm (LVA)	42 – 52V	44V
High Voltage Alarm (HVA)	52 – 59V	55.5V
Equalization (EQ) Timeout	1 – 2399h	30h
Battery Test (BT) Timeout	1 – 250h	8h
Softstart Ramp-rate	Normal/Fast	Normal

Table 6: Factory Ranges and Defaults (Continued) (Sheet 2 of 2)

Setting	Range (minimum to maximum)	Default
Current Limit / Power Limit Alarm	Enable/Disable	Enable
Remote Shutdown	Enable/Disable	Enable
Ramp Test	Enable/Disable	Enable

NOTE: OVP cannot be set below the present system/FL/EQ/BT voltage setting or the safe mode voltage of 51.4V.

8 System Startup

8.1 Check System Connections

- Ensure AC is off, battery is disconnected, and all power modules are removed from the shelf.
- Verify the polarity of all connections.

8.2 Verify AC and Power The Shelf

- Install one power module.
- Verify AC input voltage is correct and turn on the corresponding AC input feeder breaker.
- The power module OK LED should illuminate after a preset start delay.
- Using the controller, test functionality of various module alarms and controls.

8.3 Check Battery Polarity and Connect

- Verify correct battery polarity using a voltmeter (ensuring no cells or batteries are reversed).
- Connect battery as required to the output of the system or turn on battery breaker.
- Install remaining power modules.
- On the controller, set Float and Equalize voltage to the levels specified by the battery manufacturer.
- For some systems, the default setting for low AC voltage alarming is 180Vac. For nominal 120Vac operation, it is recommended to reset this value to 100Vac.
- Using the controller, test the functionality of various module alarms and controls. In addition, perform a load test with the system using a resistive load box as needed.

8.4 Controller Reset

8.4.1 Soft Reset (CXCM1+ only)

The reset button located on the front panel of the CXCM1+ is for restarting the microprocessor. When pressed momentarily, the unit beeps twice then resets. The front-panel LEDs illuminate temporarily, and then extinguish after the system has finished its 15-second self-test.

NOTE: This does not apply to the CXCM1 HP.

8.4.2 IP Address Reset (CXCM1+ only)

To reset the IP address, press and hold the front panel reset button for three seconds. The CXCM1+ unit beeps three times, IP address resets to 10.10.10.201 and DHCP is disabled. The settings are saved and the unit then resets.

This reset allows local access; e.g., with a laptop and a standard network crossover cable. See current version software manual for details.

NOTE: This does not apply to the CXCM1 HP.

8.4.3 Hard Reset

A hard reset of the controller can be performed by unplugging the module. This procedure will restart the microprocessor if the front panel (soft) reset button fails to operate.

CAUTION: Move the LVD control jumper to the override position before unplugging the controller. The load and batteries are still connected. Use of hard reset may cause loss of data.

8.5 Accessing the LVD Jumper

To change the LVD control jumper position:

1. Remove the GMT fuse cover by gently squeezing the sides of the cover. The cover will unlatch and pop off.



2. Use pliers to gently move the LVD control jumper from the auto position to the override position.

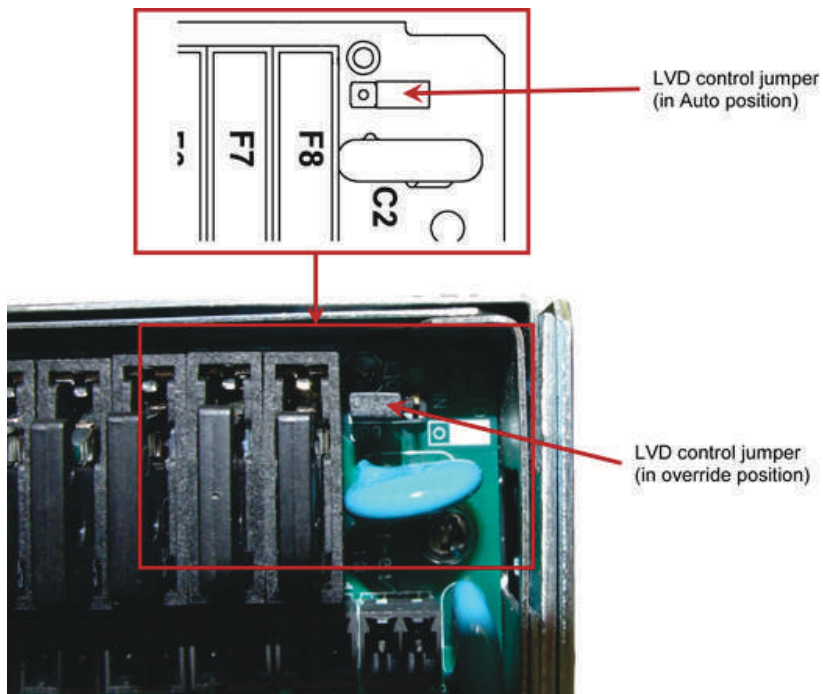

9 Maintenance

Although very little maintenance is required with Alpha systems, routine checks and adjustments are recommended to ensure optimum system performance. Qualified service personnel should do repairs.

The following table lists a few maintenance procedures for this system. These procedures should be performed at least once a year.

In areas where flying insects and other debris may routinely clog the rectifier fan filter, it may be necessary to inspect ventilation openings and replace the rectifier fan filter (if applicable) more often.

WARNING: HIGH VOLTAGE AND SHOCK HAZARD.

Use extreme care when working inside the shelf while the system is energized. Do not make contact with live components or parts.

IMPORTANT: Circuit cards can be damaged by static electricity. Always wear a grounded wrist strap when handling or installing circuit cards.

Table 7: Sample Maintenance Log

Procedure	Date Completed
Clean ventilation openings (replace rectifier fan filter if applicable)	
Inspect all system connections (re-torque as necessary)	
Verify alarm/control settings	
Verify alarm relay operation	

9.1 Rectifier Fan Replacement

Rectifier modules can be removed and re-inserted with the power on.

The fan replacement kit part number is 010-619-G0-000.

Figure 27: Rectifier Fan Replacement

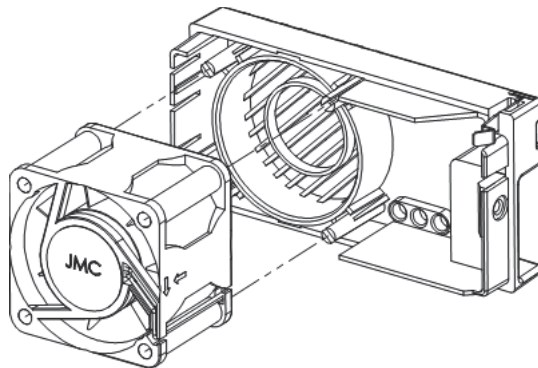

NOTE: This procedure takes about 5 minutes to complete.

-
1. Slide the module 10 cm (4") out of the shelf and wait two minutes for module capacitors to discharge.
 2. Remove the bottom screw that secures the front panel to the module chassis
 3. Slide the front panel out.
 4. Disconnect the fan power lead wires from the module.
 5. Note the direction of airflow and remove the fan from the front panel.
 6. Install the replacement fan following the preceding steps in reverse order.
-

10 Warranty and Service Information

10.1 Technical Support

Tel: +49 9122 79889 0

Mail: info@alpha-outback-energy.com

10.2 Warranty Statement

For full warranty information, please contact us:

Tel: +49 9122 79889 0

Mail: info@alpha-outback-energy.com

10.3 Product Warranty

AOE warrants that for a period of two (2) years from the date of shipment its products shall be free from defects under normal authorized use consistent with the product specifications and Alpha's instructions, the terms of the manual will take precedence. The warranty provides for repairing, replacing or issuing credit (at AOE's discretion) for any equipment manufactured by it and returned by the customer to the factory or other authorized location during the warranty period. There are limitations to this warranty coverage. The warranty does not provide to the customer or other parties any remedies other than the above. It does not provide coverage for any loss of profits, loss of use, costs for removal or installation of defective equipment, damages or consequential damages based upon equipment failure during or after the warranty period. No other obligations are expressed or implied. Warranty also does not cover damage or equipment failure due to cause(s) external to the unit including, but not limited to, environmental conditions, water damage, power surges or any other external influence. The customer is responsible for all shipping and handling charges. Where products are covered under warranty AOE will pay the cost of shipping the repaired or replacement unit back to the customer.

10.4 Battery Warranty

Note that battery warranty terms and conditions vary by battery and by intended use. Contact your AOE sales representative or the Technical Support team at the above number to understand your entitlements under Battery Warranty.

10.5 Warranty Claims

Any claim under this Limited Warranty must be made in writing to AOE BEFORE sending material back. AOE will provide Product return instructions upon approval of return request. A Service Repair Order (SRO) and / or Return Authorization (RA) number will be issued ensuring that your service needs are handled promptly and efficiently. Claims must be made online at: www.alpha-outback-energy.com

10.6 Service Information

For more information visit: www.alpha-outback-energy.com

11 Certification

CSA (Canadian Standards Association also known as CSA International) was established in 1919 as an independent testing laboratory in Canada. CSA received its recognition as an NRTL (Nationally Recognized Testing Laboratory) in 1992 from OSHA (Occupational Safety and Health Administration) in the United States of America (Docket No. NRTL-2-92). This was expanded and renewed in 1997, 1999, and 2001. The specific notifications were posted on OSHA's official website as follows:

- Federal Register #: 59:40602 - 40609 [08/09/1994]
- Federal Register #: 64:60240 - 60241 [11/04/1999]
- Federal Register #: 66:35271 - 35278 [07/03/2001]

When these marks appear with the indicator “C and US” or “NRTL/C” it means that the product is certified for both the US and Canadian markets, to the applicable US and Canadian standards. (1)

Alpha rectifier and power system products, bearing the aforementioned CSA marks, are certified to CSA C22.2 No. 60950-01 and UL 60950-1. Alpha UPS products, bearing the aforementioned CSA marks, are certified to CSA C22.2 No. 107.3 and UL 1778. As part of the reciprocal, US/Canada agreement regarding testing laboratories, the Standards Council of Canada (Canada's national accreditation body) granted Underwriters Laboratories (UL) authority to certify products for sale in Canada. (2) Only Underwriters Laboratories may grant a license for the use of this mark, which indicates compliance with both Canadian and US requirements.(3)

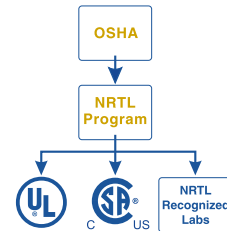

NRTL's Capabilities

NRTLs are third party organizations recognized by OSHA, US Department of Labor, under the NRTL program. The testing and certifications are based on product safety standards developed by US based standards developing organizations and are often issued by the American National Standards Institute (ANSI). (4) The NRTL determines that a product meets the requirements of an appropriate consensus-based product safety standard either by successfully testing the product itself, or by verifying that a contract laboratory has done so, and the NRTL certifies that the product meets the requirements of the product safety standard. (4)

Governance of NRTL

The NRTL Program is both national and international in scope with foreign labs permitted.

(1) www.csagroup.org

(2) www.scc.ca

(3) www.ulc.ca

(4) www.osha.gov

12 Glossary

AC	Alternating Current
ACCT	Alternating Current Current Transducer
ADIO	Analog-digital input-output
ALCO	Alarm cutoff
CAN	Controller Area Network
CT	Current Transducer
CX	Cordex series; e.g. CXC for Cordex™ System Controller
CXC	Cordex™ Controller
CXC HP	Cordex™ Controller High Performance
CXD	Cordex™ DC-DC Converter
CXR	Cordex™ Rectifier
DC	Direct current
DCCT	Direct Current Current Transducer
DHCP	Dynamic Host Configuration Protocol
DOD	Depth of discharge
FCC	Federal Communications Commission
GUI	Graphical User Interface
ICMP	Internet control message protocol
IEC	International Electrotechnical Commission
IETF	Internet Engineering Task Force
IP	Internet Protocol

IPv4	Internet Protocol version 4
IPv6	Internet Protocol version 6
ISO	International Organization for Standardization
LCD	Liquid Crystal Display
LED	Light Emitting Diode
LVD	Low voltage disconnect
LVBD	Low voltage battery disconnect
MAC	Media Access Control; e.g. MAC address
MIB	Management Information Base; a database of entities most often associated with SNMP
MOV	Metal Oxide Varistor
MUX	Multiplexer
NEBS	Network Equipment-Building System; a set of safety, spatial and environmental guidelines for telecom
OLED	Organic LED, in-shelf controller display
RFC	Request For Comments; a formal document (or standard) from the Internet Engineering Task Force (IETF)
SCI	Serial Communication Interface
SELV	Safety Extra Low Voltage
SMTP	Simple Mail Transfer Protocol
SNMP	Simple Network Management Protocol
SNTP	Simple Network Time Protocol
SOC	State of Charge
TCP/IP	Transmission Control Protocol / Internet Protocol
Trap	An unsolicited SNMP event notification

13 Specifications

13.1 Cordex HP 48 1.2kW Switched Mode Rectifier

Table 8: Specifications: Cordex HP 48 1.2kW, Switched Mode Rectifier (Sheet 1 of 3)

Specifications: Cordex HP 48-1.2kW, Switched Mode Rectifier	
Power Module Output	
Voltage:	42 to 58Vdc within rated limits
Power:	1200W (176 to 300Vac input) 600W minimum (110 to 130Vac input) [Subject to de-rating below 110Vac due to current limited input and when operated above temperature thresholds listed below]
Current:	22.2A @ 54Vdc, 25A maximum @ 48Vdc (176 to 300Vac input) 11.1A @ 54Vdc, 12.5A maximum @ 48Vdc (110 to 130Vac input)
Static Load Regulation:	Better than $\pm 0.5\%$ for any load change within rated limits
Static Line Regulation:	Better than $\pm 0.1\%$ for any change in input voltage within rated limits
Dynamic Line Regulation:	Better than $\pm 1\%$ for any change in input voltage within rated limits (output voltage shall recover to static limits within 2ms)
Hold up Time:	>10ms
Time Stability:	$\leq 0.2\%$ per year
Temperature Stability:	$\leq 100\text{ppm}/^\circ\text{C}$ over the operating range
Heat Dissipation:	<308 BTU per hour (per rectifier module)
Electrical Noise:	<38dBnC (voice band) <30mVrms 10kHz to 10MHz (wide band) <150mVp-p 10kHz to 100MHz <2mV (psophometric)
Acoustic Noise:	<60dBa @ 1m (3ft.) @ 30°C (86°F)
EMI:	The unit meets requirements of EN55022: Class A for Radiated Emissions, and Class B for Conducted Emissions (see Standards for more EMC)
In accordance with FCC requirements, we provide the following statement as specified in the FCC guidelines for conformance to Part 15, Class A:	

Table 8: Specifications: Cordex HP 48 1.2kW, Switched Mode Rectifier (Continued) (Sheet 2 of 3)

Specifications: Cordex HP 48-1.2kW, Switched Mode Rectifier	
<p><i>NOTE: This equipment has been tested and found to comply with the limits for a Class A digital device, pursuant to part 15 of the FCC Rules. These limits are designed to provide reasonable protection against harmful interference when the equipment is operated in a commercial environment. This equipment generates, uses, and can radiate radio frequency energy and, if not installed and used in accordance with the instruction manual, may cause harmful interference to radio communications. Operation of this equipment in a residential area is likely to cause harmful interference in which case the user will be required to correct the interference at his own expense.</i></p>	
<p>Any changes or modifications to this equipment not expressly described in this manual could void the FCC compliance.</p>	
Power Module Input	
Voltage:	208/220/240Vac (continuous operation 90-300Vac) High: 277 to 300Vac (de-rated power factor) Low: 90 to 176Vac (de-rated output power)
Frequency:	50/60Hz nominal (45 to 66Hz)
Current:	7.5A maximum (176 to 300Vac) 6A maximum (90 to 176Vac)
Power Factor:	>0.99 at nominal conditions and 50-100% load
Protection:	10kA-interrupting capacity fuses in active and neutral lines
Efficiency:	>94% peak; 93.5% at nominal conditions and 50-100% load
Inrush current:	≤ full load steady state current of the rectifier within rated limits
Start-up Ready Time:	<5 seconds (excluding soft start) to complete inrush limit routine and ac measurement (for OK signal)
Start-up Delay:	Programmable up to 120 seconds to enable stagger-start of multiple rectifiers and to minimize the effect on a supply source
Soft Start:	User adjustable to at least 5 seconds (not including start-up delay time) and is determined by output current limit ramp-up
T.H.D. (Current):	<5% at 100% load for 208 to 220Vac
Input Transient Suppression:	Meets ANSI/IEEE C62.41 Category B3
Input Leakage Current:	<3.5mA @ 265Vac 60Hz for up to two rectifiers* >5mA @ 265Vac 60Hz for three or more rectifiers* [*plugged inside 1RU or 2RU shelf] See Warning note at the end of Important Safety Instructions page
Environmental	

Table 8: Specifications: Cordex HP 48 1.2kW, Switched Mode Rectifier (Continued) (Sheet 3 of 3)

Specifications: Cordex HP 48-1.2kW, Switched Mode Rectifier	
Operating Temperature:	-40 to +65°C (-40 to 149°F) -40 to +80°C (-40 to 176°F) [de-rated output power]
Storage Temperature:	-40 to +80°C (-40 to 176°F)
Humidity:	0 to 95% RH non-condensing
Elevation:	-500 to +2800m; to 4000m with temperature de-rated to 40°C (-1640 feet to 9186 feet; to 13124 feet with temperature de-rated to 104°F)
Mechanical	
MTBF:	222,469 hours ground benign @ 25°C (77°F)
Dimensions:	44mm H x 88mm W x 318mm D [1.73" H x 3.5" W x 12.5" D]
Weight:	1.23 kg (2.72 lb.)
Compliance	
EN 55022 (CISPR 22):	Information Technology Equipment – Radio Disturbance Characteristics – Limits and Methods of Measurement, Class A and Class B
EN 61000-3-2:	Harmonic Current Emissions
EN 61000-3-3:	Voltage Fluctuations and Flicker
EN 61000-4-2:	ESD Immunity
EN 61000-4-3:	Radiated Electromagnetic Immunity
EN 61000-4-4:	Electrical Fast Transient/Burst Immunity
EN 61000-4-5:	Power Line Surge Immunity
EN 61000-4-6:	Conducted Electromagnetic Immunity
EN 61000-4-11	Voltage Dips, Short Interruptions and Variations
GR-63-CORE:	Physical Protection
GR-1089-CORE:	Electromagnetic Compatibility and Electrical Safety
CE IEC/EN:	60950-1 CB Scheme

The above information is valid at the time of publication. Consult factory for up-to-date ordering information. Specifications are subject to change without notice.

13.2 CXCM1 HP Controller

Table 9: Specifications: CXCM1 HP Controller (Sheet 1 of 3)

Specifications: Basic Unit, CXCM1 HP	
Input Voltage:	12 to 60Vdc within rated limits
Current:	<200mA @ 52Vdc, <400mA @ 26.5Vdc, <800mA @ 13.2Vdc
MTBF:	95,000 hours (10.9 years), with display off OLED 84,000 hours @ 10% usage, 9,800 at 100% usage, at 25°C
Safety:	CSA 60950-1-03 IEC/EN 60950-1 CE Mark
EMC:	<p>The unit meets requirements of:</p> <ul style="list-style-type: none"> • EN 300 386-2 EMC and EMR, Telecommunications Network Equipment <p>Emissions:</p> <ul style="list-style-type: none"> • EN 55022 Class A (CISPR 22) • CFR47 (FCC) Part 15 Class A <p>Immunity:</p> <ul style="list-style-type: none"> • EN 61000-4-2 ESD EN 61000-4-3 • Radiated EN 61000-4-4 EFT /Burst • EN 61000-4-6 Conducted <p>Environmental:</p> <ul style="list-style-type: none"> • ETS 300 019-1-1 Environmental Conditions, Storage • ETS 300 019-1-2 Environmental Conditions, Transportation <p>NEBS:</p> <ul style="list-style-type: none"> • GR-63-CORE Physical Protection • GR-1089-CORE Electromagnetic Compatibility and Electrical Safety
<p>In accordance with FCC requirements, we provide the following statement as specified in the FCC guidelines for conformance to Part 15, Class A:</p>	
<p>NOTE: <i>This equipment has been tested and found to comply with the limits for a Class A digital device, pursuant to part 15 of the FCC Rules. These limits are designed to provide reasonable protection against harmful interference when the equipment is operated in a commercial environment. This equipment generates, uses, and can radiate radio frequency energy and, if not installed and used in accordance with the instruction manual, may cause harmful interference to radio communications. Operation of this equipment in a residential area is likely to cause harmful interference in which case the user will be required to correct the interference at his own expense.</i></p>	
<p>Any changes or modifications to this equipment not expressly described in this manual could void the FCC compliance.</p>	
<p>Environmental</p>	

Table 9: Specifications: CXCM1 HP Controller (Continued) (Sheet 2 of 3)

Specifications: Basic Unit, CXCM1 HP	
Temperature:	-40 to 75°C (-40 to 167°F) operating -40 to 80°C (-40 to 176°F) storage
Humidity:	5% to 95% RH non-condensing
Elevation:	-500 to +4000m (-1640 to 13124 ft)
Hardware	
CPU:	ARM A8
RAM:	128MB
Flash:	256MB
Display:	5-line, LCD matrix
Front Panel Controls:	Menu up and down, home and select buttons
LED's:	System OK (Green) Power System Minor Alarm (Yellow) Power System Major Alarm / Controller Fail (Red)
Audio:	Built-in speaker for alarm and popup message tones 70 dB
Dimensions:	44mm H x 88mm W x 318mm D (1.73" H x 3.5" W x 12.5" D)
Weight:	0.62 kg (1.36 lb.)
Mounting:	Modular on Cordex CXRF 48-1.2kW series shelves
Relay Outputs:	Four (4) Form C, 60Vdc 1A maximum
Digital Inputs:	Two (2), ±60Vdc
Analog Inputs:	One (1) DC voltage, 0 to 60Vdc, One (1) DC current, compatible with ±25mV to ±200mV shunts, Two (2) temperature, 0 to 5Vdc with power source
Communication Ports:	Ethernet RJ-45, USB 2.0, CAN (see shelf specifications)
Recommended Signal Wire Sizes	
Wire Size Range:	#16 to #26 AWG (1.5 to 0.14mm ²)
Temperature Rating:	90°C (194°F)
CAUTION: TO REDUCE RISK OF FIRE, USE ONLY #26 AWG (0.14mm²) OR LARGER WIRE.	

Table 9: Specifications: CXCM1 HP Controller (Continued) (Sheet 3 of 3)

Specifications: Basic Unit, CXCM1 HP	
The above information is valid at the time of publication. Consult factory for up-to-date ordering information. Specifications are subject to change without notice.	

13.3 CXCM1+ Controller

Table 10: Specifications: CXCM1+ Controller (Sheet 1 of 3)

Specifications: Basic Unit, CXCM1+	
Input Voltage:	17 to 60Vdc within rated limits
Current:	<100mA @ 48Vdc <200mA @ 24Vdc
MTBF:	472,000 hours @ 25°C (77°F)
EMC:	<p>The unit meets requirements of: Emissions:</p> <ul style="list-style-type: none"> • EN 55022 Class A (CISPR 22) • CFR47 (FCC) Part 15 Class A <p>Immunity:</p> <ul style="list-style-type: none"> • EN 61000-4-2 ESD EN 61000-4-3 • Radiated EN 61000-4-4 EFT /Burst • EN 61000-4-6 Conducted <p>NEBS:</p> <ul style="list-style-type: none"> • GR-63-CORE Physical Protection • GR-1089-CORE Electromagnetic Compatibility and Electrical Safety
In accordance with FCC requirements, we provide the following statement as specified in the FCC guidelines for conformance to Part 15, Class A:	

Table 10: Specifications: CXCM1+ Controller (Continued) (Sheet 2 of 3)

Specifications: Basic Unit, CXCM1+	
<p><i>NOTE: This equipment has been tested and found to comply with the limits for a Class A digital device, pursuant to part 15 of the FCC Rules. These limits are designed to provide reasonable protection against harmful interference in a residential installation. This equipment generates, uses, and can radiate radio frequency energy and, if not installed and used in accordance with the instructions, may cause harmful interference to radio communications. However, there is no guarantee that interference will not occur in a particular installation. If this equipment does cause harmful interference to radio or television reception, which can be determined by turning the equipment off and on, the user is encouraged to try to correct the interference by one or more of the following measures:</i></p> <ul style="list-style-type: none"> • Reorient or relocate the receiving antenna. • Increase the separation between the equipment and receiver. • Connect the equipment into an outlet on a circuit different from that to which the receiver is connected. • Consult the dealer or an experienced radio/TV technician for help. 	
<p>Any changes or modifications to this equipment not expressly described in this manual could void the FCC compliance.</p>	
Environmental	
Temperature:	-40 to 75°C (-40 to 167°F) operating -40 to 80°C (-40 to 176°F) storage
Humidity:	0 to 95% RH non-condensing
Elevation:	-500 to +4000m (-1640 to 13124 ft)
Hardware	
CPU:	Coldfire
RAM:	8MB
Flash:	4MB standard
Display:	4 digit LCD
Front Panel Controls:	Display pushbutton toggle switch for voltage (V) or current (A) Reset switch (soft reset button; hold for 3 seconds to reset IP)
LED's:	System OK (Green) Power System Minor Alarm (Yellow) Power System Major Alarm / Controller Fail (Red)
Audio:	Built-in speaker for alarm and popup message tones
Dimensions:	44mm H x 88mm W x 318mm D (1.73" H x 3.5" W x 12.5" D)
Weight:	0.62 kg (1.36 lb.)

Table 10: Specifications: CXCM1+ Controller (Continued) (Sheet 3 of 3)

Specifications: Basic Unit, CXCM1+	
Mounting:	Modular on Cordex CXRF 48-1.2kW series shelves (options for 1RU horizontal or 2RU vertical orientation depending on shelf)
Relay Outputs:	Seven (7) Form C, 60Vdc 1A maximum
Digital Inputs:	Two (2), 0 to 60Vdc
Analog Inputs:	One (1) DC voltage, 0 to 60Vdc One (1) DC current, $\pm 50\text{mV}$ Two (2) temperature, 0 to 20Vdc with power source
Communication Ports:	Ethernet RJ-45, CAN (see shelf specifications)
Recommended Signal Wire Sizes	
Wire Size Range:	#16 to #26 AWG (1.5 to 0.14mm ²)
Temperature Rating:	90°C (194°F)
<i>CAUTION: TO REDUCE RISK OF FIRE, USE ONLY #26 AWG (0.14mm²) OR LARGER WIRE.</i>	
The above information is valid at the time of publication. Consult factory for up-to-date ordering information. Specifications are subject to change without notice.	

AC, CXCM1+ I/O, RECTIFIER CONNECTIONS - ALL CONFIGURATIONS

REVISIONS					
LT#	DESCRIPTION	DRW	DATE	CHK	APP

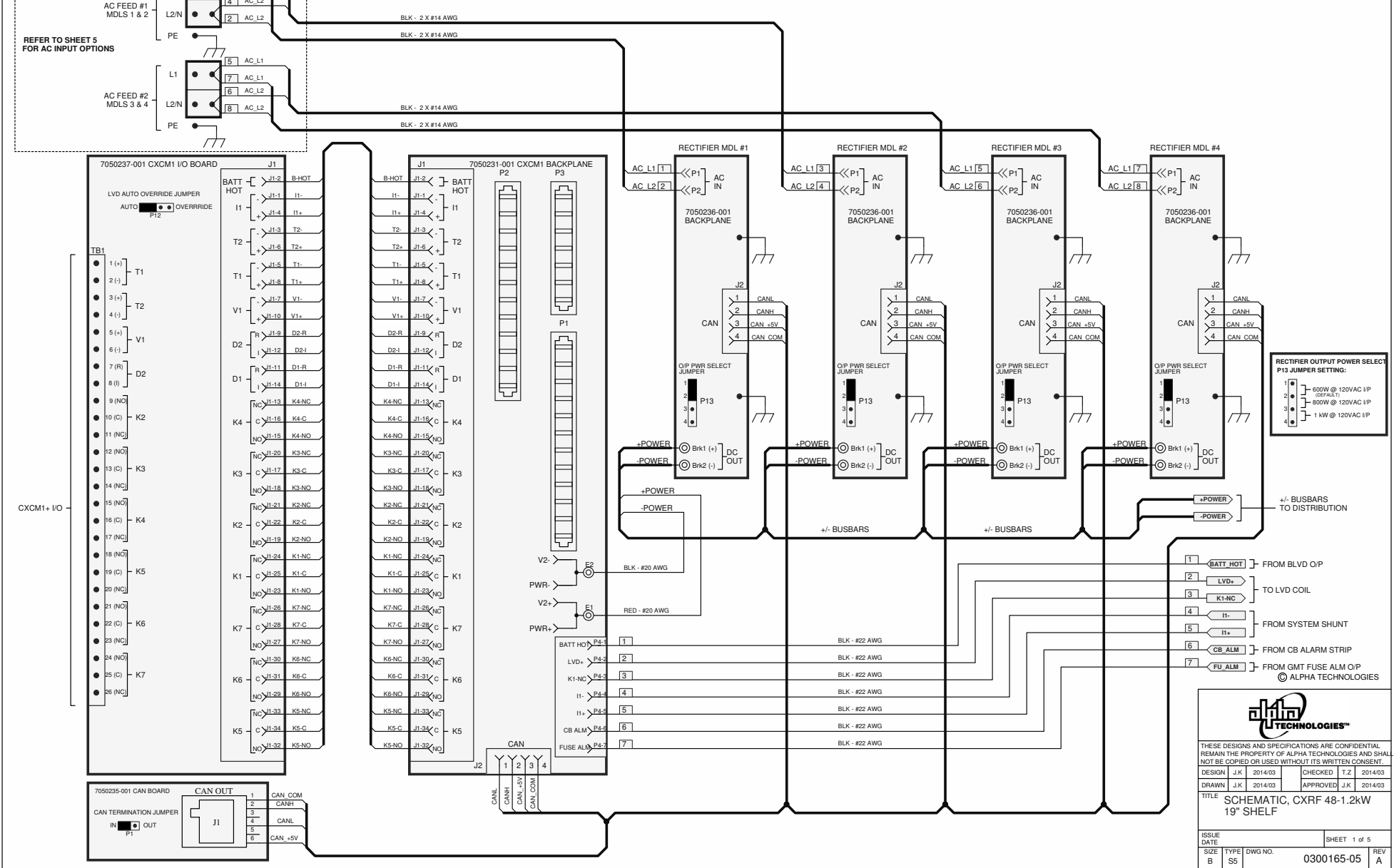

RECTIFIER OUTPUT POWER SELECT P13 JUMPER SETTING:

1	60W @ 120VAC I/P
2	(DEFAULT)
3	800W @ 120VAC I/P
4	1 kW @ 120VAC I/P

- 1 BATT HOT FROM BLVD O/P
- 2 LVD+ TO LVD COIL
- 3 K1-NC
- 4 I1- FROM SYSTEM SHUNT
- 5 I1+
- 6 CB ALM FROM CB ALARM STRIP
- 7 FU ALM FROM GMT FUSE ALM O/P

ALPHA TECHNOLOGIES™

THESE DESIGNS AND SPECIFICATIONS ARE CONFIDENTIAL. REMAIN THE PROPERTY OF ALPHA TECHNOLOGIES AND SHALL NOT BE COPIED OR USED WITHOUT ITS WRITTEN CONSENT.

DESIGN	J.K.	2014/03	CHECKED	T.Z.	2014/03
DRAWN	J.K.	2014/03	APPROVED	J.K.	2014/03

TITLE: SCHEMATIC, CXRF 48-1.2KW 19" SHELF

ISSUE DATE	SHEET 1 of 5	
SIZE	TYPE	DWG NO.
B	SS	0300165-05
		REV
		A

**DISTRIBUTION OPTION: 2 LOAD / 2 BATT CB, 10 FUSE DISTRIBUTION, LOAD LVD
CONFIGURATION 7400551-002**

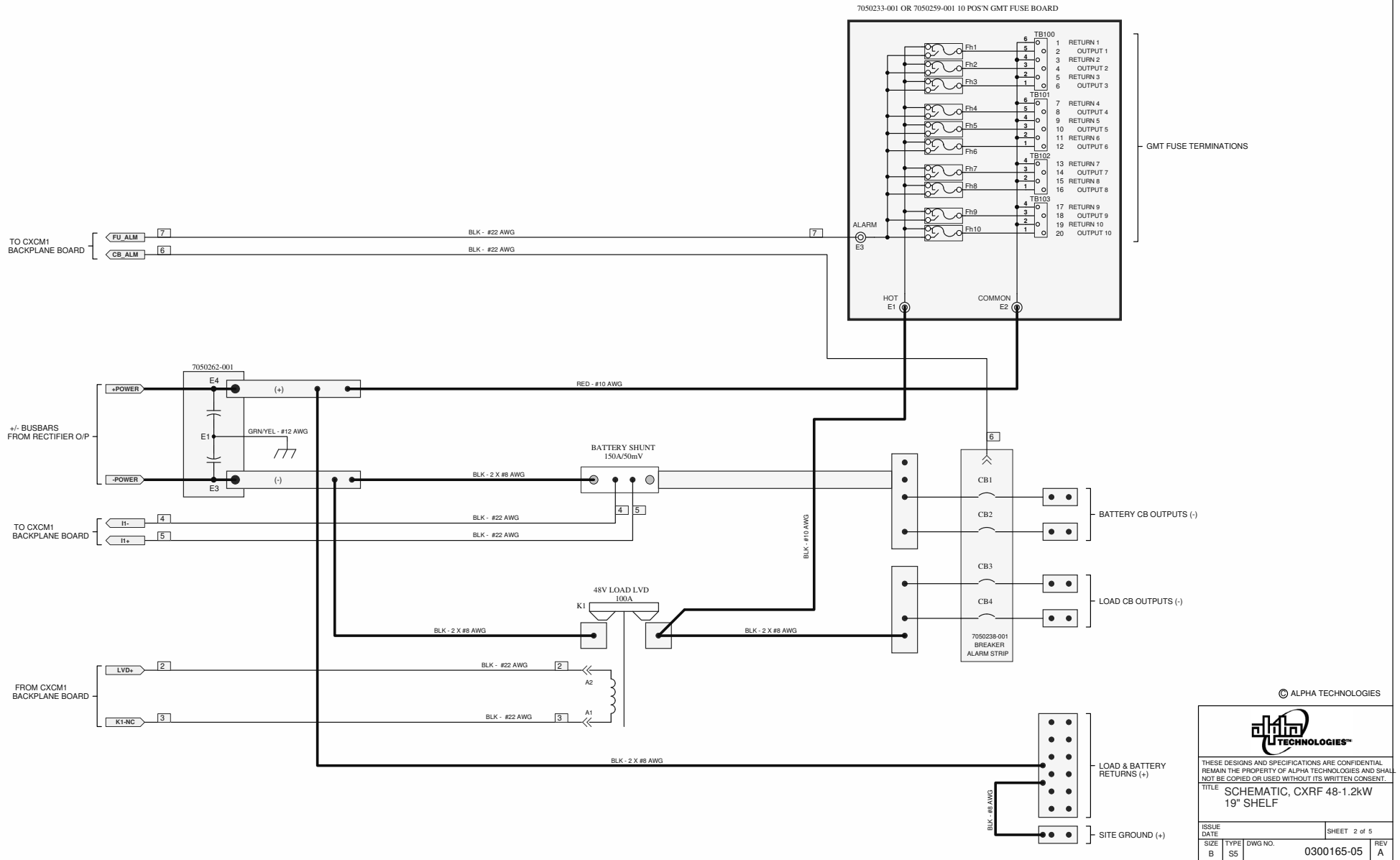

© ALPHA TECHNOLOGIES



THESE DESIGNS AND SPECIFICATIONS ARE CONFIDENTIAL. REMAIN THE PROPERTY OF ALPHA TECHNOLOGIES AND SHALL NOT BE COPIED OR USED WITHOUT ITS WRITTEN CONSENT.

TITLE: SCHEMATIC, CXRF 48-1.2KW 19" SHELF

ISSUE DATE	SHEET 2 of 5	
SIZE	TYPE	DWG NO.
B	SS	0300165-05
REV	A	

**DISTRIBUTION OPTION: 2 LOAD / 2 BATT CB, 10 FUSE DISTRIBUTION, BATTERY LVD
CONFIGURATION 7400551-001**

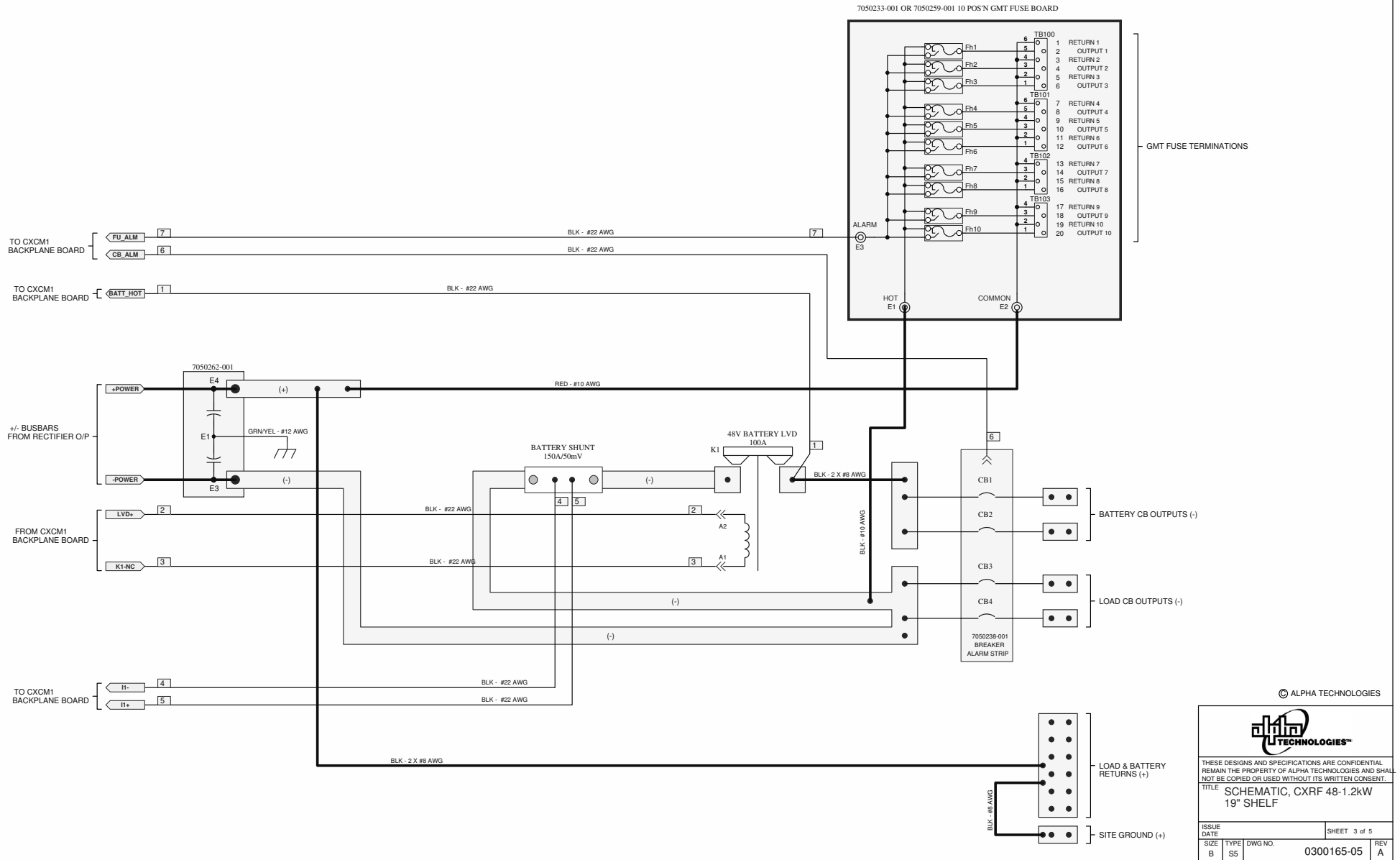

© ALPHA TECHNOLOGIES



THESE DESIGNS AND SPECIFICATIONS ARE CONFIDENTIAL. REMAIN THE PROPERTY OF ALPHA TECHNOLOGIES AND SHALL NOT BE COPIED OR USED WITHOUT ITS WRITTEN CONSENT.

TITLE: SCHEMATIC, CXRF 48-1.2KW 19" SHELF

ISSUE DATE	SHEET 3 of 5	
SIZE	TYPE	DWG NO.
B	SS	0300165-05
		REV
		A

**DISTRIBUTION OPTION: 4 LOAD CB, 10 FUSE DISTRIBUTION, BATTERY LVD
CONFIGURATION 7400551-003**

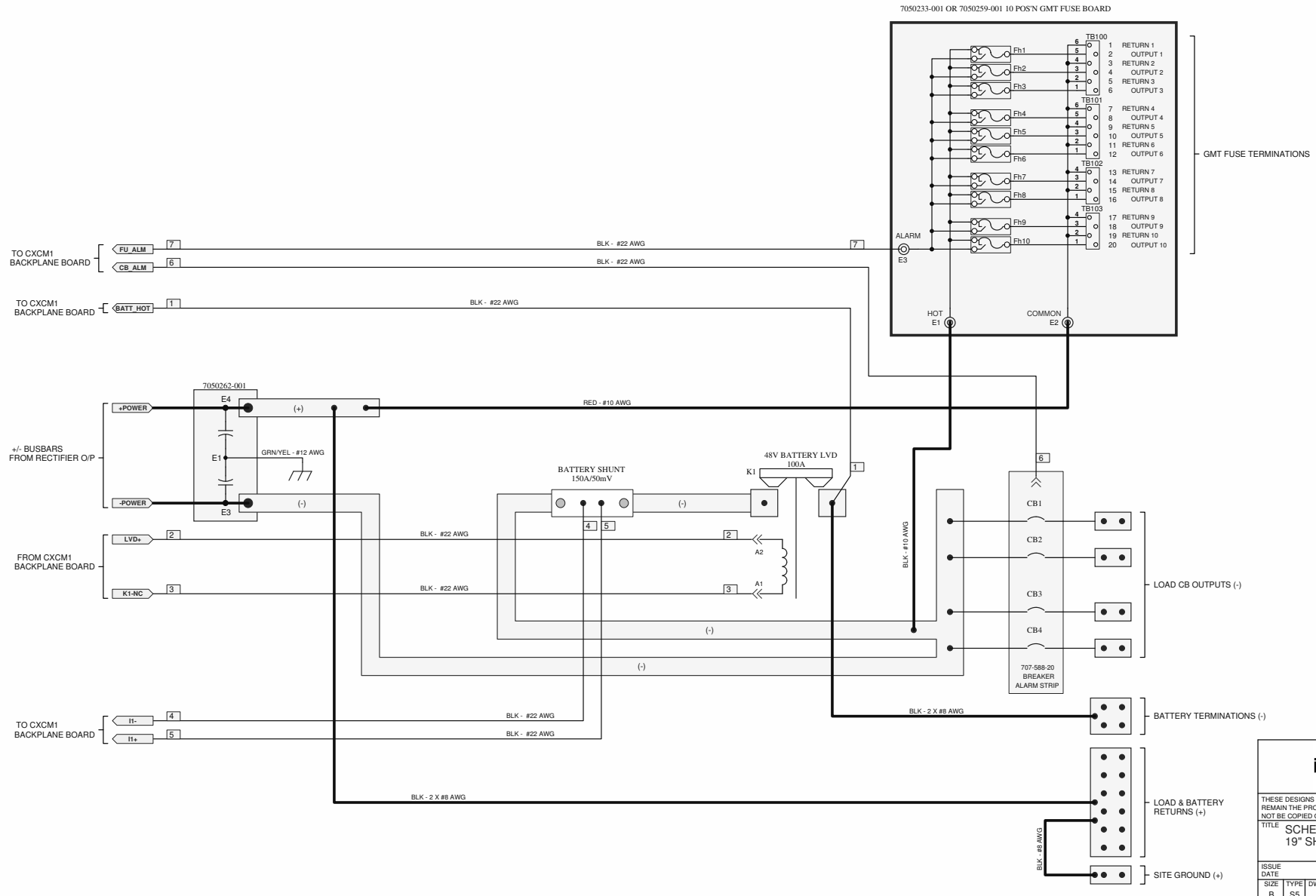

© ALPHA TECHNOLOGIES



THESE DESIGNS AND SPECIFICATIONS ARE CONFIDENTIAL
REMAIN THE PROPERTY OF ALPHA TECHNOLOGIES AND SHALL
NOT BE COPIED OR USED WITHOUT ITS WRITTEN CONSENT.

TITLE SCHEMATIC, CXRF 48-1.2KW
19" SHELF

ISSUE	SHEET 4 of 5		
DATE	SIZE	TYPE	DWG NO.
	B	SS	0300165-05
			REV A

AC INPUT OPTIONS

IEC RECEPTACLE

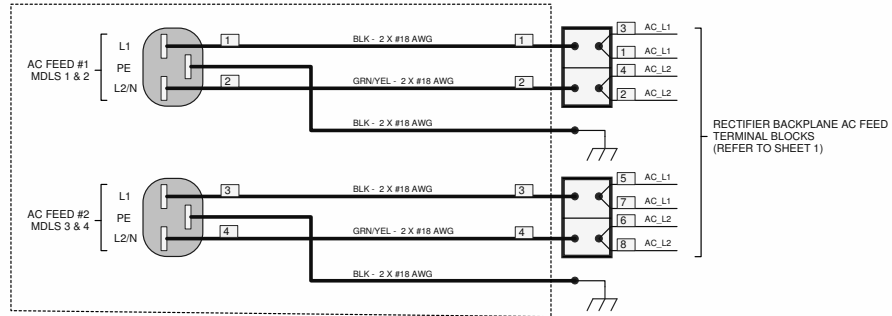

POWER CORD WITH NEMA PLUG

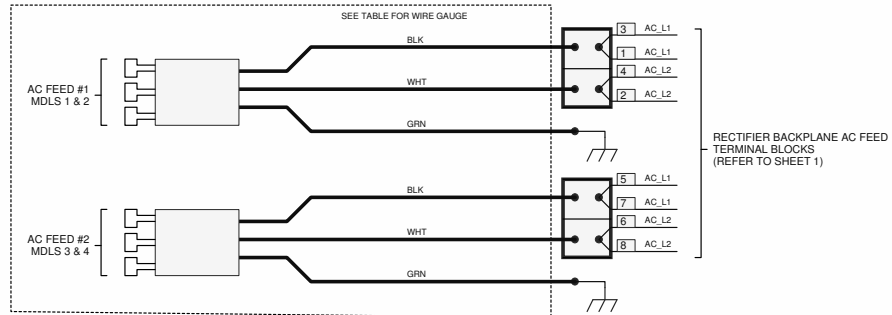

NEMA PLUG	WIRE GAUGE
L5-15P	#14 AWG
L5-20P	#12 AWG
L5-30P	#10 AWG

© ALPHA TECHNOLOGIES



THESE DESIGNS AND SPECIFICATIONS ARE CONFIDENTIAL AND SHALL REMAIN THE PROPERTY OF ALPHA TECHNOLOGIES AND SHALL NOT BE COPIED OR USED WITHOUT ITS WRITTEN CONSENT.

TITLE SCHEMATIC, CXRF 48-1.2kW 19" SHELF

ISSUE DATE	SHEET 5 of 5
SIZE B	TYPE SS
DWG NO. 0300165-05	REV A

5

4

3

2

1

DO NOT SCALE DRAWING

REVISIONS				
LTR	DESCRIPTION	DWN	DATE	CHK
A	INITIAL RELEASE	SL	2/20/2014	VB
B	REMOVED PLUG CONFIGURATION	JAWA	12/01/17	VPB

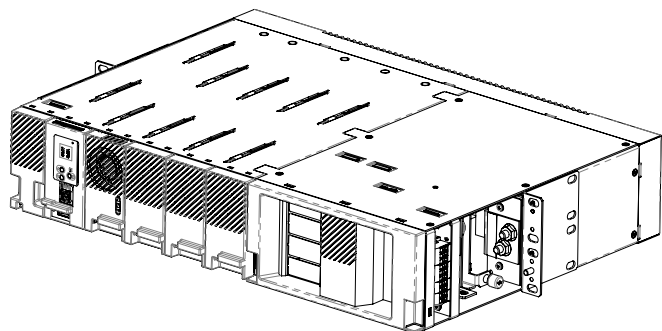

FRONT, RIGHT ISOMETRIC VIEW
19" RACK MOUNTED SHELF

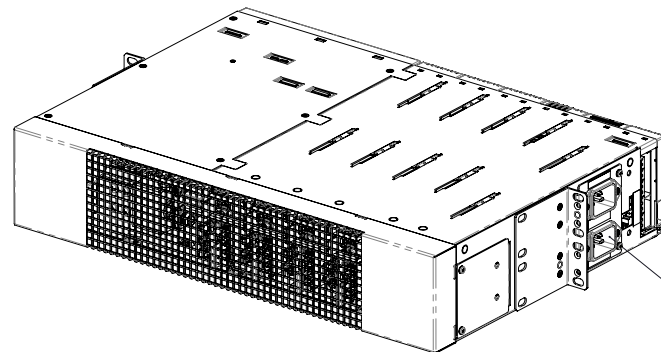



2X IEC FLANGE MOUNT
INLET SOCKET

REAR, RIGHT ISOMETRIC VIEW
19" RACK MOUNTED SHELF

E
D
C
B
A

E
D
C
B
A

UNLESS OTHERWISE SPECIFIED DIM ARE IN MM X 1 X.X 0.5 X.XX 0.25 ANGULAR: ±3° INTERPRET DIM AND TOL PER ASME Y14.5M-1994	THESE DESIGNS AND SPECIFICATIONS ARE CONFIDENTIAL. REMAIN THE PROPERTY OF ALPHA TECHNOLOGIES LTD. AND SHALL NOT BE COPIED OR USED WITHOUT ITS WRITTEN CONSENT		 TITLE: OUTLINE DRAWING, CXRF 48-1.2kw 19" SHELF
	APPROVALS	DATE	
THIRD ANGLE PROJECTION	DRAWN SL	Feb-20-14	SIZE DWG NO. 0300165-06 REV B
	CHECKED VB	Feb-20-14	SCALE: 1:5 SHEET 1 OF 2
© ALPHA TECHNOLOGIES LTD			

5

4

3

2

1

5

4

3

2

1

DO NOT SCALE DRAWING

E

D

C

B

A

E

D

C

B

A

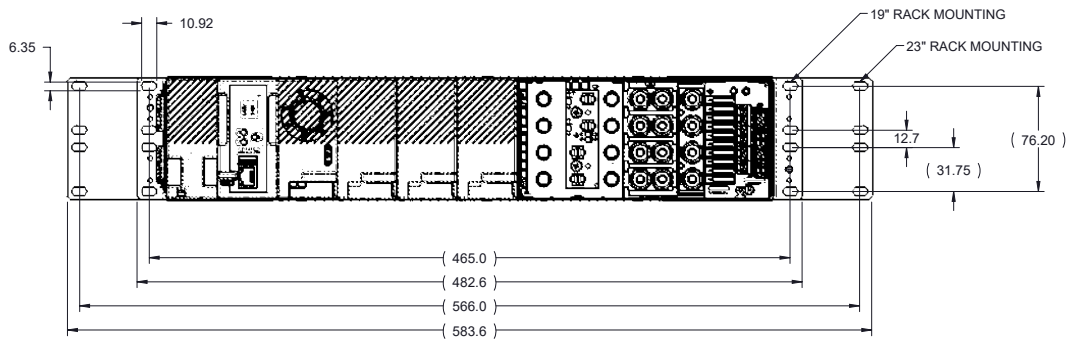
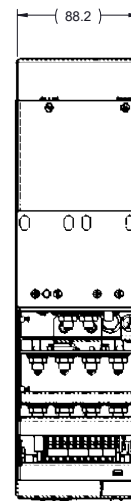
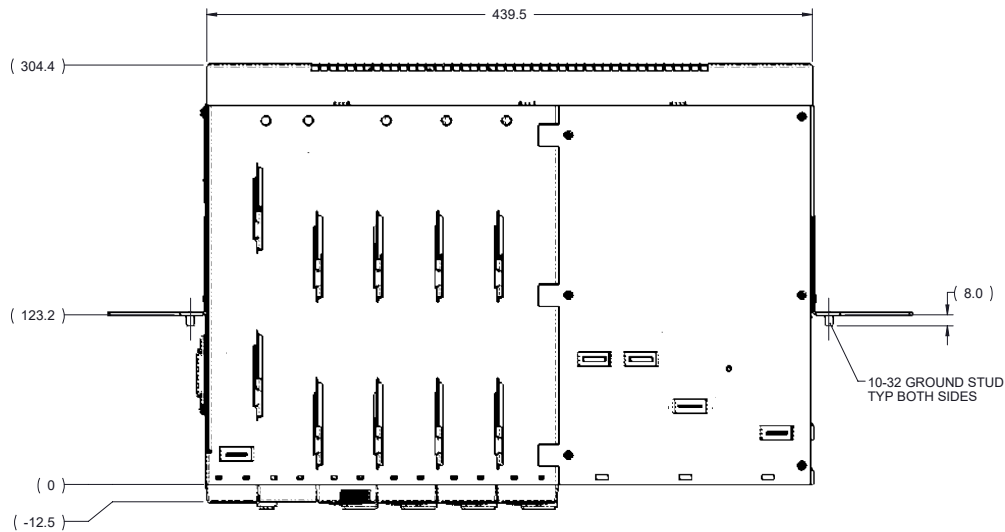
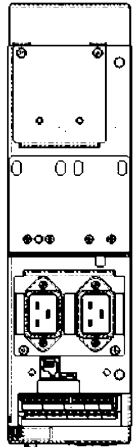

TITLE: OUTLINE DRAWING, CXRF 48-1.2kw 19" SHELF			
SIZE B	DWG NO. 0300165-06	REV B	
SCALE: 1:5	SHEET	2 OF 2	

5

4

3

2

1

5

4

3

2

1

DO NOT SCALE DRAWING

LTR	DESCRIPTION	DWN	DATE	CHK
A	INITIAL RELEASE	SL	2/25/2014	VB
B	ADDED CXCM1 HP OPTION; ADDED SHEET 3	JAWA	11/04/2017	VPB

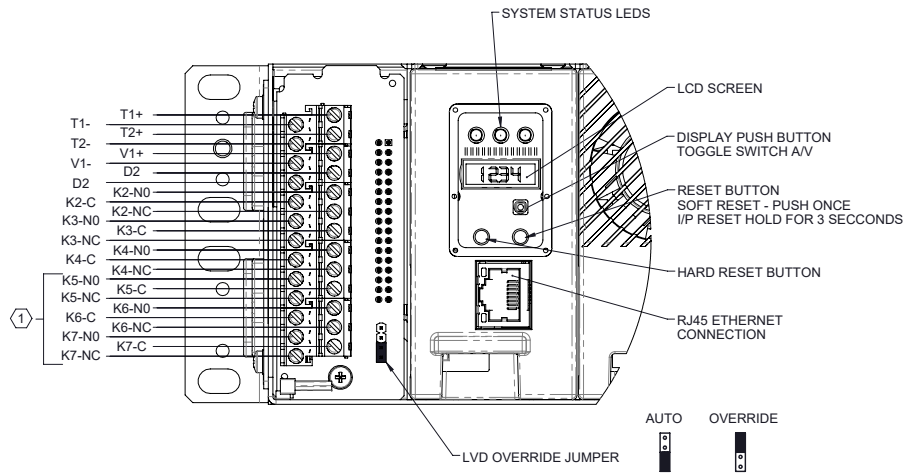
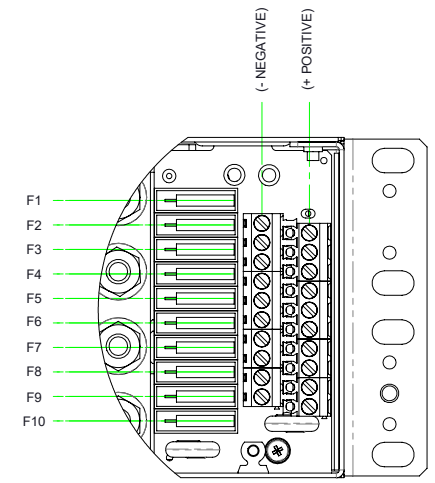
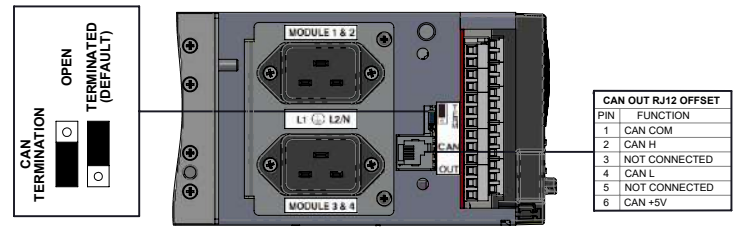
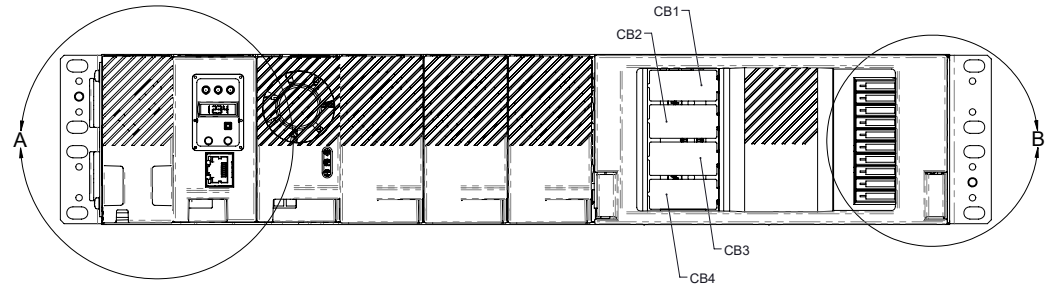
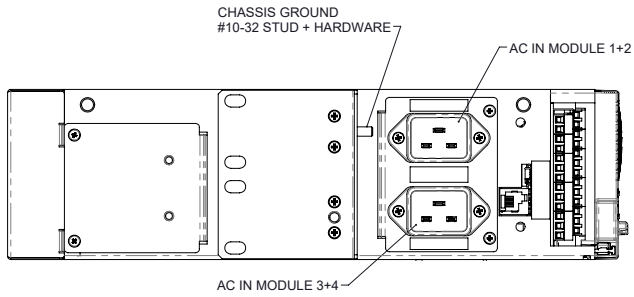

NOTES UNLESS OTHERWISE SPECIFIED:

DETAIL A
CORDEX CXCM1+ SYSTEM CONTROLLER AND I/O
 (FRONT COVER REMOVED FOR CLARITY)
 SEE SHEET 3 FOR CXCM1 HP CONTROLLER OPTION

RELAY OUTPUTS K5-K7 ARE NOT AVAILABLE WITH CXCM1 HP CONTROLLER OPTION.

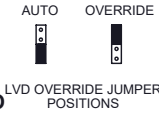

UNLESS OTHERWISE SPECIFIED DIM ARE IN MM

X	1
X.X	0.5
X.XX	0.25
ANGULAR:	±3°

INTERPRET DIM AND TOL PER ASME Y14.5M-1994

THIRD ANGLE PROJECTION

THESE DESIGNS AND SPECIFICATIONS ARE CONFIDENTIAL. REMAIN THE PROPERTY OF ALPHA TECHNOLOGIES LTD. AND SHALL NOT BE COPIED OR USED WITHOUT ITS WRITTEN CONSENT

APPROVALS	DATE
DRAWN SL	Feb-26-14
CHECKED VB	Feb-26-14

© ALPHA TECHNOLOGIES LTD

TITLE: CUSTOMER CONNECTION
CXRF 48kw 19" SHELF

SIZE B DWG NO. 0300165-08 REV B

SCALE: 1:1 SHEET 1 OF 3

5

4

3

2

1

5

4

3

2

1

DO NOT SCALE DRAWING

E

D

C

B

A

E

D

C

B

A

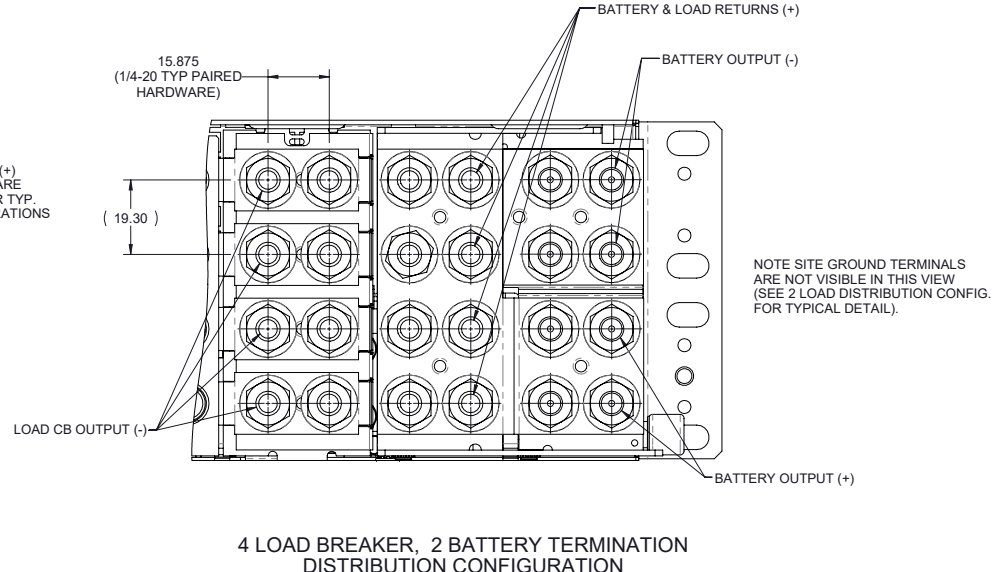
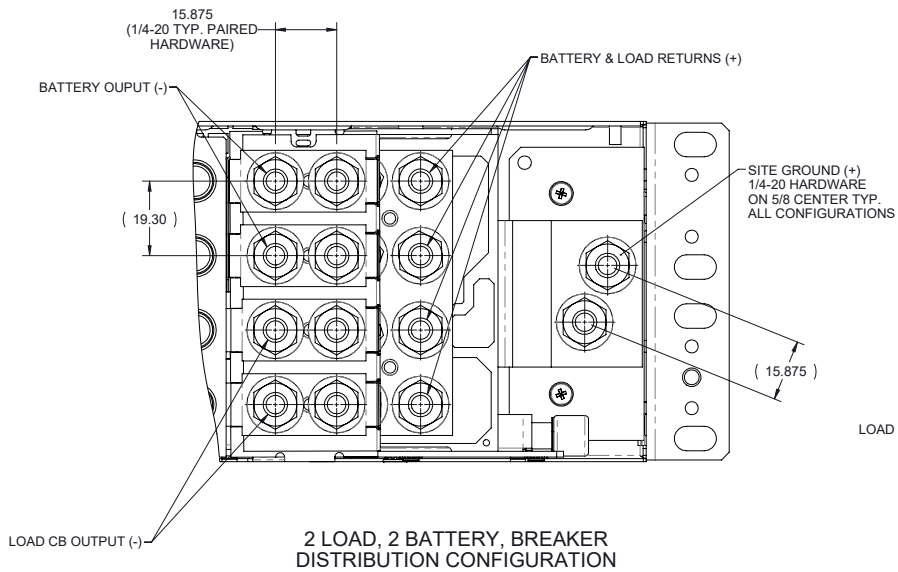

TITLE: CUSTOMER CONNECTION CXRF 48kw 19" SHELF		
SIZE B	DWG NO. 0300165-08	REV B
SCALE: 1:5	SHEET	2 OF 3

5

4

3

2

1

5

4

3

2

1

E

D

C

B

A

E

D

C

B

A

DO NOT SCALE DRAWING

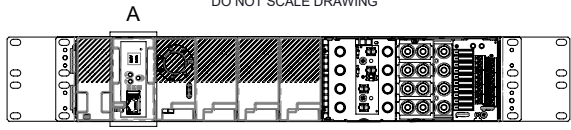

STATUS DISPLAY RESET

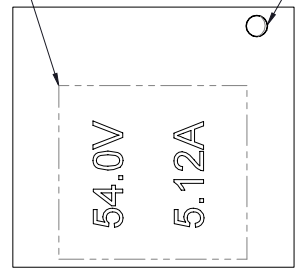

DETAIL AA
SCALE: 3 : 1

MENU CONTROL

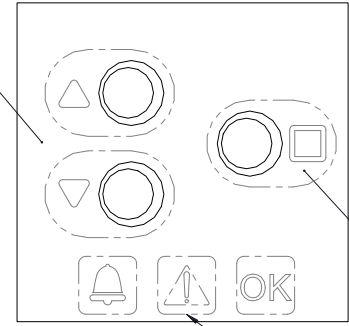

DETAIL AB
SCALE: 3 : 1

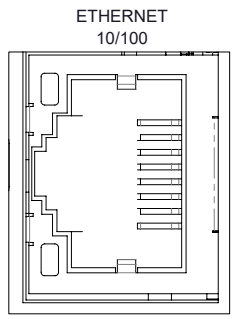

DETAIL AD
SCALE: 3 : 1

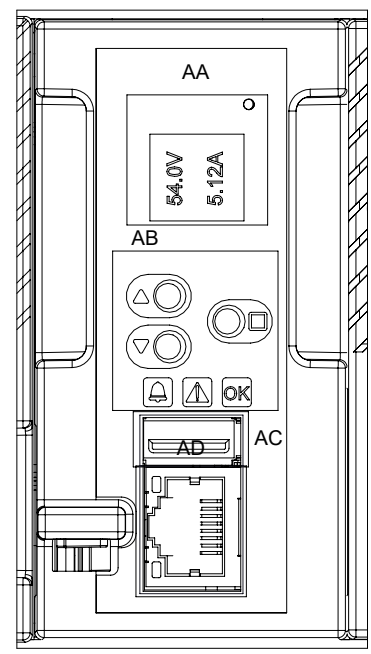

CORDEX CXCM1 HP SYSTEM CONTROLLER
DETAIL A

USB 2.0 PORT

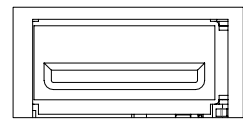

DETAIL AC
SCALE: 3 : 1

MENU SELECT / BUTTON C

ALARM STATUS

TITLE: CUSTOMER CONNECTION CXRF 48kw 19" SHELF		
SIZE B	DWG NO. 0300165-08	REV B
SCALE: 1:5	SHEET	3 OF 3

5

4

3

2

1

REVISIONS				
LTR	DESCRIPTION	DRW	DATE	CHK
A	BP12708, Connection on DB25 (P4) Corrected	WH	2015-01-10	MP
B	REV A was PADS Schematic	WH	2015-09-10	MP

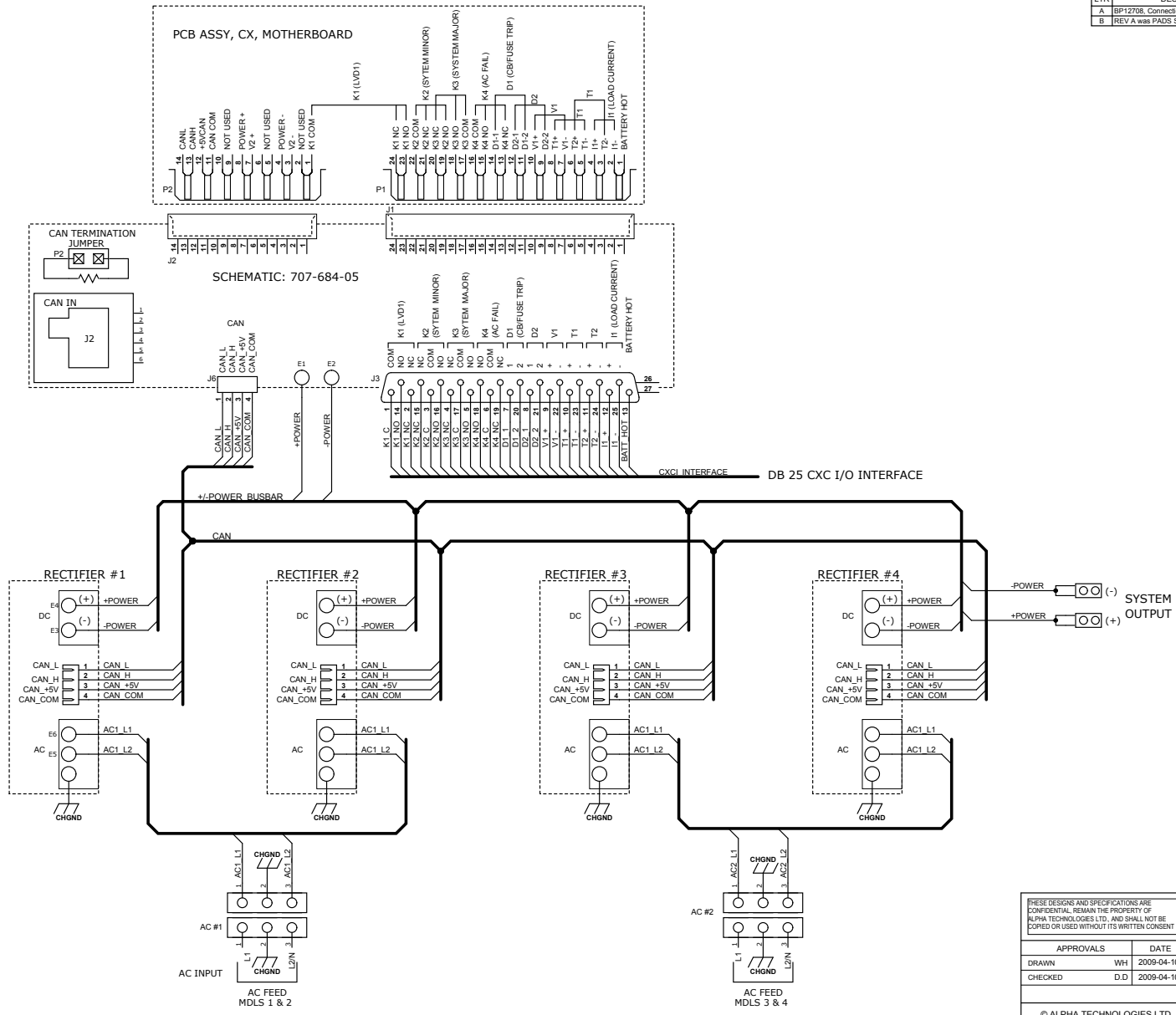

THESE DESIGNS AND SPECIFICATIONS ARE CONFIDENTIAL. REMAIN THE PROPERTY OF ALPHA TECHNOLOGIES LTD. AND SHALL NOT BE COPIED OR USED WITHOUT ITS WRITTEN CONSENT	
APPROVALS	DATE
DRAWN WH	2009-04-10
CHECKED D.D	2009-04-10

		TITLE	SCHEMATIC, Shelf	REV	B
		19" 1RU, 4 Mdl			
SIZE	DWG NO.	030-835-04			
SCALE	NTS	SHEET	1 of 1		

DO NOT SCALE DRAWING

REVISIONS				
LTR	DESCRIPTION	DWN	DATE	CHK
PC	REDESIGNED, PA, PB NOT RELEASED	WH	2009/05	
A	REDESIGNED	ZL	2014/01	
B	REVERSED TO OLD DESIGN	WH	2015/09	

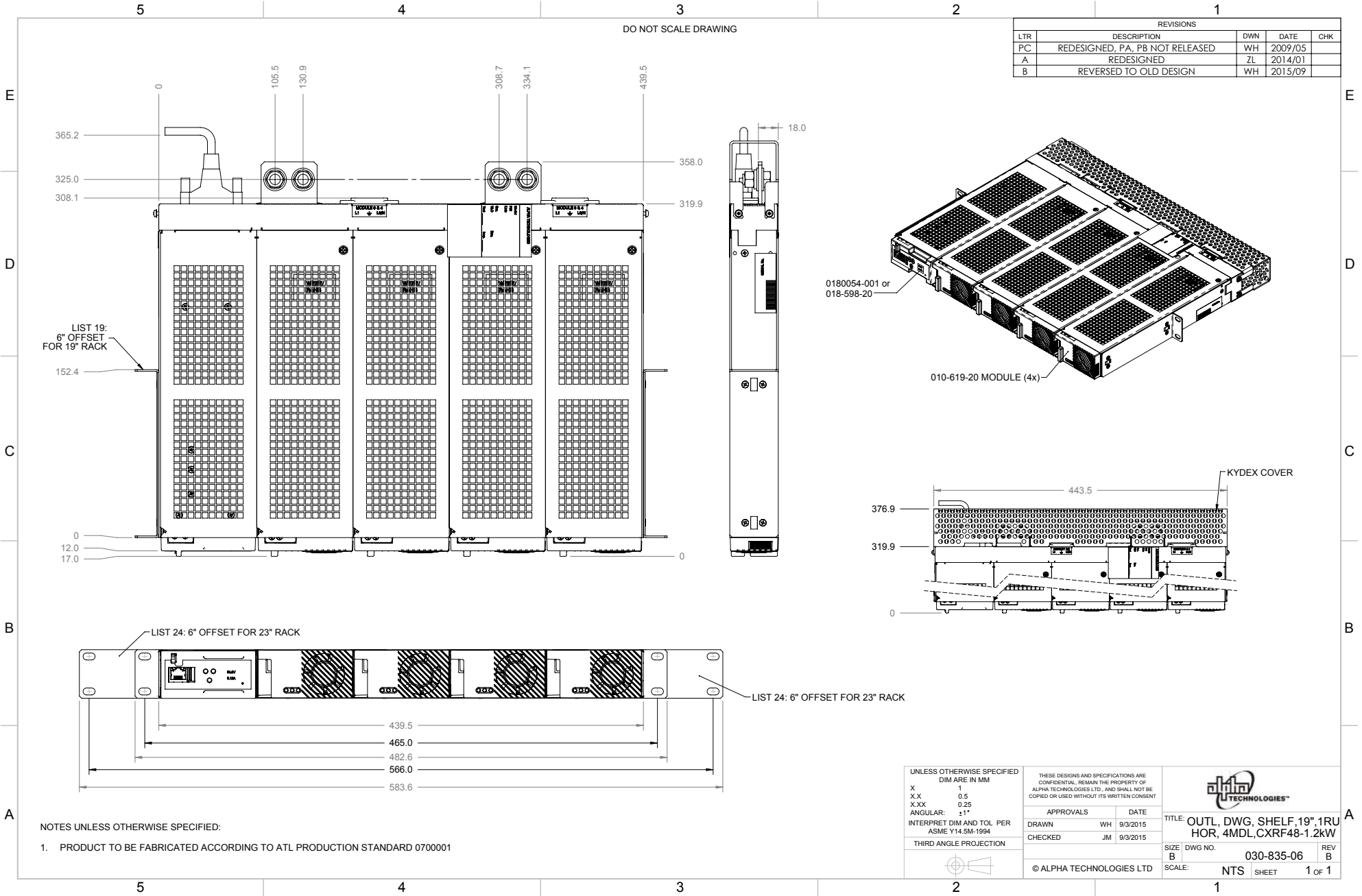

LIST 19:
6" OFFSET
FOR 19" RACK

152.4

0
12.0
17.0

5

4

3

2

1

105.5
130.9

308.7
334.1

439.5

365.2
325.0
308.1

358.0
319.9

18.0

0180054-001 or
018-598-20

010-619-20 MODULE (4x)

KYDEX COVER

376.9
319.9

443.5

LIST 24: 6" OFFSET FOR 23" RACK

LIST 24: 6" OFFSET FOR 23" RACK

439.5
465.0
482.6
566.0
583.6

NOTES UNLESS OTHERWISE SPECIFIED:

1. PRODUCT TO BE FABRICATED ACCORDING TO ATL PRODUCTION STANDARD 0700001

UNLESS OTHERWISE SPECIFIED DIM ARE IN MM	
X	1
X.X	0.5
X.XX	0.25
ANGULAR:	±1°
INTERPRET DIM AND TOL PER ASME Y14.5M-1994	
THIRD ANGLE PROJECTION	

THESE DESIGNS AND SPECIFICATIONS ARE CONFIDENTIAL. REMAIN THE PROPERTY OF ALPHA TECHNOLOGIES LTD. AND SHALL NOT BE COPIED OR USED WITHOUT ITS WRITTEN CONSENT			
APPROVALS		DATE	
DRAWN	WH	9/3/2015	
CHECKED	JM	9/3/2015	
© ALPHA TECHNOLOGIES LTD			

		TITLE: OUTL, DWG, SHELF, 19", 1RU HOR, 4MDL, CXRF48-1.2kW	
		SIZE: DWG NO. B 030-835-06	REV B
SCALE: NTS		SHEET 1 OF 1	

5

4

3

2

1

5

4

3

2

1

DETAIL D

DO NOT SCALE DRAWING

REVISIONS				
LTR	DESCRIPTION	DWN	DATE	CHK
P/A	First Release	WH	05/01/2009	MC
A	New Design	ZL	01/09/2014	KL
B	Reversed to old Design, Option 400 Added	WH	09/09/2015	LS

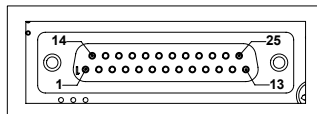

PIN	FUNCTION
1	K1-COM
2	K1-NC
3	K2-COM
4	K3-NC
5	K3-NO
6	K4-COM
7	D1-1
8	D2-1
9	V1+
10	T1+
11	T2+
12	I1+
13	BATT HOT
14	K1-NO
15	K2-NC
16	K2-NO
17	K3-COM
18	K4-NO
19	K4-NC
20	D1-2
21	D2-2
22	V1-
23	T1-
24	T2-
25	I1-

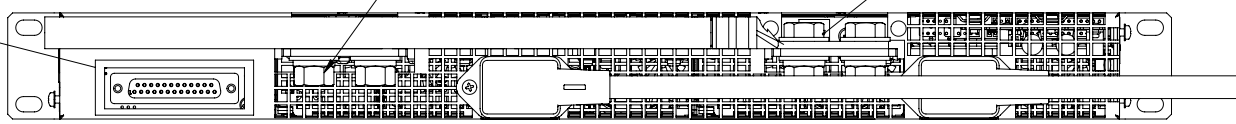

CAN TERMINATION

DETAIL A

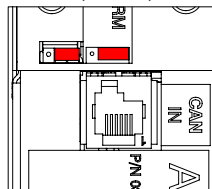
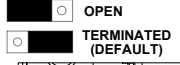

PIN	FUNCTION
1	CAN COM
2	CAN H
3	NOT CONNECTED
4	CAN L
5	NOT CONNECTED
6	CAN +5V

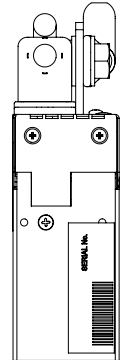
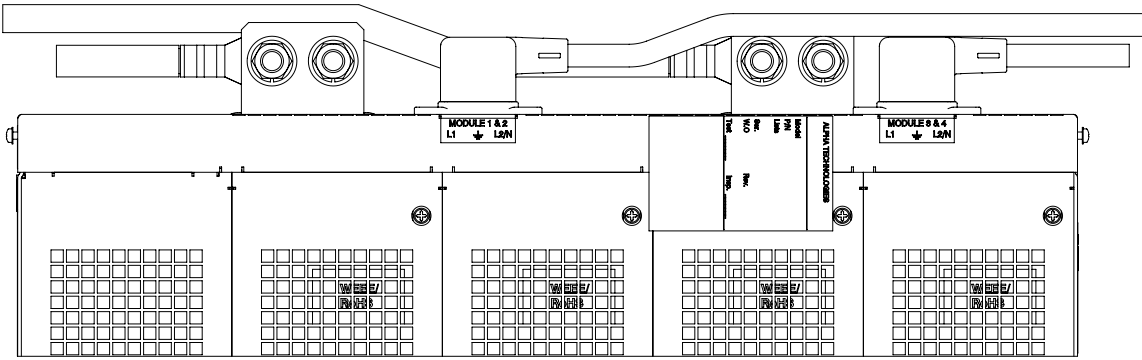
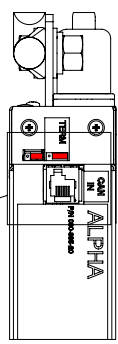

DB9 (FOR ARGUS DC MODEM USE ONLY)	
PIN	FUNCTION
1	DCD
2	RX
3	TX
4	DTR
5	COM
6	DSR
7	RTS
8	CTS
9	RI

DETAIL C

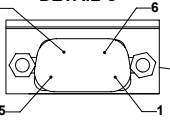

OPTION 99

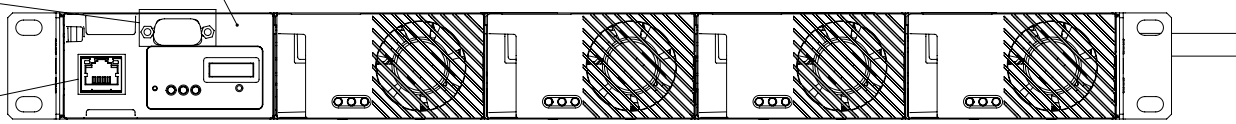

DETAIL B

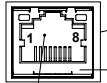

ETHERNET 10/100

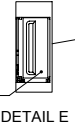

USB 2.0 PORT

ALARM STATUS

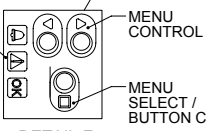

MENU CONTROL

MENU SELECT / BUTTON C

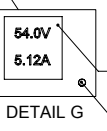

54.0V 5.12A

STATUS DISPLAY

RESET

OPTION 400

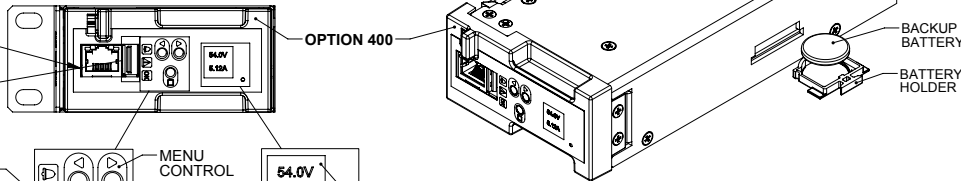

BACKUP BATTERY

BATTERY HOLDER

THESE DESIGNS AND SPECIFICATIONS ARE CONFIDENTIAL. REMAIN THE PROPERTY OF ALPHA TECHNOLOGIES LTD. AND SHALL NOT BE COPIED OR USED WITHOUT ITS WRITTEN CONSENT



APPROVALS	DATE
DRAWN WH	5/15/2009
CHECKED MC	5/15/2009

TITLE: CUSTOMER CONN. SHELF
19", 1RU HOR 4MDL

© ALPHA TECHNOLOGIES LTD

SIZE DWG NO. 030-835-08 REV B
SCALE: NTS SHEET 1 OF 1

5

4

3

2

1

REVISIONS					
LTR	DESCRIPTION	DRW	DATE	CHK	APP
A	REVISED PER NEW BACKPLANE PCB CONVERTED TO ALTIUM	JK	2017/06	WH	JK

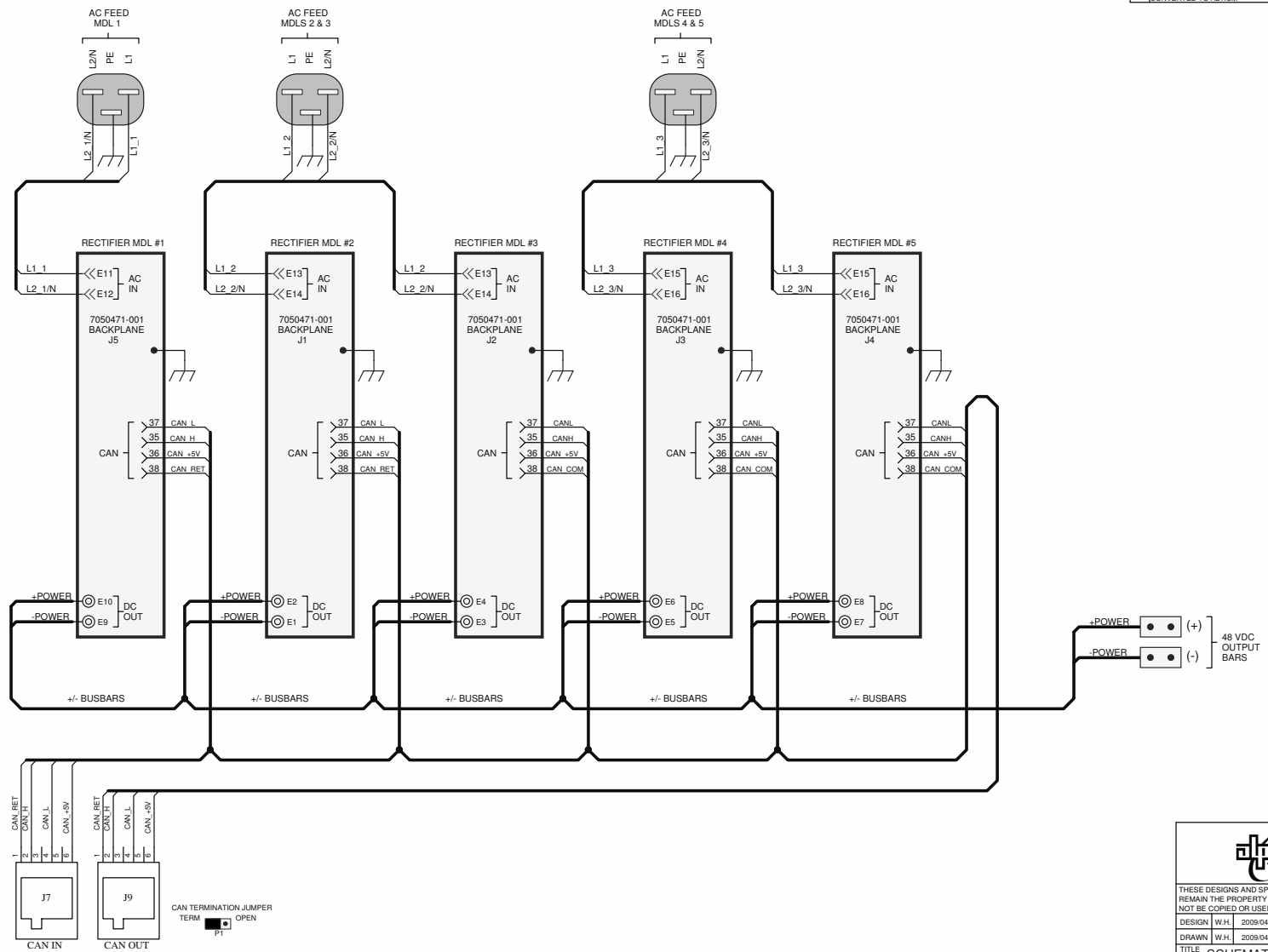

© ALPHA TECHNOLOGIES



THESE DESIGNS AND SPECIFICATIONS ARE CONFIDENTIAL. REMAIN THE PROPERTY OF ALPHA TECHNOLOGIES AND SHALL NOT BE COPIED OR USED WITHOUT ITS WRITTEN CONSENT.

DESIGN	W.H.	2009/04	CHECKED	
DRAWN	W.H.	2009/04	APPROVED	
TITLE				
SCHEMATIC, SHELF, 19", 1 RU HOR, 5 MDL, CXRF 48-1.2KW				
ISSUE DATE			SHEET 1 of 1	
SIZE	TYPE	DWG NO.	REV A	
B	SS	030-845-05		

DO NOT SCALE DRAWING

REVISIONS				
LTR	DESCRIPTION	DWN	DATE	CHK
A	UPDATED FOR REDESIGNED SHELF	ZL	JAN-16-14	JMAR
B	UPDATED LABELS	LW	6/28/2016	ZL
C	UPDATED AC INPUT LABELS	ZL	6/29/2017	JK

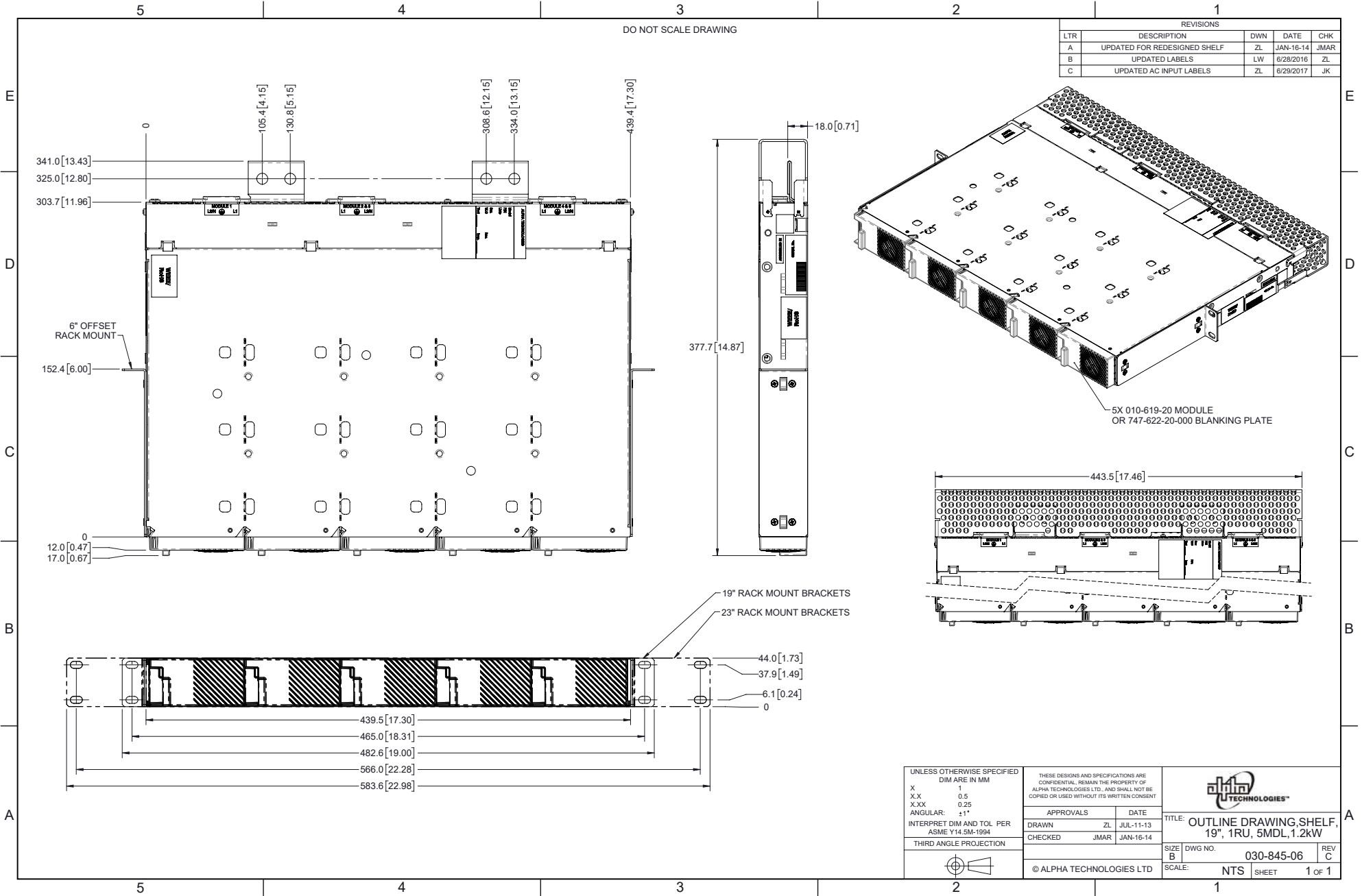

UNLESS OTHERWISE SPECIFIED DIM ARE IN MM X 1 X.X 0.5 X.XX 0.25 ANGULAR: ±1° INTERPRET DIM AND TOL PER ASME Y14.5M-1994 THIRD ANGLE PROJECTION	THESE DESIGNS AND SPECIFICATIONS ARE CONFIDENTIAL. REMAIN THE PROPERTY OF ALPHA TECHNOLOGIES LTD. AND SHALL NOT BE COPIED OR USED WITHOUT ITS WRITTEN CONSENT			
	APPROVALS DRAWN ZL CHECKED JMAR	DATE JUL-11-13 JAN-16-14		TITLE: OUTLINE DRAWING, SHELF, 19", 1RU, 5MDL, 1.2KW
	© ALPHA TECHNOLOGIES LTD		SIZE DWG NO. B 030-845-06	
			SCALE: NTS	SHEET 1 OF 1

5 4 3 2 1

DO NOT SCALE DRAWING

REVISIONS				
LTR	DESCRIPTION	DWN	DATE	CHK
A	UPDATED FOR REDESIGNED SHELF	ZL	JAN-16-14	JMAR
B	UPDATD LABELS	LW	6/28/2016	ZL
C	UPDATED AC INPUT LABELS	ZL	6/29/2017	JK

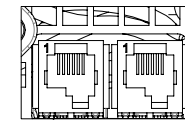
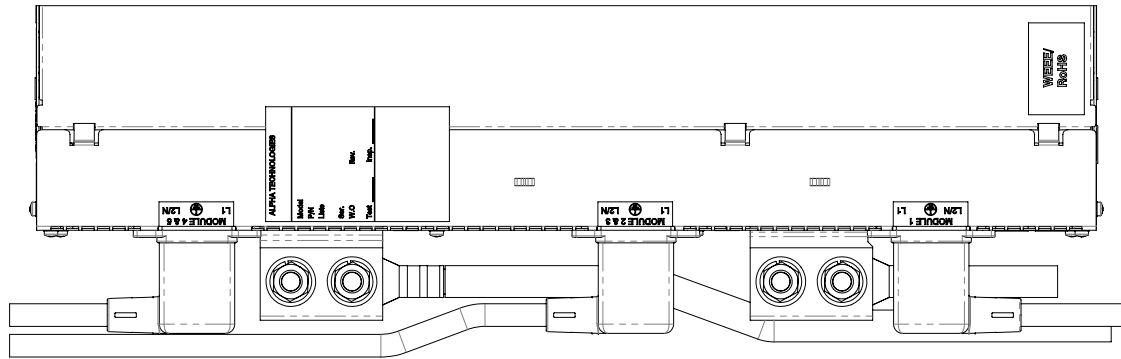

CAN IN RJ12 OFFSET	
PIN	FUNCTION
1	CAN COM
2	CAN H
3	NOT CONNECTED
4	CAN L
5	NOT CONNECTED
6	CAN +5V

DETAIL B
CABLES REMOVED FOR CLARITY

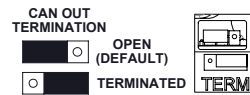
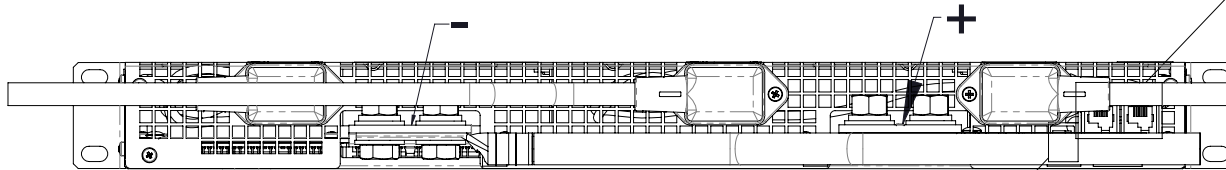

DETAIL A
CABLES REMOVED FOR CLARITY

UNLESS OTHERWISE SPECIFIED
DIM ARE IN MM

X	1
X.X	0.5
X.XX	0.25
ANGULAR:	±1°

INTERPRET DIM AND TOL PER
ASME Y14.5M-1994

THIRD ANGLE PROJECTION

THESE DESIGNS AND SPECIFICATIONS ARE
CONFIDENTIAL. REMAIN THE PROPERTY OF
ALPHA TECHNOLOGIES LTD. AND SHALL NOT BE
COPIED OR USED WITHOUT ITS WRITTEN CONSENT

APPROVALS		DATE
DRAWN	ZL	JUL-11-13
CHECKED	JMAR	JAN-16-14

© ALPHA TECHNOLOGIES LTD

		TITLE: CUSTOMER CONN, 19" SHELF, 1RU, 5MDL, 1.2KW	
		SIZE B	DWG NO. 030-845-08
SCALE: 1:1		SHEET	1 OF 1

5 4 3 2 1

E
D
C
B
A

E
D
C
B
A

REVISION				
LT#	DESCRIPTION	DRW	DATE	CHK
B	REDESIGNED	WH	2010/02	GA
C	OPTION 400 Added	WH	2010/09	LS
D	CORRECTED LABEL ON AC FEED	LM	2010/04	JK

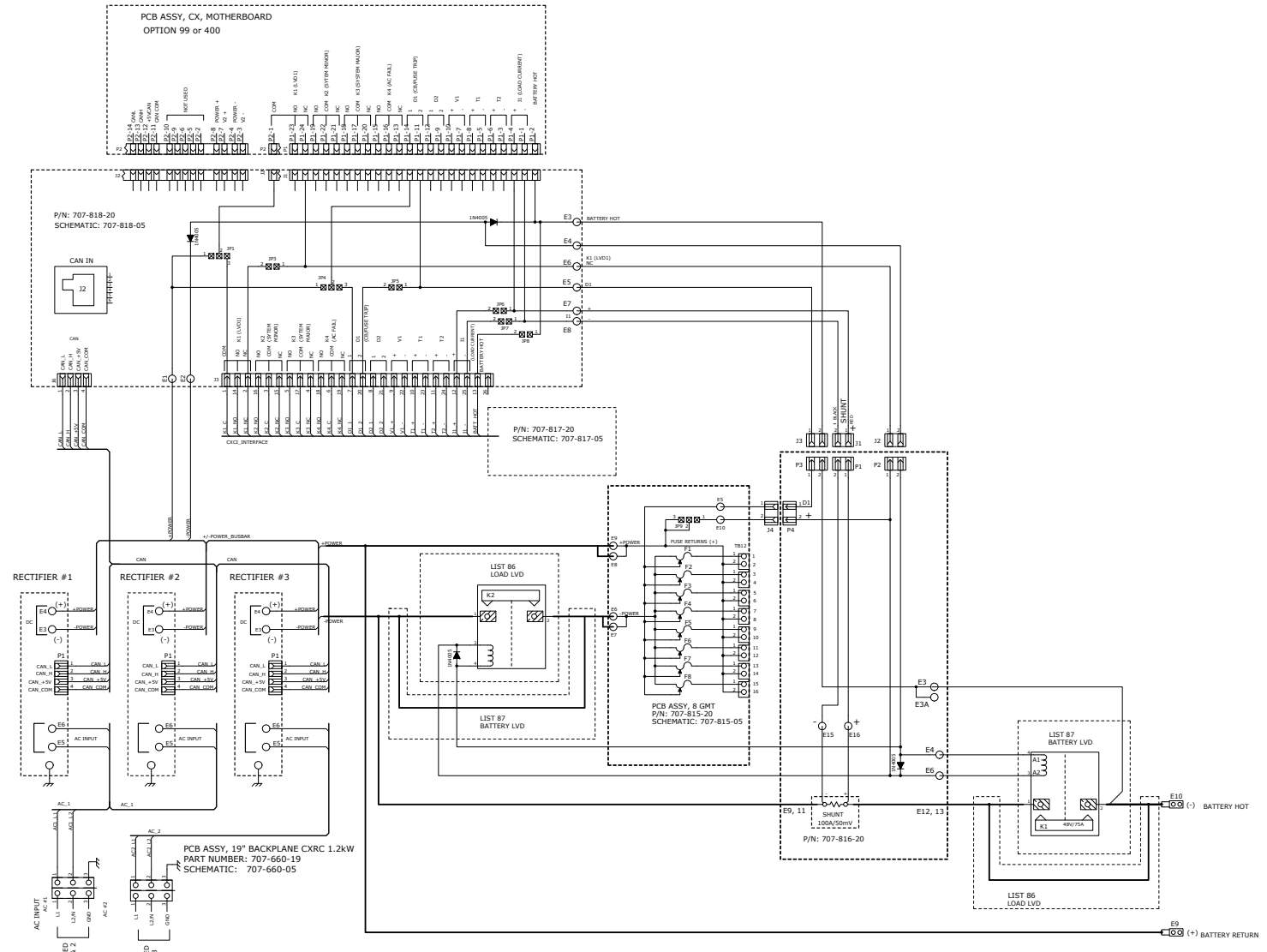

© ALPHA TECHNOLOGIES

THESE DESIGNS AND SPECIFICATIONS ARE CONFIDENTIAL. REMAIN THE PROPERTY OF ALPHA TECHNOLOGIES AND SHALL NOT BE COPIED OR USED WITHOUT ITS WRITTEN CONSENT.

DESIGN	WH	2010/02	CHECKED	MC	2010/02
DRAWN	WH	2010/02	APPROVED	GA	2010/02

TITLE: **SCHEMATIC, SHELF, 19\"/>

ISSUE	SHEET 1 of 1		
DATE	SIZE	DWG NO.	REV
	B	S3	030-851-05 D

DO NOT SCALE DRAWING

REVISIONS				
LTR	DESCRIPTION	DWN	DATE	CHK
B	OPTION 400 ADDED	WH	09-15-15	LS

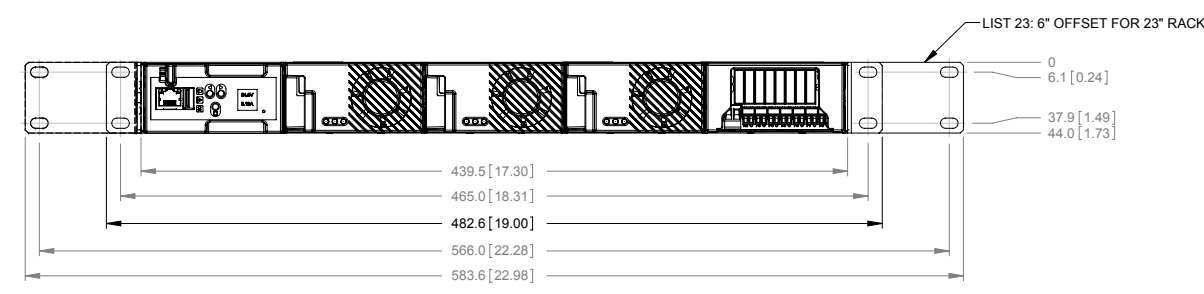
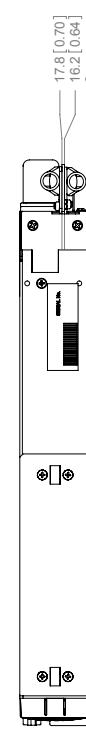
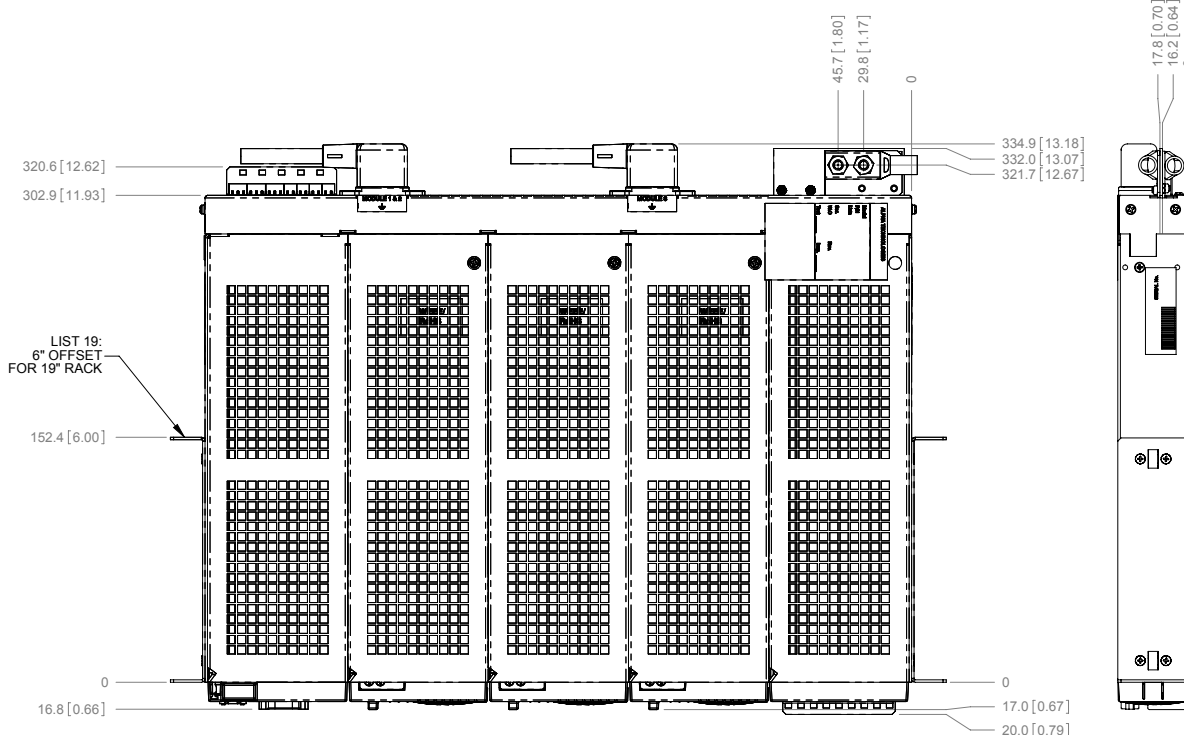
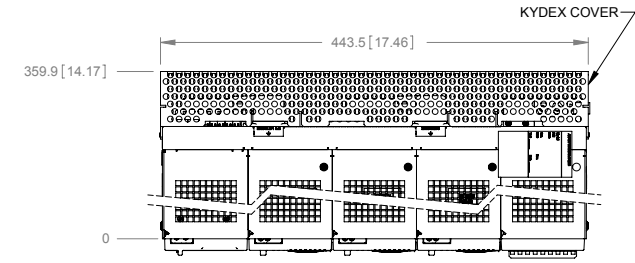
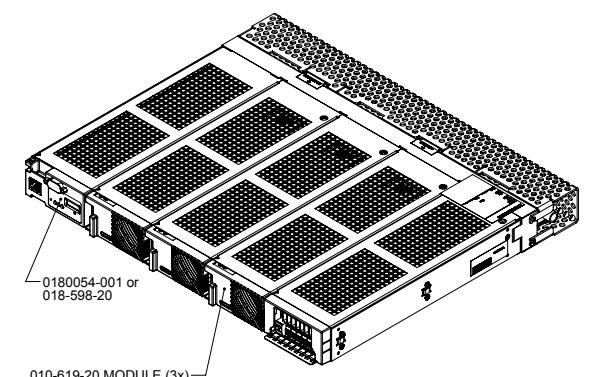

SCALE 1 : 3

THESE DESIGNS AND SPECIFICATIONS ARE CONFIDENTIAL. REMAIN THE PROPERTY OF ALPHA TECHNOLOGIES LTD. AND SHALL NOT BE COPIED OR USED WITHOUT ITS WRITTEN CONSENT



APPROVALS	DATE
DRAWN SY	03-10-10
CHECKED WH	03-22-05

TITLE: OUTL. DWG. ASSY SHELF 19" 1RU HOR, 3MDL,LVD,CXRF48-1.2kW

© ALPHA TECHNOLOGIES LTD

SIZE DWG NO. 030-851-06 REV B
SCALE: NTS SHEET 1 OF 1

5

4

3

2

1

DO NOT SCALE DRAWING

REVISIONS				
LTR	DESCRIPTION	DWN	DATE	CHK
B	OPTION 400 ADDAD			

BATTERY RETURN (+)

AC INPUTS (2 PLACES)
(SEE MANUAL FOR INSTALLATION INSTRUCTIONS)

CXCM1 INTERFACE
(SEE MANUAL FOR INSTRUCTIONS)

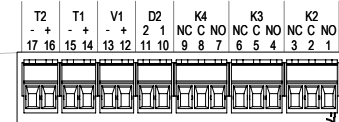

BATTERY HOT (-)

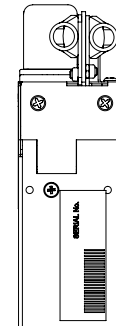
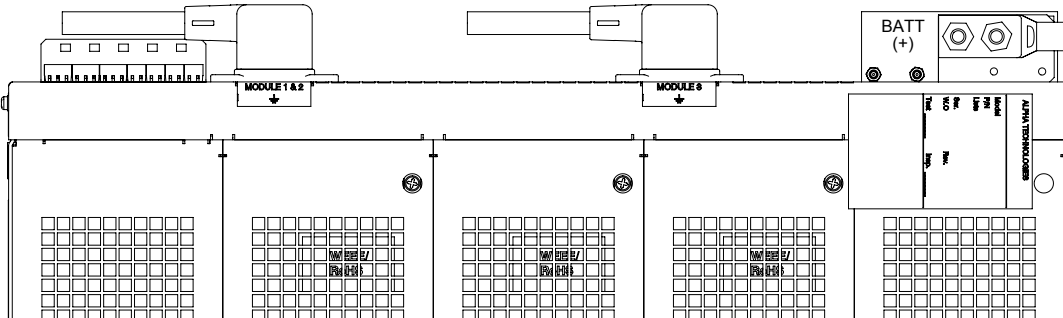
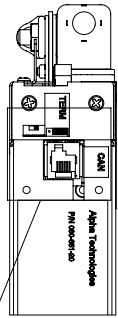

CAN TERMINATION

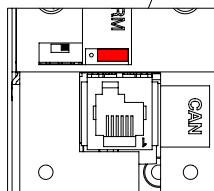

PIN	FUNCTION
1	CAN COM
2	CAN H
3	NOT CONNECTED
4	CAN L
5	NOT CONNECTED
6	CAN +5V

DETAIL C

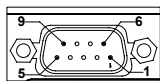

CAUTION!
USE ONLY ALPHA DC MODEM
(SEE MANUAL FOR INSTRUCTIONS)

PIN	FUNCTION
1	DCD
2	RX
3	TX
4	DTR
5	COM
6	DSR
7	RTS
8	CTS
9	RI

GMT FUSE DISTRIBUTION PANEL
MAX. 40 ADC
(SEE MANUAL FOR INSTRUCTIONS)

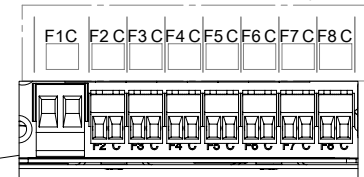

ETHERNET RJ45

PIN	FUNCTION
1	TX+
2	TX-
3	RX+
4	NOT CONNECTED
5	NOT CONNECTED
6	RX-
7	NOT CONNECTED
8	NOT CONNECTED

DETAIL B

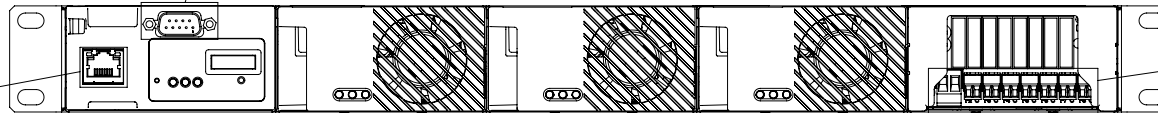

OPTION 400

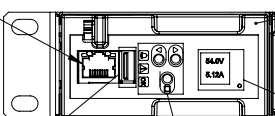

DETAIL G



RESET

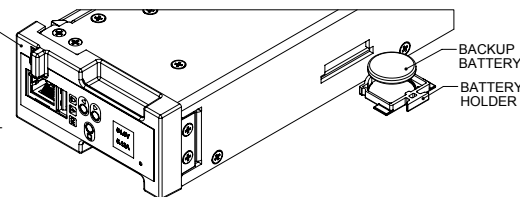

BACKUP BATTERY

BATTERY HOLDER

STATUS DISPLAY

MENU CONTROL

MENU SELECT/ BUTTON C

STATUS DISPLAY

DETAIL E

USB 2.0 PORT

DETAIL F

<small>THESE DESIGNS AND SPECIFICATIONS ARE CONFIDENTIAL. REMAIN THE PROPERTY OF ALPHA TECHNOLOGIES LTD. AND SHALL NOT BE COPIED OR USED WITHOUT ITS WRITTEN CONSENT</small>			TITLE: CUST.CONN. SHELF 19" 1RU HOR. MDL,LVD,CXRF48-1.2KW
APPROVALS DRAWN SY 3/15/2003 CHECKED WH 3/15/2003	DATE 3/15/2003		
© ALPHA TECHNOLOGIES LTD		SCALE: NTS	REV B DWG NO. 030-851-08 SHEET 1 OF 1

5

4

3

2

1



Worldwide Corporate Offices

Headquarter Germany

Hansastraße 8
D-91126 Schwabach
Tel: +49 9122 79889 0
Fax: +49 9122 79889 21
Mail: info@alpha-outback-energy.com

Eastern Europe

ee@alpha-outback-energy.com

France and Benelux

fbnl@alpha-outback-energy.com

Russia

russia@alpha-outback-energy.com

Middle East

me@alpha-outback-energy.com

Spain

spain@alpha-outback-energy.com

Africa

africa@alpha-outback-energy.com

Alpha and Outback Energy GmbH reserves the right to make changes to the products and information contained in this document without notice. Copyright © 2020 Alpha and Outback Energy GmbH. All Rights reserved.

For more information please visit www.alpha-outback-energy.com

010-619-J0 (07/2020)