

907X 50C



HASSELBLAD

| | | |
|----------|---|-----------|
| 1 | INTRODUCTION | 7 |
| 1.1 | 907X 50C | 8 |
| 1.2 | 907X 50C features | 9 |
| 1.3 | Included items | 12 |
| 1.4 | 907X 50C Technical specifications | 13 |
| 1.5 | System requirements | 15 |
| 1.6 | New in this version | 15 |
| 1.7 | About this user guide | 15 |
| 1.8 | Glossary | 16 |
| 1.9 | Update camera firmware | 16 |
| 2 | LENSES | 17 |
| 2.1 | XCD Lens Range | 18 |
| | XCD 4/21 | 18 |
| | XCD 3.5/30 | 18 |
| | XCD 3.5/45 | 18 |
| | XCD 4/45P | 18 |
| | XCD 2.8/65 | 18 |
| | XCD 1.9/80 | 19 |
| | XCD 3.2/90 | 19 |
| | XCD 3.5/120 Macro | 19 |
| | XCD 2.8/135 and X Converter 1.7 | 19 |
| | XCD 3,5-4,5/35-75 | 20 |
| | Filters | 20 |
| 3 | QUICK START | 21 |
| 3.1 | Quick start | 22 |
| | Firmware | 22 |
| | Assembling the camera | 22 |
| | Battery | 23 |
| | SD card | 23 |
| 3.2 | Charging the battery | 24 |
| | Battery charger | 24 |
| | Charge the battery | 24 |
| | Charging from the USB port | 24 |
| | Attach the lens | 25 |
| | Attach the shoulder strap | 26 |
| | Using the protective covers | 27 |
| | The First capture | 28 |
| | The First capture - continued | 29 |
| | Viewing the first capture on the computer | 30 |

| | | |
|----------|--|-----------|
| 4 | SAFETY | 31 |
| 4.1 | Safety and Warnings | 32 |
| 4.2 | Cautions | 32 |
| 4.3 | Disposal | 33 |
| 4.4 | FCC | 34 |
| 4.5 | ISED | 34 |
| 5 | PARTS & CONTROLS | 35 |
| 5.1 | Parts, components, buttons and controls | 36 |
| 5.2 | Ports and connections | 42 |
| 5.3 | Display and screens | 43 |
| | Tilt display | 43 |
| 6 | USING THE 907X | 44 |
| 6.1 | Touch display | 45 |
| | Touch display navigation | 45 |
| | Available screens | 46 |
| 6.2 | Touch display main menu | 47 |
| | Main Menu | 47 |
| | Add shortcuts to main menu favourites | 47 |
| | How to add shortcuts to main menu | 48 |
| | How to remove shortcuts on the main menu | 48 |
| | How to move shortcuts on the main menu | 48 |
| | Control screen | 49 |
| | Locked exposure parameters on the control screen | 50 |
| | Settings on the control screen | 51 |
| | Self Timer settings | 57 |
| | Interval settings | 58 |
| | Interval operation | 59 |
| | Exposure bracketing settings | 60 |
| | Exposure bracketing operation | 61 |
| | Long exposure screen | 61 |
| | Focus Bracketing | 62 |
| | Focus Bracketing settings | 63 |
| | Focus Bracketing Operation | 64 |
| | Step Size | 65 |
| | DoF and Step size visualized | 66 |
| | Examples | 67 |
| | Fixed exposure compensation setting | 68 |
| | Light meter mode | 69 |
| 6.3 | Memory cards | 70 |
| | Insert the SD memory card | 71 |

| | | |
|----------|---------------------------------|-----------|
| | Remove the SD memory card | 71 |
| | Recommended memory cards | 71 |
| | Format SD cards | 72 |
| 6.4 | Live view indications | 73 |
| | Live view overlays | 74 |
| | Zooming in live view | 74 |
| | Live view Settings | 75 |
| 6.5 | Focusing | 76 |
| | Autofocus | 76 |
| | AF indications | 77 |
| | Manual focus | 78 |
| | Focus peaking | 79 |
| 6.6 | Move autofocus point | 80 |
| 6.7 | Resize autofocus point | 80 |
| | Menu screen navigation | 81 |
| 6.8 | Browsing, preview and histogram | 83 |
| | Browsing images | 83 |
| | Zooming | 84 |
| | Browsing images - nine-view | 84 |
| | Select folder to browse | 85 |
| | Select card to browse | 85 |
| | Create new folder | 86 |
| | Delete images | 87 |
| | Browse overlays | 88 |
| | Histograms | 89 |
| 6.9 | Image Rating | 90 |
| | Rating Function | 90 |
| 6.10 | Video Recording | 91 |
| | How To Record Video | 91 |
| | How to View Recorded Video | 92 |
| 7 | 907X CONTROL GRIP | 93 |
| 7.1 | 907X Control Grip | 94 |
| | Parts and Controls | 94 |
| | Attaching the Control Grip | 95 |
| | Using the Control Grip | 96 |
| | Joystick | 97 |
| 8 | 907X OPTICAL VIEWFINDER | 99 |
| 8.1 | 907X Optical Viewfinder | 100 |
| | Attaching to the camera | 100 |
| | OVF Markings | 101 |

| | | |
|-----------|--|------------|
| 9 | PHOCUS | 102 |
| 9.1 | Phocus overview | 103 |
| | Phocus | 103 |
| | Features in Phocus | 104 |
| | Phocus Mobile 2 | 105 |
| 9.2 | Connect to a computer | 106 |
| 9.3 | Connect to an iPad pro | 106 |
| | Using cable | 106 |
| | Using Wi-Fi | 106 |
| 9.4 | Connect the Camera to an iPad Pro over Wi-Fi | 107 |
| | Bluetooth assisted Wi-Fi connection | 107 |
| | Manual Wi-Fi connection | 108 |
| 9.5 | Phocus and Hasselblad capture files | 109 |
| 10 | SETTINGS | 110 |
| 10.1 | The camera settings menu | 111 |
| | Exposure | 111 |
| | Increment settings | 112 |
| | Shutter function settings | 113 |
| | True Exposure explained | 114 |
| | AE-L (AE-Lock) / Quick Adjust | 115 |
| | Auto ISO / P / Full Auto | 116 |
| | Crop & Orientation | 117 |
| | Image orientation | 118 |
| | Image quality settings | 119 |
| | Focus settings | 120 |
| | Flash settings | 123 |
| | Camera configuration settings | 124 |
| 10.2 | Video settings menu | 126 |
| 10.3 | General settings menu | 128 |
| | Connectivity settings | 129 |
| | Display | 130 |
| | Live view | 131 |
| | Preview | 132 |
| | Touch | 133 |
| | Custom Buttons | 134 |
| | Storage | 135 |
| | How to format a memory card | 136 |
| | Sound | 137 |
| | Date & Time | 138 |
| | Power | 139 |
| | Spirit Level | 140 |

| | |
|------------------------|-----|
| Calibrate Spirit Level | 141 |
| Language | 142 |
| Service | 143 |
| Firmware update | 144 |
| Lens firmware update | 145 |
| Log data | 146 |
| Default settings | 147 |
| Reset file counter | 148 |
| About | 149 |

1 1 ACCESSORIES 1 50

| | |
|------------------------|-----|
| XH Lens adapter | 151 |
| XV Lens adapter | 151 |
| Tripod mount ring 75mm | 151 |
| XPan Lens adapter | 152 |
| Release cord X | 152 |
| Battery charging hub | 152 |

1 2 APPENDIX 1 53

| | | |
|------|---------------------------------------|-----|
| 12.1 | Change from a foreign language | 154 |
| 12.2 | Clean the sensor filter | 155 |
| 12.3 | Clean the lens glass surface | 155 |
| | Remove dust | 155 |
| | Remove smear | 155 |
| 12.4 | Error messages | 156 |
| 12.5 | Information about the 907X user guide | 156 |
| | Updates | 156 |
| | 3D product images | 156 |
| | Trademarks | 156 |
| | Copyright | 156 |

1.1 907X 50C

With the CFV II 50C digital back and the 907X camera body, Hasselblad's photographic history is connected in one system. Bridge the past and the present with the modernised CFV II 50C attached to a classic Hasselblad V System camera. Merge the CFV II 50C with the 907X to create a whole new combination that enables shooting with a variety of Hassel-

blad optics, ranging from the V System, H and XPan lenses to our latest XCD lens range.

This User Guide describes the functionality of the 907X 50C Camera. A separate User Guide is available that explains how to use the CFV II 50C on V System and Technical Cameras.



Reminiscent of the classic V System camera combined with Hasselblad's high-end digital medium format technology, the 907X camera offers a truly distinct photographic experience. Small and compact, it produces unparalleled medium format image quality. The CFV II 50C's tilt screen enables the classic waist-level shooting style of the V System, hinting to Hasselblad's history while letting photographers compose their images from a new point of view in the digital era.

1.2 907X 50C FEATURES

Full XCD Lens support

All XCD Lenses can be fully used with the same functionality as on an X System Camera, including Autofocus.

HC/HCD Lens support

All HC and HCD Lenses can be used with full functionality, including Autofocus using the optional XH Lens Adapter.

V System and XPan System lenses

All Lenses from the Hasselblad V and XPan Systems can be used in electronic shutter mode. Requires optional XV or XPan Lens adapters.

3rd Party Lens support

By using lens adapters from 3rd party manufacturers, almost all other lenses can be used in electronic shutter mode on the 907X camera.



V System Camera support

The CFV II 50C digital back can be removed from the 907X camera body and be used on most V System Cameras ever built. See the separate User Guide for the CFV II 50C for more information.

Touch screen interface

Equipped with a smartphone style user interface, the rear touch 3.3 inch display allows quick and simple access to the digital back shooting settings including WB and ISO. There is also the option of adding up to 8 favourite icons to the main menu display to allow fast access to your most frequently used functions and settings.

Tilt screen

The rear screen can be tilted upwards 90 degrees for convenient operation in many situations.

Live view

High frame rate live view is available to assist with critical focusing of the image.

Dual SD media card slots

Equipped with dual UHS-II compatible media card slots, the digital back will automatically use them concurrently for storage.

Battery inside

Improving on previous CFV models, the interchangeable and rechargeable battery is now located inside the CFV, behind the SD card lid. This enables the streamlined shape and design to be maintained and makes it possible to adapt to basically all V System cameras ever made. Battery type is the same that is used for X System cameras.



USB 3 Type C

Simplifying and enhancing tethered shooting to your Mac or PC, the USB 3 interface allows easy connectivity with today's high speed ports.

Built-in Wi-Fi

The Wi-Fi function uses both 2.4 and 5 GHz and has the option of 802.11 b, g, n, a, ac (a and ac depending on region) connections. A separate App for iOS, Phocus Mobile 2 is available for download from the Apple App Store.

Huge 14 stop dynamic range

Makes it easier to keep details in both deep shadows and bright highlights. It will also allow fantastic HDR images to be assembled from less captures.

Large 43.8 x 32.9mm 50MP sensor

For amazing image resolution with low image noise, enabling enlargements in breathtaking quality.

Shallow depth of field

The larger size of the sensor delivers a shallower depth of field with a given focal length compared to a Full Frame 35mm camera enabling easier separation of your subject from the background and super smooth Bokeh with Hasselblad lenses delivering the classic "medium format look" to your images.

HNCS Hasselblad Natural Colour Solution

HNCS saves time and enables high colour accuracy. Especially important with skin tones and specific product tones that now are going to be perfectly rendered.

JPEG & RAW files

The JPEG files are HNC profiled so you can print straight from a folder for amazing quality. RAW files are retained for your final masterpieces.

Digital lens corrections

The Digital lens correction, which is applied at the file editing stage, takes care of any colour aberration, distortion and light fall off however minor (which is inherent in any lens, anywhere) and resolves the situation automatically.

Hasselblad Phocus digital imaging software

The Hasselblad Phocus Digital imaging software is a capture, processing and file management application aimed primarily at Hasselblad RAW file handling. The desktop version is compatible with both Mac and PC and is a free download from www.hasselblad.com.

Hasselblad Phocus Mobile 2 app for iOS

Use the iPad Pro to edit images directly from the camera. Phocus Mobile 2 offers remote viewing and control when shooting tethered (Wi-Fi or USB cable). Phocus mobile 2 is free to download at Apple's App Store for the iPad Pro. The 907X camera is not compatible with the previous version of Phocus Mobile.

1.3 INCLUDED ITEMS

The 907X 50C camera is delivered with the following items.

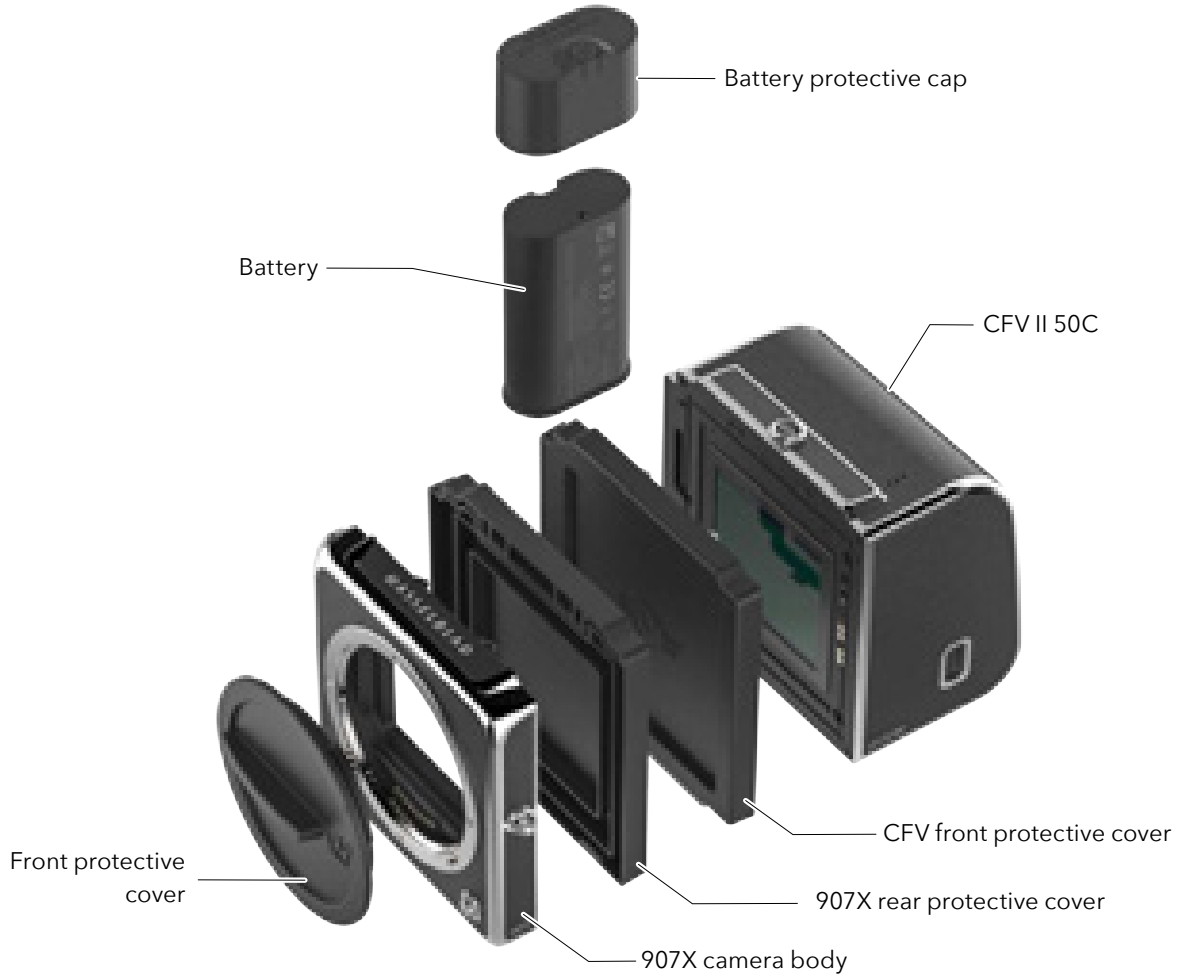

Flash sync input cable



Flash sync output cable



Exposure cable CW



Focusing screen mask
44x33mm



USB A to C cable, 80cm



USB charger

- Shoulder strap
- Quick Start guide
- In the box
- Warranty leaflet
- Disclaimer and safety guidelines
- Registration card

1.4 907X 50C TECHNICAL SPECIFICATIONS

| | |
|------------------------|---|
| Camera Type | Medium Format Mirrorless Digital camera with Autofocus, Auto exposure and interchangeable lenses. |
| Construction | Machined aluminium. Tripod socket 1/4". |
| Sensor Type | CMOS, 50 megapixels (8272 × 6200 pixels, 5.3 × 5.3 µm). |
| Sensor Dimensions | 43.8 × 32.9 mm. |
| Image Size | Stills: 3FR RAW capture 106 MB on average. JPEG: Up to 22 MB, TIFF 8 bit: 154 MB. Video: 2.7K (2720 x 1530) and HD (1920 x 1080), max 29:59 minutes/clip). Video covers the full sensor width in a 16:9 ratio. |
| File Format | Hasselblad 3FR RAW, Full size JPEG. Video: H.264 Compressed (29,97 fps). |
| Shooting Mode | Single shot and Video, Continuous, Self Timer, Interval Timer, Exposure Bracketing and Focus Bracketing. |
| Colour Definition | 16-bit; Dynamic range up to 14 stops. |
| ISO Speed Range | ISO Auto, 100, 200, 400, 800, 1600, 3200, 6400, 12800, 25600. |
| Storage Options | Dual UHS-II SD cards or tethered to Mac or PC. Max 1 TB. SD Cards can be used in Overflow or Backup (images only) mode. Recommended cards are listed on page 71. |
| Colour Management | Hasselblad Natural Colour Solution (HNCS). |
| Storage Capacity | A 64 GB card holds approximately 600 RAW or 6000 JPEG High Quality images on average. |
| User Interface | Touch interface including swipe, scroll and pinch/spread to zoom. Camera grip with buttons and Scroll Wheels. Many camera functions and settings can be controlled from a tethered computer or iPad Pro/iPad Air (2019) over Wi-Fi or tethered. |
| Display | 3.2 inch TFT type, 24 bit colour, 2.36 M dots (1024 x 768). Can be tilted up to 90 degrees. |
| Live View | On camera and host computer with high frame rate. |
| Histogram Feedback | Yes, in Browse Mode on rear display. |
| IR Filter | Mounted in front of sensor. |
| Acoustic Feedback | Yes. |
| Software | Phocus for Mac and Windows. Compatible with Adobe Photoshop Lightroom® and Adobe Camera Raw®. Phocus Mobile 2 for iPad Pro and iPad Air (2019). |
| Platform Support | Macintosh: OS X version 10.12.2 or later. PC: XP/Vista/Windows 7 (32 and 64 bit)/ 8 / 10. |
| iOS device Support | iPad Pro or iPad Air (2019 or later). |
| Host Connection Type | USB 3.0 (5 Gbit/s) Type-C connector. |
| Additional Connections | Audio In/Out. |
| Operating Temperature | -10 to 45 °C. 14 to 113 °F. |
| Wi-Fi | 802.11 b, g, n, a, ac (a and ac depending on region). |

Continued on the next page.

907X 50C TECHNICAL SPECIFICATIONS – CONTINUED

| | |
|---------------------|---|
| Lenses | Hasselblad XCD lenses with built in electronically controlled shutter and aperture. Automatic or manual focusing with instant manual focus override. Lens shades can be mounted in reverse for transport. Compatible with all H System lenses and some H System accessories using an XH Lens Adapter. Also compatible with V System and XPan Lenses using a XV or XPan Lens Adapter. Many other lenses via 3rd party lens adapters (E-shutter only). |
| Shutter | Electronically controlled lens shutter with speeds up to 1/2000 s. Flash sync at all speeds. Optional electronic shutter. |
| Shutter Speed Range | 68 minutes to 1/2000 s with XCD Lenses. 1/800 s or 1/2000 s with HC/HCD Lenses. Electronic shutter 68 min to 1/10000 s. |
| Flash Sync Speed | Flash can be used at all shutter speeds. Mechanical shutter only. |
| Flash Compatibility | Socket for connection of external flashes via included sync cable. |
| Focusing | Automatic and manual focusing. Instant manual focus override. Automatic focusing using contrast detection. 100% zoom or Focus Peaking available in manual focus. Up to 117 selectable autofocus points. |
| Exposure Metering | Spot, centre weighted and centre spot. |
| Power Supply | Rechargeable Li-ion battery (7.27 VDC/3400 mAh). Compatible with the 3200 mAh battery. Can be charged in camera via USB or with optional external charger. Plug for external DC Power. |
| Dimensions | 907X + CFV II 50C: 102 × 93 × 84 mm, 907X only: 102 × 91 × 28 mm, CFV II 50C only: 91 × 93 × 61 mm. |
| Weight | 740 g (CFV II 50C: 540 g / 907X Camera Body: 200 g). Excluding battery and SD card. |

1.5 SYSTEM REQUIREMENTS

Storage and editing of images requires certain minimum computer capabilities. Large images require a reasonably high performance computer with sufficient memory, advanced graphics capabilities and a recent operating system. It is recommended that the computer has a USB 3 connector, which will allow you to load images more quickly from the camera. A USB SD card reader is also required for image transfer from the SD cards.

1.6 NEW IN THIS VERSION

This is the first version of this User Guide. It describes the functionality available with CFV II 50C firmware version 1.3.0 or later.

1.7 ABOUT THIS USER GUIDE

This User Guide is designed for on-screen PDF reading to take advantage of the interactivity functions and search tools.

Interactive PDF

You can navigate the user guide by selecting a chapter in the Table of Contents. This interactive feature is available on nearly all PDF readers, computer platforms and web browsers. All pages contain a link back to the Table of Content and most page references also work as a click-able link.

Search Tools

On most PDF readers you can use the search tool to find a specific subject, function or setting.

Format and Printing the User Guide

Please note that the format is A4 to conform with the most common standard. Therefore if printing to US Letter format or similar please ensure you select "Fit to Printable Area" in the page scaling dialogue.

Photo Credits

Mattias Hammar: 67 and 121
 Mads Selvig: 16, 103, 104, 105 and 106
 Philip Liljenberg: 124
 Jens Karlsson: 85
 Ian Lawson: 46 and 90



1.8 GLOSSARY

In this user guide a few different terms are used:

Short-Press: Press and release a button within one second.

Long-Press: Press and hold a button for 1 second or more.

Tap: This means to touch a value or icon on the display with your finger briefly. This only works with a bare finger or when special touch-display gloves are used.

Double-Tap: Quickly tap the same location on the display within 1 second. This is mainly used to zoom in an image or Live View.

Swipe: A sliding movement is when you press and hold the finger and slide in one direction. This is typically used when selecting a value from a list or when panning in a zoomed-in image.

Spread: Place two fingers on the display and move them apart. Typically used for zoom in.

Pinch: Place two fingers on the display with a distance between and move the fingers together. Typically used when zooming out.

Tethering: When the Camera is connected with a USB cable to a computer.

1.9 UPDATE CAMERA FIRMWARE

The Camera can be updated with improvements and new functions.

Before you start to use your new camera, please visit www.hasselblad.com and download the latest camera firmware and update the camera system to make sure you get the latest functionality. Also make sure to download the latest version of this user guide.

See page 144 for an in-depth description on how to download the camera firmware and update your camera.



2.1 XCD LENS RANGE



XCD 4/21

The XCD 21 is the ultra wide-angle lens. Its extremely short focal length provides a 17 mm full frame equivalent lens, making it perfect for landscape and architecture photography.



XCD 3.5/30

The XCD 30 is a wide-angle lens. Its focal length provides a 24 mm equivalent field of view, making it the perfect landscape, reportage and travel lens.



XCD 3.5/45

The XCD 45 is the ideal standard lens. Its moderate wide-angle focal length provides a 35 mm equivalent field of view, making it the perfect general purpose lens.

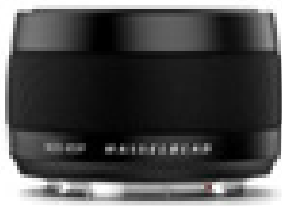

XCD 4/45P

The XCD 45P is a highly compact lens. Its focal length provides a 35 mm equivalent field of view, making it a perfect general purpose and travel lens.



XCD 2.8/65

The XCD 65 mm is a normal lens. Its focal length provides a 50 mm equivalent field of view. Its high aperture and excellent close-range performance makes it perfect for general type of photography as well as for reproduction.



XCD 1.9/80

The XCD 80 is a high-aperture lens, providing very short depth-of-field with beautiful Bokeh, especially useful for available light portrait photography. It has a 63 mm equivalent field of view.



XCD 3.2/90

The XCD 90 is a light and compact short telephoto lens. Its moderate focal length provides a 71 mm equivalent field of view, making it a perfect all-round lens.



XCD 3.5/120 MACRO

The XCD 120 is the ideal macro lens. It is suitable for both close-up work and for portrait or other photography requiring a longer focal length. Focuses down to an image scale of 1:2. It has a 95 mm equivalent field of view.



XCD 2.8/135 AND X CONVERTER 1.7

The XCD 135 is a moderate telephoto lens with a dedicated 1.7x converter, providing a 4.8/230mm lens. 35 mm equivalent focal lengths are 107 and 181 mm.



XCD 3,5-4,5/35-75

This Zoom lens is ideal for photographers who are looking to keep the amount of equipment they carry when travelling to a minimum but don't want to compromise on image quality. Focuses down to 0.42m (W) / 0.6m (T). It has a 28-58 mm equivalent field of view.

FILTERS

The XCD Lenses have a threaded filter mount with diameter as shown in the table to the right.

As there is no rotation of the front section of the lens when the focus is changed, the filter do not rotate either. This is particularly useful when using polarizing or graduated filters where the orientation is critical.

| LENS | FILTER DIAMETER |
|---------------|-----------------|
| XCD 21 | ø 77mm |
| XCD 30 | ø 77mm |
| XCD 45 | ø 67mm |
| XCD 45P | ø 62mm |
| XCD 65 | ø 67mm |
| XCD 80 | ø 77mm |
| XCD 90 | ø 67mm |
| XCD 120 Macro | ø 77mm |
| XCD 135 | ø 77mm |
| XCD 35-75 | ø 77mm |

3.1 QUICK START

This chapter explains how to make the first capture using the default settings.

FIRMWARE

Make sure the camera has the latest firmware by checking the latest version that you can download at www.hasselblad.com. You can see the currently installed firmware by following the procedure on page 149. Instructions on how to update firmware can be found on page 144.

Note!

Make sure the CFV II is powered off before attaching the 907X camera body.

ASSEMBLING THE CAMERA

- 1 Remove the rear protective cover of the 907X camera body by pressing on the top part **(A)** and then swinging the cover backwards **(B)**.
- 2 Remove the front protective cover of the CFV II 50C by sliding the lock button **(C)** in the direction of the arrow and then swinging the cover outwards **(D)**.
- 3 Attach the CFV II 50C to the 907X by placing the CFV II onto the lower supports on the 907X **(E)**.
- 4 Swing the CFV II towards the camera while holding the lock button on the open position **(F)**.
- 5 When the CFV II is attached to the camera, release the lock button **(G)** and make sure the CFV II is securely attached to the 907X by pushing it in the direction of the arrow.



BATTERY

Make sure the battery is fully charged. See more on the next page. Open the right side lid by sliding it backwards **(A)** and insert the battery with the text facing backwards into the CFV until it clicks in place. **(B)**

Note!

When the battery is inserted, the rear status LED will show a blink sequence once to indicate the current battery charge level. See next page for details.

Note!

The first time you use the camera after unboxing, please remove the plastic **(1)** tab on the battery before re-inserting.



Note!

If the camera doesn't start up when a new battery is inserted, connect the camera via USB to a computer or a charger. You can also remove the battery and place it in the optional Charging Hub accessory.

SD CARD

Insert the SD card into slot 1 or 2. The contact side of the card shall be facing towards the rear display **(C)**.

Close the lid by swinging it back and sliding it forward.

For best results, the card should be formatted in the camera by using the procedure on page 72.

For recommended memory cards, see page 71.



3.2 CHARGING THE BATTERY

BATTERY CHARGER

The camera is supplied with a USB power adapter for charging the camera battery through the USB port of the camera.

CHARGE THE BATTERY

Turn off the camera and insert the USB-C plug from the battery charger into the USB socket on the camera **(A)**. Insert the battery charger into a standard (100–240V~ /50–60 Hz) domestic socket.





CHARGING FROM THE USB PORT

When the battery is charging, the Status Led **(B)** indicates the current charge level by blinking with Orange color. See illustration to the right. E.g. if the battery has about 50% charge level, the LED will blink two times and then be turned off for a short period. The blinking sequence is repeated.



See also Battery Charging Hub accessory on page 152.



-  One blink = 0% to 25%.
-  Two blinks = 26% to 50%.
-  Three blinks = 51% to 75%.
-  Four blinks = 76% to 95%.
-  Steady light, 4 sec. = 95% to 100%



ATTACH THE LENS

- First remove the lens rear protective cap by rotating counter clock-wise **(A)**. Then remove the front protective cover **(B)** of the camera by pressing the lens release button **(C)** and rotating the cover counter-clockwise.
- Align the red index on the lens **(D)** with the index on the camera **(E)** and insert the lens. Rotate the lens clockwise until it clicks into place **(F)**.
- Remove the front protective cap by pinching the two buttons together **(F)**.

Note!

In order to collect as little dust as possible on the sensor, we recommend that you perform lens change in an as dust-free environment as possible. Try to make the lens change with the sensor facing down.

You can use a soft dust brush or compressed air to remove dust. Also see page 155.



ATTACH THE SHOULDER STRAP

Attach the included shoulder strap to the camera by following these instructions:

- A** Hold or place the camera with the lens pointing down and one of the strap lugs facing you. Attach the leather end **(1)** of the strap to the metal strap lug **(2)**.
- B** Open the metal ring **(3)** with a sharp tool. E.g. a screwdriver or a small knife. Be careful not to scratch the camera.
- C** Insert the open end of the metal ring into the hole of the strap lug. Rotate the ring one full turn and make sure it is fully attached to the strap lug.
- D** Finally, slide the plastic fastener **(4)** down.

Repeat the process for the other side of the camera.

Note!

If the strap is exposed to strong pulling force there is a risk that the metal rings or the strap itself can be damaged. Regularly check the condition and replace the rings or the entire strap if necessary.

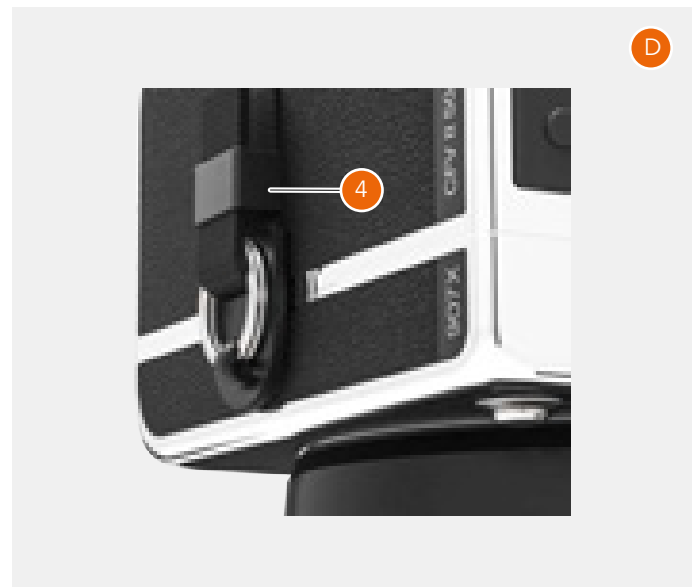
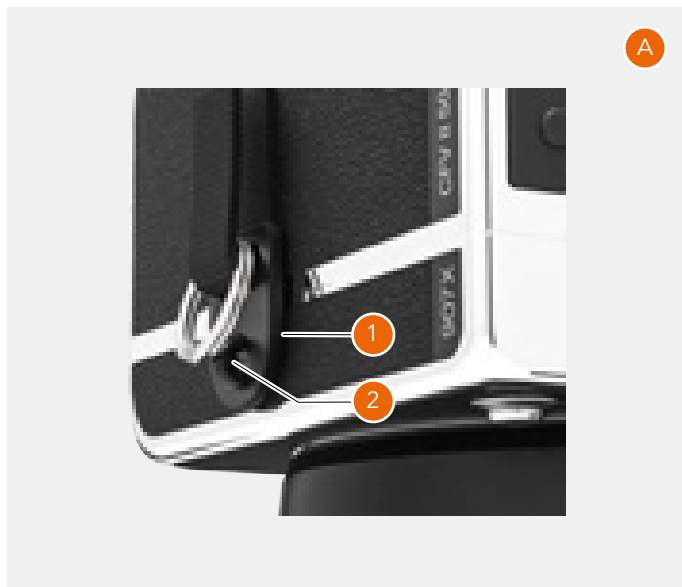
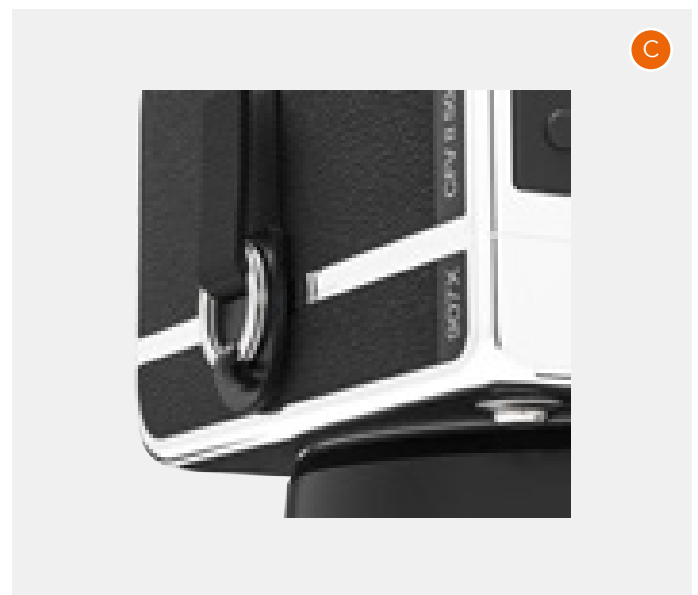
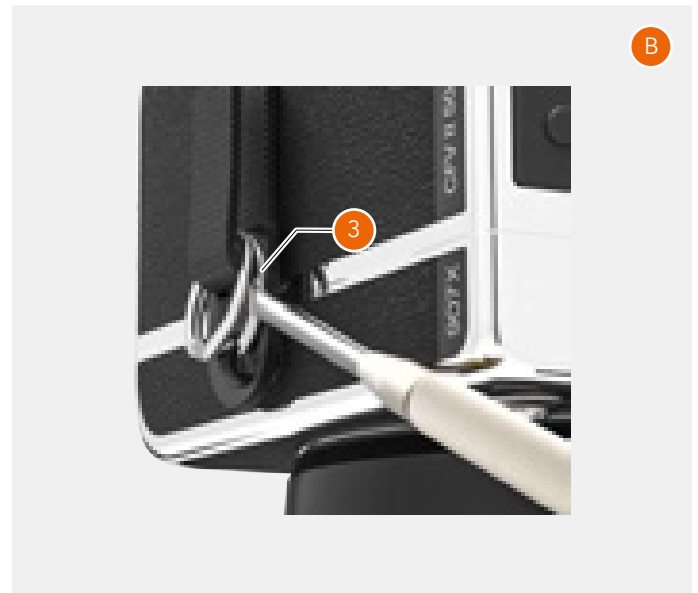

USING THE PROTECTIVE COVERS

Whenever the lens is removed from the camera or the 907X camera body is separated from the CFV II, protective covers should be used. The front protective cover is explained on page 25.

Camera rear protective cover

To remove:

Press the top part **(A)** down and tilt the cover backwards to release it.

To attach:

Place the cover on the lower supports **(B)** and press the top part **(A)** while tilting forward. Release pressure on the top part.

CFV protective cover

To remove:

Slide the locking button **(C)** in the direction of the arrow **(E)** and tilt the cover forwards to release.

To attach:

Place the CFV on the lower supports **(D)** and slide the locking button in the direction of the arrow **(E)**. Tilt the cover inwards until it locks.



THE FIRST CAPTURE

Press and hold the power button **(1)** for one second to turn the camera on. When the status LED **(2)** has turned green it is ready to make the first capture.

Gently press the shutter release (half-press) to activate live view on the screen. With the default setting, the camera is in Aperture priority mode indicated by an "A" at the lower left part of the display. Use the control wheel to select another aperture if required. Aperture and shutter speed are indicated at the bottom of the live view screen **(A)**

Aim the camera at the subject. The rectangle in the center of the image is the active area for Autofocus (AF). Half-press again to focus. Keep the button at half-press and re-compose if necessary and press the shutter release all the way to make the capture. The image will appear on the screen within a few seconds.

The default ISO is 100. Use the following steps and to set a different value:

- If the display is not already activate, press any of the rear buttons.
- Place your finger at the top of the screen and slide down to reveal the control screen **(A)**. You can do this from any screen.
- Tap the ISO value in the top right area **(B)**. Scroll through the list of ISO values by sliding up/down and tap the required value **(C)** to confirm the new ISO value

Note!

From the control screen you can also change white balance by tapping the white balance icon in the top left corner.

See more on page 51.

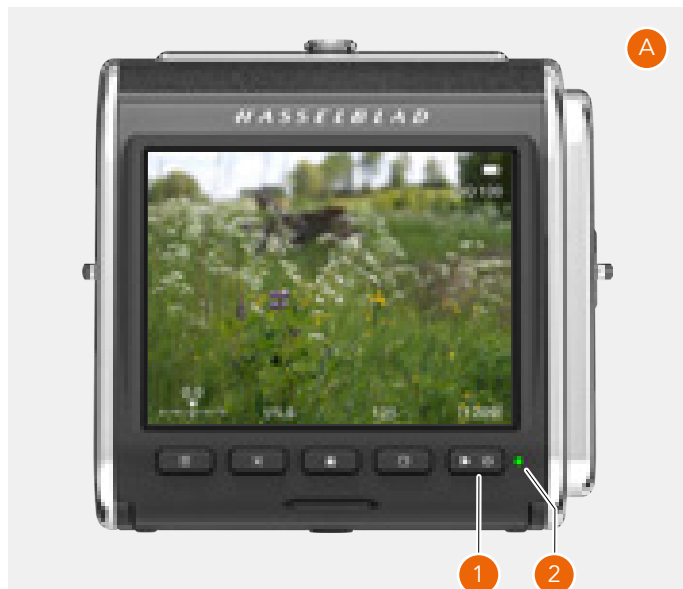

THE FIRST CAPTURE – CONTINUED

The camera is now fully ready to make captures. Half-press the shutter release **(1)** to activate live view.

To select a different aperture value, turn the control wheel **(2)**. When the exposure mode is set to A, the camera will automatically adjust the shutter speed to match the new value.

Aim the camera and compose the subject. When you half-press again, the camera will autofocus on the area inside the central rectangle **(3)**.

Finally, press the shutter release fully to make the capture. The captured image is now shown on the display where you can zoom and pan by swiping to examine details.

See more on page 84.



VIEWING THE FIRST CAPTURE ON THE COMPUTER

To view the image/images on the computer, you will first need to take the SD card from the camera and place it in an SD card reader. For best performance, you should use a USB-3 version of the card reader.

Note! Do not remove the card from the camera while the status LED is blinking.

The default setting of the camera is to store RAW images. It can be changed to store both RAW and Jpeg or Jpeg only.

To use the RAW file, follow the procedure below.

The next steps assume that you have installed Phocus on your computer. Phocus is available as a free download from www.hasselblad.com. Here you can also find a dedicated user guide for Phocus.

- 1 Start Phocus.
- 2 Connect the card reader to the computer and insert the card.
- 3 After a few seconds, the image/images will appear in the lower program panel **(A)**.
- 4 To be able to view the image in the large viewer window, it must first be imported. Click on the image to import and then click the "Import" icon  in the top panel **(B)**.
- 5 In the dialogue that appears, select a folder for the imported RAW file **(C)**.
- 6 Finally click on "Import" **(D)**.
- 7 After a few seconds, the image will appear in the main Viewer Window **(E)** and you can use all the tools to change the look as you like. Please study the separate Phocus user guide for more information.

Note!

Alternatively, you can also use Adobe Photoshop Lightroom or Adobe Photoshop to directly open the images from the card.

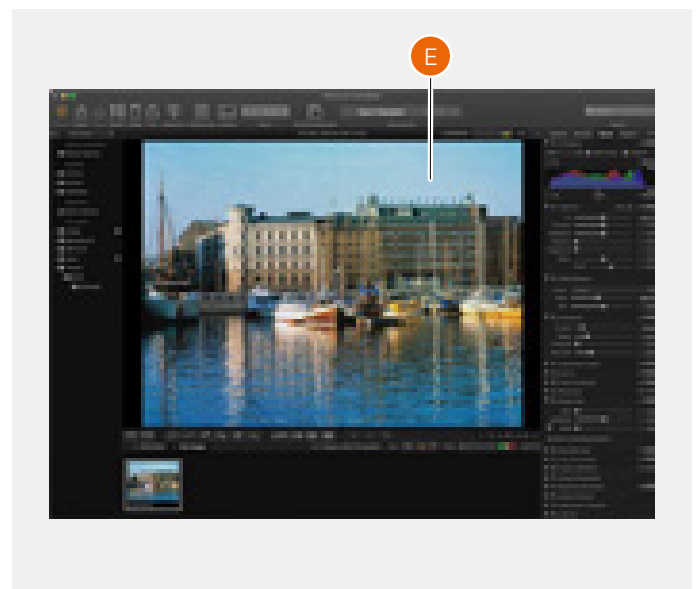
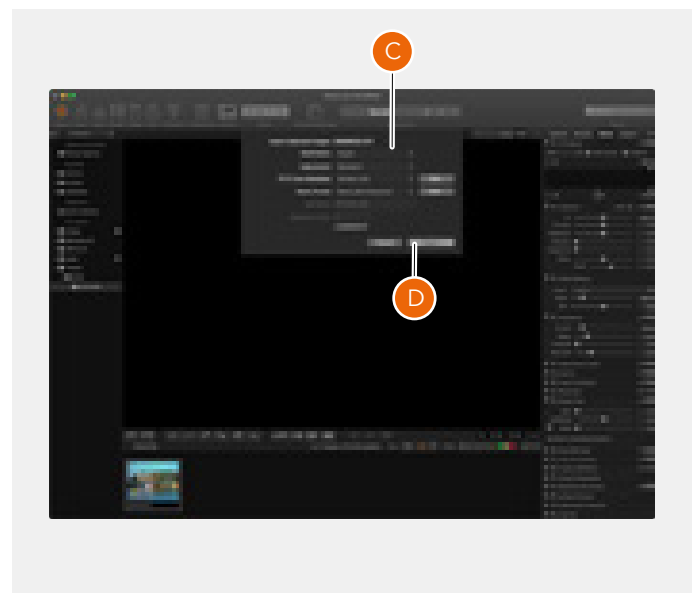
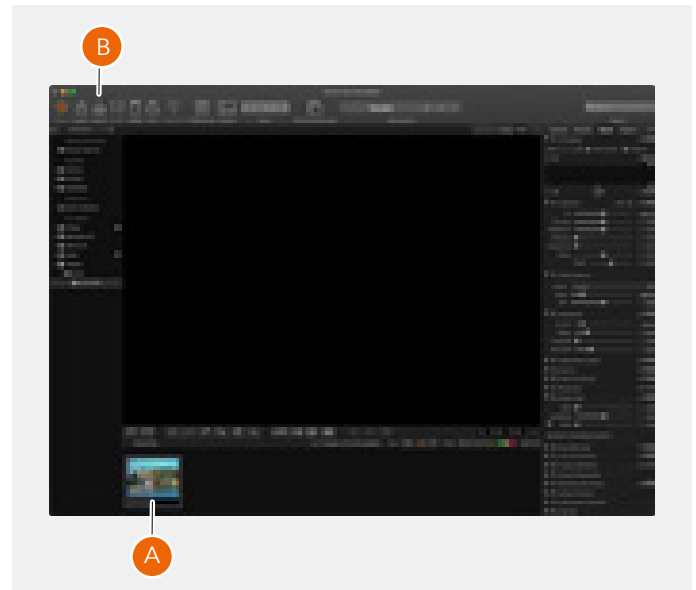

4.1 SAFETY AND WARNINGS

Warning!

Do not place cables between camera and computer so that there is a risk for people to trip and fall. This can cause personal injury and/or damage to the equipment.

Warning!

If you use spare battery packs, make sure to use protective caps on the contacts. The contacts can short circuit and catch fire, if not protected. This can cause personal injury and/or damage to the equipment.

Warning!

Do not expose batteries (battery pack and batteries installed) to excessive heat such as sunshine, fire or similar. If exposed, the batteries can catch fire. This can cause personal injury, damage to the equipment and the surrounding environment.

Warning!

Be careful when working with strobe and flash units. This will prevent personal injury and/or damage to the equipment.

Warning!

Operation of this equipment in a residential area could cause radio interference.

4.2 CAUTIONS

Caution!

Be careful when you use the camera. The camera is a precision instrument. This will help prevent damage to the camera.

Caution!

Danger of explosion if battery is incorrectly replaced. Replace only with the same or equivalent type.

Caution!

Do not use batteries other than specified. This can cause damage to the batteries.

Caution!

Use protective covers as much as possible. The protective covers will help prevent damage to the equipment.

Caution!

Use a protective case or camera bag when you transport the equipment. This will help prevent damage to the equipment.

Caution!

Protect the equipment from oil fumes, steam, humid conditions and dust. This will help prevent damage to the equipment.

Caution!

Seal all equipment in a plastic bag or similar if you enter damp and humid condition from dry and cold condition. Wait until the equipment has acclimatized to the new temperature before you remove the equipment from bag. This will help prevent damage to the equipment.

Caution!

Avoid frequent and high temperature changes. This can cause damage to the equipment.

Caution!

Keep camera and equipment away from moisture. If your camera becomes wet, disconnect from electric power and let camera dry before further use. This will help prevent damage to the equipment.

Caution!

Store the equipment in a dry environment. This will help prevent damage to the equipment.

Caution!

Be careful when you attach/detach the components to/from the camera. This will help prevent damage to the data bus connections.

Caution!

Use the grip or strap when you lift and handle to camera. This will help prevent damage to the camera.

Caution!

Do not insert fingers into the camera body. This can cause damage to the equipment.

Caution!

Do not touch the lens glass surfaces with your fingers. This can cause damage to the equipment.

Caution!

Do not touch the CMOS Sensor with your fingers. This can cause damage to the equipment.

Caution!

Keep all equipment out of reach of small children. This will prevent damage to the equipment.

Caution!

When cleaning the camera, remove the batteries. This will prevent damage to the camera.

Caution!

If you leave the camera unused for a long period, remove the batteries. This will prevent damage to the equipment.

Caution!

Do not try to remove the glass IR filter from the front of the CMOS (due to dust or similar). This can cause damage to the equipment. Always contact your local Hasselblad Authorized Service Centre.

Caution!

If you use canned compressed air to clean the glass of the IR filter, read the instructions very carefully before use. This will help prevent damage to the filter.

4.3 DISPOSAL



This product must be put in municipal waste.
Check local regulations for disposal.

4.4 FCC

Federal Communication Commission Interference Statement:

This equipment has been tested and found to comply with the limits for a Class B digital device, pursuant to Part 15 of the FCC Rules. These limits are designed to provide reasonable protection against harmful interference in a residential installation.

This equipment generates, uses and can radiate radio frequency energy and, if not installed and used in accordance with the instructions, may cause harmful interference to radio communications. However, there is no guarantee that interference will not occur in a particular installation. If this equipment does cause harmful interference to radio or television reception, which can be determined by turning the equipment off and on, the user is encouraged to try to correct the interference by one of the following measures:

- Reorient or relocate the receiving antenna.
- Increase the separation between the equipment and receiver.
- Connect the equipment into an outlet on a circuit different from that to which the receiver is connected.
- Consult the dealer or an experienced radio/TV technician for help.

FCC Caution

Any changes or modifications not expressly approved by the party responsible for compliance could void the user's authority to operate this equipment.

This device complies with Part 15 of the FCC Rules. Operation is subject to the following two conditions:

- 1 This device may not cause harmful interference, and
- 2 This device must accept any interference received, including interference that may cause undesired operation.

FCC Radiation Exposure Statement:

This equipment complies with FCC radiation exposure limits set forth for an uncontrolled environment. The highest SAR value as reported to the authorities for the CFVII 50C SE 50YOM when tested for use by the Body is 0.27 W/kg and Extremity is 0.301W/kg against a limit of 1.6W/kg.

4.5 ISED

RSS-Gen Information for the Certification of Radio Apparatus
This device complies with ISED licence-exempt RSS standard(s). Operation is subject to the following two conditions:

- 1 This device may not cause interference, and
- 2 This device must accept any interference, including interference that may cause undesired operation of the device.

Cet appareil est conforme au(x) standard(s) RSS exempt(s) de licence de ISED. Son fonctionnement est sujet aux deux conditions suivantes:

- 1 cet appareil ne doit pas occasionner d'interférence
- 2 cet appareil doit supporter toutes les interférences, y compris celles qui pourraient provoquer un mauvais fonctionnement de cet appareil.

RSS-102 RF Exposure Compliance of Radiocommunication

Apparatus

The CFVII 50C SE 50YOM has been designed to comply with safety requirements for exposure to radio waves. SAR testing has been performed in accordance with RSS-102, with the CFVII 50C SE 50YOM transmitting at its highest certified power level in all used frequency bands. The highest Body SAR value for the CFVII 50C SE 50YOM when tested was 0.27 W/kg against a limit of 1.6 W/kg. Extremity SAR was measured to 0.301 W/kg.

Please follow the instructions included in the user guide for product installation and use.

Le X1D-50c a été conçu pour se conformer aux exigences de sécurité en matière d'exposition aux ondes radio.

Des tests SAR ont été effectués conformément à la RSS-102 avec le CFVII 50C SE 50YOM transmettant à son plus haut niveau de puissance certifié dans toutes les bandes de fréquences utilisées.

La valeur SAR la plus élevée pour la CFVII 50C SE 50YOM lors des tests était de 0,27 W/Kg contre une limite de 1.6 W/kg. On a mesuré l'extrémité SAR à 0,301 W/kg.

Merci de suivre les instructions fournies dans le mode d'emploi pour l'installation et l'utilisation du produit.

5.1 PARTS, COMPONENTS, BUTTONS AND CONTROLS



1 **Menu Button**

This button opens the main menu. If the main menu is already active, the control screen is shown.

2 **Cross Button**

Function depends on screen information. The button acts as delete image button in browse mode. The button moves the selector up in menus. In control screen it used for parameter selection.

3 **Star Button**

In browse mode this button is used to rate images. See page 90. If image rating is turned off in the settings (page 125), the star button will zoom out to 9-view. In live view the star button will zoom in to for precise focusing. It is also used as a select button when controlling camera settings using buttons.

4 **Display button**

Function depends on screen information. The button changes the overlay in live view mode. In menus, it moves the selector down. When the control screen is active, it is used for parameter selection.

5 **On/Off and browse button**

A long-press (press and hold for one second) will turn On or Off the camera depending on the previous state. A short-press activates the display and shows the last captured image.

6 **Status LED**

Green color: indicates that the camera is ready to make a capture.

Yellow colour: The camera is busy and not ready to make a capture.

Red color: Error state

Blinking: The image is written to the card or host computer.

7 **Touch display**

Multi-touch display with full touch support to control all settings of the camera as well as panning, pinch and spread zoom for image review. The display can be tilted up to 90 degrees upwards.

Note!

You can force the camera into standby mode to save power by pressing and holding the Menu button and making a short-press on the On/Off button.



1 Control wheel

Control wheel used for aperture and shutter speed setting. In browse mode it will change image.

2 Shutter Release Button

A two-position shutter release button. First position will activate Live View or start AF. Second position will capture the image

3 Lens Mount Index

Index for lens mount alignment.

4 Lens Locking pin

Locks the lens onto the camera. Controlled by the Lens Release Button **(6)**.

5 Lens Contact

Contacts for lens communication.

6 Lens Release Button

Button to release the lens or front protective cover.



1 Contacts

Contacts used for lens and camera control.

3 CFV lock pins

Secures a stable and precise mount for the CFV II back.

2 CFV Hooks

Hooks that hold the CFV II in locked position.

4 CFV Support

Lower support for the CFV II.

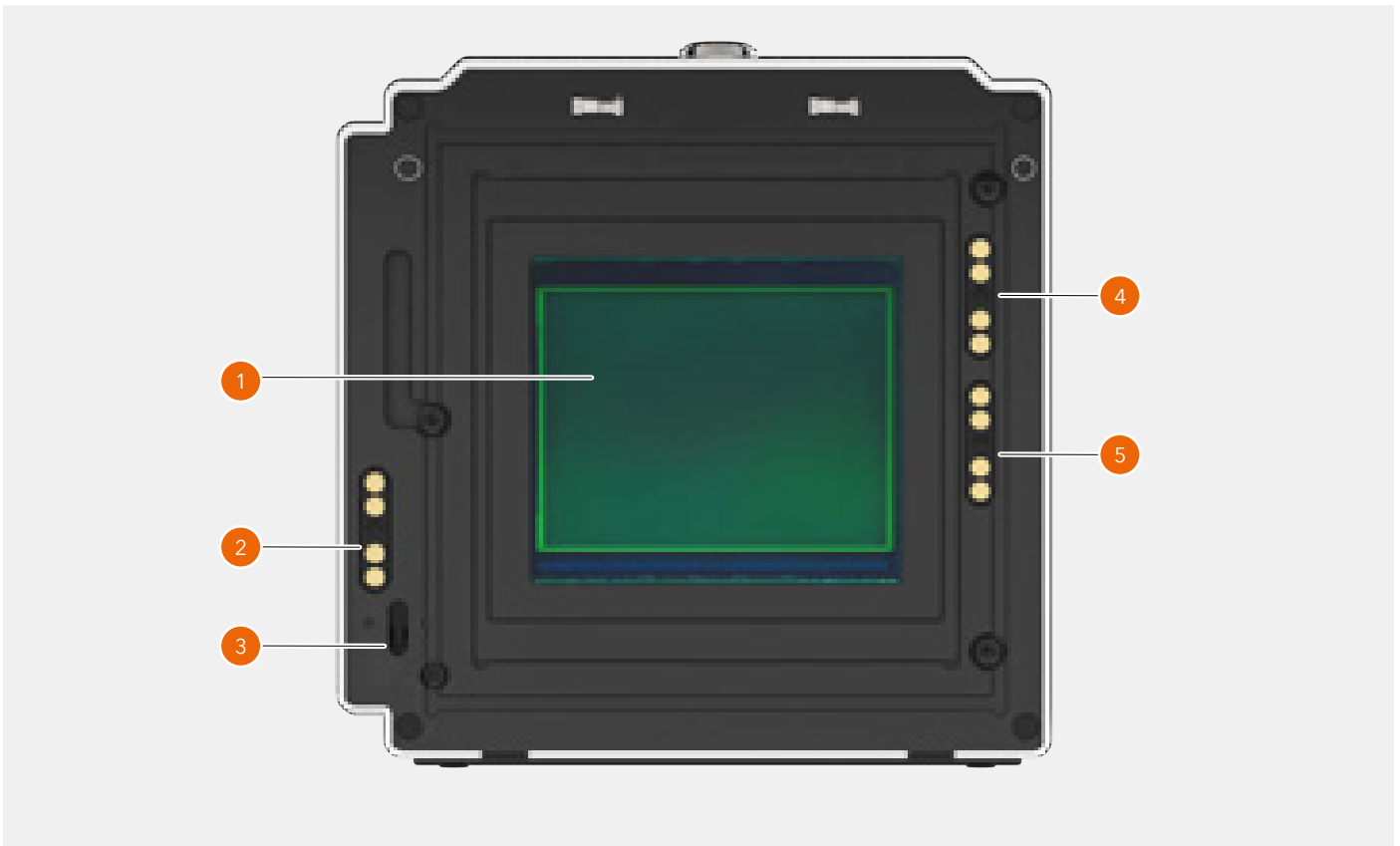

- 1 **Sensor**
Please make sure to read the cleaning instructions in the Appendix on page 155.
- 2 **Contact for 200 Series cameras**
Electrical contact used with modified 200 Series cameras.
- 3 **Release Bar sensor**
Used to synchronize exposure with the 500, EL, SWC, unmodified 200 and 2000 type cameras.
- 4 **907X Contact**
Contact used with the 907X camera body.
- 5 **555 ELD Contact**
Contact used with the 555 ELD camera.

Note!

When the CFV II is used on the 907X body, all contacts are used for body and lens communication.



1 Locking button

Make sure that you hold the back and camera securely. Then slide the locking button to the right to release the CFV II from the camera.

2 Speaker

Openings for audio signals.



3 Lid for Connector Ports

Protective rubber lid for connector ports for audio and sync cables.

4 Control grip lock

Locking hole for the control grip.

5 Control grip connectors

Electrical connectors for the control grip.

6 Tripod thread

1/4 inch tripod thread

7 DC power input

Plug for external DC power input.

Spec: 12-24 VDC/35W.

Plug: 3.7/1.3 mm. Positive voltage on center pin. Make sure polarity is correct not to damage the camera.



1 Lid
Lid for battery and SD cards

2 Battery
Rechargeable battery.

3 Battery Release
Slide the release down to remove the battery.

4 SD Card 1
Slot for SD card number 1.

5 SD Card 2
Slot for SD card number 2.

6 Image plane Index
Indicates the exact location of the image plane. Located behind the right strap lug and behind the battery and SD card lid. See below.

7 Right Strap Lug
Right strap lug for shoulder straps.

8 Shift Button
This button is used to select which of aperture and shutter speed that is controlled by the control wheel.

Image plane index

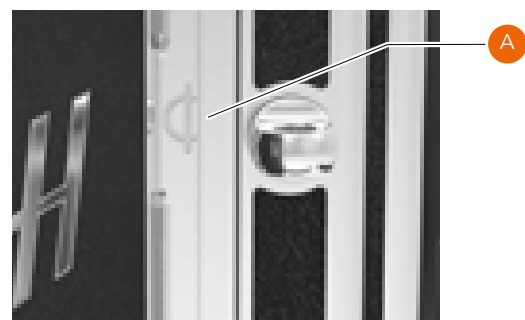

5.2 PORTS AND CONNECTIONS



1 Left strap lug

Left strap lug for shoulder straps.

2 USB Port

USB-3 type C for connection to a host computer or iPad Pro.

3 Microphone

3.5mm stereo input for an external microphone. This port is also used to connect the Release Cord X for vibration free remote release of the camera. See page 152.

4 Headphone

3.5mm stereo output for connection of headphones.

5 Flash sync input

For synchronization with mechanical shutters. Use dedicated flash sync input cable. This input is not used with the 907X.

6 Flash sync output

For connection of external flashes. Use dedicated flash sync output cable.

7 ELX output

Connection to an EL-type camera or the Winder CW. Enables exposure remote control from Phocus. This output is not used with the 907X.

5.3 DISPLAY AND SCREENS

TILT DISPLAY

The display can be tilted 90 degrees up for convenient operation in many situations. E.g. when shooting from a low camera angle. To tilt the display, insert a finger in the groove at the bottom of the display and tilt the display upwards. There are click-stops for 45 and 90 degrees, but any angle in between can be used.

Note!

Always remember to fold the screen to normal position before transporting the camera.



6.1 TOUCH DISPLAY

The rear display is touch sensitive and you can use it in the same way that you navigate on a smartphone. You can also navigate by using the 5 buttons below the Touch Display and Scroll Wheel on the Camera.

The display can show a number of different screens, as shown on the next page, including:

- Live view - Live update with high frame rate
- Browse screen
- Menu screens - Detailed camera settings
- Control Screen - Quick overview and access to most camera settings

TOUCH DISPLAY NAVIGATION

The following gestures can be used to navigate and control the camera:

- **Swipe left**
Place the finger on the right side of the screen and move to the left **(A)**.
- **Swipe Right**
Place the finger on the left side of the screen and move to the right **(B)**.
- **Swipe down**
Place the finger at the top of the screen and move down **(C)**.
- **Swipe up**
Place the finger at the bottom of the screen and move up **(D)**.
- **Tap**
Touch an icon and then lift the finger again.
- **Double Tap**
Quickly tap the display two times (within 1 second).
- **Press**
Place the finger on an icon and then hold for one second.
- **Spread**
Place two fingers on the display close together and move them apart without lifting them from the surface to zoom in **(E)**.
- **Pinch**
Place two fingers on the display apart and move them together without lifting them from the surface to zoom out **(F)**.

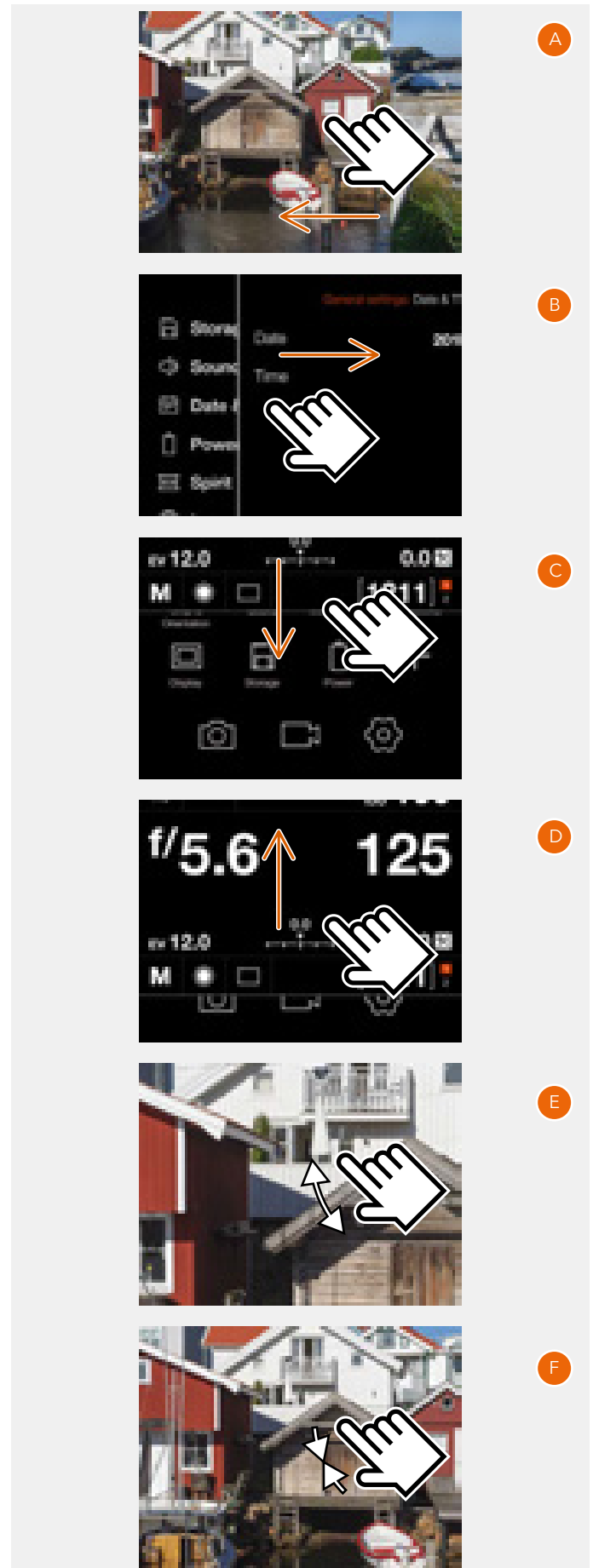

AVAILABLE SCREENS

The rear display can show the following type of screens:



- **Main menu (A)**
Menu- and Short-cut icons.
- **Control screen (B)**
Status Screen.
- **Menu (C)**
Sample menu screen
- **Setting (D)**
Sample setting screen.
- **Browse image (1-view) (E)**
Preview screen, one image.
- **Browse images (9-view) (F)**
Preview screen, 9 images.
- **Live view (G)**
Continuously updated live view.



6.2 TOUCH DISPLAY MAIN MENU

MAIN MENU

In the main menu **(A)** there are 3 different main Settings **(4)**:

- Camera settings **(1)** 
- Video settings **(2)** 
- General settings **(3)** 

The placement of these 3 setting icons are fixed and cannot be changed.

The icons on the left part of the main menu **(5)** are favourite shortcuts to functions. They can be replaced and rearranged. See page 48. Shortcuts in this example:

- Exposure
- Connectivity
- Display
- Power
- Quality
- Focus
- Storage

The plus sign **(6)** is used to add a new shortcut.

ADD SHORTCUTS TO MAIN MENU FAVOURITES

To speed up your own workflow you can add in the settings you use more frequently in the Favourite settings. These functions will then be displayed on the main menu until you remove them and replace them with other Favourite settings. To add, remove or move a shortcut, see the instructions on the following page

The available shortcuts to add are:

- | | |
|--------------------|--------------|
| Exposure | Preview |
| Crop & Orientation | Touch |
| Quality | Storage |
| Focus | Sound |
| Flash | Date & Time |
| Configuration | Power |
| Quality (video) | Spirit Level |
| Live View (video) | Language |
| Connectivity | Service |
| Display | About |
| Live View | |

See detailed description on how to add and remove shortcuts to your favourite list on the following page.



HOW TO ADD SHORTCUTS TO MAIN MENU

- 1 Select the **+** icon **(A)** on the main menu.
- 2 The add favourite pop up screen displays the available options to add in a scroll list.
- 3 Select for example Spirit Level **(B)**.
- 4 The spirit level icon is now displayed on the main menu and the action is saved in the camera memory. The spirit level function can be quickly accessed by tapping the icon.

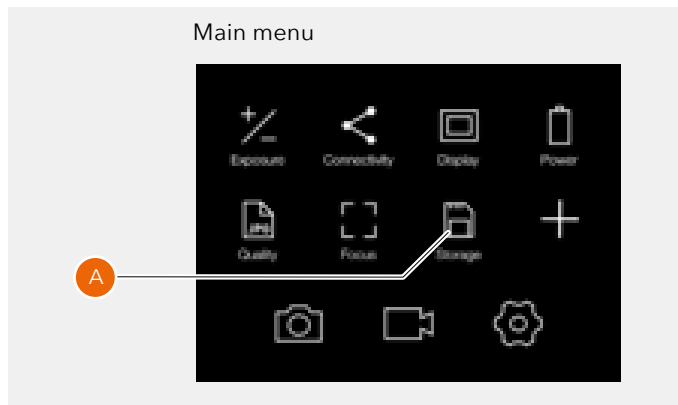

HOW TO REMOVE SHORTCUTS ON THE MAIN MENU

- 1 Press and Hold on the icon you would like to remove from the main menu Favourites. Spirit Level **(C)** in this example.
- 2 The delete symbol **⊗** is displayed on the upper right corner of the selected shortcut **(D)**.
- 3 Tap the delete symbol **⊗** to delete the icon and remove the function from the main menu favourites.
- 4 The spirit level icon is no longer displayed in the main menu favourites list. You can add the same function later at any time.
- 5 To return to standard main menu without deleting the shortcut, tap the lower right **(F)** or left corner **(E)** of the display.

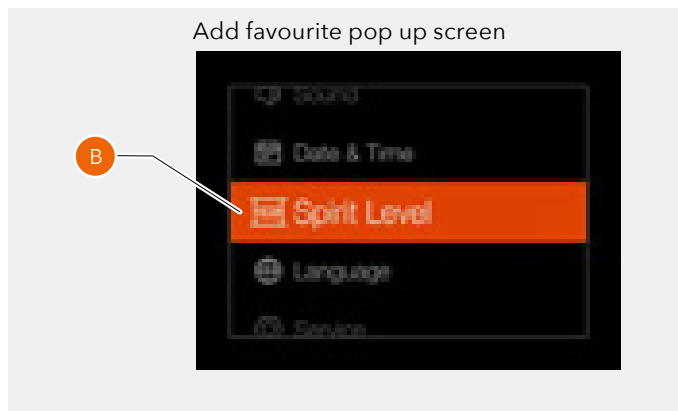

HOW TO MOVE SHORTCUTS ON THE MAIN MENU

- 1 Press and Hold on the icon you want to move until the close symbol **⊗** appears **(D)**.
- 2 Press and hold the icon and drag it to a new location. Icons will automatically rearrange.

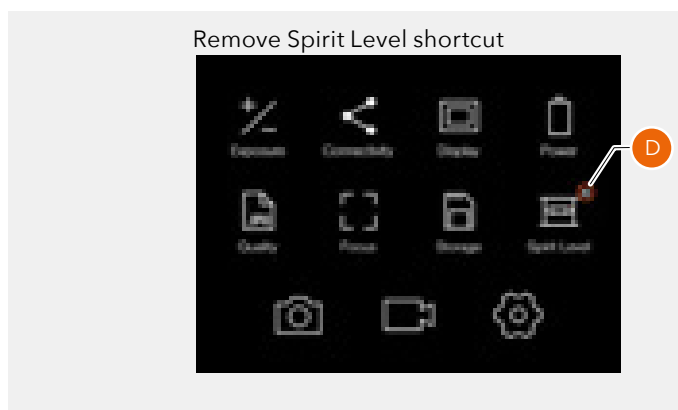
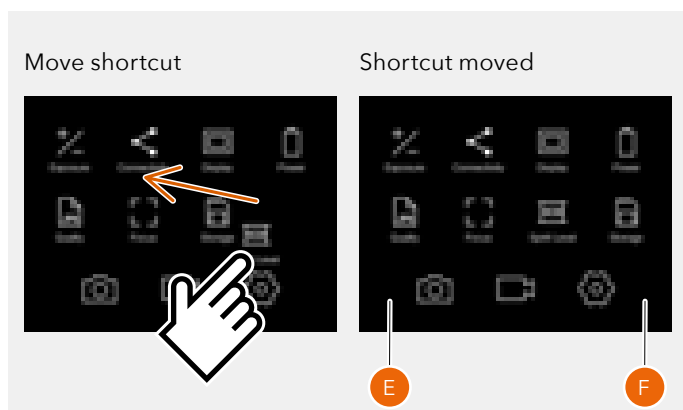
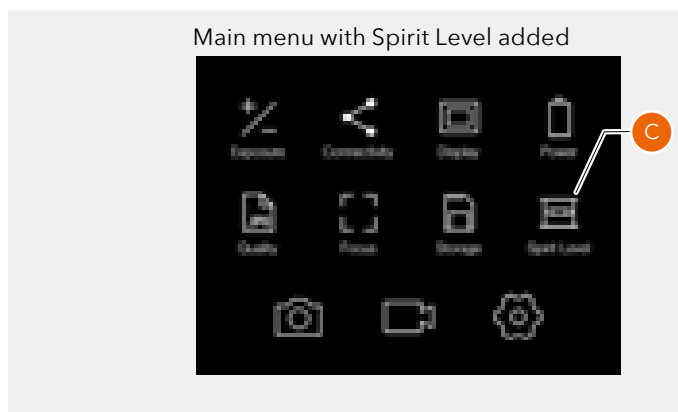

CONTROL SCREEN

This is a status screen showing the actual settings of the camera. From this screen, you can also change settings directly.

The control screen can be activated in two ways:

- Form any screen, you can slide in the control screen by swiping the display from the top.
- Press the menu button until the control screen is shown (requires 1 or 2 clicks).



From the Control Screen you can directly change the following settings:

- White balance **(1)**
- Autofocus mode **(2)**
- ISO **(3)**
- Aperture **(5)**
- Shutter speed **(14)**
- Exposure mode **(7)**
- Light metering mode **(8)**
- Drive mode **(9)**
- Fixed exposure adjustment **(13)**

Change settings using touch

Tap the value to bring up a setting dialogue. See page 51.

Change settings using buttons

Press the rectangle button  or the cross button  to highlight the setting you want to change. Press the Star Button  to bring up the setting dialogue.

Use the Rectangle button or the cross button to select new value. Accept with the Star Button.

The control screen also shows the following status indications:

- Battery status with optional percent value **(4)**.
- Remaining captures on card (free space) **(11)**
- Card status **(12)**. See more on page 70.

Depending on camera mode and setting, the control screen can show additional information. This will be explained in detail later in this user guide.

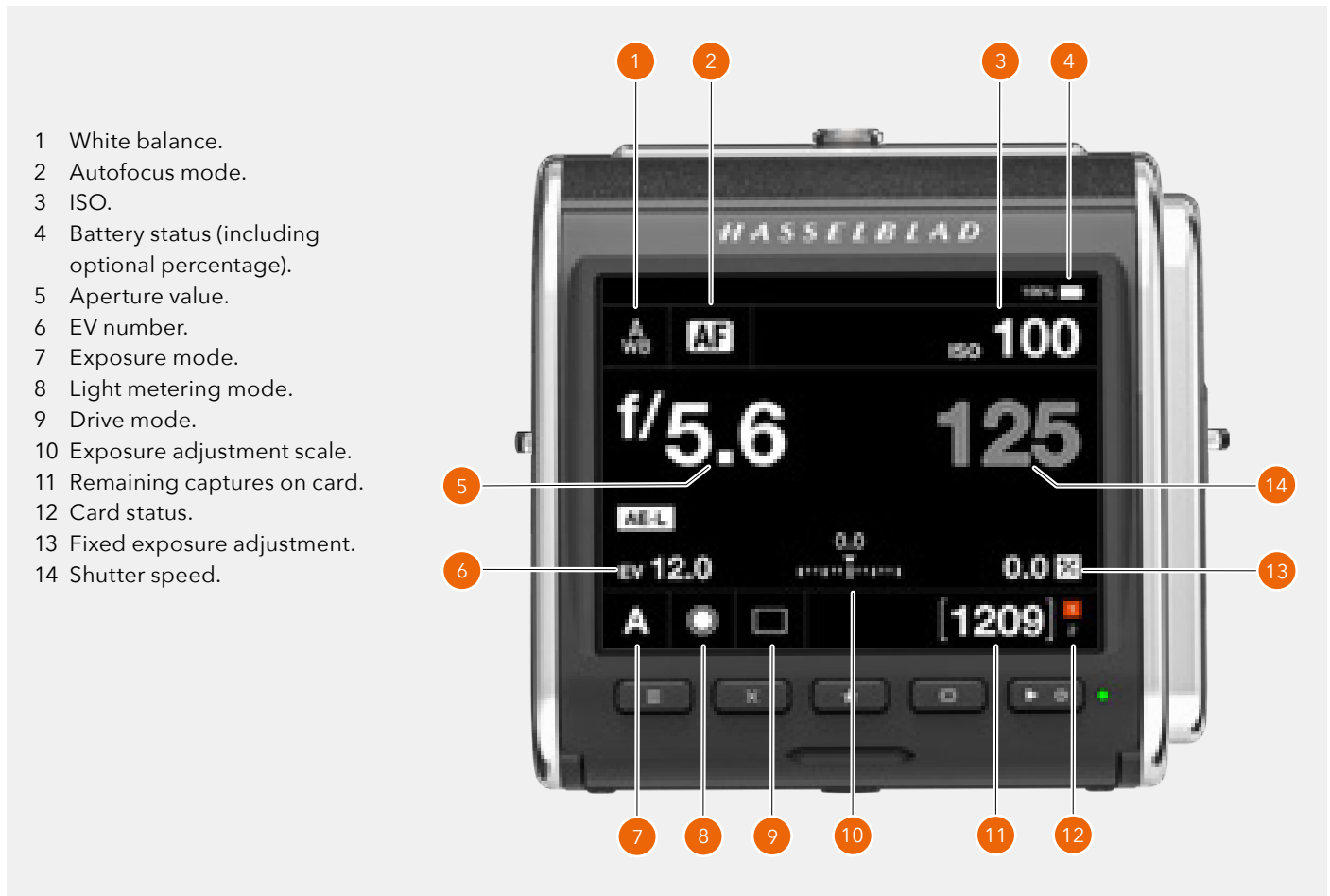

- 1 White balance.
- 2 Autofocus mode.
- 3 ISO.
- 4 Battery status (including optional percentage).
- 5 Aperture value.
- 6 EV number.
- 7 Exposure mode.
- 8 Light metering mode.
- 9 Drive mode.
- 10 Exposure adjustment scale.
- 11 Remaining captures on card.
- 12 Card status.
- 13 Fixed exposure adjustment.
- 14 Shutter speed.

LOCKED EXPOSURE PARAMETERS ON THE CONTROL SCREEN

When an automatic exposure mode is selected, either aperture, shutter speed or both are set automatically by the camera. In this case that value cannot be changed from the control screen. This is indicated by showing the locked value in grey color.

Control Screen



A Mode

For Aperture priority (**A**) you can change the Aperture value but the Shutter value will be automatically set and is therefore displayed in grey.

Control Screen

A Mode

Shutter Speed is set automatically.

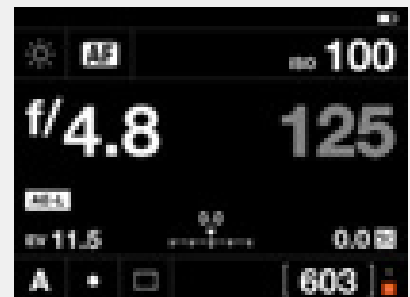

S Mode

In Shutter priority (**S**) you can change the Shutter speed value but the Aperture value will be automatically set and is displayed in grey.

Control Screen

S Mode

Aperture is set automatically.



P Mode

When you select Program Mode (**P**) both Aperture (5) and Shutter speed (100) are automatically set and displayed in grey colour indicating that you cannot change them by touch. Note that you can use the front control wheel to shift aperture and shutter speed combination.

Control Screen

P Mode

Aperture and Shutter Speed are set automatically.

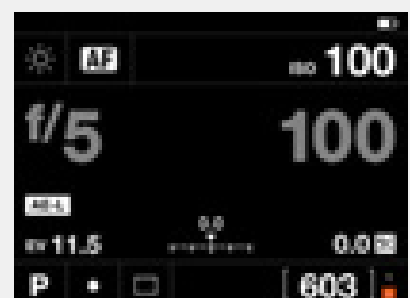

SETTINGS ON THE CONTROL SCREEN

Aperture

- Select Aperture value.

Swipe the list and tap the desired value to select.

Shutter Speed

- Select Shutter speed value.

ISO

- Select ISO value.

Note!

ISO can also be set by touch from the Live View screen. See page 75.

Focusing

- AF Autofocus.
- MF Manual focus.

Tap the new value to select.

Aperture



Shutter

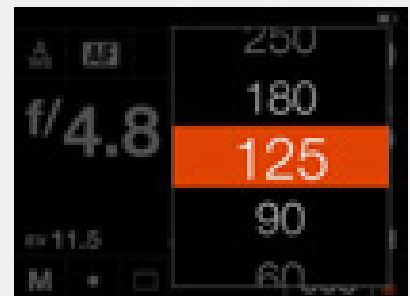

ISO

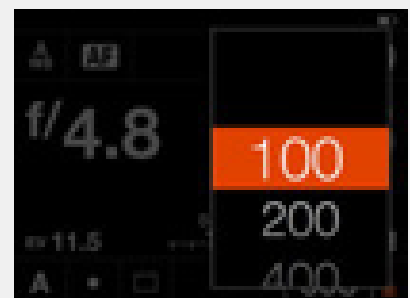

Focusing



This chapter continues on the next page.

Settings on the Control Screen

White balance

- Auto white balance AWB.
- Cloudy.
- Shade.
- Daylight.
- Tungsten.
- Fluorescent.
- Flash.
- Manual white balance MWB
- Picker (select white balance from image).

Change white balance preset

On the control screen, tap the white balance icon in the top left corner. This brings up the white balance setting screen (1). Tap on one of the white balance icons to select it (A). The right frame of the screen (B) will show the values for Temperature and Tint associated with the selected white balance. Tap the white balance icon again to select it and return to the control screen.

Setting manual white balance values

From white balance setting screen (1), change value for Temperature or Tint by tapping in the right frame (B).

Tap the value (C) to change and select a new value from the list (D).

Tap the left arrow (E) to return to the white balance setting screen (1). Finally, tap the manual white balance icon again to select it and return to the control screen (2). White balance has now been set to Manual mode.

Note!

ISO can also be set by touch from the Live View screen. See page 75.

Continued on the next page.

| | Temp [°K] | Tint |
|--------------------|---------------------------|-------------------------|
| Cloudy | 6500 | 10 |
| Shade | 7500 | 10 |
| Daylight | 5500 | 10 |
| Tungsten | 2850 | 0 |
| Fluorescent | 3800 | 21 |
| Flash | 5500 | 0 |
| Manual | Variable 2000 to 10000 | Variable -100 to 100 |

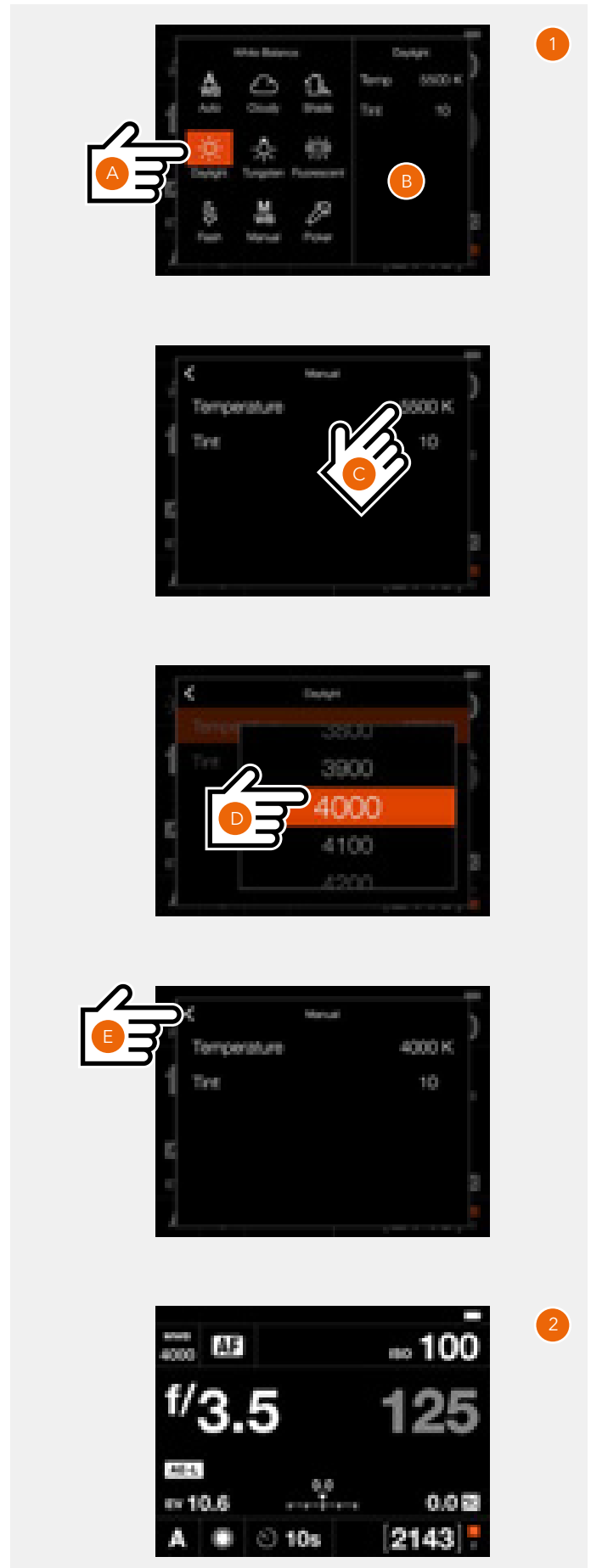

Settings on the Control Screen

Set White balance from image (Picker)

Tap the white balance icon on the control screen to bring up the settings screen. Tap the Picker icon (A).

The screen will show the last captured image with a white balance picker tool (B).

If the center of the image is not neutral, move the picker tool by touching anywhere inside the circle (1) and sliding so that the measuring area (2) falls over a neutral area (C). The status bar will show the actual values for Temp and Tint. To accept these values, press the rectangle button (5). To exit without saving the values, press the cross button (4).

The control screen will now show the new value for Temp (D) and it will be used together with Tint for following images.

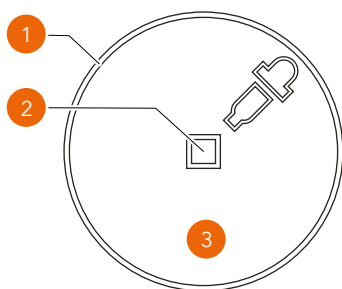

- 1 Active area for moving the tool by touch.
- 2 Active area for calculating Temperature and Tint.
- 3 Active area for fine-tuning the position.

Note!

You can change to another image by turning the front scroll wheel or by swiping the image outside of the picker tool area.

Note!

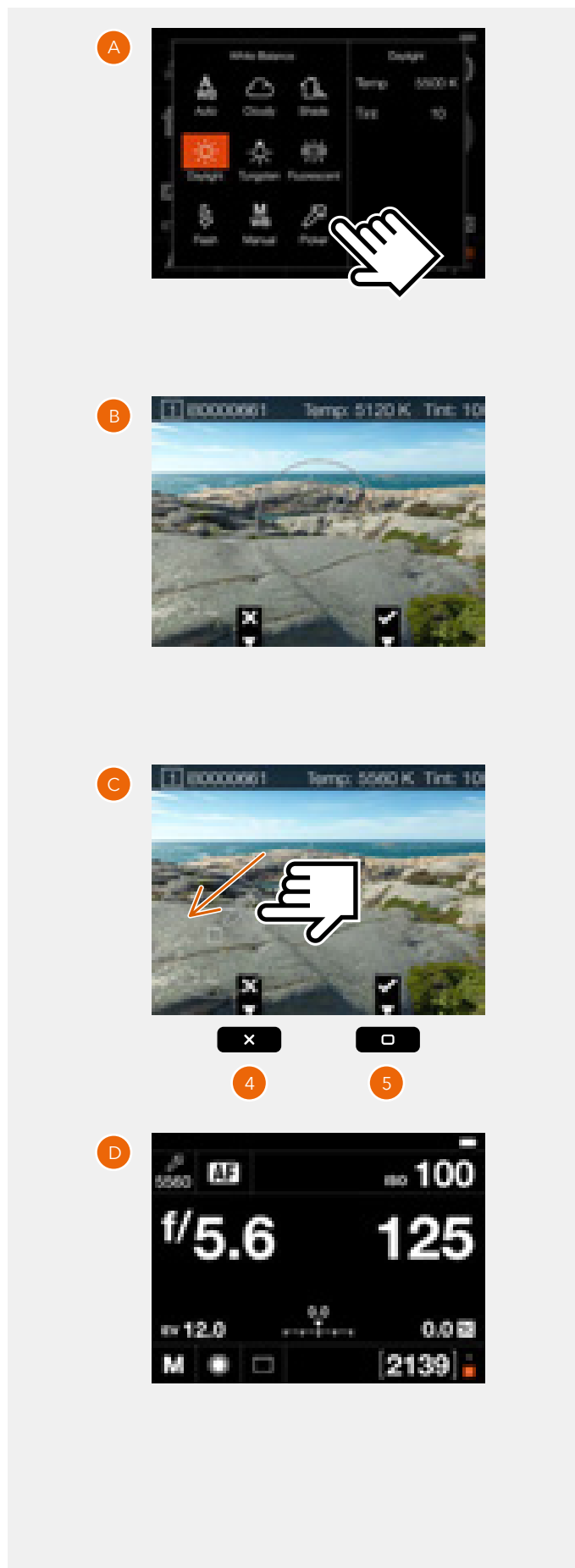

You can fine-tune the position by tapping inside the circle. E.g., if you tap at point (3), the picker will move a small increment down.

This chapter continues on the next page.



Settings on the Control screen

Exposure Mode

- M Manual mode.
- A Aperture priority mode.
- S Shutter priority mode.
- P Program mode.
-  Full auto
-  Video

Metering Mode

- Centre weighted.
- Spot.
- Centre spot.

Exposure adjust

- Adjust exposure by sliding right or left.

Tapping the line to the left or right of the dot, will increase or decrease the value with the value set in **Main Menu > Camera Settings > Exposure > Increment Step Size > exposure Adjust**.

Reset the value to zero by double-tapping the  icon to the left of the line.

See also page 68.

Exposure Mode



Metering Mode

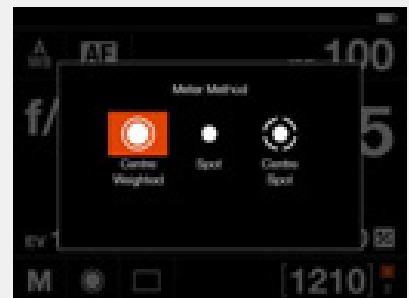

Exposure Adjust



Settings on the Control screen

Drive mode

By tapping the drive mode icon **(A)** on the control screen, you can select the following drive modes:

- Single**
 The camera will only make one exposure regardless how long the Shutter release button is pressed.
 Tap the Single icon again **(B)** to close the dialogue make it active.
- Continuous**
 The camera will make exposures as long as the Shutter release button is pressed.
 Tap the Continuous icon **(C)** again to close the dialogue make it active.

Continued on the next page.

Control Screen



Single frame Drive mode

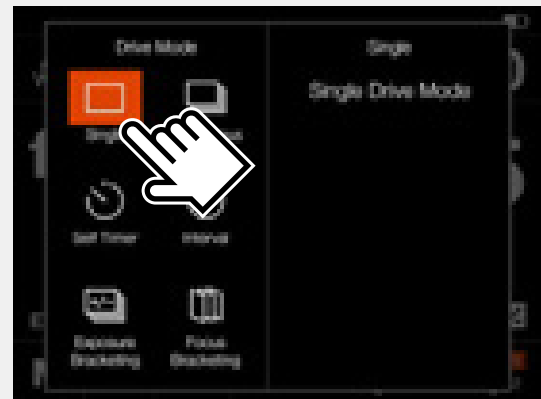

Continuous Drive mode



- **Self Timer (A)**

The camera will wait a pre-set time to make the exposure after the Shutter release button is pressed.

Time: Delay between shutter release and exposure.

When Finished: Determines if the function shall be active after a completed cycle or not. If set to **Exit**, the Self Timer is disabled after the exposure.

- **Interval (B)**

The camera will make a pre-determined number of exposures with a pre-set interval time.

Time: The time between exposures.

Frames: How many exposures will be made.

Initial Delay: Delay between shutter release and first exposure.

When Finished: Determines if the function shall be active after a completed cycle or not.

- **Exposure bracketing (C)**

The camera will automatically make a pre-determined number of exposures with a pre-set exposure adjustment difference between each frame.

Amount: How much exposure difference between each exposure.

Frames: The number of exposures in the sequence.

Initial Delay: A delay between shutter release and the first exposure.

Initial Delay: Delay between shutter release and first exposure.

Param in M: Which of aperture or shutter speed to change if exposure bracketing is used in manual mode.

Sequence: Determines which order exposure adjustment is added.

When Finished: Determines if the function shall be active after a completed cycle or not.

Self Timer



Interval

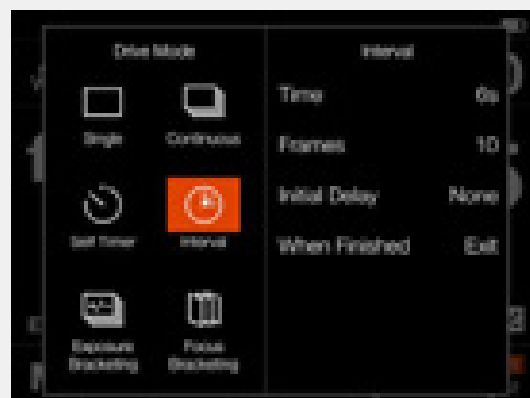

Exposure Bracketing

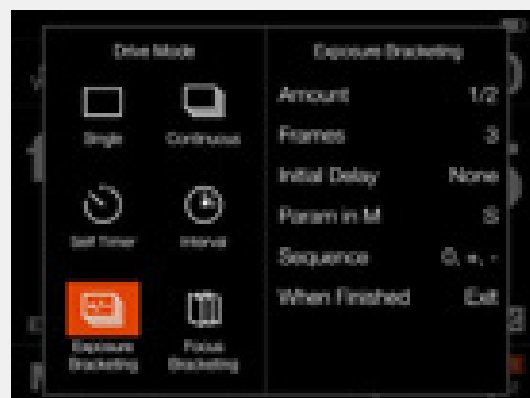

For **Self Timer**, **Interval** and **Exposure bracketing** the left part of the panel displays the current setting. If no changes are required, tap the function icon again to make it active. To change any of the parameters, tap the right part of the screen (D). This will bring up the dedicated settings for the function. See details on the following pages.

SELF TIMER SETTINGS

On the control screen tap the drive mode icon to bring up the settings screen **(A)**.

Tap the Self Timer icon **(1)**. To change settings, tap the right panel **(2)** to show the settings menu **(B)**.

To change any of the settings, tap the value **(3)** to bring up any of the screens **(E)** or **(F)**.

When the settings are made, tap the left arrow **(4)** to return to the drive mode settings screen. Finally, tap the Self Timer icon again to make it active.

When the shutter release is fully pressed, the rear screen will show the count down screen **(E)**. After the pre-set time is elapsed, the exposure will be made.

Select **Exit** by pressing the Cross button **(x)** if you want to cancel the Self Timer.

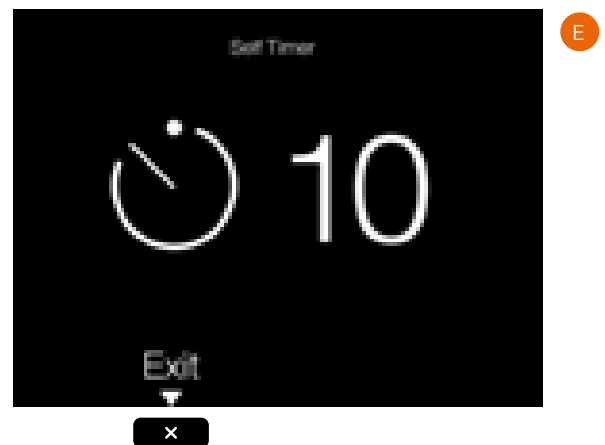
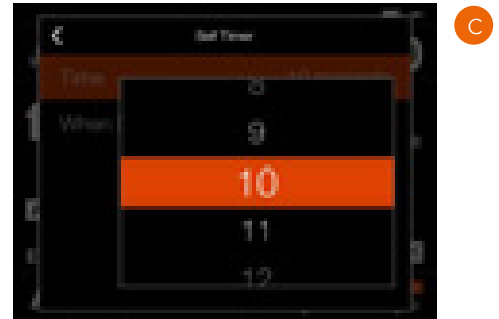

INTERVAL SETTINGS

On the control screen tap the drive mode icon to bring up the settings screen **(A)**.

Tap the Interval icon **(1)**. To change settings, tap the right panel **(2)** to show the settings menu **(B)**.

To change any of the settings, tap the value to bring up any of the screens **(C)** to **(F)**.

When the settings are made, tap the left arrow **(4)** to return to the drive mode settings screen. Finally, tap the Interval icon again to make it active.

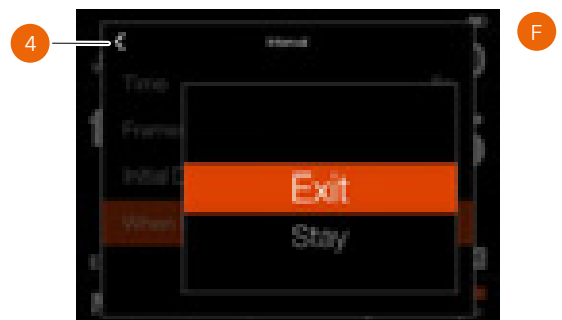
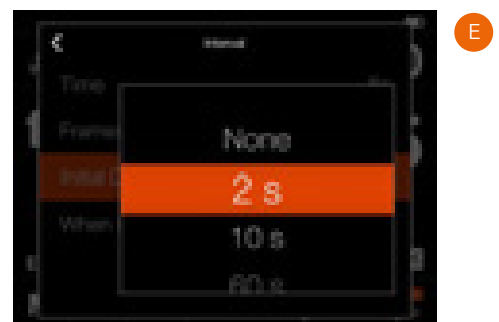
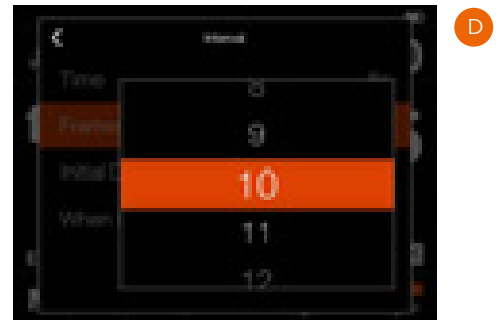
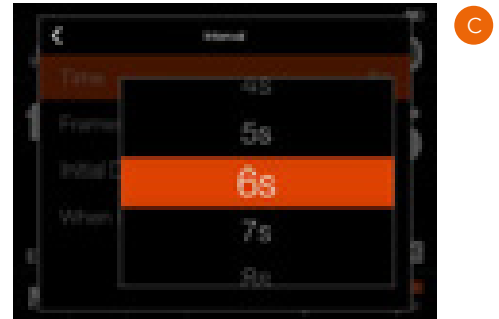

Continued on the next page.

INTERVAL OPERATION

An active and pending Interval Timer, is indicated both on the control screen and in live view.

the control screen shows the interval icon **(A)** and the interval time **(B)**. To see all settings, tap the Interval Icon to show the settings screen as described on the previous page.

Live View and preview screens show the same information with the addition of remaining number of captures **(C)** and **(D)**.

To start the sequence, press the shutter release. If you have set an initial delay to prevent camera shake, the camera will first wait the pre-set number of seconds showing a black screen with a count-down timer, and then start the Interval sequence.

After a capture, the image will show up on the rear screen, together with the Interval information.

To end the sequence before all captures have been made, select **Exit** by pressing the star button .

Note!

Live view is turned off during an interval sequence.

Note!

The preview can be turned off in the **General Settings > Preview > Rear Screen** setting.

Note!

During a running interval sequence, you can press the menu button to activate the control screen to check current status.

Note!

Interval is not supported in Phocus Mobile 2 or when tethered to Phocus. For tethered operation, use the Capture Sequencer function in Phocus.

Control Screen

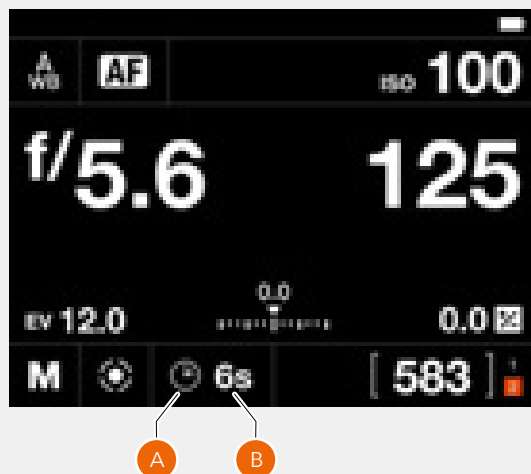

Live View

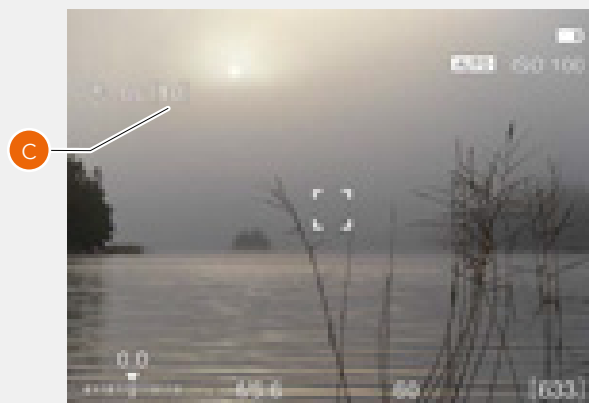

Preview Screen after a capture



EXPOSURE BRACKETING SETTINGS

On the control screen tap the drive mode icon which brings up the settings screen **(A)**. Tap the exposure bracketing icon **(1)**. To change settings, tap the right panel **(2)** to show the settings menu **(B)**. To change any of the settings, tap the value to bring up any of the screens **(C)** to **(H)**.

When the settings are made, tap the left arrow **(4)** to return to the drive mode settings screen. Finally, tap the exposure bracketing icon again to make it active.

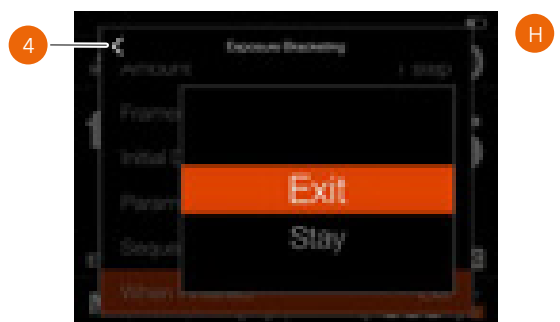
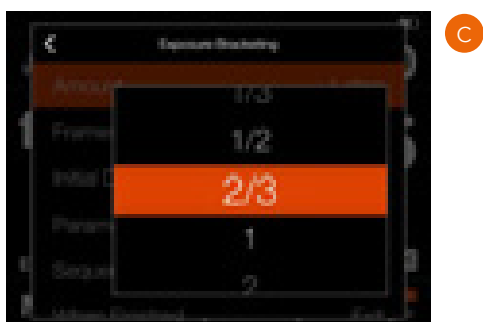
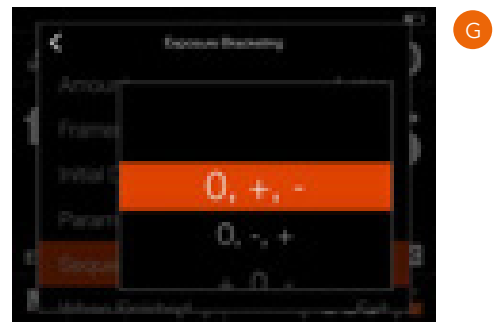
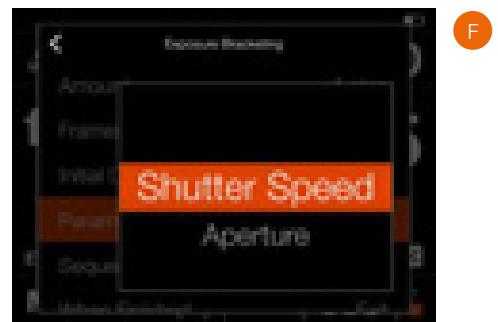
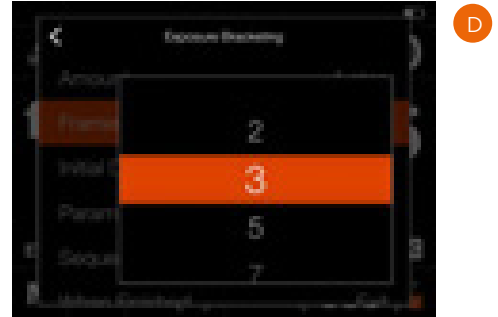
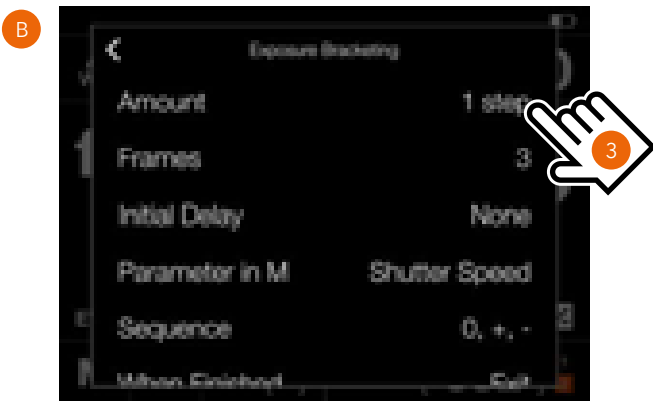
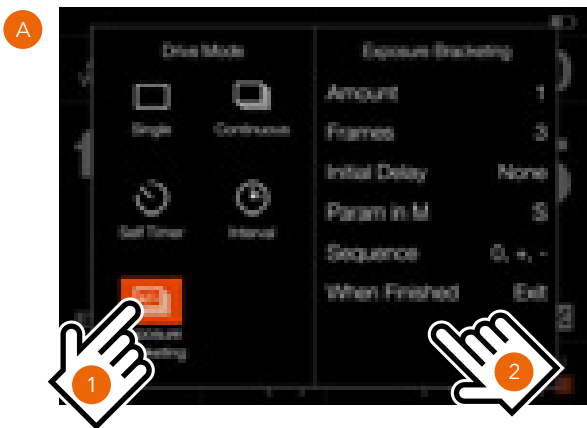

EXPOSURE BRACKETING OPERATION

An active and pending exposure bracketing function, is indicated both on the control screen and in live view.

The control screen and live view will show the bracketing icon and the number of captures in the sequence. To see all settings, tap the interval icon to show the settings screen as described on the previous page.

In the example to the right, the exposure bracketing sequence will use 3 images.

To start the sequence, press the shutter release. If you have set an initial delay to prevent camera shake, the camera will first wait the pre-set number of seconds showing a black screen with a count-down timer, and then start the interval sequence.

During the exposure bracketing sequence, the rear screen will show an information overlay, as shown in **(A)**.

To exit from the sequence before it has been completed, select **Finish Exposure** by pressing the cross button **x**.

After a capture, the last image will show up on the rear screen

LONG EXPOSURE SCREEN

If the shutter speed is 1 second or longer, the long exposure screen **(B)** will be shown during the exposure.

Press the cross button **x** to cancel the current exposure. After about 5 seconds the display will be turned off and the camera will enter a power-save mode.

Note!

Exposure bracketing is not supported in Phocus Mobile 2 or when tethered to Phocus. For tethered operation, use the Capture Sequencer function in Phocus.

Note!

Light measurement, focusing and auto white balance are performed before the first exposure and is applied to all images in the sequence.

Control Screen



Live View



Screen during Bracketing operation

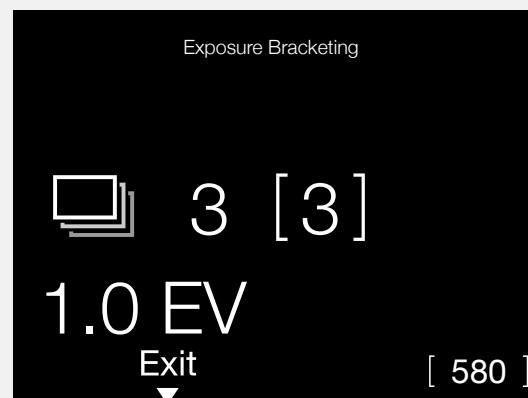

Screen when shutter speed is 1 sec or longer.



FOCUS BRACKETING

Focus Bracketing can be used for different purposes. The most obvious is to achieve a larger depth-of-field by stacking images with different focus positions together in post-production. You can also use it to pick the best image from a batch.

In Focus Bracketing mode, the camera will automatically take a pre-set number of images and calculate focus shift between each capture. The images will be stored on the card as separate files and you can edit them manually or use a 3rd party software (e.g. Helicon Focus™) to merge them together into a final stacked image.

It is difficult to give detailed guidelines on which settings to use, but look at the examples in this section as a starting point for your own experiments.

The camera offers three different modes in which the images will be taken.

1 Towards Infinity

Set focus manually or by using AF. If AF is used, remember to deactivate it before starting the sequence. In this mode, focus should be set on a point **(A)** that is closer to the camera than the main subject. When the sequence is started, focus will be shifted towards infinity until the sequence is finished or the lens reaches infinity position.

2 Symmetric

In this mode, focus should be set on the main subject **(B)**. When the sequence is started, the camera will first take an image and then move to a focus point closer to the near limit and take all the images in the sequence, shifting focus towards infinity. The first image is an extra exposure made to ensure that there is one image of the main subject with perfect focus.

3 Towards Near Limit

Set focus on a point **(C)** behind the main subject. During the sequence, the camera will shift focus closer and closer to the camera. The sequence will stop after the pre-set number of images has been captured or the lens has reached near limit.

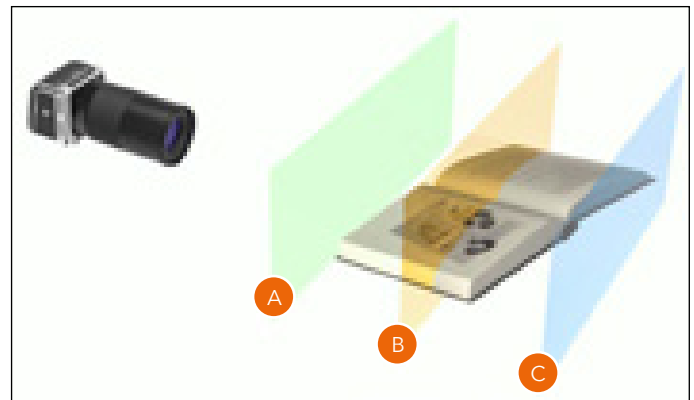

Single image, XCD 120 f/6.8



Stacked from 40 images. XCD 120, f/6.8, Step = Medium



FOCUS BRACKETING SETTINGS

On the Control Screen tap the Drive Mode icon which brings up the settings screen **(A)**. Tap the Focus Bracketing icon. To change settings, tap the right panel **(1)** to show the Settings Menu **(B)**.

To change any of the settings, tap the value **(2)** to bring up any of the screens **(C)** to **(H)**.

When the settings are made, tap the left arrow **(I)** to return to the Drive Mode settings screen.

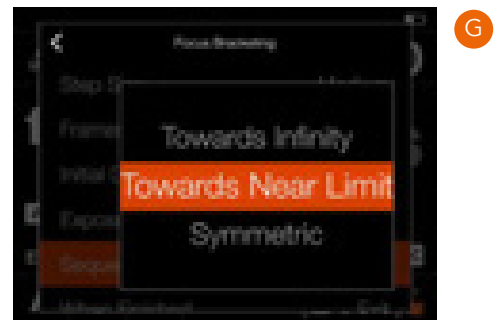
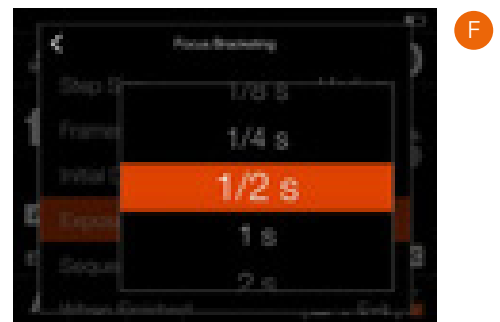
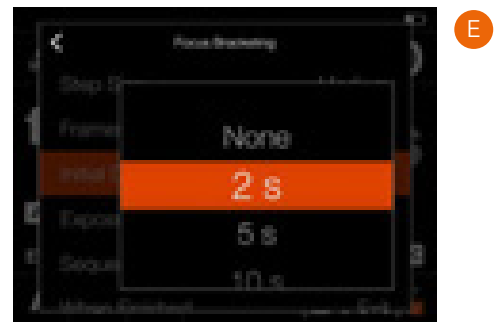
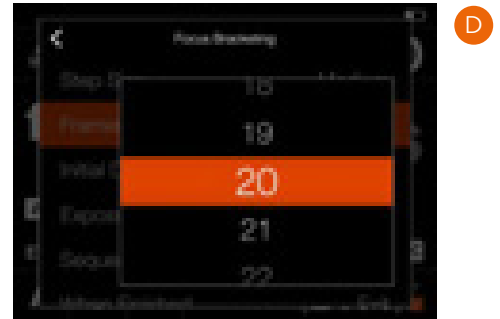
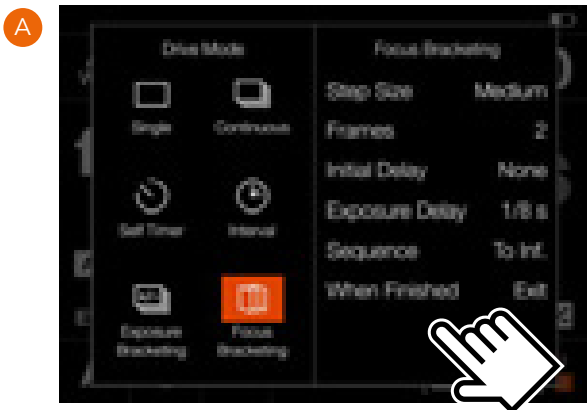

FOCUS BRACKETING OPERATION

An active and pending Focus Bracketing function is indicated both on the Control Screen and in Live View (A).

In the example on the right, the Focus Bracketing sequence will take 40 images.

To start the sequence, simply press the shutter release and all captures will be made automatically. If required, you can set a delay before the first capture. A separate delay can also be set between frames to minimize vibration or to allow a flash to charge.

During the Focus Bracketing sequence, the rear screen and EVF will show the selected Browse Overlay with an extra information overlay, as shown in (B).

- 1 Focus Bracketing Icon
- 2 Remaining captures
- 3 Number of captures in the sequence
- 4 Focus adjustment step between captures.

To exit from the sequence before it has been completed, press the Cross Button (5).

After a completed sequence, the last image will show up on the rear screen.

Note!

The Focus Bracketing function requires a firmware update for the Lens. Use version 0.5.33 or later for XCD lenses. The XCD 45P requires version 0.1.24.

Note!

HC/HCD lenses cannot be used for Focus Bracketing.

Note!

Focus Bracketing is not supported in Phocus Mobile or when tethered to Phocus.

Note!

Light measurement, focusing and Auto White Balance are performed before the first exposure and is applied to all images in the sequence.

Control Screen



Live View

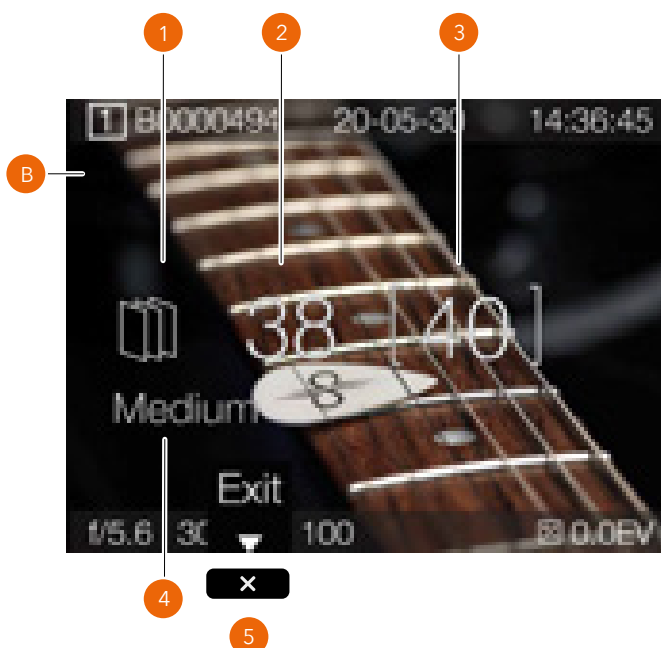
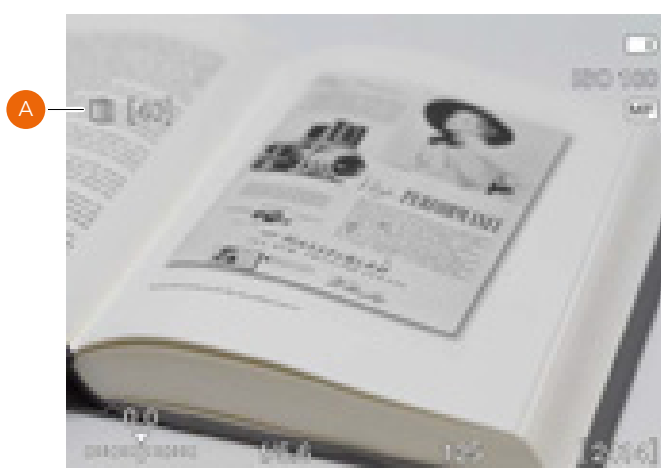

STEP SIZE

For high-quality work you should normally select Small or Medium step size. For less critical work you can also use Large or Extra Large. Large or Extra Large can also be used in certain situations when the type of subject allows. To find what works best for your situation, we encourage you to make experiments.

For this test two different step sizes was used , Small and Extra Large. In the resulting image from the Extra Large setting, there are clearly visible unsharp areas. The image using Small is perfectly sharp in all areas.

Test image. F/5.6. 80 images.



Magnified part from image using Small step size.



Magnified part from image using Extra Large step size.



Continued on the next page.

The step size is related to the depth of field (DoF) produced by the camera at a given aperture. This means that the actual focus shift in the subject will be larger with a higher aperture number. E.g. f/4 will give a smaller step than f/11. However, before each exposure, the camera will automatically calculate the actual step size using the current focus position, focal length of the lens, aperture and pixel dimensions of the sensor.

In the subject, the DoF will grow as the focus point is moved away from the camera. The distribution of the DoF around the focus point will also be more uneven. The DoF on the far side of the focus point will grow more than the DoF in front of the focus point.

As the camera will automatically make all the calculations for you, the only thing that really needs consideration is how many images to make in the sequence. In most cases, it is best to set a number that is too high rather than too low. The camera will automatically stop when the lens cannot be focused further or closer.

DOF AND STEP SIZE VISUALIZED

To the right is a typical subject where Focus Stacking could be used.

With step size set to Medium, there will be no unsharp areas between each image. Please note that DoF is relative and how it is perceived greatly depends on the viewing magnification of the final result. The circle of confusion (CoC) is used to determine the depth of field, see also https://en.wikipedia.org/wiki/Circle_of_confusion.

The bottom image shows how the DoF will change between captures and also how the focus step in the subject will automatically increase as the DoF is increased.

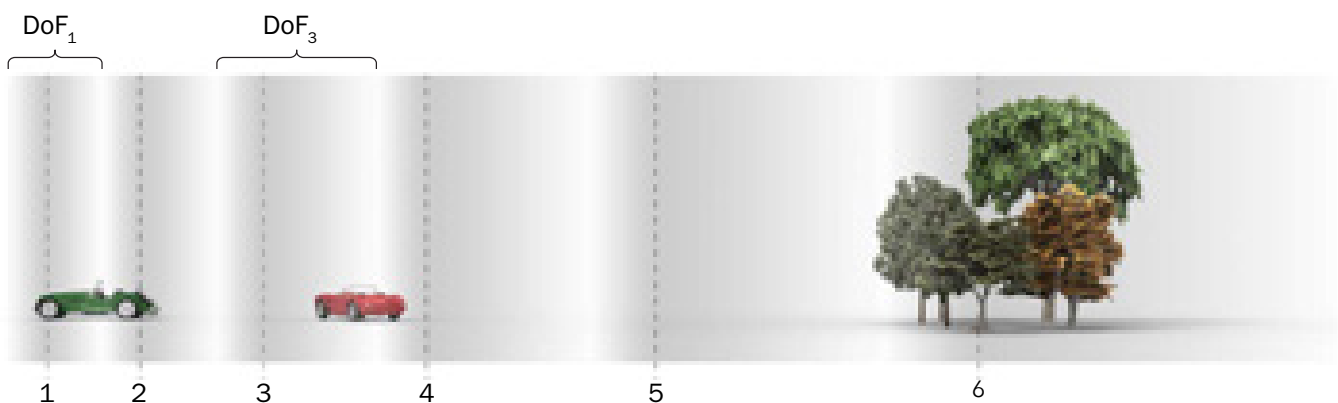

The table to the right shows the actual Circle of Confusion (CoC) used for the different step sizes. PP is the Pixel Pitch of the sensor which is the distance between two adjacent pixels.

| STEP SIZE | CoC |
|-------------|-----------------------------------|
| Extra Small | $1 \times PP = 5,3 \mu\text{m}$ |
| Small | $4/3 \times PP = 7,1 \mu\text{m}$ |
| Medium | $2 \times PP = 10,6 \mu\text{m}$ |
| Large | $4 \times PP = 21,2 \mu\text{m}$ |
| Extra Large | $6 \times PP = 31,8 \mu\text{m}$ |

EXAMPLES

This page shows a few examples to give you a starting point for which settings to use. Best results will always be achieved from your own experiments. Use the zoom feature of the PDF reader to study the images closer.

EXAMPLE 1 – KNIFE

XCD 120 Macro lens.
 Subject distance: 80 cm
 Aperture: f/8
 Number of images: 50
 Step Size: Medium



EXAMPLE 2 – SPIRAL STAIRCASE

XCD 35-75 lens @35mm.
 Subject distance: 75 cm
 Aperture: f/8
 Number of images: 15
 Step Size: Medium

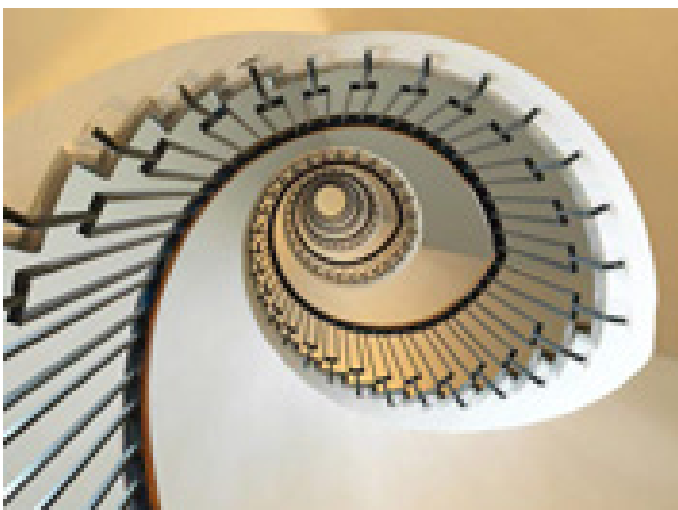

EXAMPLE 3 – V CAMERA SHELLS

XCD 65 lens.
 Subject distance: 120 cm
 Aperture: f/8
 Number of images: 35
 Step Size: Small

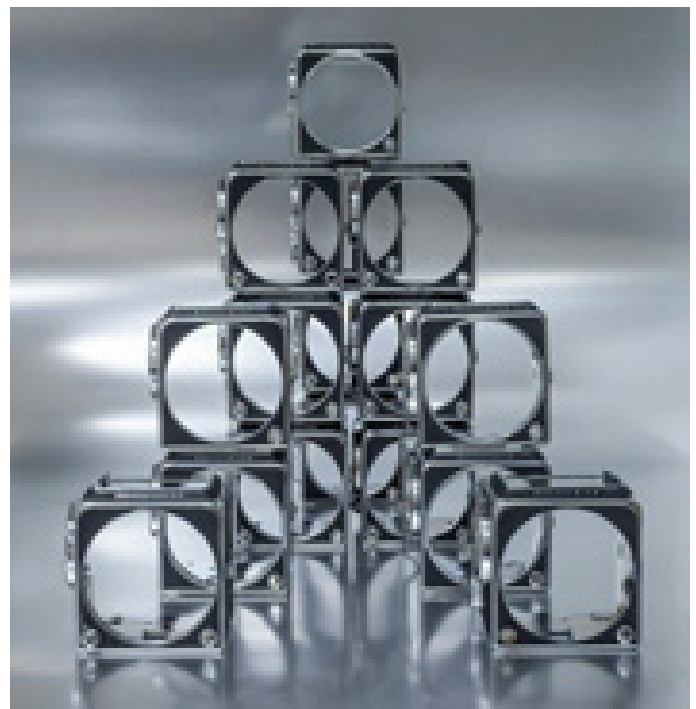

EXAMPLE 4 – WATCH

XCD 120 Macro lens.
 Subject distance: 50 cm
 Aperture: f/6.8
 Number of images: 80
 Step Size: Medium



FIXED EXPOSURE COMPENSATION SETTING

A fixed exposure compensation can be set by using the following method.

- 1 Tap the Exposure adjust setting on the control screen **(A)**.
- 2 Slide the white dot to the left or right to set the desired value for exposure compensation.
Tapping the line to the left or right of the dot, will increase or decrease the value with the value set in **Main Menu > Camera Settings > Exposure > Increment Step Size > exposure Adjust**.
Alternatively, you can use the front scroll wheel to set flash compensation and the rear scroll wheel to set fixed compensation.
The setting is saved as soon as it is changed.
- 3 Tap outside the rectangle **(B)** to return to control screen or half-press the shutter release to return to live view.
- 4 The compensation amount is shown on the control screen **(C)**. In live view, a '±' symbol **(D)** is displayed between the aperture and shutter speed setting as confirmation of the setting.

Note!

In the adjustment setting screen you can double-tap the  icon to reset the setting to 0.

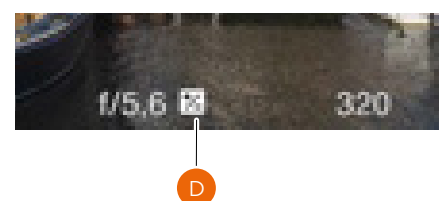
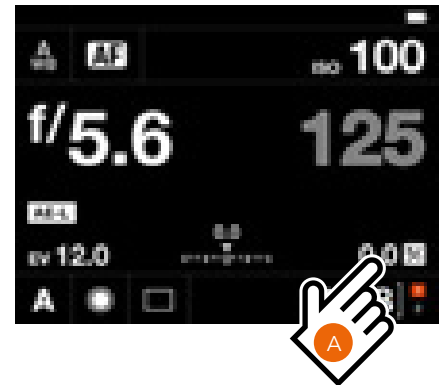

LIGHT METER MODE

The light meter mode can be changed on the control screen. Tap the desired mode or use the control wheel to select mode.

Different light metering modes

There are three reflective metering modes available.

- Centre Weighted.**
- Spot.**
- Centre Spot.**

Metering Modes



Symbol

Light Metering Modes



Centre Weighted

Used for light situations where there is no particular dominance of light or dark areas across the tonal range. Takes into account approximately 25% of the image seen in the viewfinder.



Spot

The sensitive area is equivalent to approximately 2.5% of the image area (the central spot on the viewfinder screen). Any parts of the image outside of this area will not affect the exposure reading. This provides a very accurate measurement of specific tones. Also excellent for tonal comparison measurements.

Spot area is marked in live view screen. The Spot area will follow any movement of the AF area.

Live View with Spot area

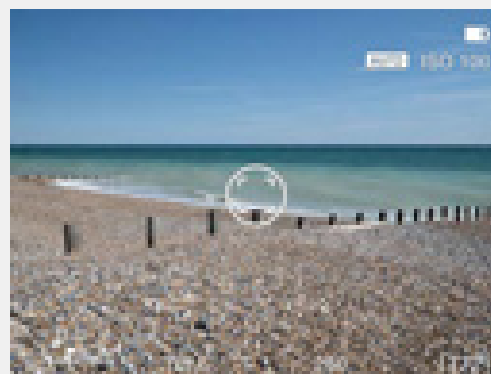

Centre Spot

Emphasizes the central section of the focusing screen equivalent to approximately 25% of the image. This provides a balanced assessment and is a typical choice where the main subject is in the centre of the image.

6.3 MEMORY CARDS

The camera uses SD cards only. See next page for a list of recommended cards.

There are two SD card slots on the camera, slot no 1 **(1)** and slot no 2 **(2)**.

Note!

All cards must be formatted in the camera before first use.

SD Memory card status display

The symbols in the status group **(4)** on the control screen:



1
2

No card is inserted.

1
2

Card #1 is inserted and is ready for captures.

1
2

Card #1 is inserted and is locked for captures as indicated by the secondary lock icon.

Additional secondary icons:

[0]

The card is full.



Card error.



Card read/write speed is slow.

Status group **(3)** normally displays the remaining captures, but can also show:



No card.



The card is locked.



The card is full.



Card error.



Backup mode selected, but no second card is inserted.

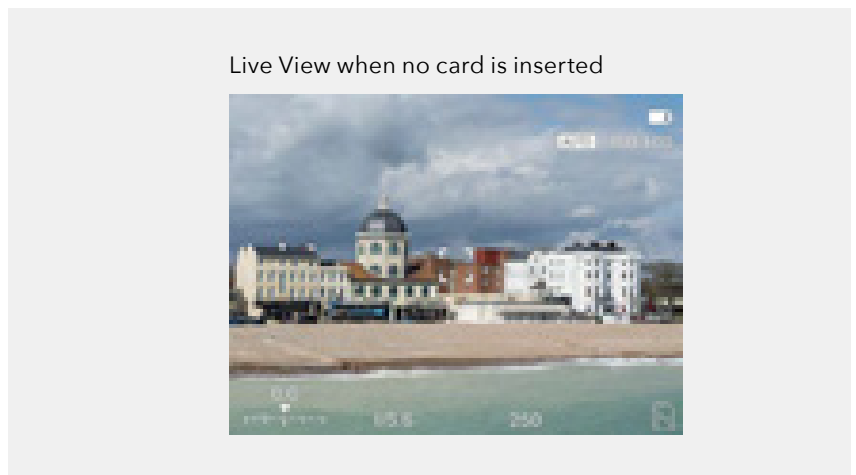
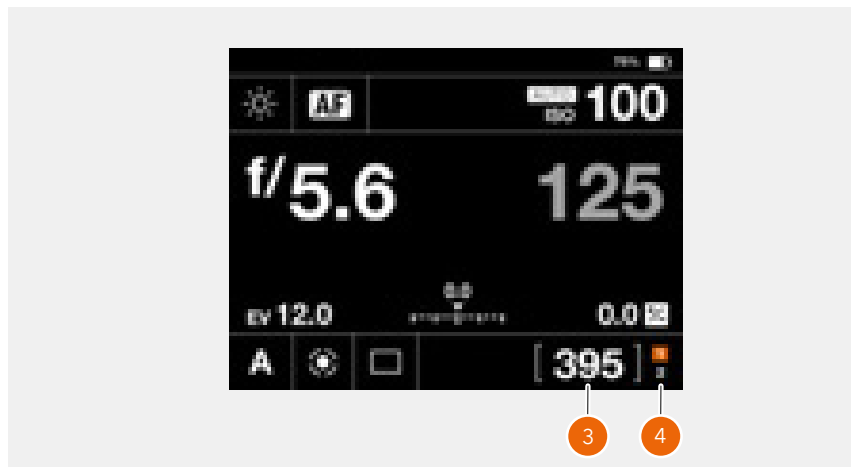

Live View when no card is inserted

INSERT THE SD MEMORY CARD

Insert SD card

- 1 Open the battery and SD card lid by sliding it towards the back of the camera and then rotate it outwards.
- 2 When the lid is opened, mount the SD card in the SD card slot no 1 or no 2 **(A)**.
- 3 Close the lid by rotating it inwards and pushing it in place towards the front of the camera **(B)** to lock it into position.

REMOVE THE SD MEMORY CARD

Note!

Do not remove a memory card from the camera if the Status LED **(C)** is blinking as this can corrupt the files on the card and result in data loss.

Remove SD card

- 1 Open the Battery and SD card lid.
- 2 Press the SD card a little way in and then release it. The SD card will then move out from the SD card slot.
- 3 Grab the card and pull it away from the camera.
- 4 Close the lid by rotating it counter clockwise and pushing it in place towards the front of the camera to lock it into position.

RECOMMENDED MEMORY CARDS

For optimal performance, use the following SD memory card type:

- UHS-II, 260MB/s or faster.

Note!

Avoid using Micro SD/TF memory cards with SD card sets. Some Sony high-speed G UHS-II SD 300MB/s memory cards might have poor compatibility, and therefore, might not be able to write image data properly.

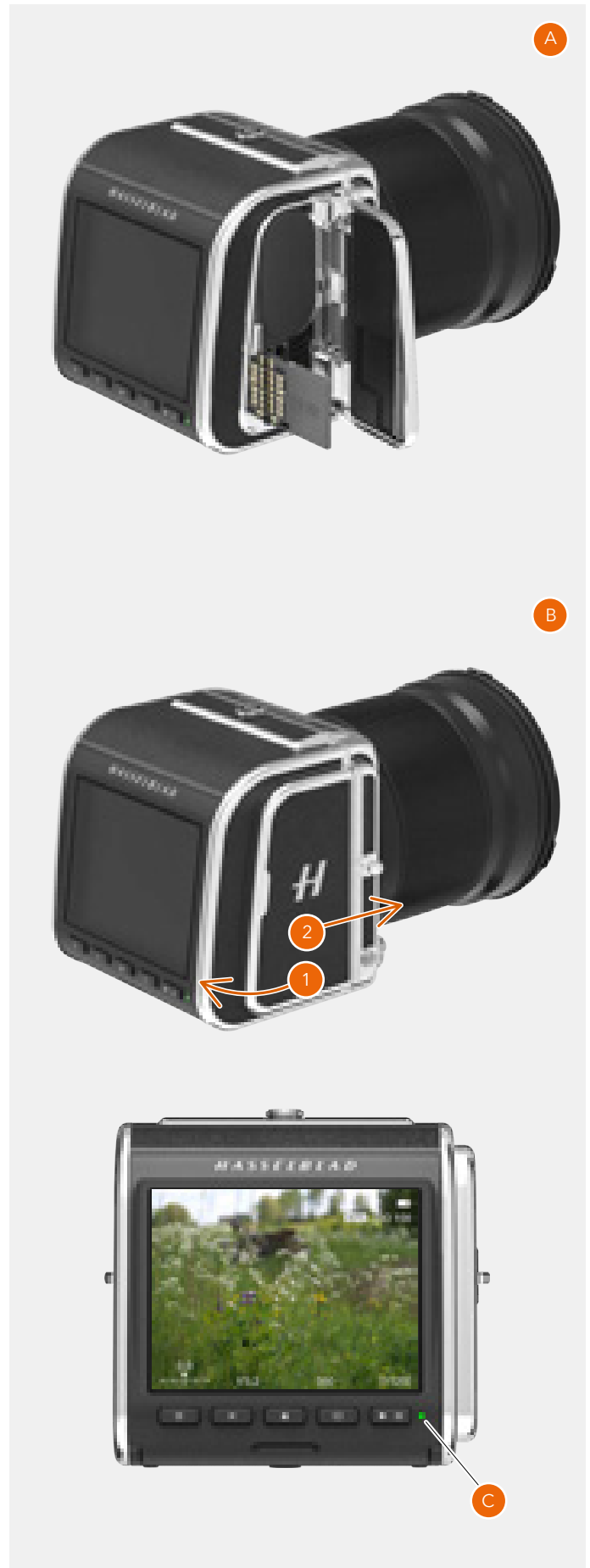

FORMAT SD CARDS

Note!

All SD memory cards should be formatted in the camera before using them for the first time.

Main Menu > General Settings > Storage > Format

- 1 Press MENU.
- 2 Select the General Settings menu **(A)**.
- 3 Navigate to Storage **(B)**.
- 4 Select "Format SD 1" **(C)** or "Format SD 2".
- 5 The Format Card dialogue appears.
- 6 To confirm, select Format by pressing the rectangle Button **(D)**. To exit without formatting, press the cross button **(E)**.

Note!

The storage shortcut is placed on the default main menu for easy access to card formatting. If the storage shortcut has been removed, see page 48 for more information on how to add shortcuts.

Main Menu



General Settings Menu

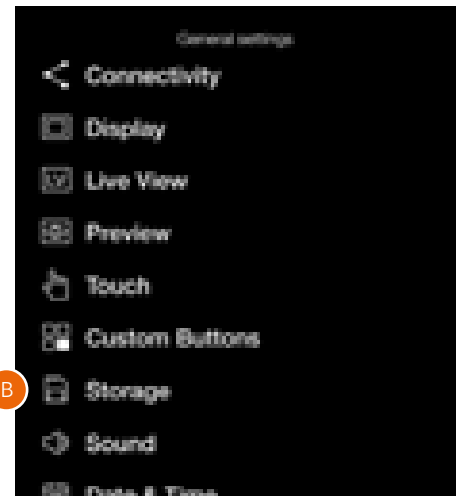

Storage Settings Menu

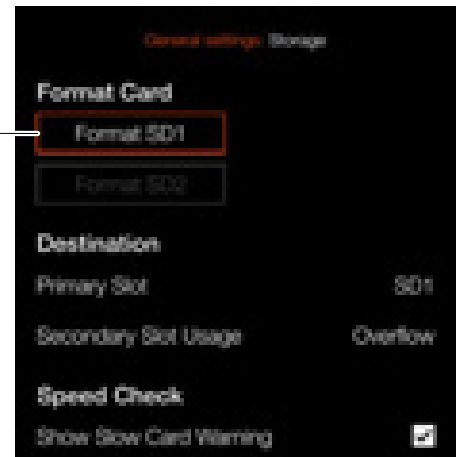

Format Card dialogue for SD1



6.4 LIVE VIEW INDICATIONS

The touch display can show live view including a number of different indications. This page lists the possible display information.

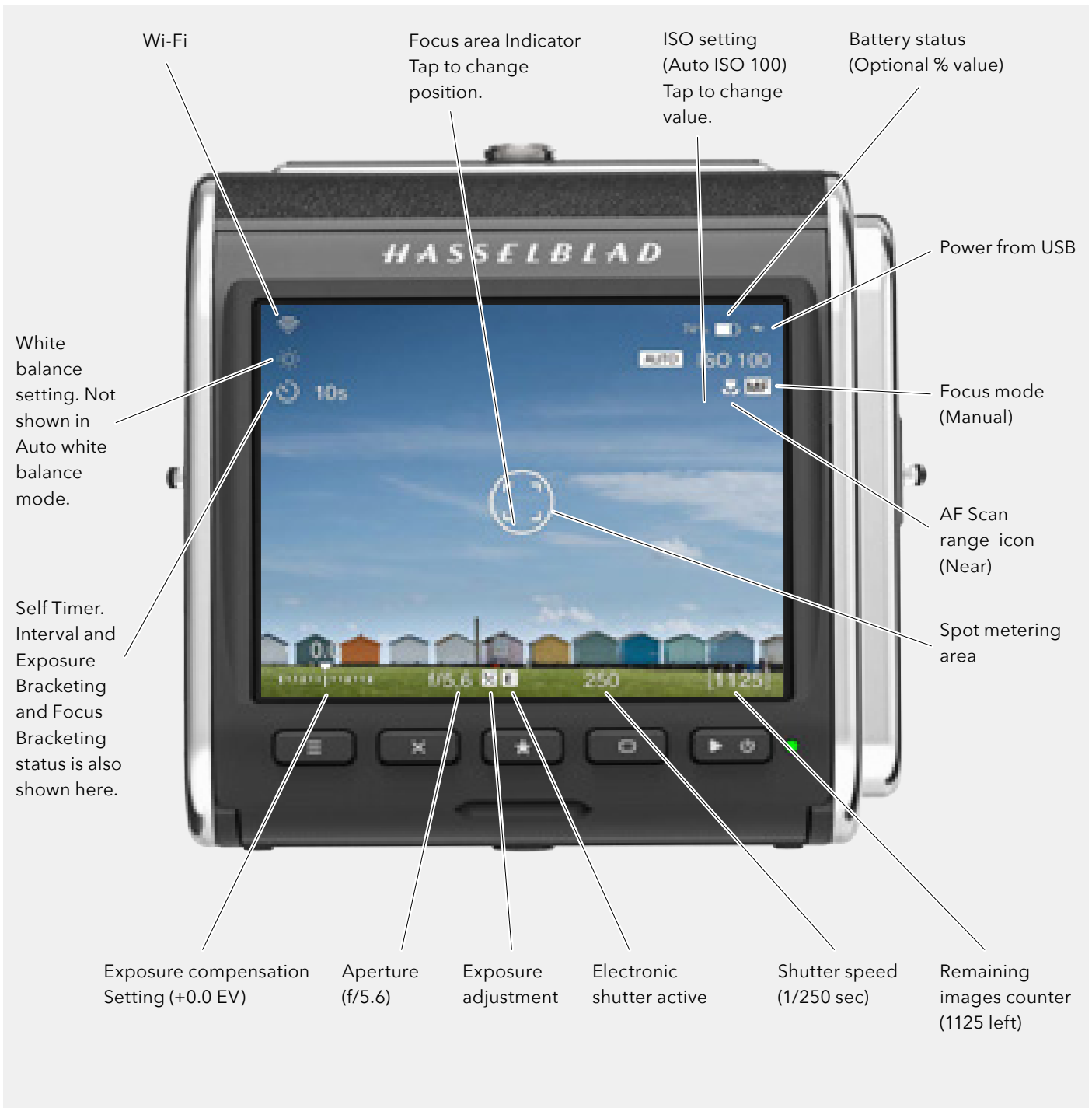

LIVE VIEW OVERLAYS

- 1 The camera displays live view when you half-press Shutter release button.
- 2 Press the rectangle button **(D)** to step to the next overlay.
- 3 Press button **A**, or **E**, to Exit Live View.

Available Overlays

- Exposure information **(F)**.
- Exposure information + Grid **(G)**.
- Exposure information + Spirit Level **(H)**.
See page 140 for details on spirit level.
- None **(I)**.

ZOOMING IN LIVE VIEW

- 1 Double tap the touch display, or press the star button **(C)** to Zoom in to 50% or 100% to that specific area. Magnification factor is set in the **Camera Settings > Focus** menu.
- 2 Double tap or press on the star button again to Zoom out to display the entire image.
- 3 You can pan the image when zoomed in by swiping.

Note!

Live view demands higher power consumption than normal operation. Working with live view will shorten the usage time of the battery.

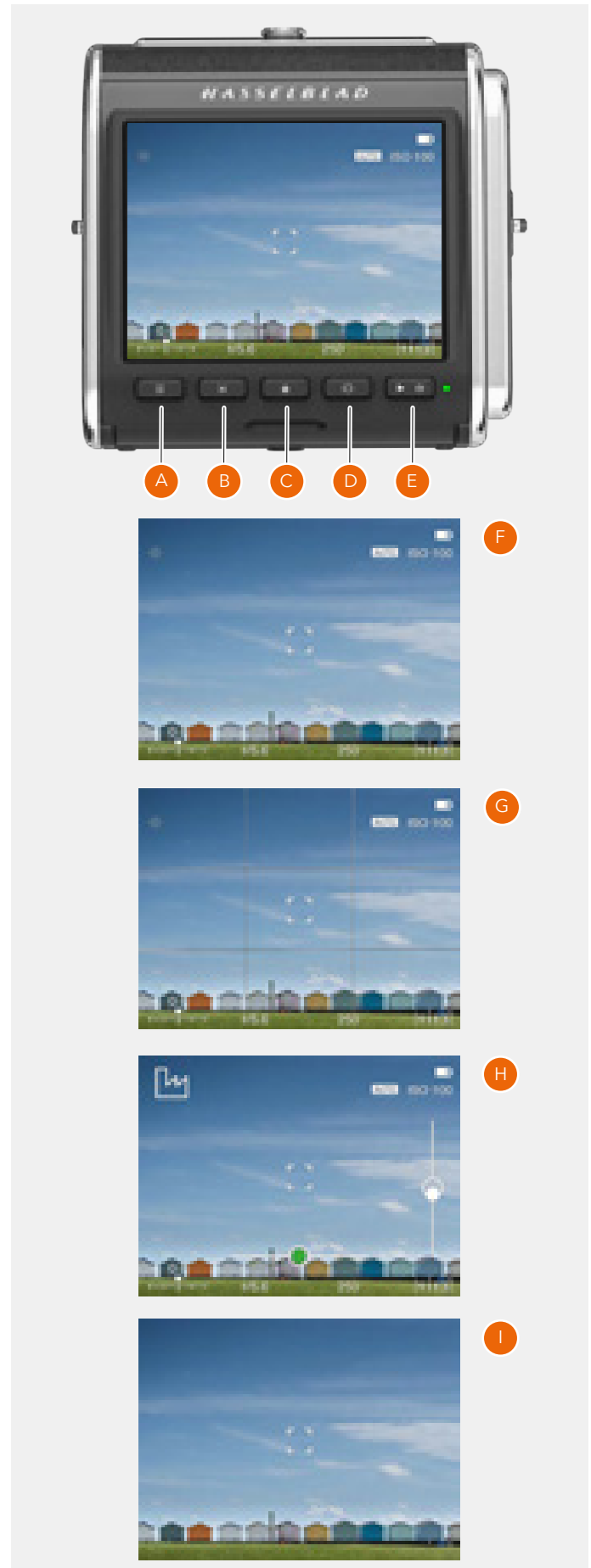

LIVE VIEW SETTINGS

From the live view screens **(A)** and **(C)** where ISO and white balance is shown, it is possible to directly set new values.

ISO

From the live view screen, tap the ISO **(1)** value to change. Select a new value from the list **(B)**.

White Balance

From the live view screen, tap the white balance icon **(2)** to change. See details on page 52.

Even if auto white balance (AWB) is set and no icon is shown, you can still tap in the upper left corner to bring up the white balance setting screen **(D)**.

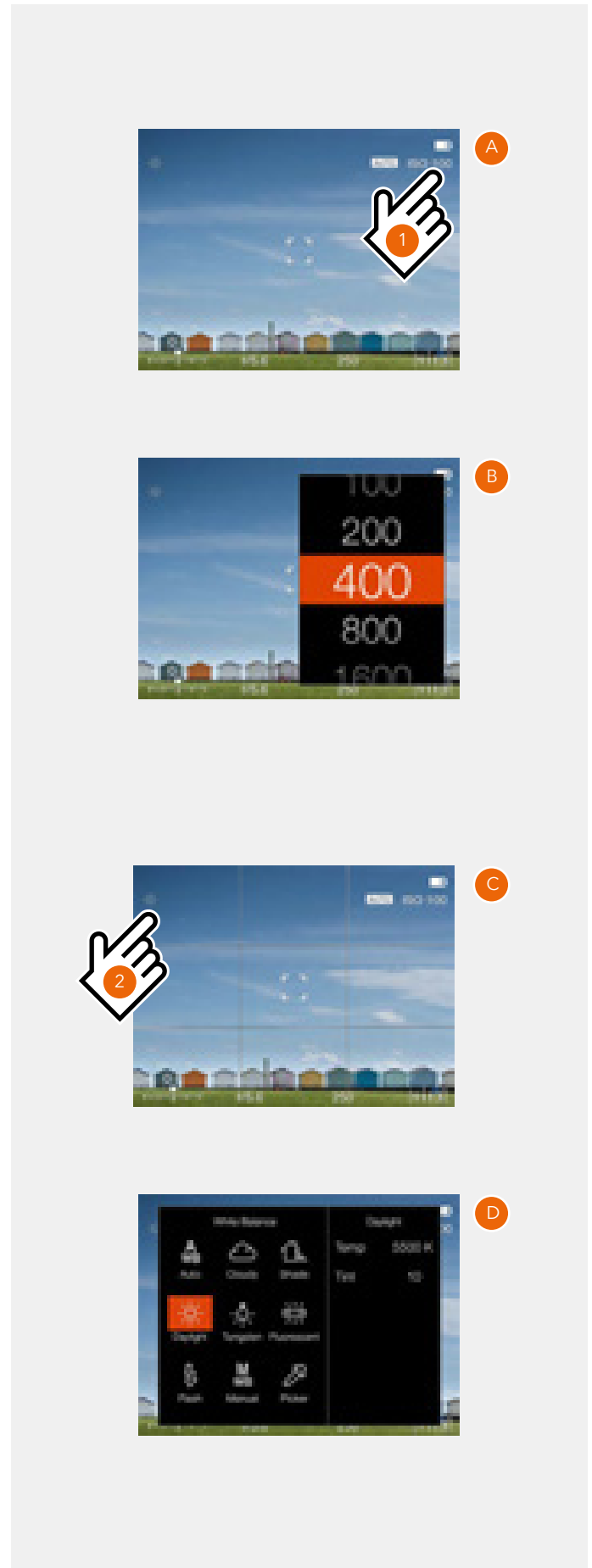

6.5 FOCUSING

AUTOFOCUS

Autofocus is activated by pressing the shutter release to the half-press position. Focus is determined by maximizing the contrast within the central marked area.

In AF mode, the shutter release will be blocked until the camera finds the optimum focus setting. This ensures that no captures are made that are not finely focused.

The lens will focus at one distance and will remain focused at that distance while pressure remains on the shutter release button **(A)**.

In this way, you can focus on a object, temporarily positioned within the focusing zone on the viewing screen and then without releasing pressure on the shutter release button, recompose knowing that the focus remains on the object chosen even though it is now outside the focusing zone.

Releasing the pressure on the shutter release button and pressing again (half-press) would now change the focus setting to the distance of the object within the focusing zone.

Depending on situation, the indicated AF area looks different. See page 77.

Note!

For objects close to the camera and/or with wide-angle lenses it is better to move the AF point as described on page 80.

Note!

You can select position of the AF point. See page 80. It is also possible to choose from three different sizes. See page 120.

Note!

H System lenses whose firmware version is older than 18.0.0 have hardware that cannot be updated with AF functionality. The camera will default to manual focus mode for these lenses.

Using H System lenses on the 907X camera requires the optional XH Lens adapter.

White AF indicator. AF is idle.

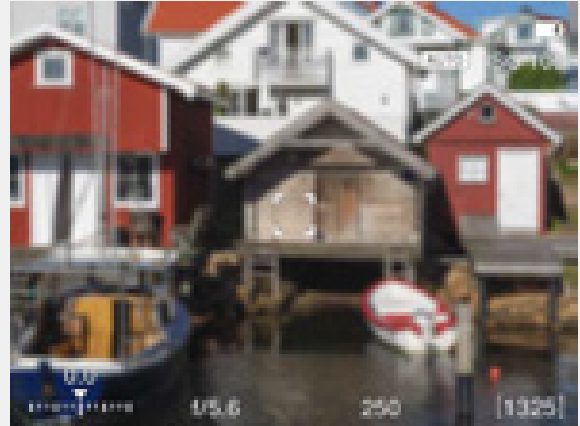

Green AF indicator. AF is set correctly.

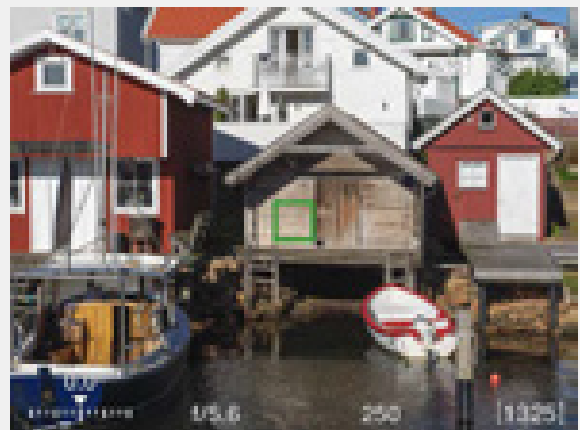

AF INDICATIONS

The AF indicator in the live view centre indicates status of the AF system. Start the autofocus function by a soft half-press on the shutter release Button.

White, black outline (1)

Normal mode. Autofocus is not analysing the subject.

Black, white outline (2)

Autofocus is ongoing.

Green (3)

Autofocus performed and focus is correctly set.

Red (4)

Autofocus failed to focus and is not correctly set.

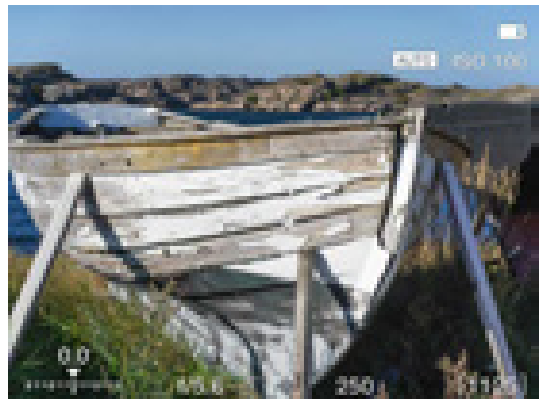

White AF indicator. Normal mode.



Green AF indicator. AF correctly set.

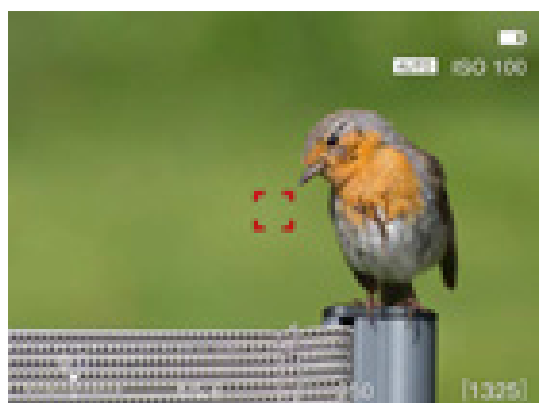

Red AF indicator. AF analysis failed to focus.

1

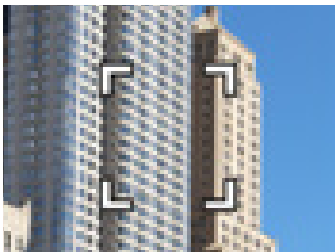

2

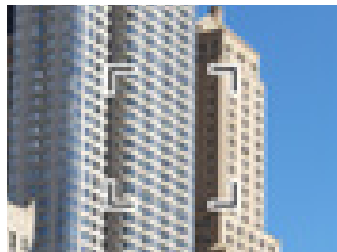

3

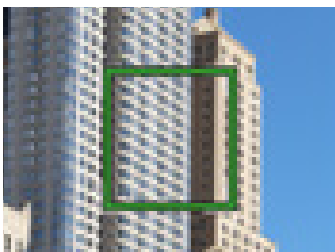

4

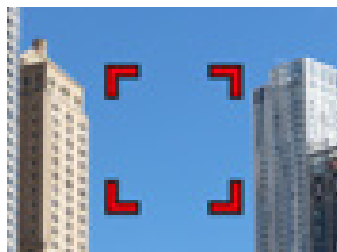

MANUAL FOCUS

Manual focus setting

Manual focus can be used at any time even in auto focus mode by rotating the focusing ring on the lens. You can also switch to manual focus mode (MF) and only use the focusing ring manually.

Manual focus in live view

- 1 Double tap the touch display to zoom in to selected Focus area, or press the star button to zoom in to the image centre.
- 2 Adjust focus manually on the Lens.
Note that you have two focus assist options to help you set focus accurately.

- Auto zoom to 50% or 100%. See page 75.
- Focus peaking (see next page)

In Auto zoom live view will automatically zoom to 50% or 100% when the focus ring is turned. After a few seconds of inactivity, Live view returns to full image.

- 3 Double tap or press on the star button again to zoom out to display the entire capture.

Using these modes will ensure accurate and precise focusing. Auto zoom is the most accurate and focus peaking is the fastest to use.

Live View



Auto Zoom to 50%. Subject not in focus.

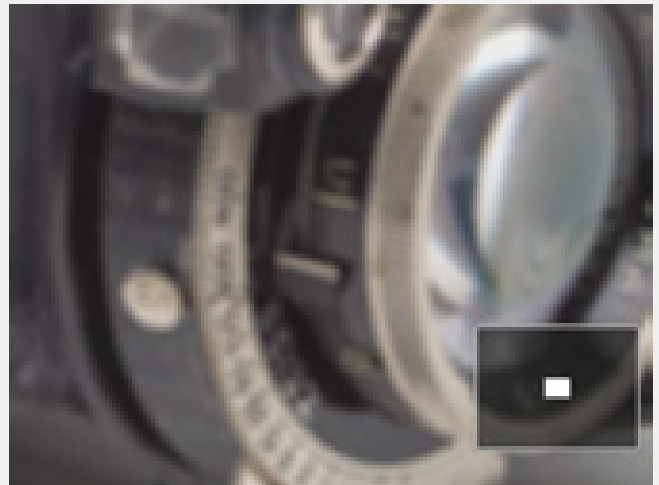

Auto zoom to 50%. Focus set correctly.



FOCUS PEAKING

Subject is not in focus



Main parts of the subject are in focus



How to use Focus peaking

The Focus peaking function is a manual focus tool to help you identify which areas of the subject that are in focus. Focus peaking is not active in auto focus mode.

When focus peaking is active and you adjust the focus manually, areas in focus (orange in this case) moves in depth as you move the focus position.

See more on Focus settings on page 120.

6.6 MOVE AUTOFOCUS POINT

If the setting **Move AF Point** in the **General Settings - Touch** menu is checked it is possible to set the AF point location by pointing at the area.

Procedure:

- 1 Activate Live View by half-pressing the shutter release button. The AF point is in the centre **(A)**.
- 2 Aim the camera at the subject and tap the new location for the AF point **(B)**.
- 3 The AF point will remain in this location until changed **(C)**.

Note!

If spot metering is selected, the sensitive light metering area will follow the AF point.

Note!

You can set the camera to automatically reset the focus point to the centre position after each capture, or maintain the selected position in **Main Menu > Camera Settings > Focus > Reset Focus Point**. See page 120.

6.7 RESIZE AUTOFOCUS POINT

The autofocus point can be resized in the Focus menu as described on page 120. See also page 81.

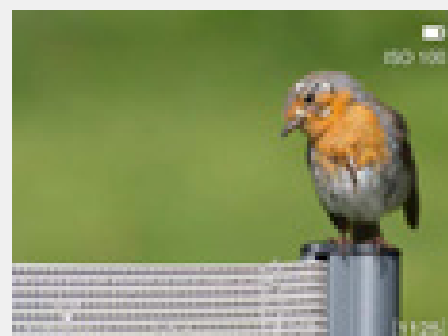
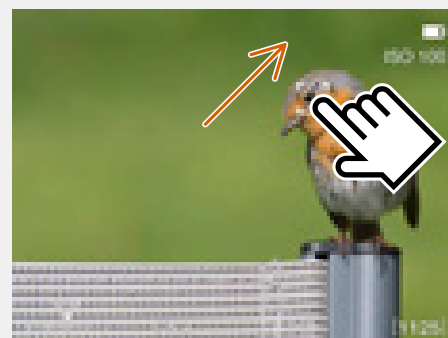
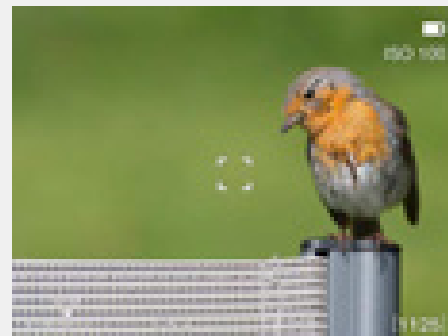
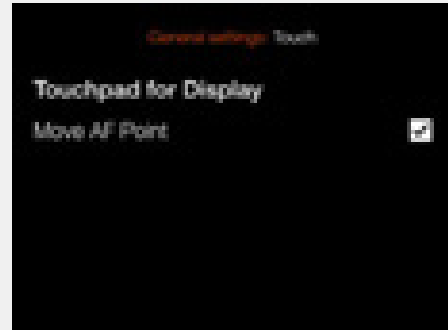

MENU SCREEN NAVIGATION

All settings of the camera are available in the menu system which is entered by clicking one of the three icons at the bottom of the screen.

You can use the menu system either by using touch or by using the buttons as described on the next page.

Example using touch

- Press the menu button **(1)** to show the main menu.
- Tap the Camera Settings icon **(2)**
- The menu screen for camera settings appears **(A)**.
- Tap Focus **(3)**.
- The camera focus settings screen appears **(B)**
- To select AF point size, tap anywhere on this line **(4)**
- Select the desired size by swiping the list **(C)**
- The display will return to the main menu screen **(A)**
- To exit without saving the setting, press the menu button **(1)**



Example Using buttons

Three buttons are used for menu navigation:

- Cross button  Move selection up
- Star button  Enter
- Rectangle button  Move selection down

Use the following procedure:

- Press the menu button **(1)** to show the main menu **(A)**
- Press the cross button **(2)** to enter the camera settings Menu **(B)**.
- Press the rectangle button **(H)** to highlight the item **Focus**.
- Press the star button **(3)** to enter the Focus settings **(C)**.
- Press the rectangle button **(4)** to highlight the middle item (AF Point Size). Press the star button **(3)** to enter the setting **(D)**.
- Use the rectangle button **(4)** to move the selection down and the cross button **(2)** to move up. When the desired size is selected, press the star button **(3)** to make the selection.



6.8 BROWSING, PREVIEW AND HISTOGRAM

BROWSING IMAGES

To enter browse mode, short-press the Play/On-Off button **(C)**.

In browse mode, swipe right or left or use the control wheel **(D)** on the camera grip to browse captures in a folder.

Zoom out to folder view to select another folder to browse as described on page 85.

Press Shutter release button **(E)** to exit browse mode or press the menu button **(A)**.

Access the delete Image dialogue by pressing the cross button **(B)**. See page 87.

Continued on the next page.



ZOOMING

You can zoom in to the preview image in two ways:

- Spread zoom **(A)**, where you place two fingers together on the display and then move them apart. This will create a step-free zoom in effect up to 100% (one pixel in the image = one pixel on the display)
- By double-tapping the display. This will directly zoom in to 50 or 100%, depending on the setting **Zoom Level** in the **Camera Settings > Focus** menu. See page 75.

BROWSING IMAGES – NINE-VIEW

If you Pinch-zoom **(B)** (move two fingers together on the screen), nine images will be shown at the same time. If Image rating is turned off (see page 125), you can also press the star button **(1)**.

To view another image in one-view, just tap the small thumbnail. If card contains many images on the card, you can swipe vertically **(C)**.

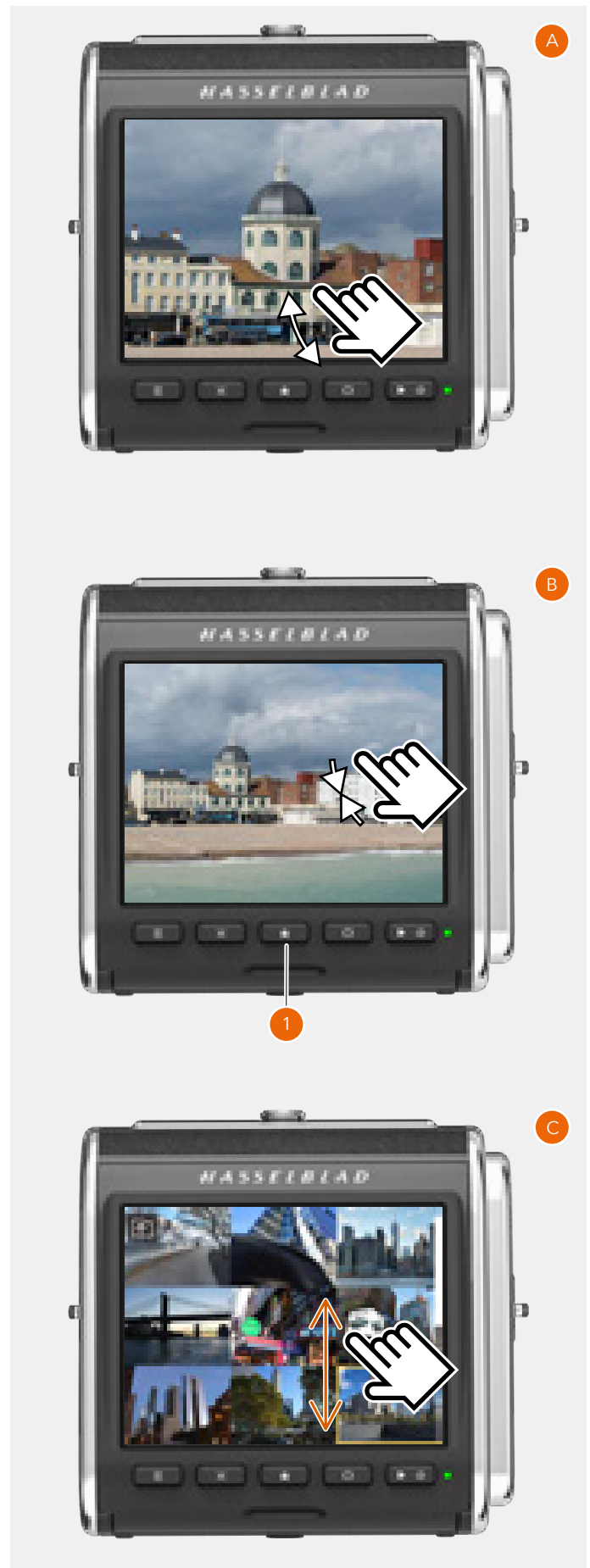

SELECT FOLDER TO BROWSE

You can select any of the folders on the card to browse images.

To select which folder to view, navigate up in the folder structure until you reach the folder level **(3)** dialogue. The folder structure is the following:

- Memory cards
- Folders
- 9 images
- 1 image

It is possible to navigate to the card selection dialogue either using touch or buttons and scroll-wheels.

- 1 When viewing one image **(1)** Pinch inwards to go to the 9 images view **(2)**.
- 2 In the 9 images view - Tap the "Folder Up" button **(A)** in the top left corner to go to folders.
- 3 In the folders view **(3)** - Select folder by tapping the folder name.
- 4 Select the image you want to view from the 9 images view.

The selected image is shown.

SELECT CARD TO BROWSE

You can select SD 1 Card or SD 2 card to browse images.

To select which card to review, navigate up in the folder structure until you reach the "Select Card to Browse" dialogue **(4)**.

- 1 Select folder by clicking the folder name (322HASBL) **(5)**.
- 2 Select the image you want to view from the 9 images view **(6)**.
- 3 The selected image is shown **(7)**.

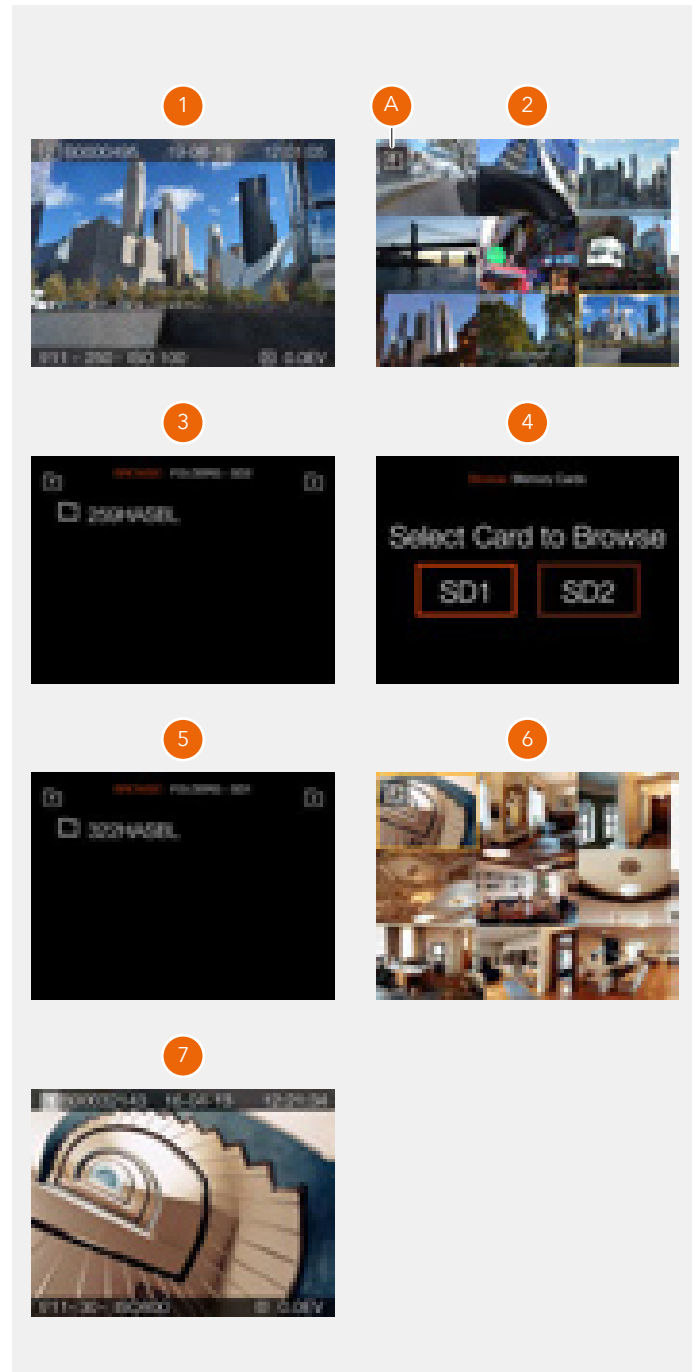

CREATE NEW FOLDER

It is possible to create a new folder on the currently active SD card. When a new folder is created, all new images will be stored in that folder. The folder name is auto-generated and cannot be changed.

It is not possible to store images in a previous folder.

By touch:

- 1 When viewing one image **(A)**, pinch inwards to go to the 9 images view **(C)**. You can also press the star button.
- 2 In the 9 images view - Tap the "Folder Up" button **(B)** in the top left corner to go to folders.
- 3 In the folders view - tap the "Add folder" button **(D)** in the top right corner to create a new folder.
- 4 In the Create Folder dialogue **(E)**, choose **Create** to create a new folder or **Exit** to skip.

When the new folder (101HASBL) is created, the folder view **(F)** will show the new folder. To view images in the previous folder (100HASBL), proceed as described on page 85. New images will automatically be stored in the new folder.

Note!

It is only possible to create a new folder on the currently active card. When browsing the other card, the "Add Folder" icon will not be available.

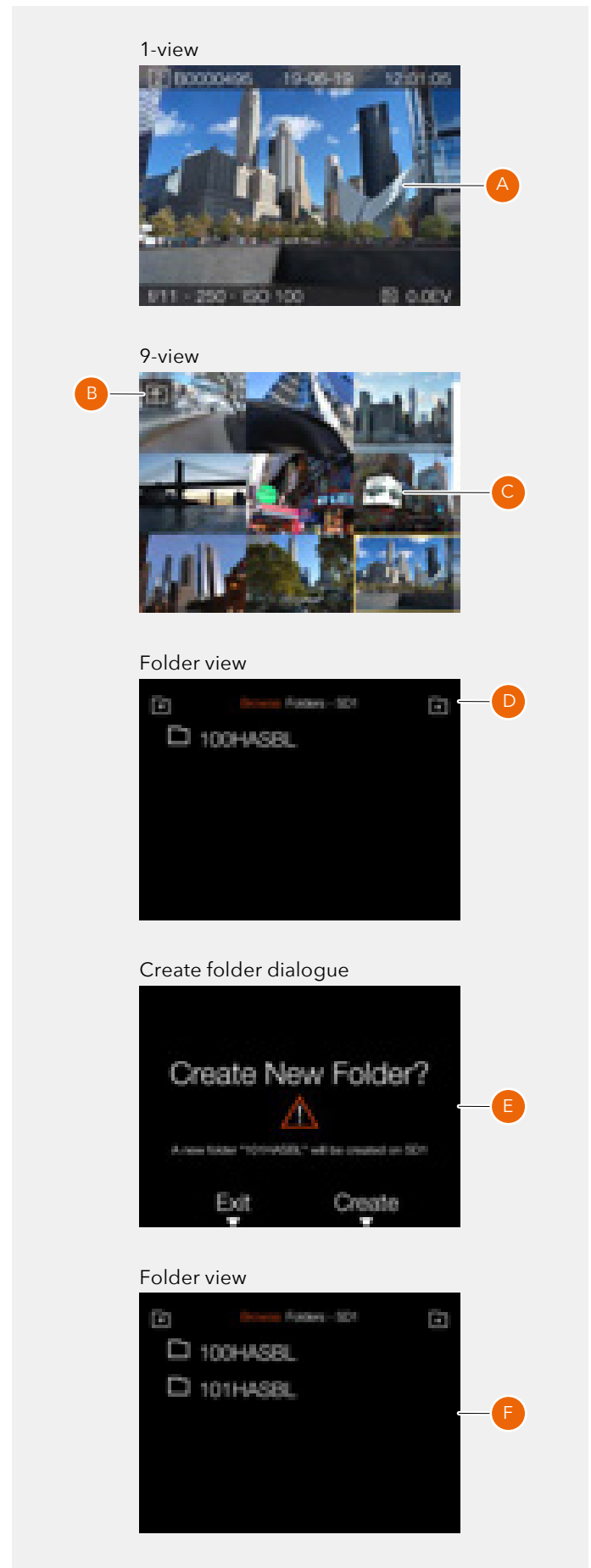

DELETE IMAGES

An image can be deleted from the card by pressing the cross button **(1)** in one view browse mode **(A)**. This will bring up the delete dialogue **(B)**.

To delete the image, press the rectangle button **(2)**. To exit the dialogue without deleting the image, press the cross button **(1)**. This will return to browse mode **(C)** Showing the next image. If the deleted image was the last captured image, the previous image is shown.

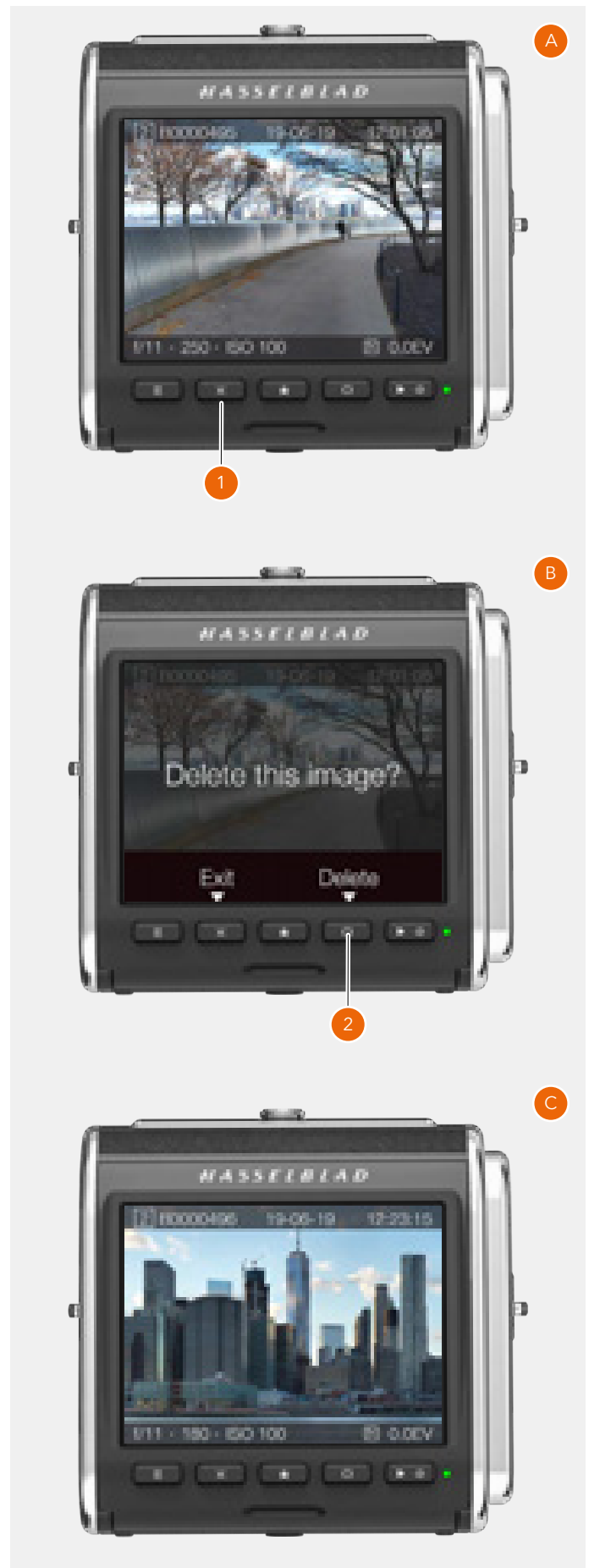

BROWSE OVERLAYS

In one-view, you can change information overlay by clicking the rectangle button . Continue clicking to step through the available options.

The following options are available:

- Standard (A)
- Full screen (B)
- Detailed info (C)
- Separate histogram (D)
- Luminance histogram (E)

Information on the screen:

- | | |
|---------------------------|----------------------|
| • Active card (1) | • Capture date (7) |
| • Image name (2) | • Capture time (8) |
| • Aperture (3) | • Exposure mode (9) |
| • Shutter speed (4) | • Metering mode (10) |
| • ISO (5) | • White balance (11) |
| • Exposure adjustment (6) | • Focal length (12) |

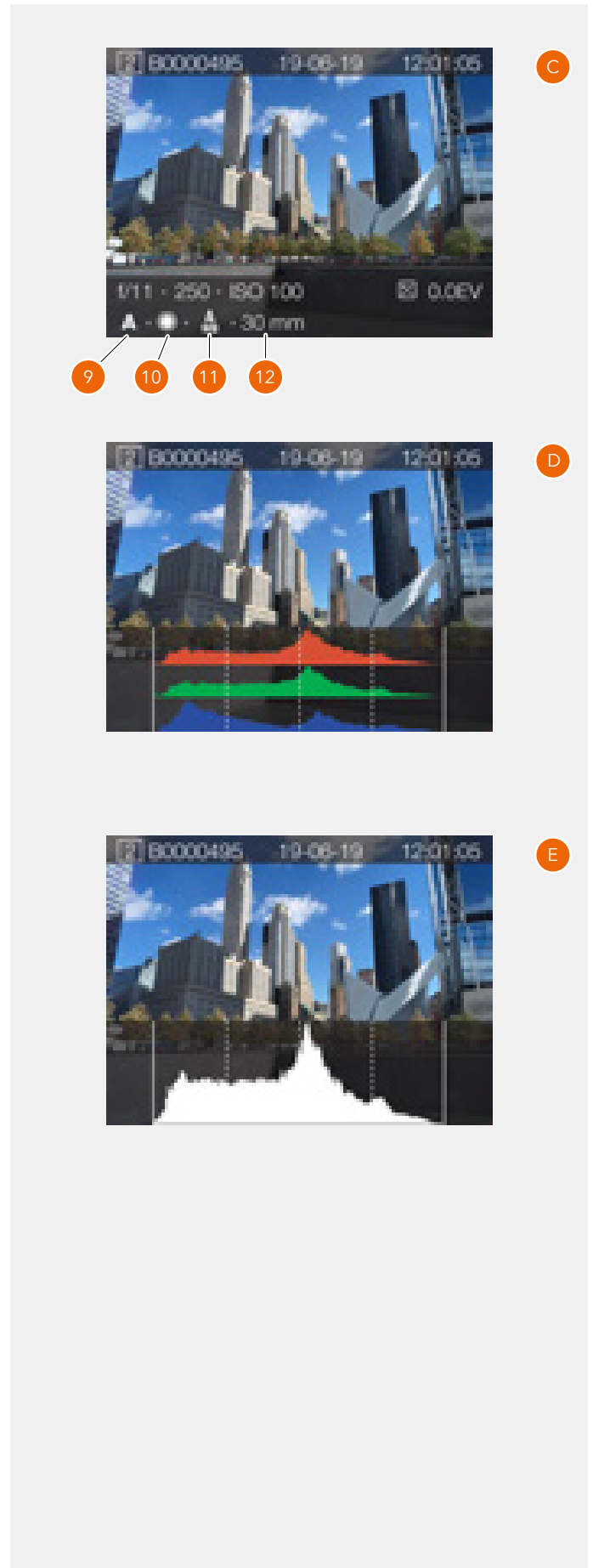
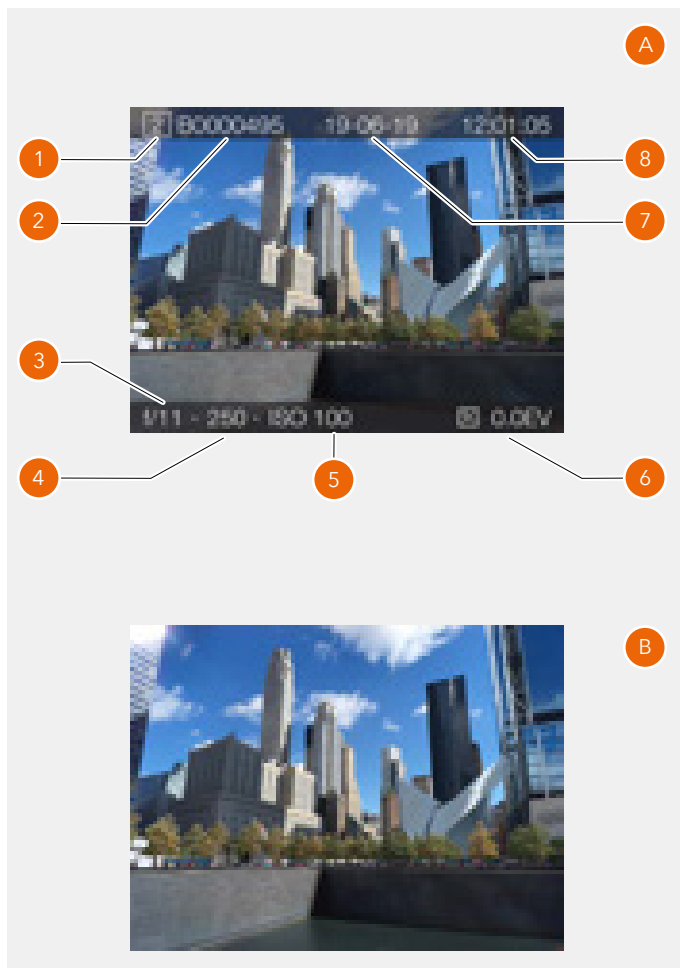

HISTOGRAMS

The histogram provides a graph that indicates the total number of pixels at each brightness level, with brightness in range from black on the left to white on the right. It is a valuable tool for evaluating captures.

A well exposed shot usually has a full range of levels, while underexposed and overexposed captures tend to show levels concentrated at the left or right part of the scale.

The histogram is only an indicator that should be interpreted. There are several situations in which a 'bad' histogram will match an exposure that could be perfect for the intended effect.

Underexposure (A)

Histogram display concentrated on the left with few pixels elsewhere indicates a likely underexposure. Many details will be lost in the shadows.

Even exposure (B)

Histogram display spread across the full range indicates a likely good exposure. There may still be a few pixels at the extremes, indicating a few spectral highlights and saturated shadows, but this is often normal in a good exposure.

Overexposure (C)

Histogram display concentrated on the right with few pixels elsewhere indicates a likely overexposure. Many details will be lost in the highlights.

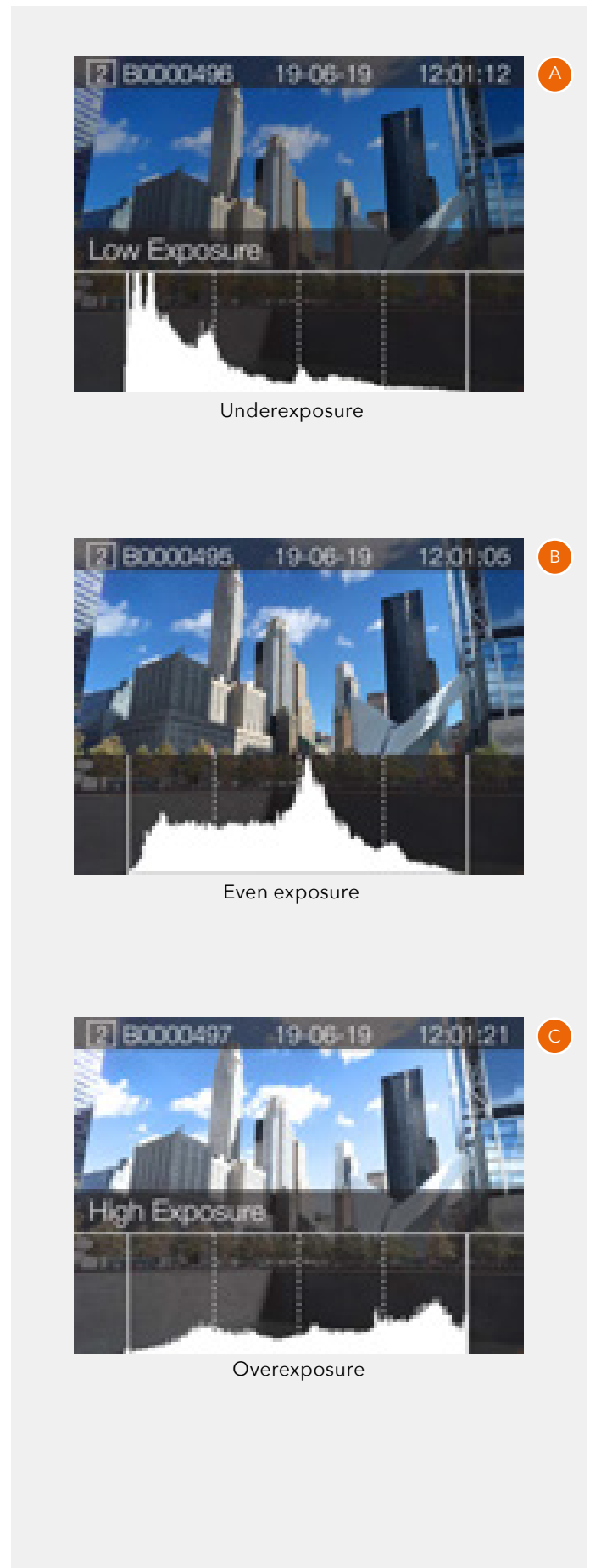

6.9 IMAGE RATING

RATING FUNCTION

Images on the memory card, can be rated from 1 to 5 Stars. The rating is written to the meta-data of the image file. Use the following procedure.

- 1 Make sure that the setting "Image Rating" in the **Camera Settings > Configuration** menu is checked. See page 125.
- 2 Press the Play button to enter Browse Mode.
- 3 Select the Capture Details overlay by pressing the Display Button or by rotating the rear Scroll Wheel **(A)**.
- 4 In the lower right part, the 5 stars **(B)** show the current rating. For images that are not rated, no stars are filled.
- 5 To rate the image, tap the five stars **(B)** or press the Star Button.
- 6 The camera enters Rating Mode, showing five large stars. If the image has been rated before, it will show the current rating, otherwise, the five stars will be empty.
- 7 Tap the desired star to change rating. E.g. if you want a 4-star rating, tap the fourth star **(C)**. The Rectangle Button increases rating and the Cross Button decreases rating. You can also use the rear Scroll Wheel to change rating.
- 8 To return to Browse Mode **(D)**, press the Star Button or the Browse Button again.

Rating Mode is equivalent to standard Browse Mode, which means that you can browse to the next image by swiping the display or using the front Scroll Wheel. Double-tap the screen to Zoom-in.

You can always go back to a previously rated image and change rating following the same procedure as above.

Note!

For an efficient work-flow while rating many images, stay in Rating mode and swipe to the next or previous image. It is also possible to use the front scroll wheel to go to the next or previous image while in Rating mode.

Note!

If image rating is deactivated in the setting **Camera Settings > Configuration > Image Rating**, the five stars in Browse Mode **(A)** will not be visible.

Note!

If two cards are inserted, only images on the primary card are rated.

Note!

Video files cannot be rated.

Browse mode - Capture Details Overlay

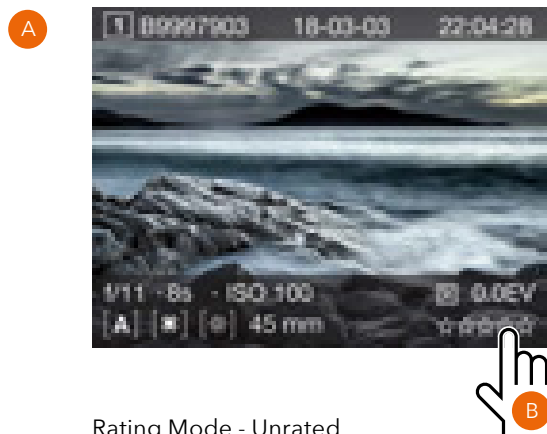

Rating Mode - Unrated

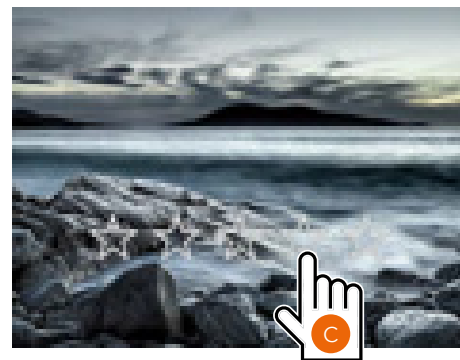

Rating Mode - Rated 4 stars



Browse Mode - Rated 4 stars.



6.10 VIDEO RECORDING

HOW TO RECORD VIDEO

First select Video Settings in the Video Settings Menu. See page 126.

- For best result, use a stable tripod with the camera when recording video.
- For best quality of the recorded sound we recommend using an active microphone.
- The maximum length of one video clip is 29:59 minutes. The number of video clips possible to save, depends on the capacity of the inserted SD memory card. Remaining capacity is displayed on the control screen (D).

- 1 From the Control Screen , tap the Exposure mode icon (A).
- 2 Tap the Video icon (B).
- 1 The Video Control Screen (C) is displayed on the Touch Display.
- 2 Start the Video Live View by half-pressing the shutter release button (A). If you want to stop Live View without capturing video, click the Menu button.
- 3 The Video Live View screen is displayed on the Display.
- 4 Start Recording by fully pressing the Shutter Release Button or by tapping the red recording icon (E) on the Touch Display. The recording icon is replaced by a grey stop icon (F) during recording.
- 5 Stop the Recording by pressing the Shutter Release Button or by pressing the grey stop icon (F) on the Touch Display.

Note!

You can change ISO and White Balance from both Video Control Screen and Video Live View screen by tapping the values.

Note!

Video recording is not possible in tethered mode.

Control Screen



Exposure Mode setting

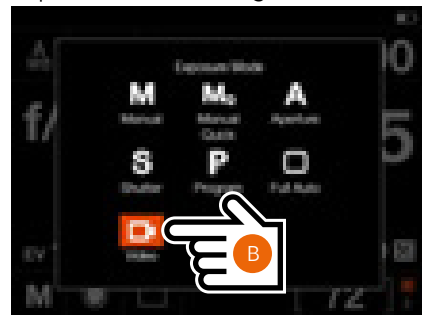

Control Screen in video mode



Video Live View Screen

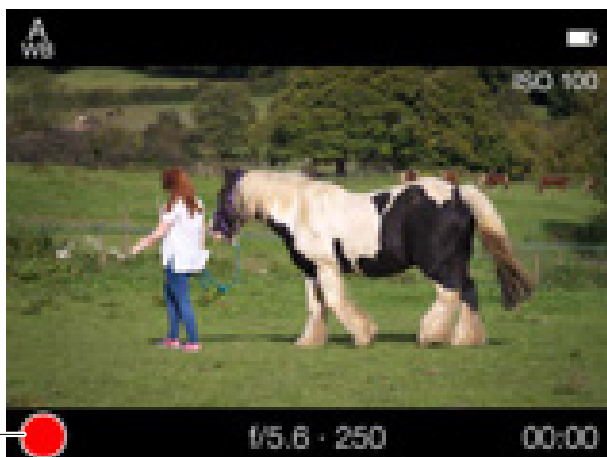

Video Display when capturing video

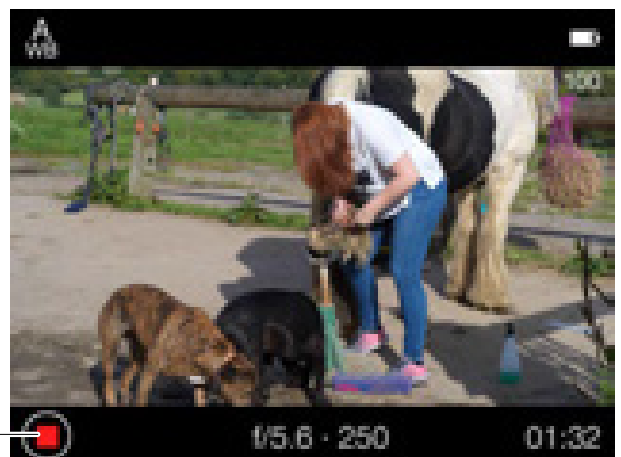



HOW TO VIEW RECORDED VIDEO

- 1 Press the Browse button (A).
- 2 The recorded videos are displayed with a preview image and a Play icon.
- 3 Select video to view.
- 4 Press the Play icon (B) on the Touch Display (white triangle) to playback the selected Video.
- 5 To pause the video, tap the screen again. Tap the pause icon (C) to start again.
- 6 By sliding the white dot in the progress bar to the left or right, you can fast forward or reverse to quickly view other parts of the video.

Note!

Video files cannot be rated.

Screen during video playback

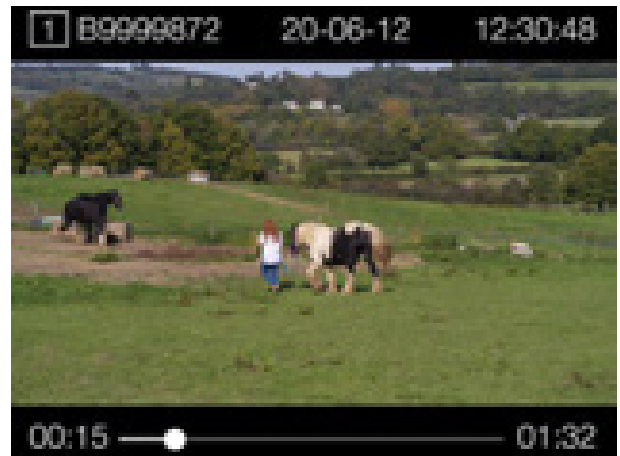

Screen when video is paused



7.1 907X CONTROL GRIP

Available as an optional accessory, the control grip makes the 907X camera even easier and more convenient to use by adding dedicated buttons, scroll wheels and a joystick.



PARTS AND CONTROLS

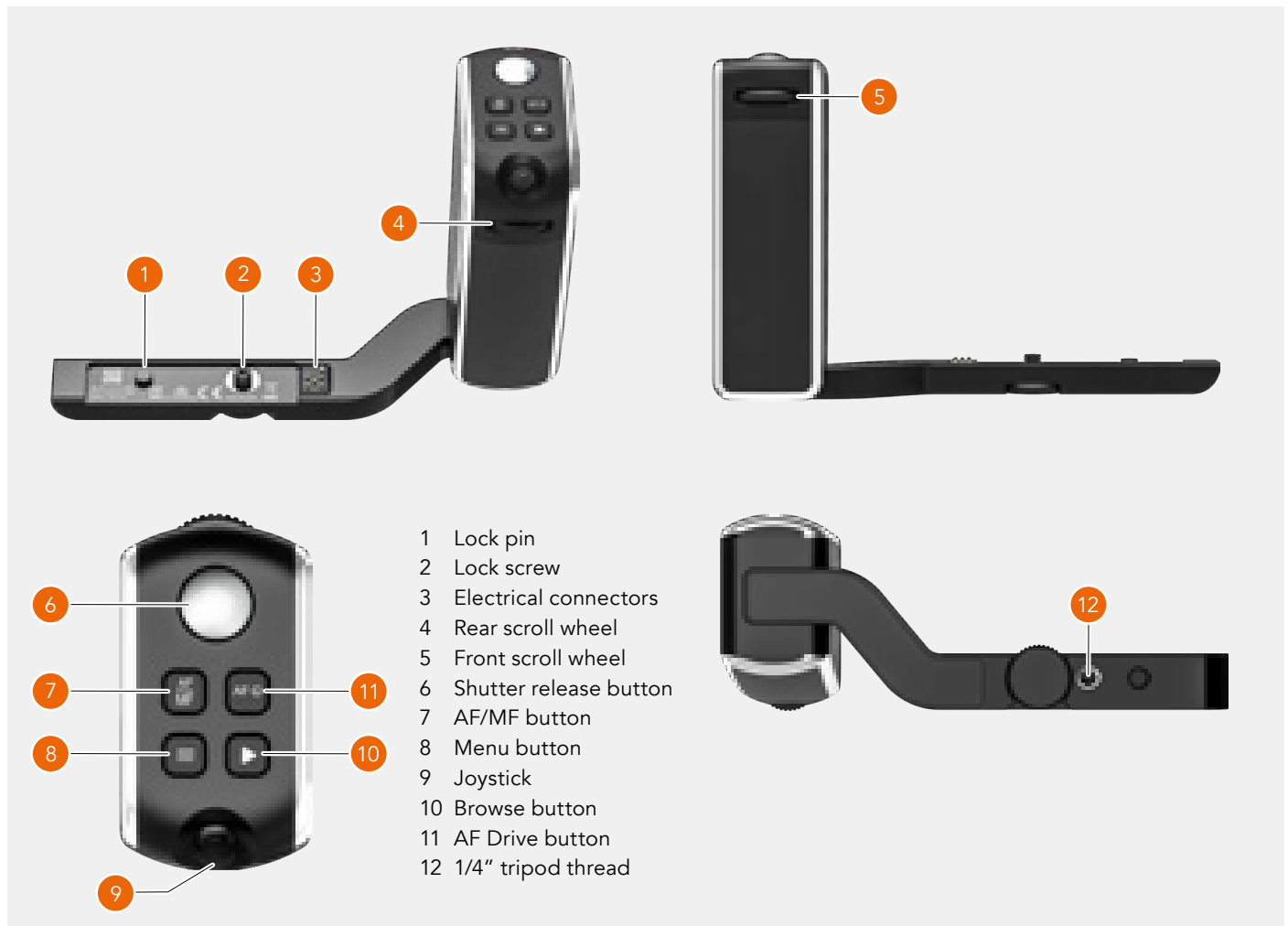

Functions of buttons and controls are described on page 96.

ATTACHING THE CONTROL GRIP

Place the camera upside-down with the lens mount facing you.

- 1 Align the lock pin **(A)** and lock screw **(B)** as shown below.
- 2 Make sure you insert the lock screw in the correct hole.
- 3 Tighten the lock screw securely **(C)** by hand.



USING THE CONTROL GRIP

Buttons and controls

1 Front scroll wheel

The front and Rear Scroll Wheels are used to make changes in exposure settings, navigate the Touch Display Menu as well as acting as browse controls. See bottom right table.

2 Shutter release button

This button has two positions. Press half way (or soft) to activate the camera, auto focus function and exposure meter. Press all the way down (or more firm) to release the shutter. The chosen exposure procedure and the self timer are also activated with this button.

3 AF/MF button

The AF/MF button toggles between Autofocus and Manual Focus mode.

4 Menu button

This button opens the Main Menu. If the Main Menu is already active, the Control Screen is shown.

5 Joystick

Used for different tasks depending on mode. See more on page 97.

6 Rear scroll wheel

The scroll wheel is used to make changes in exposure settings, to navigate the Camera menus as well as acting as browse control. See bottom right table.

7 Browse button

Activates the display and shows the last image. The user can review images, browse and zoom. Preview images and zoom in to view close-ups of previews for focus checking. Zoom out to view several at once and finally to view and select folders and media.

8 AF Drive button

The AF Drive button (AF-D) starts the Autofocus process. Press to start Autofocus and release to stop the Autofocus function.

Note!

You can set the camera to Stand-by mode to save power by pressing the Menu button (4) and the Browse button (7) at the same time.

Note!

The four top buttons (3, 4, 7 and 8) can be reprogrammed to a different function as described on page 134.

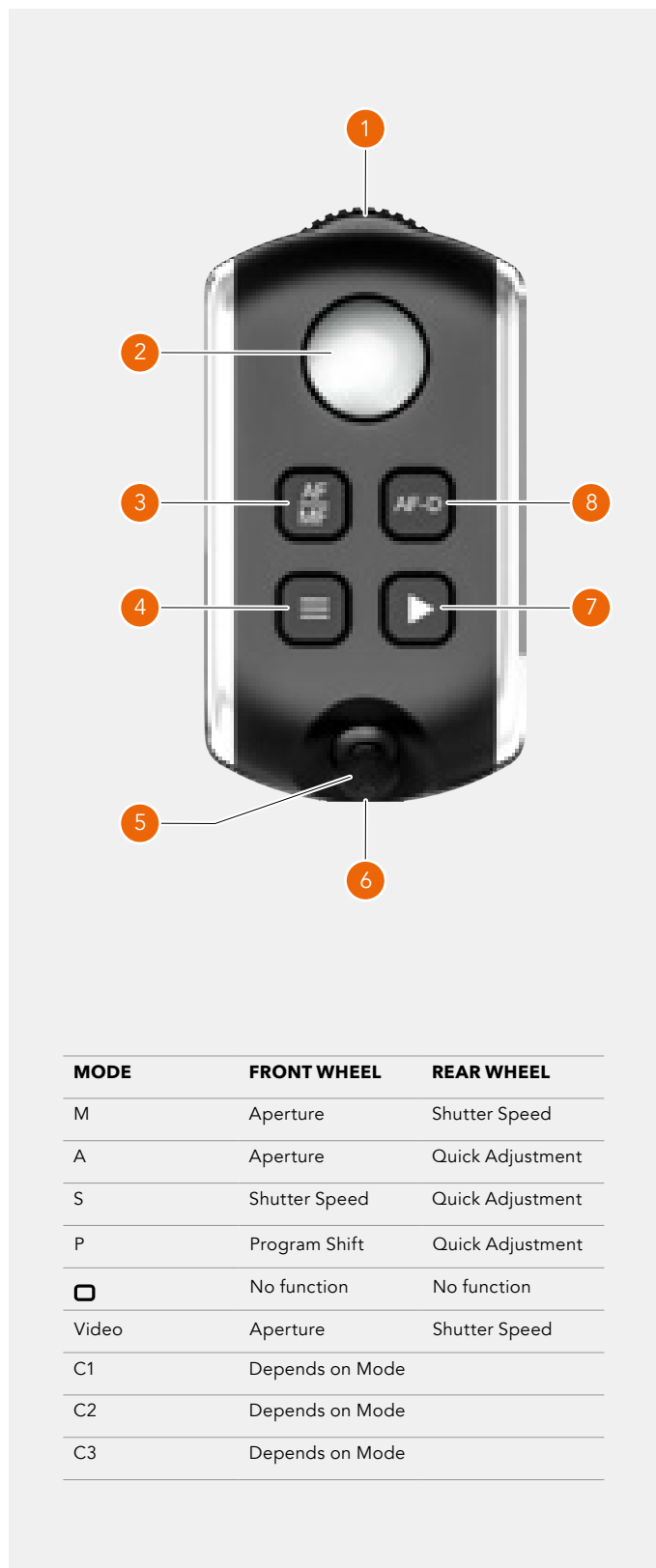

| MODE | FRONT WHEEL | REAR WHEEL |
|-------|-----------------|------------------|
| M | Aperture | Shutter Speed |
| A | Aperture | Quick Adjustment |
| S | Shutter Speed | Quick Adjustment |
| P | Program Shift | Quick Adjustment |
| □ | No function | No function |
| Video | Aperture | Shutter Speed |
| C1 | Depends on Mode | |
| C2 | Depends on Mode | |
| C3 | Depends on Mode | |

Note!

With the camera in a low position it may be easiest to use the thumb for the all buttons.

JOYSTICK

The joystick can be moved in 4 directions as shown in the illustration. It also can be clicked on as a button. Depending on camera mode, different things will happen.

Live View mode

In AF mode, moving the joystick will move the AF area to a new position. In MF mode, nothing will happen. Pressing the joystick will zoom in to 50% or 100% depending on setting as described on page 122.

9 Menu mode

By moving the joystick up or down, different menu items are selected. Click the joystick to enter the selected item.

10 Control screen

Moving the joystick in any direction will select one of the items that can be changed. Click the joystick to enter the setting for selected item.

Browse mode

Moving the joystick sideways will change preview image. Up or down movement will cycle through the available overlays. Pressing the joystick will zoom in steps until 100% is reached. When in 100% zoom-in, pressing the joystick will zoom out again.



Menu navigation

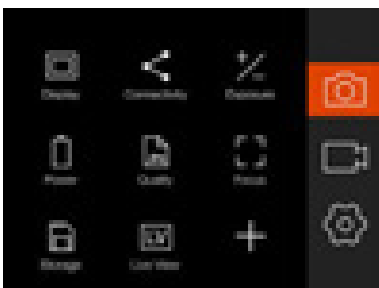

Move the joystick to select Camera settings and click to enter.

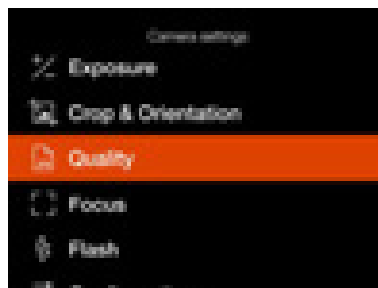

Move the joystick down to highlight Quality. Move the joystick to the right to enter.

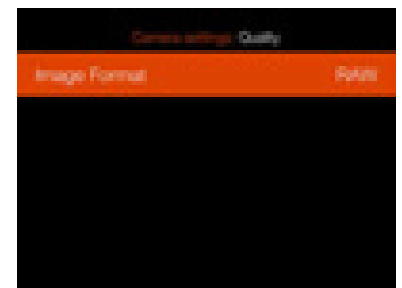

Move the joystick right to enter the setting.



Move the joystick up/down and click to select a new setting.

Control screen setting



Move the joystick to highlight ISO.



Click the joystick and move it up or down to select a new value.



Press the joystick to accept the new value.

Move AF area

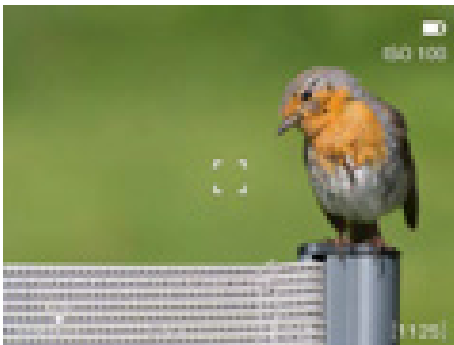

AF area is centered.

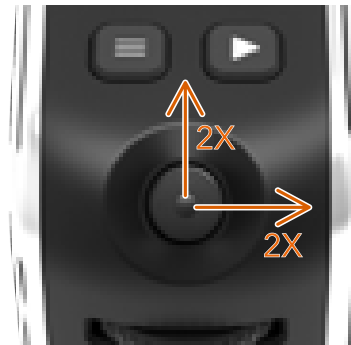

Move the joystick two times to the right and two times up to move the AF area in this example.

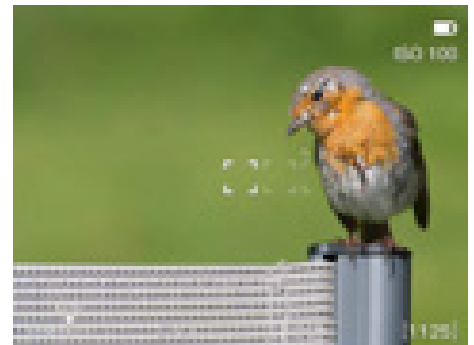

Browse images



Sideways movement changes preview image.



Up or down movement changes overlay.



8.1 907X OPTICAL VIEWFINDER

The optical viewfinder (OVF) for the 907X camera, is available as an optional accessory. It provides eye-level shooting and has markings for the XCD 21, XCD 30 and XCD 45 lenses.

ATTACHING TO THE CAMERA

- Before first use you must mount the OVF to the bracket as shown below **(A)**. Push the OVF in until it locks. To remove, press the buttons **(1)** and **(2)** and slide off the OVF.
- Remove the top plate **(3)** by sliding it backwards.
- Insert the OVF bracket **(4)** and make sure it is fully inserted.
- Attach the CFV to secure the OVF.



OVF MARKINGS

When looking through the OVF, you can see three frames indicating the coverage for the following lenses:

- XCD 21 **(1)**
- XCD 30 **(2)**
- XCD 45 and XCD 45P **(3)**

There is also a plus marking **(4)** to indicate the image center.

Note!

The markings indicate coverage at infinite or long distances. For close-up and precise work, you should always use live view on the display.

Note!

Avoid attaching a flash unit with electrical contacts to the OVF bracket as there is a risk of short circuit that can damage the flash.

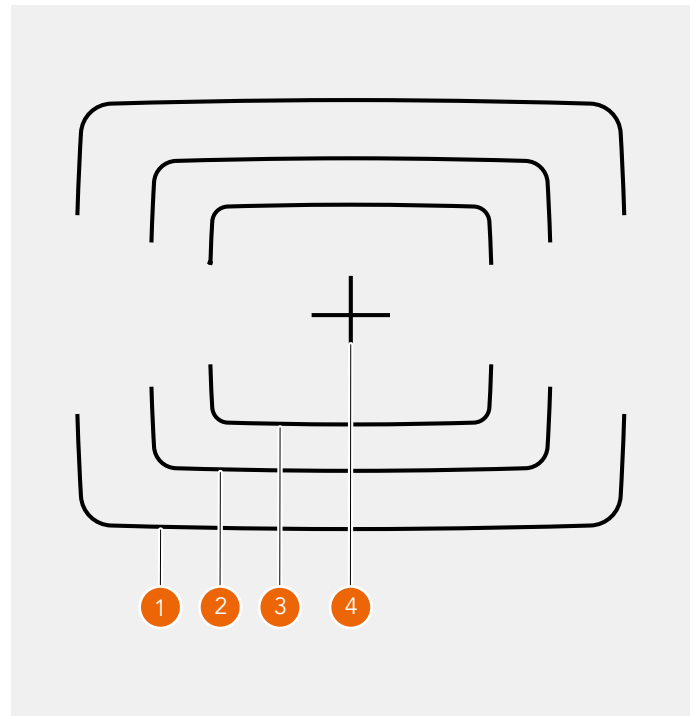

9.1 PHOCUS OVERVIEW

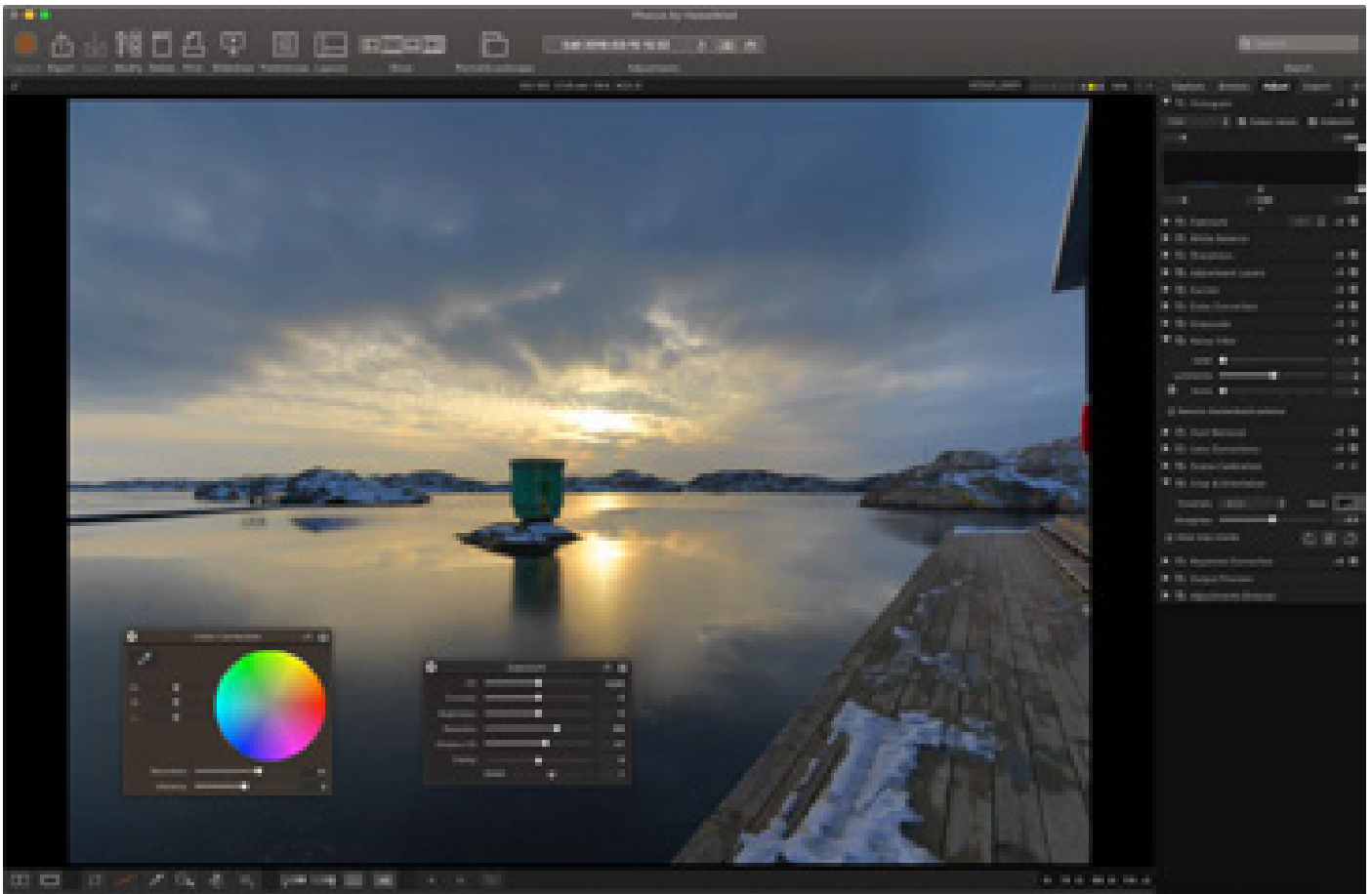

PHOCUS

Phocus is a professional image processing and file management application aimed primarily at Hasselblad RAW 3F file handling. Phocus is available license-free for both Mac and Windows.

The image processing engine in Phocus is optimized for Hasselblad RAW files. Ensuring the maximum quality from your images. Colours and image details are rendered with highest possible accuracy.

FEATURES IN PHOCUS

Phocus is feature-filled while still being easy to use, making it easy to achieve amazing results. Some of the powerful tools and features are:

Natural Colours

Hasselblad's Natural Colour Solution (HNCS) enables you to produce outstanding and reliable colours so that skin tones, specific product colours, and difficult gradations reproduce beautifully every time without the need for multiple colour profiles.

Keystone perspective correction

The Keystone tool enables you to perform high quality perspective corrections directly in Phocus. This can be done both via a simple guideline interface or manual slider adjustments. Additionally, the dual-axis correction capability is extremely useful when copying flat artwork.

Local adjustments

A number of powerful adjustment tools can be used for local adjustments of the image, allowing for quick and precise corrections.

Digital lens correction

Hasselblad's modern lens design has been optimised for digital perfection, including full automatic correction of colour aberration, distortion and light fall off. Phocus makes use of

its detailed knowledge of the lens design and calculates the optical corrections for every shot at the given distance and aperture setting, providing perfect images, and an ideal basis for optimal image rendering and further processing. Hasselblad digital lens correction technology works automatically with all Hasselblad H and X System lenses, even with tilt/shift movements and with all Carl Zeiss lenses from the classic V System, using manual settings.

Auto moiré detection

Phocus can now scan your images and automatically detect moiré interference patterns. You can choose to correct the interference globally or locally via the local adjustment tool.

Live view functionality - Camera control

In tethered situations, Phocus allows for complete camera remote control, including exposure settings, focusing and mirror control. The ability to have live view greatly simplifies tasks such as composing and focusing.

Note!

Read the dedicated user guide for Phocus which can be downloaded from www.hasselblad.com.

Note!

Phocus is a license free software with unlimited installations and there is no registration needed.

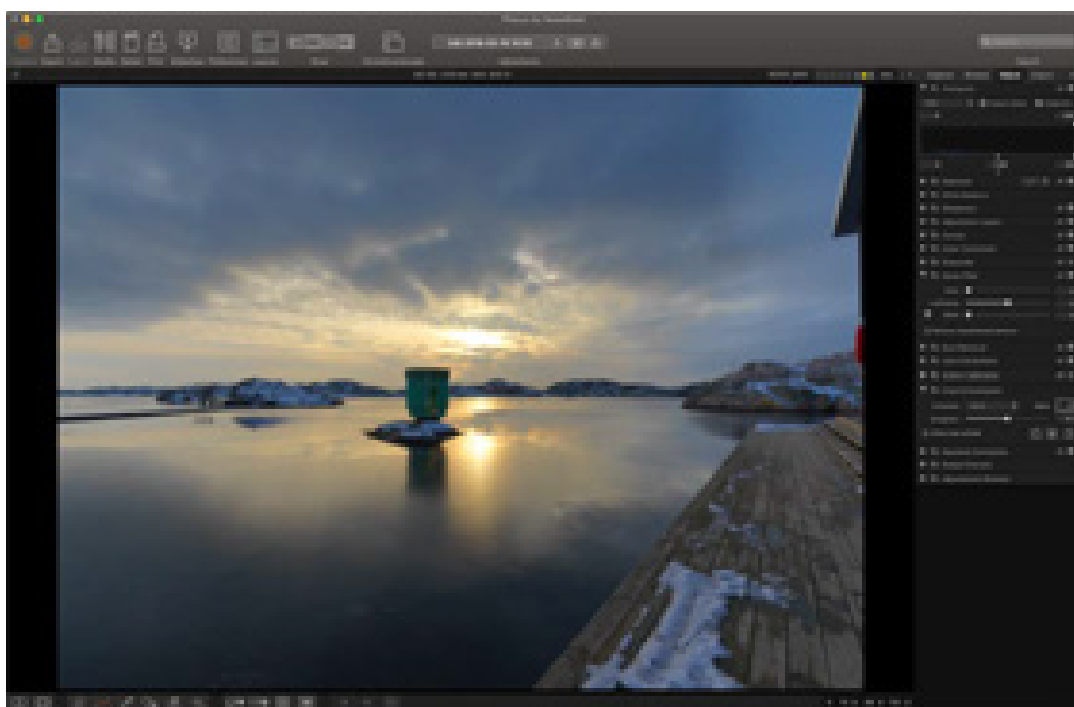

PHOCUS MOBILE 2

Phocus Mobile 2 is the successor to the original Phocus Mobile iOS application adding a number of new features. Most importantly it adds support for both USB and Wi-Fi connectivity, will let you capture images directly to the iOS device and provides full quality image editing and export. It will support both iPhone and iPad but for the image editing functionality an iPad Pro or one of the most recent iPad Air models with more than 2GB RAM is required. It will support the 907X/CFV II 50C as well as the X1D II 50C cameras and future models - the original Phocus Mobile will still be needed for the older cameras.

Note!

The 907X/CFV II 50C and X1D II 50C cameras are not compatible with the original Phocus Mobile app.

For further details please refer to the dedicated Phocus User Guide and [hasselblad.com/phocusmobile2](https://www.hasselblad.com/phocusmobile2).

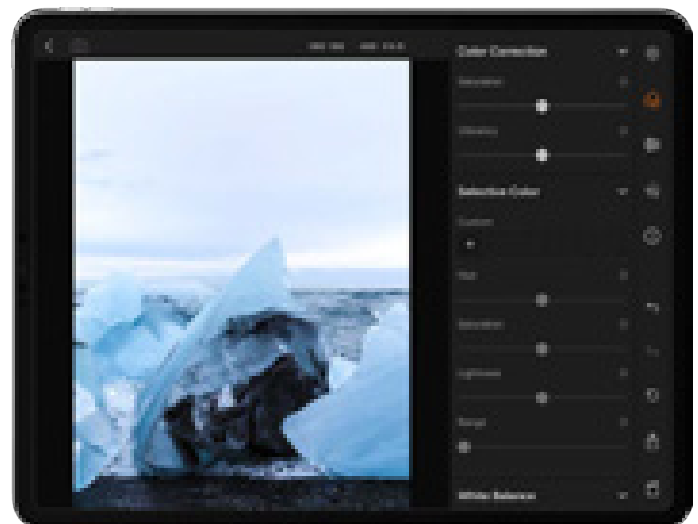
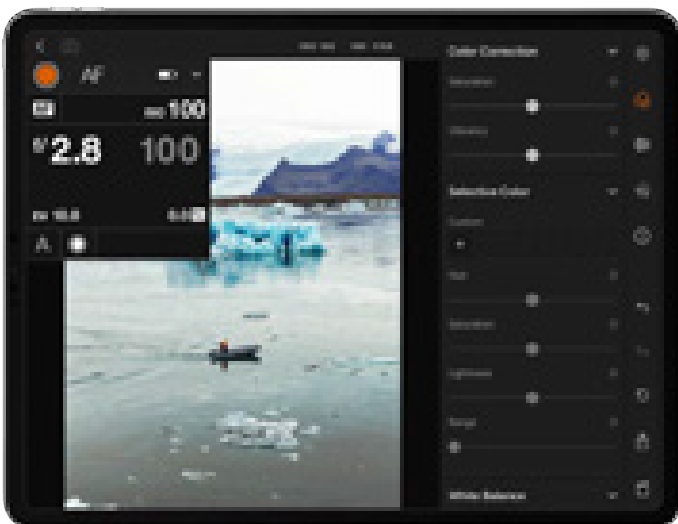
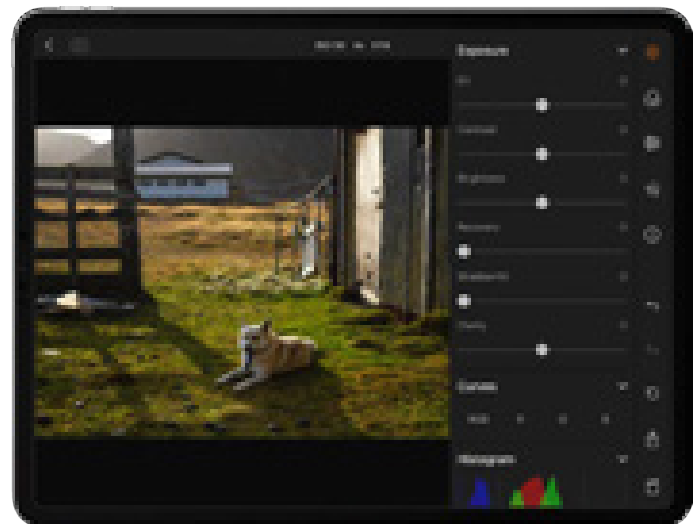
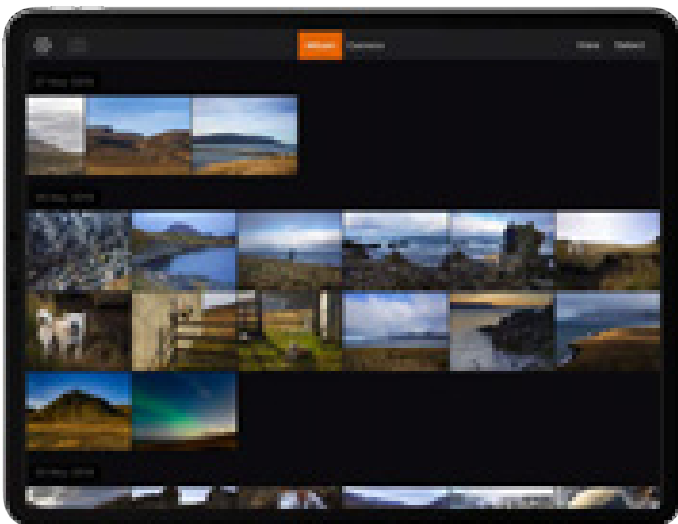

9.2 CONNECT TO A COMPUTER

- 1 Connect a USB 3 cable to the USB port on the computer.
- 2 Connect the USB 3 cable to the USB port on the camera.

When initiating a shot from Phocus, the computer sends a signal to the camera, which triggers the shutter (and strobe/flash, if any). The camera then sends the capture over the USB connection to the computer, where it is displayed on the computer screen and saved as a 16-bit 3F file in the currently selected folder on the computer hard disk.

Note!

When connected to a computer, the following applies:

- The destination medium and location are controlled from Phocus.
- All exposure settings, including ISO, aperture and exposure time, are controlled from Phocus if you choose to expose from Phocus. In addition extra tools such as live video, remote focus control are available. See Phocus user manual for full description.

Note!

Make sure the Tethering mode is set to Mac/PC when connecting to a computer. See more on page 121.

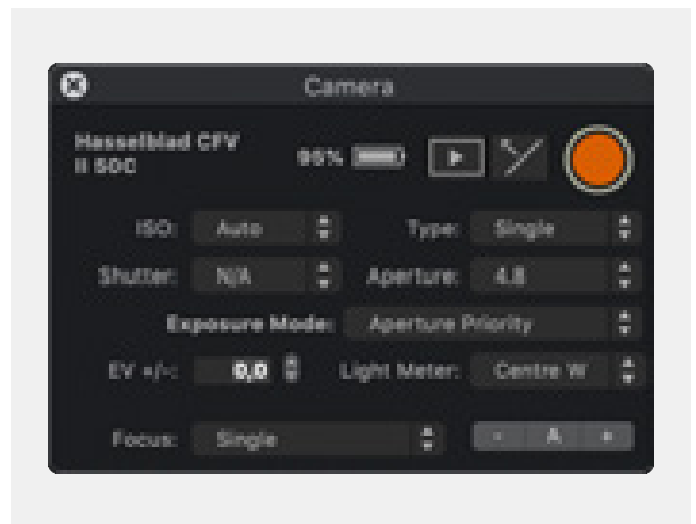

9.3 CONNECT TO AN IPAD PRO

USING CABLE

Tethered shooting via a USB cable, is available with an iPad Pro running Phocus Mobile 2 when using Wi-Fi and cable connections. A cable connection can be made through the USB-C port or when using a Lightning to USB 3 adapter. A USB-C to Lightning cable will also work, but will only give USB 2 speed.

Connect a USB-C to C cable from the camera to the iPad and start the Phocus Mobile 2 App. See more on the next page.

Note!

Make sure the Tethering mode is set to iOS when connecting to an iPad using USB. See more on page 121.

When the camera is connected via Wi-Fi to the iPad Pro, both tethered capture and camera control are supported.

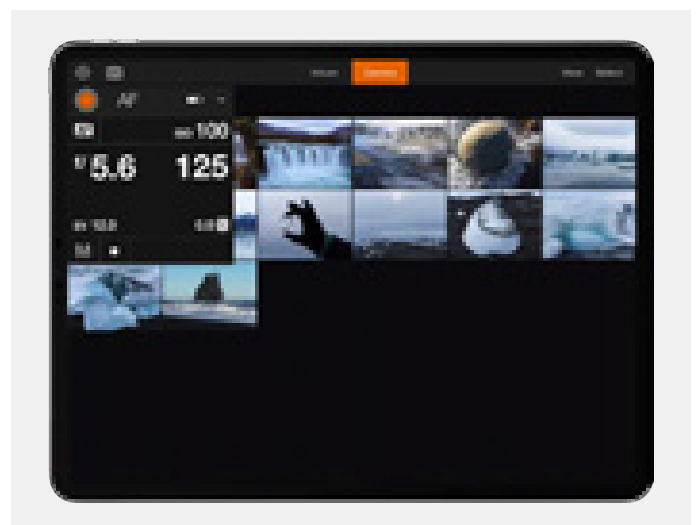

USING WI-FI

Connect the iPad using the procedure described on page 129.

9.4 CONNECT THE CAMERA TO AN IPAD PRO OVER WI-FI

The following assumes that Phocus Mobile 2 is installed on a compatible iPad (iPad Pro or iPad Air 2019). It is available as a free download from the Apple App Store.

Two methods are available to connect the iPad to the camera.

BLUETOOTH ASSISTED WI-FI CONNECTION

- 1 Make sure that Bluetooth is activated on the iPad.
- 2 Start Phocus Mobile 2 on the iPad.
- 3 Start the camera and activate Wi-Fi **(A)**.
- 4 In Mobile 2, go to the Camera Tab **(B)**.
- 5 Mobile 2 starts to search for cameras. When finished, a list of available cameras will be shown **(C)**.
- 6 Select your camera from the list.
- 7 If this is the first time the camera is connected to this iPad, the camera will show the dialogue **(D)** to confirm the connection. Press the Rectangle Button (□) to confirm the connection. If you want to deny the connection request, press the Cross Button (×).
- 8 The iPad will show the dialogue **(E)**.
- 9 If you confirm the connection request, the camera will automatically send the Wi-Fi password (shown in the Connectivity menu) to the iPad. To confirm this connection, you will have to tap Join in the dialogue **(F)** that appears on the iPad.
- 10 When the connection is established, the Camera Icon in the upper left corner of the App window will change from grey to white **(G)**.

Note!

This process is simplified when a camera has been previously connected to this iPad. Then only steps **(A)**, **(B)** and **(F)** are required.

Also see “Connectivity settings” on page 129.

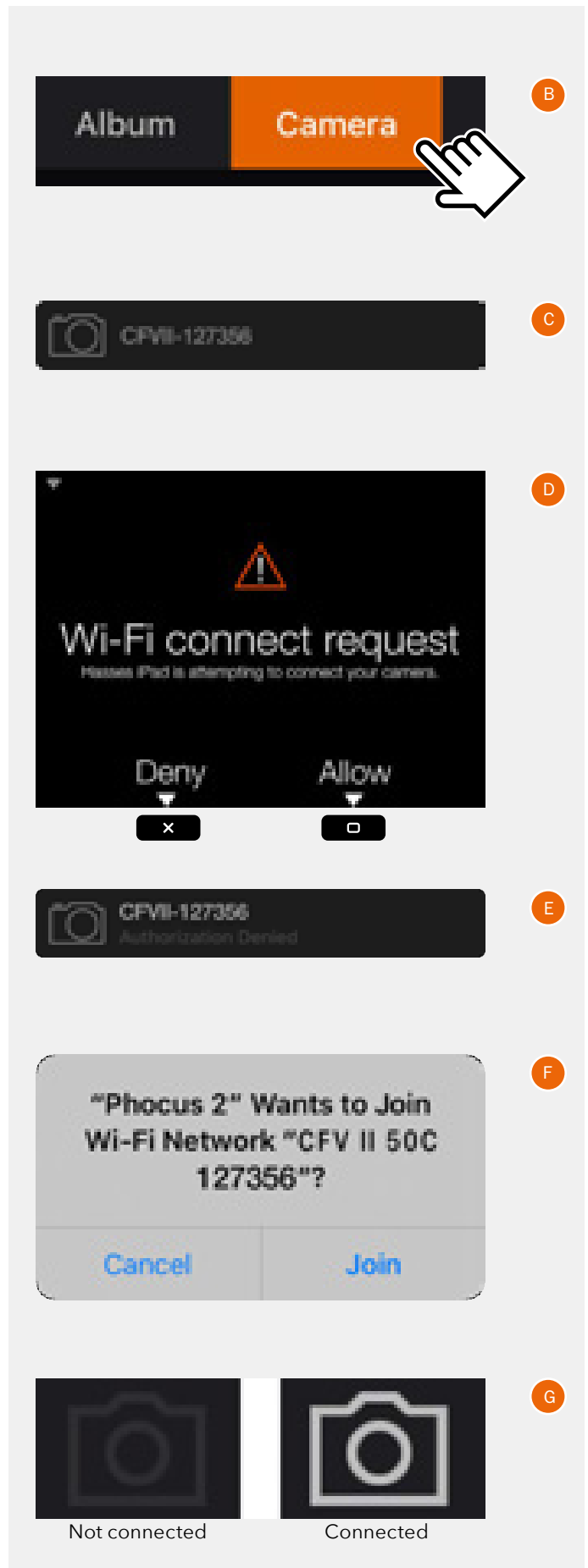
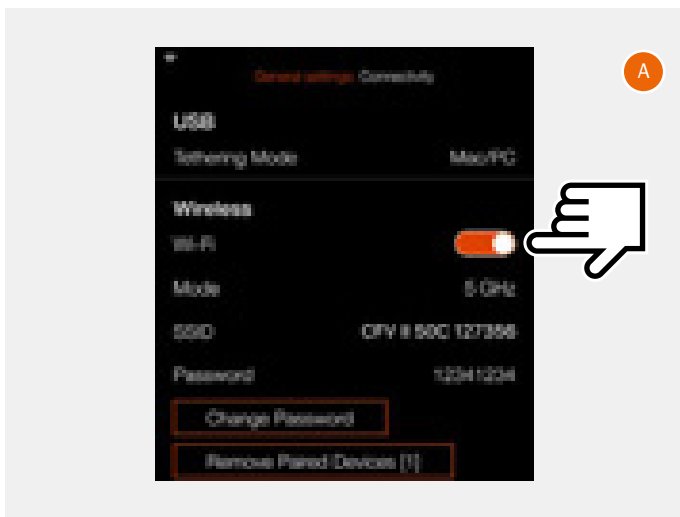

MANUAL WI-FI CONNECTION

- 1 Start the camera and activate Wi-Fi **(A)**. The camera will now create a Wi-Fi network with the same name as the SSID **(1)**.
- 2 Enter the settings on the iPad by tapping the Settings Icon. 
- 3 In the iPad settings dialogue, tap "Wi-Fi" **(B)**.
- 4 In the list "My Networks" or "Other Networks" you will find the camera network. Tap on it to connect **(C)**.
- 5 If the camera has not previously been connected to this iPad, a password dialogue will appear on the iPad **(D)**.
- 6 Enter the camera password **(2)**.
- 7 When the camera network is shown directly under Wi-Fi **(E)** a connection is established.
- 8 Start Phocus Mobile 2 on the iPad.

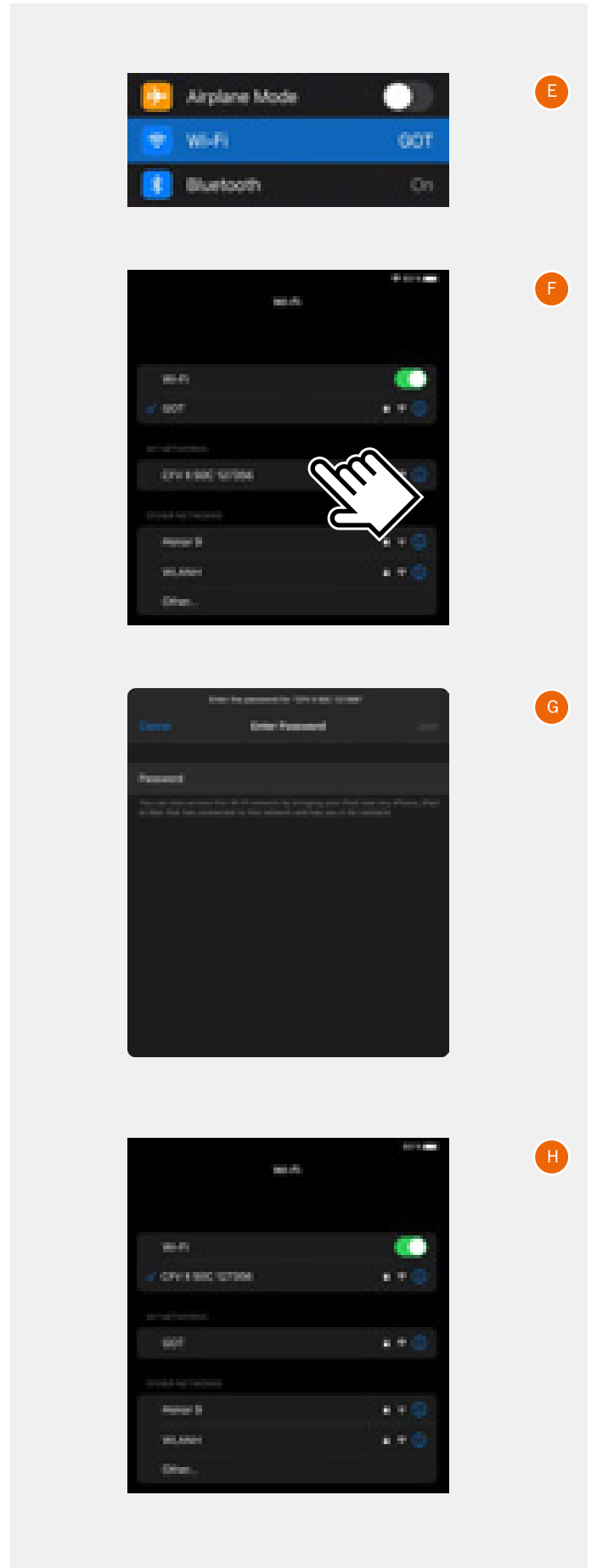
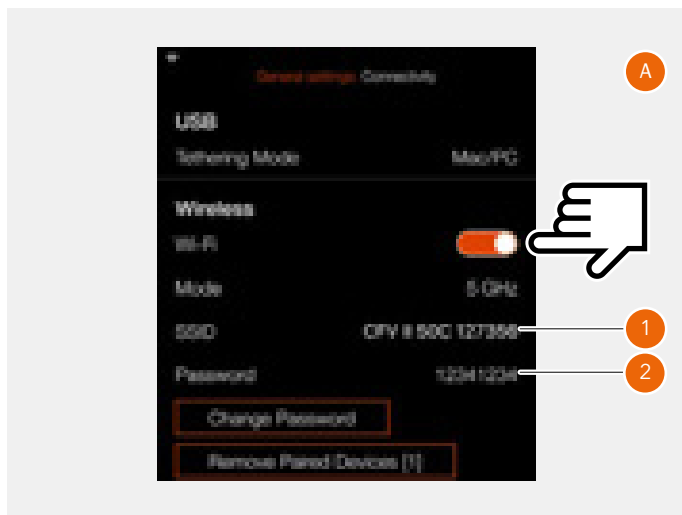

9.5 PHOCUS AND HASSELBLAD CAPTURE FILES

Images captured by the camera are stored as Hasselblad RAW format files or JPEG format. It is possible to store either RAW or JPG or both RAW and JPG simultaneously.

Hasselblad RAW files are initially stored in the 3FR format which is a proprietary Hasselblad format for the temporary storage of captures. A 3FR file contains the complete digitized raw image exactly as it was captured by the camera. 3FR information requires further computing power (typically by way of Phocus) to obtain complete development. If developed in Phocus, 3FR files become Hasselblad 3F files - denoted by each file now bearing the suffix ".fff". If developed by other RAW processors, the 3FR files are not converted to 3F but can be exported directly to TIFF and PSD according to requirements.

When working tethered to Phocus or Phocus Mobile 2, 3FR files are automatically processed and stored in the background on a computer appearing as 3F files on the hard disk ready for selective adjustment and export. 3FR files stored on a SD card can be processed using:

- Hasselblad Phocus
- Adobe Camera Raw
- Adobe Lightroom

Capture files can be stored for future use as 3FR files (from a SD card) for later processing in Phocus or other software, or they can be stored as 3F files (as a result of tethered shooting or 3FR files processed and converted in Phocus). In all cases if you keep the original 3FR/3F files, you will also retain the possibility of reprocessing them in the future in later versions of Phocus or other software to take advantage of eventual improvements and developments.



10.1 THE CAMERA SETTINGS MENU

EXPOSURE

Main menu

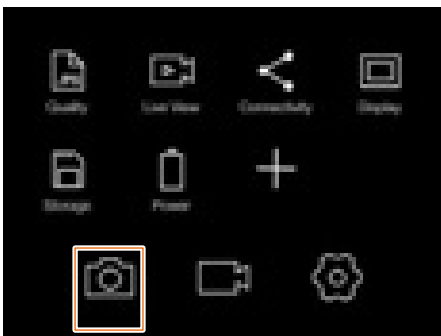

Camera settings menu

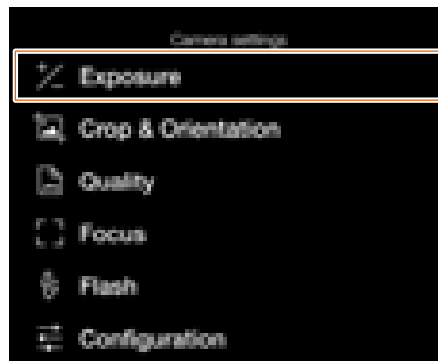

Exposure settings menu

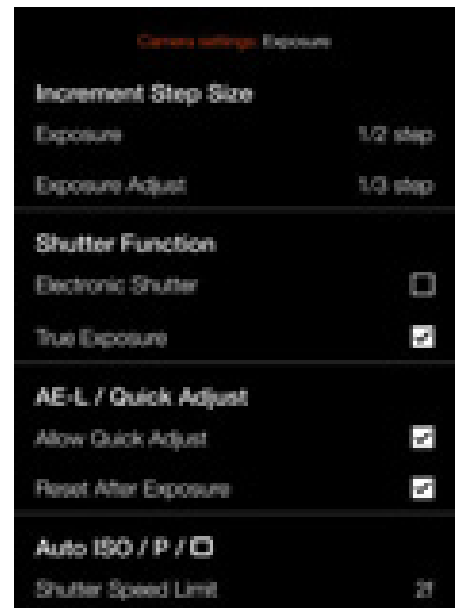

MAIN MENU > CAMERA SETTINGS > EXPOSURE

- 1 Press the camera icon on the touch display.
- 2 The Camera Settings menu appears.

Swipe right or press the menu button to get back to the main menu.

Exposure settings are explained on the next page.

INCREMENT SETTINGS

MAIN MENU > CAMERA SETTINGS > EXPOSURE > INCREMENT STEP SIZE

- 1 Press the camera icon on the touch display.
- 2 The Camera Settings menu appears.
- 3 Press the Exposure settings menu.

Swipe right or press the menu button to get back to the main menu.

Exposure Settings:

Select resolution for exposure settings.

Select between:

- Whole step (1)**
- Half step (1/2)**
- Third step (1/3)**

Exposure Adjust Settings:

Select resolution for exposure adjustment settings.

Select between:

- Whole step (1)**
- Half step (1/2)**
- Third step (1/3)**

Exposure settings menu



Exposure setting



Exposure setting

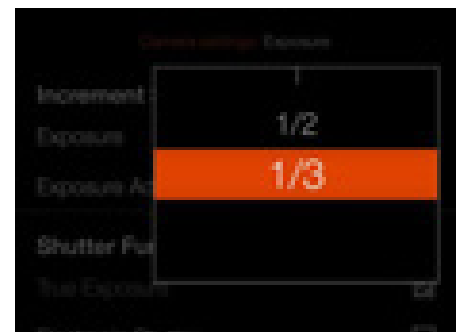

SHUTTER FUNCTION SETTINGS

MAIN MENU > CAMERA SETTINGS > EXPOSURE > SHUTTER FUNCTION

- 1 Press the camera icon on the Touch Display.
- 2 The Camera Settings menu appears.
- 3 Press the Exposure Settings menu.
- 4 Select Shutter Function.

Swipe right or press the menu button to get back to the main menu.

Electronic Shutter

Select **On** or **Off**. If this option is checked, the camera will disable the lens shutter and use an electronic shutter in the sensor instead. When electronic shutter is active, this is indicated with an E symbol in front of the shutter speed in live view and on control screen.

Please note the following limitations with electronic shutter:

- The camera will use the rolling shutter available on the sensor which has a read-out time of approximately 300 ms. This will cause distortion of the image if the camera or subject is moving during the exposure. A tripod and a stationary subject are recommended.
- ISO will be limited to 3200.
- Full image quality is not guaranteed.
- Shutter speed range is 68 minutes to 1/10000 sec.
- Flash is disabled.
- Continuous drive is disabled.
- True Exposure is disabled.

True Exposure

Select **On** or **Off**. The check box will be marked with a when On and the check box is empty when True Exposure is Off.

Determines whether the exposure is automatically adjusted to create a true exposure setting. On allows the adjustment. Off retains the normal setting.

Note!

If using flash/strobe as the main light source and 1/800s or shorter shutter speed (depending on lens type), remember to turn off the True Exposure option.

Note!

The True Exposure feature is designed to keep the effective shutter speed unaffected by aperture setting. See next page.

Exposure settings menu



Control screen with active electronic shutter



Live view with active electronic shutter

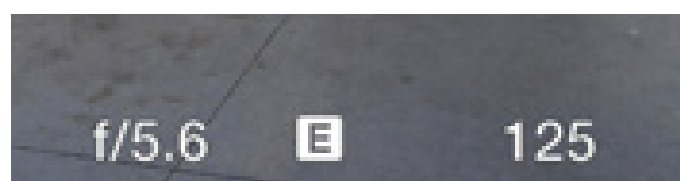

Note!

An active electronic shutter is indicated on the control screen and in live view with an "E" next to the shutter speed.

TRUE EXPOSURE EXPLAINED

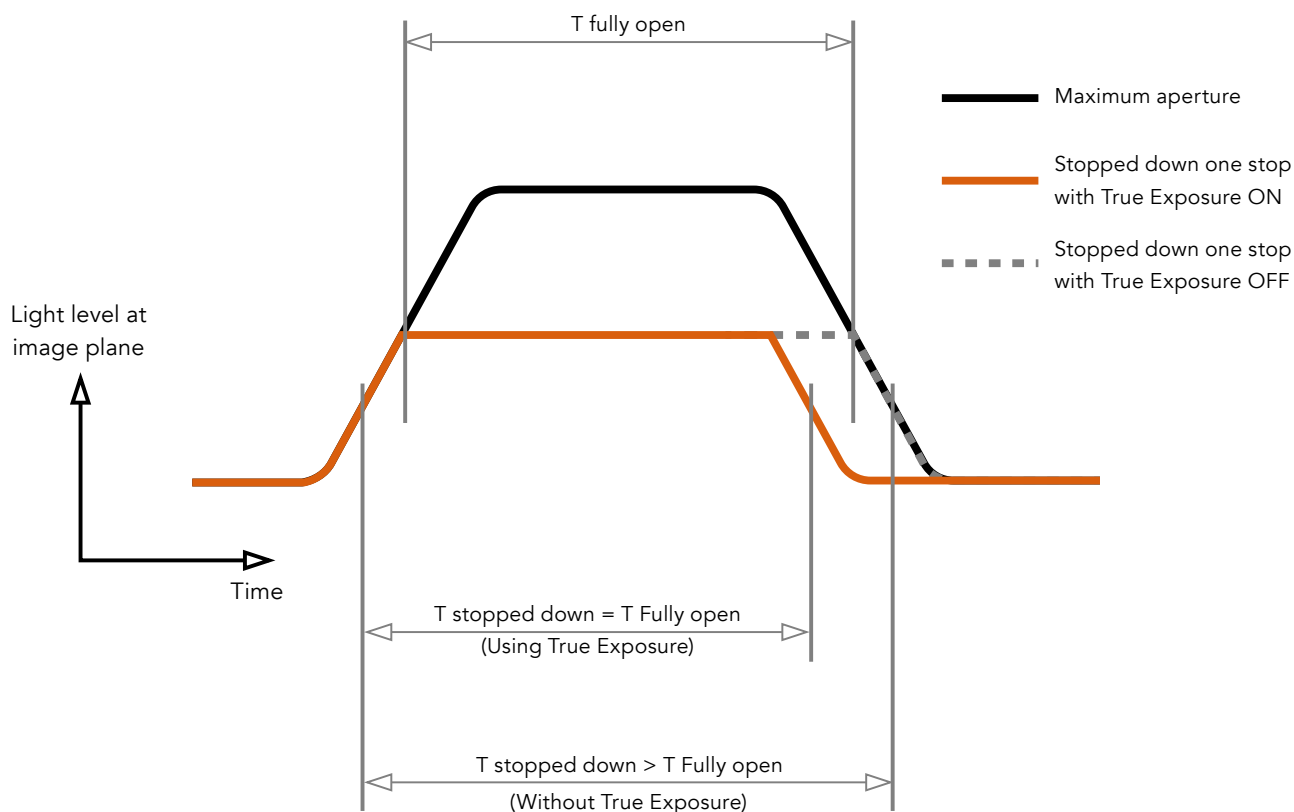

True Exposure is an XCD and HC/HCD lens function that allows the effective shutter speed to remain unaffected when stopping down. This effect is perhaps not so commonly understood as it is restricted specifically to integral lens shutters as opposed to focal plane shutters.

When a lens is stopped down, the effective shutter speed becomes longer, consequently affecting the set exposure. At slow shutter speeds the effect is minimal but at faster speeds, e.g. 1/500s, the effect becomes clearly visible. Automatic compensatory measures in speed setting adjustments are employed.

As compensation can only be put into effect where speeds can be adjusted, this prevents the possibility of adjusting the fastest speed. To counter this, compensatory adjustments are therefore made to the aperture instead to retain the set expo-

sure. This compensation is not always required and when using flash/strobe as the main light source it is actually undesirable because compensation will result in underexposure. Therefore, when using flash/strobe as the main light source, you should set True Exposure to OFF in **Main Menu > Camera Settings > Exposure > True Exposure** in the Camera Display.

You can download a complete explanation of this situation at www.hasselblad.com.

AE-L (AE-LOCK) / QUICK ADJUST

MAIN MENU > CAMERA SETTINGS > EXPOSURE > AE-L / QUICK ADJUST

- 1 Press the camera icon on the touch display.
- 2 The Camera Settings menu appears.
- 3 Press the Exposure settings menu.
- 4 Scroll down to AE-L / Quick adjust.

Swipe right or press the menu button to get back to the main menu.

Allow Quick Adjust

Select **On** or **Off**. The check box will be marked with a ✓ when On and the check box will be empty when Off.

When the box is checked you can use the rear control wheel to input a quick exposure adjustment.

Reset After Exposure

Select **On** or **Off**. Controls if a quick exposure adjustment and AE-Lock state is reset by an exposure or not.

Exposure settings menu

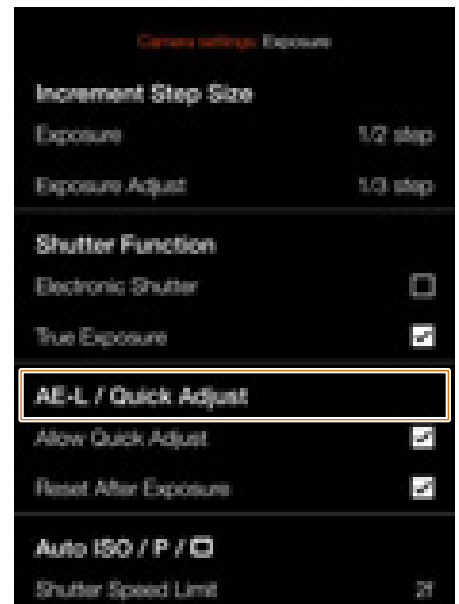

AUTO ISO / P / FULL AUTO

MAIN MENU > CAMERA SETTINGS > EXPOSURE > AUTO ISO/P/FULL AUTO

- 1 Press the camera icon on the touch display.
- 2 The Camera Settings menu appears.
- 3 Press the Exposure settings Menu.
- 4 Scroll down to Auto ISO/P/Full Auto

Swipe right or press the menu button to get back to the main menu.

Shutter Speed Limit

The shutter speed limit can be set either directly or as a function of focal length. See illustrations to the right.

Auto ISO: Sets the slowest shutter speed before ISO will be increased.

P: If the calculated shutter speed is slower than the set value, the aperture value will be changed instead of Shutter Speed.

Full Auto: If the calculated shutter speed is slower than the set value, the aperture value will be changed instead of shutter speed.

Note!

The shutter speed Limit can still be exceeded in some cases. For instance if using A mode and the maximum ISO limit is already reached and there is not enough light, the shutter speed limit will be exceed as a last resort to get a proper exposure.

Exposure settings menu



Direct shutter speed limit setting

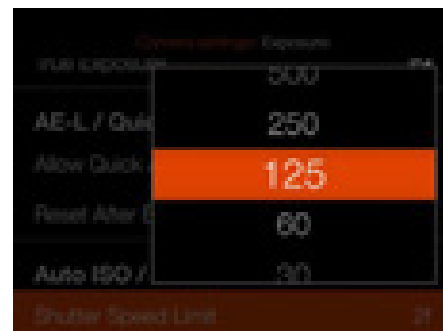

Shutter speed limit is set to: 1/125 s.

Shutter speed limit setting as a function of focal length.

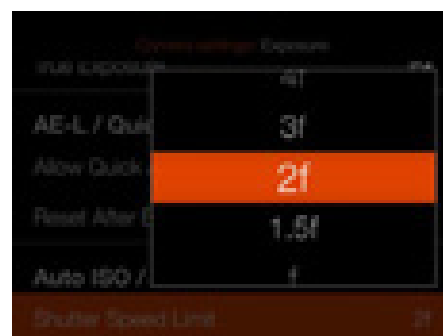

With this setting and a 45mm lens, the Shutter Speed Limit will be: $1/(2 \times 45) = 1/90$ s.

CROP & ORIENTATION

MAIN MENU > CAMERA SETTINGS > CROP & ORIENTATION

- 1 Press the camera icon on the touch display.
- 2 The Camera Settings menu appears.
- 3 Press the Crop & Orientation menu.

Swipe right or press the menu button to get back to the main menu.

Crop Mask

Adds a crop mask to live view and the RAW file. When imported to Phocus, the crop mask can be modified or removed.

Crop Mode Settings:

- No Crop (645)
- 1:1 (6x6)
- 7:6 (6x7)
- 5:4 (4x5)
- 11:8,5 (Letter)
- 297:210 (A4)
- 3:2 (6x9)
- 3:2 Crop (24x36). See note below.
- 16:9 (Screen)
- 2:1 (6x12)
- 65:24 (XPan)

Notes:

- JPG files are not cropped.
- Crop Modes are disabled in USB tethered mode.
- Crop Modes are not supported in Phocus Mobile 2.

Continued on the next page.

Camera settings menu



Crop & Orientation settings menu



Live view with **No Crop**

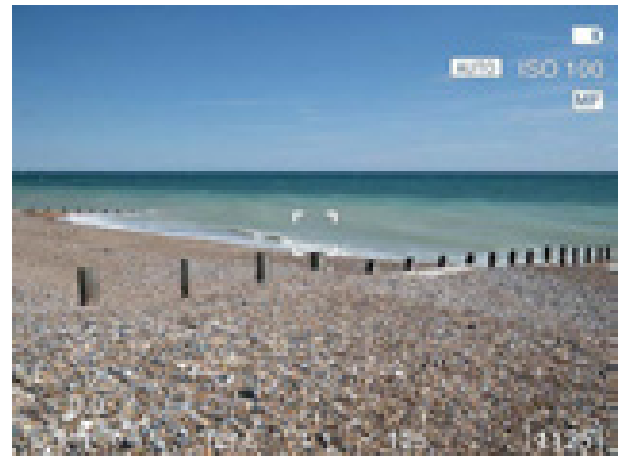

Live view with **65x24 (XPan)**

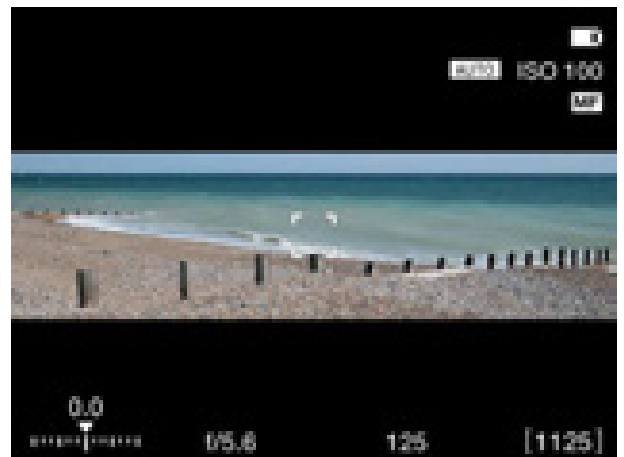

IMAGE ORIENTATION

MAIN MENU > CAMERA SETTINGS > CROP & ORIENTATION

- 1 Press the camera icon on the Touch display.
- 2 The Camera Settings menu appears.
- 3 Press the Crop & Orientation menu.

Swipe right or press the menu button to get back to the main menu.

Image Orientation in Post

Sets the viewing orientation of captures when they appear in Phocus. To avoid unintentional orientation changes when the camera is pointing straight up or down, the orientation setting can be locked.

Clockwise Rotation Settings:

Select between:

Auto.

Lock at 0 degrees.

Lock at 90 degrees.

Lock at 180 degrees.

Lock at 270 degrees.

Camera settings menu



Crop & Orientation settings menu



Orientation settings

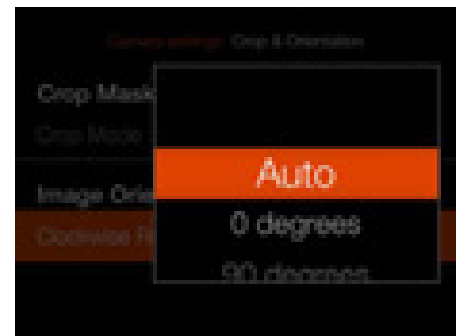

IMAGE QUALITY SETTINGS

MAIN MENU > CAMERA SETTINGS > QUALITY

- 1 Select the camera icon on the touch display.
- 2 The Camera Settings menu appears.
- 3 Press the Quality settings menu.

Swipe right or press the menu button to get back to the main menu.

Image Format settings

Select between:

- RAW.**
- RAW + JPG.**
- JPG.**

Note!

JPG file size depends on subject and ISO value. Subjects with many details or a high ISO setting will give larger files.

Camera settings menu

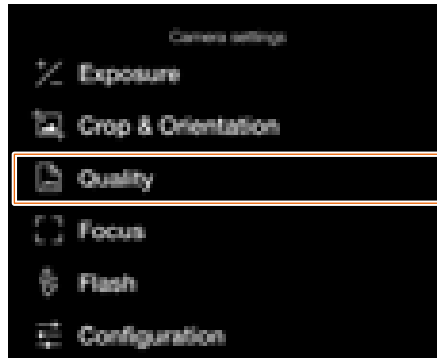

Quality menu

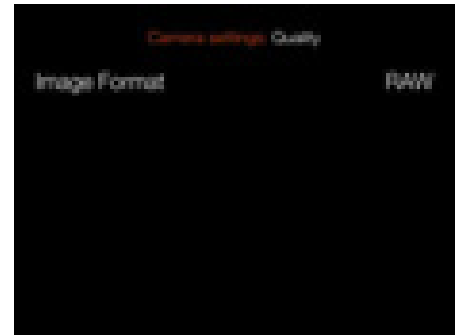

Image Format settings menu



FOCUS SETTINGS

MAIN MENU > CAMERA SETTINGS > FOCUS

- 1 Select the camera icon on the touch display.
- 2 The Camera Settings menu appears.
- 3 Press the Focus settings menu

Swipe right or press the menu button to get back to the main menu.

Autofocus

AF Point Size settings

Select the size of the area used for AF measurements. You can choose between:

- Large** (35 points)
- Medium** (63 points)
- Small** (117 points)

Reset Focus Point settings

Select any of these two settings:

- After Exposure**
- Never.**

Autofocus point can be reset to centre position after every exposure. If you need the autofocus point to remain in the specific position, select Never.

See section page 127 for more in-depth information.

Scan Range Settings

For lenses that support this function (e.g. the XCD 120 Macro or the XCD 135) is used you can choose between:

- Near**
- Far**
- Full**

These settings will limit the focusing scan range to scan in AF mode. If Near or Far is selected, AF speed will be faster.

Continued on the next page.

Camera settings menu



Focus menu

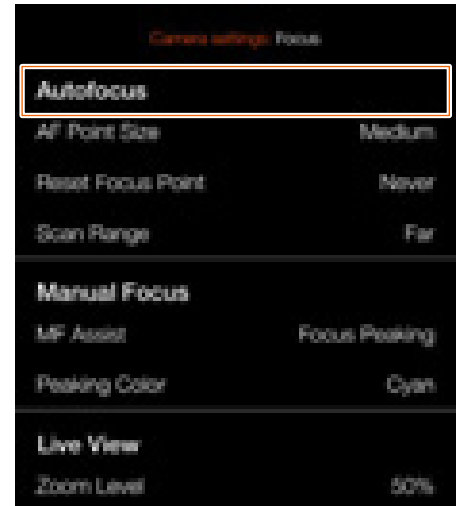

AF point size setting



Reset Focus Point setting

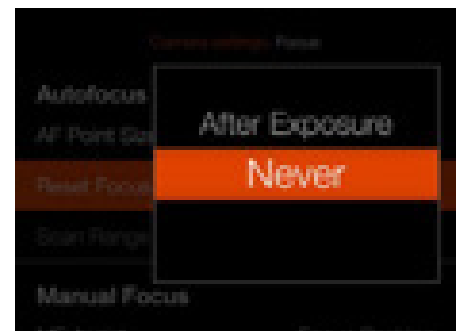

Scan Range setting



A Far-icon **(A)** is shown when Scan Range Far is selected. If Near is selected, the Near-icon **(B)** is shown.

Live View when Far setting is selected

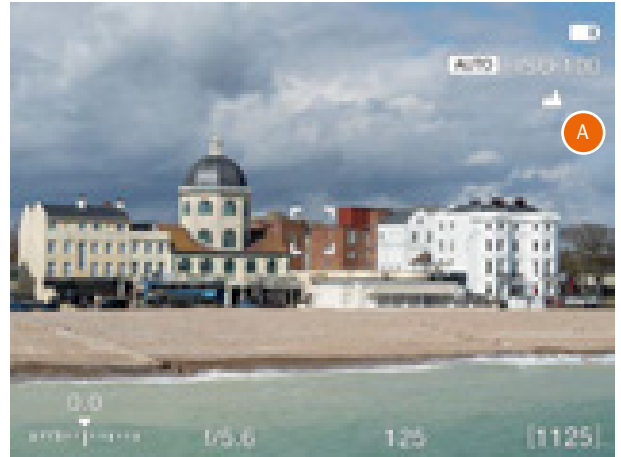

Live View when Near setting is selected

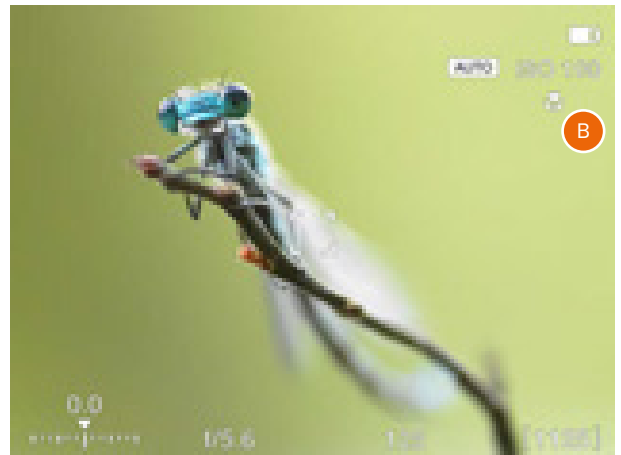

MAIN MENU > CAMERA SETTINGS > FOCUS

- 1 Select the camera icon on the touch display.
- 2 The Camera Settings menu appears.
- 3 Press the Focus settings menu

Swipe right or press the menu button to get back to the main menu.

Manual Focus

MF Assist Settings

Select the manual focus assist mode. Choose between:

Focus Peaking

See page 79.

Auto Zoom

The live view image will zoom in to 50 or 100% when the focusing ring is turned. See page 78.

None

Manual focus assist is turned off.

Peaking Color settings

Select the focus peaking color to be used. You can choose between:

Orange

Yellow

Cyan

Magenta

Live View

Zoom Level

Select **50%** or **100%**.

Controls the zoom level when you double-tap the screen, press the Star Button in live view mode or use the auto zoom function in manual focus.

Camera settings menu

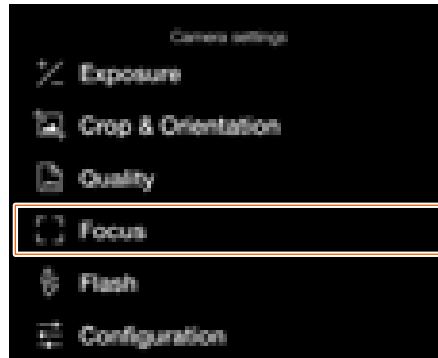

Focus menu

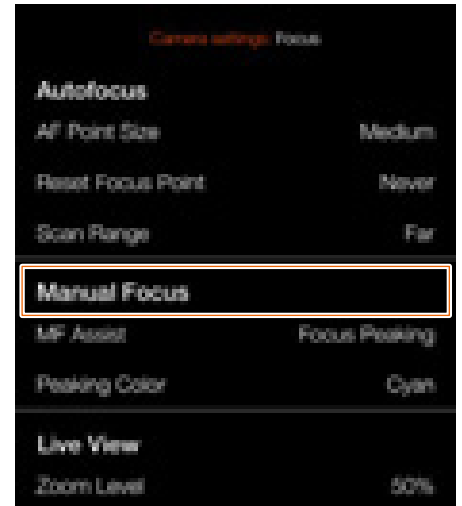

Subject not in focus



MF Assist setting



Subject in focus



Focus Peaking Color setting



Zoom Level Setting



FLASH SETTINGS

MAIN MENU > CAMERA SETTINGS > FLASH

- 1 Select the camera icon on the touch display.
 - 2 The Camera Settings menu appears.
 - 3 Press the Flash settings menu
- Swipe right or press the menu button to get back to the main menu.

Camera settings menu

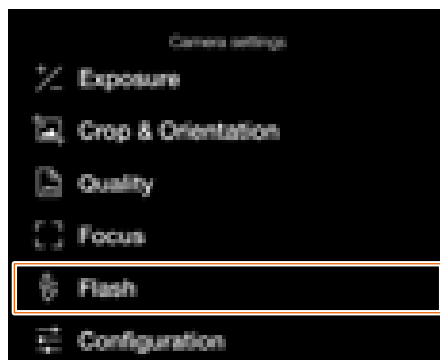

Flash settings menu

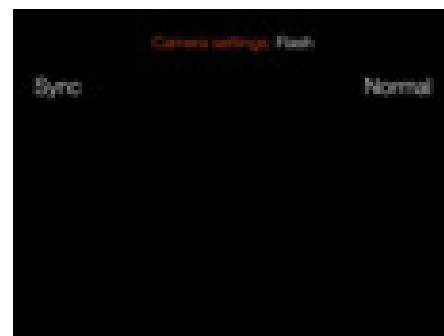

Sync settings

Controls if the flash shall be triggered in the beginning or at the end of the exposure. Select between:

Normal (beginning of the exposure)

Rear (end of the exposure)

Sync settings

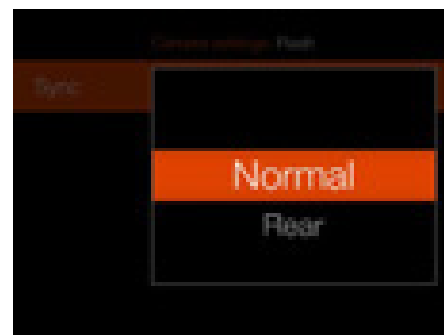

CAMERA CONFIGURATION SETTINGS

MAIN MENU > CAMERA SETTINGS > CONFIGURATION

- 1 Select the camera icon on the Touch display.
- 2 The Camera Settings menu appears.
- 3 Press the Configuration settings menu

Swipe right or press the menu button to get back to the main menu.

Auto ISO Limits

Maximum Settings

Sets the maximum allowed ISO for the Auto ISO function.

Minimum Settings

Sets the minimum allowed ISO for the Auto ISO function.

Lens

Max Aperture Setting

Select if the lens shall use a fully open and round aperture at maximum setting. A round aperture will create a smoother look for the out-of-focus areas. For some lenses, e.g. the XCD 90, this can cause a very slight overexposure.

Normal

Standard setting. Will minimize the risk for internal reflections.

Full

Selects a fully open round aperture. Only for XCD Lenses.

Continued on the next page.

Camera settings menu



Configuration menu

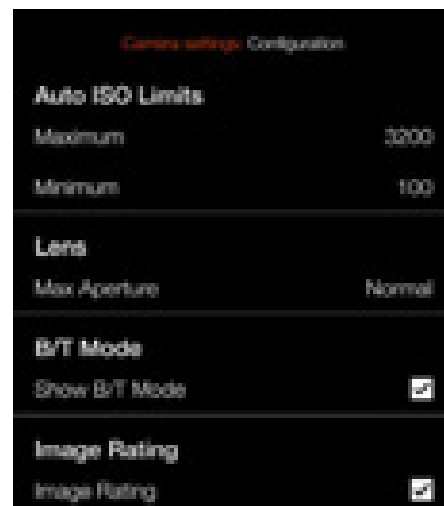

Max aperture setting menu

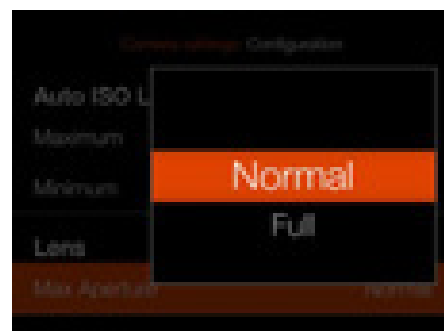

Image detail with **Normal** setting



Image detail with **Full** setting



Normal



Full

B/T Mode

Show B/T Mode setting

B and T mode is available in the list of shutter speeds if the box is checked.

Image rating

Image Rating

If the box is checked, the star button is used for image rating in browse mode. See page 90.

Camera settings menu



Configuration menu

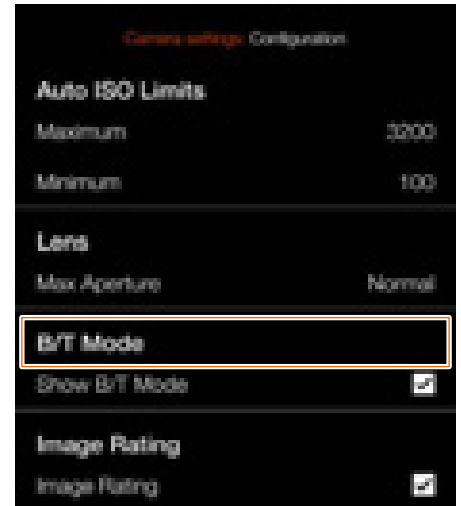

Time Setting B&T available

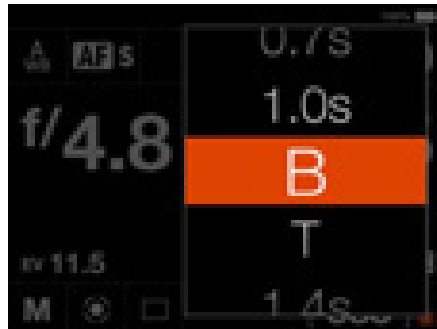

Time Setting B&T not available



10.2 VIDEO SETTINGS MENU

Main menu



Video icon

Video Settings Menu

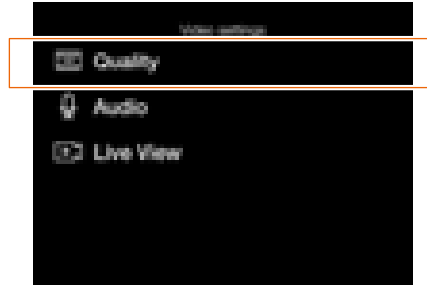

Video Quality Settings



Resolution Setting

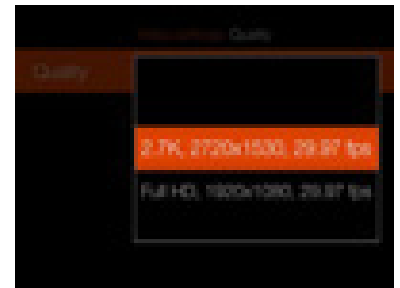

MAIN MENU > VIDEO SETTINGS

- 1 Press the Video icon on the Touch Display.
- 2 The Video Settings Menu appears.
- 3 Select a Video Setting.

Swipe right or press the Menu / EXIT button to get back to the Main Menu.

QUALITY

Resolution

Video Quality Resolution Setting
Select between:

2.7K (2720 x 1530 pixels)

Full HD (1920 x 1080 pixels)

Frame rate is 29.97 fps. See more on page 91.

AUDIO

External. Selects recording level for the external microphone.

Select between:

+12 dB, +6 dB, Normal, -6 dB, -12 dB, -18 dB or Mute.

Video Settings Menu

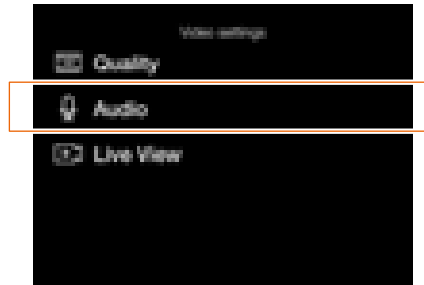

Audio Settings

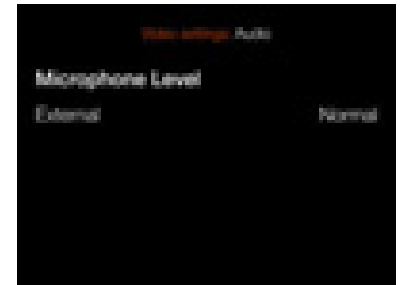

Live View Settings

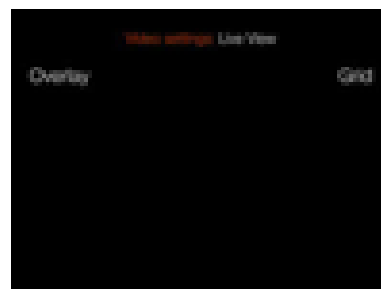

Audio level settings

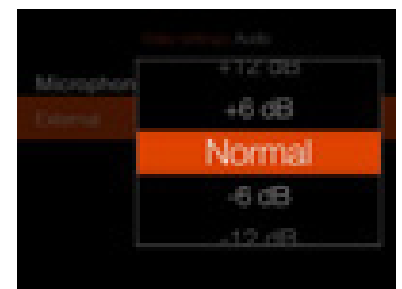

LIVE VIEW

Overlay

Selects the overlay for video Live View screen. Select between:

None.

Grid. Displays a 1/3 grid on the Video Live View screen.

Overlay Setting

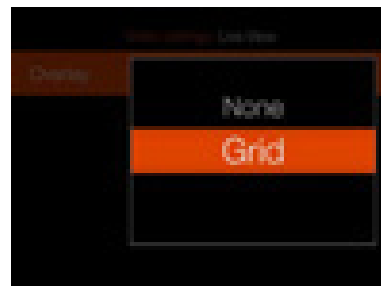

Note!

You can toggle the overlay On or Off by pressing the Rectangle button while in Video Live View.

Note!

Video recording is not possible in tethered mode.

Video Live View screen with grid enabled



10.3 GENERAL SETTINGS MENU

Main Menu

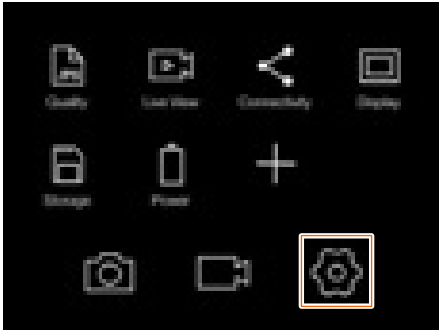

General settings menu

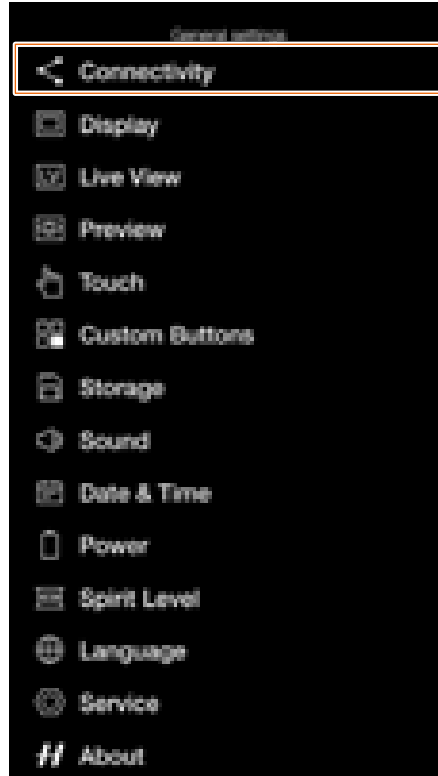

Connectivity settings menu

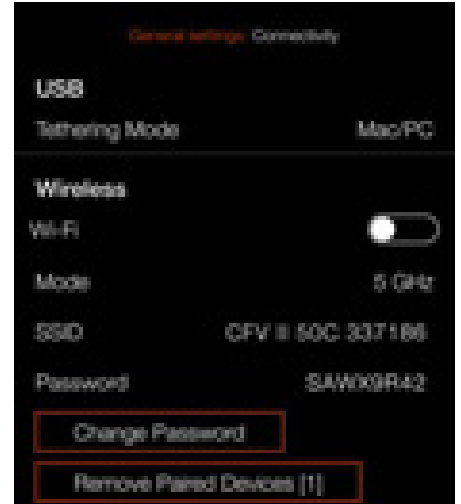

MAIN MENU > GENERAL SETTINGS

- 1 Press the General Settings icon on the touch display.
- 2 The General settings menu appears.

Swipe right or press the menu button to get back to the main menu.

CONNECTIVITY SETTINGS

MAIN MENU > GENERAL SETTINGS > CONNECTIVITY

- 1 Press the General Settings icon on the touch display.
- 2 The General Settings menu appears.
- 3 Press the Connectivity settings menu.

Swipe right or press the menu button to get back to the main menu.

USB Settings

Tethering Mode

Select Mac/PC or iOS.

If the camera is connected via USB to an iOS device, select **iOS**.
For connection to a computer select **Mac/PC**.

Wireless Settings

Wi-Fi

Select **On** or **Off**.

Mode

Select between **2.4** and **5 GHz**.

SSID

The identity of the camera on the Wireless network. See page 107 and page 108 for more info on connection options.

Password

Use this password to connect via Wi-Fi to the camera.

Change Password

Press this button to generate a new password.

Remove Paired Devices

Removes all devices that have been paired over Bluetooth for auto-connection with the Phocus Mobile 2 App. The number within brackets represents the current number of paired devices. If the button is greyed out, no devices have been paired. Press Remove (Rectangle button, □) to confirm or Exit (Cross button, ✕) to return without removing any device.

Note!

The display timeout will temporary be increased to 60 seconds when enabling Wi-Fi. If user touches the screen or press any key during this 60 second timeout the display timeout will be restored to normal value.

Note!

Some regions do not allow 5 GHz Wi-Fi.

Note!

Some regions do not allow Wi-Fi.

Connectivity settings menu

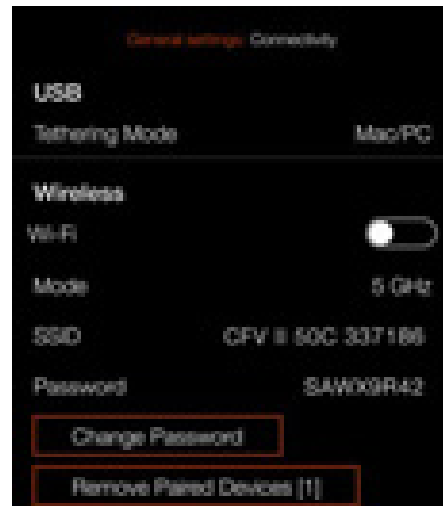

Remove Paired Devices dialogue

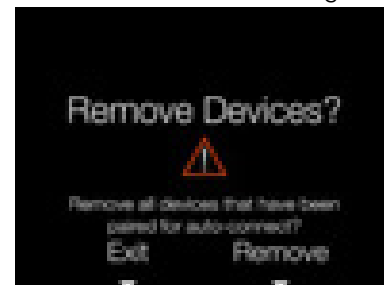

DISPLAY

MAIN MENU > GENERAL SETTINGS > DISPLAY

- 1 Press the General Settings icon on the touch display.
- 2 The General Settings menu appears.
- 3 Press the Display menu.

Swipe right or press the menu button to get back to the main menu.

Brightness

Controls the overall brightness of the rear display. Slide the white dot to the left to make the screen darker and to the right to make it brighter.

Display Off

Select how long the rear display shall be active.

Chose between:

5sec, 10sec, 20sec, 30sec, 1min, 2min, 3min.

Note!

You can force the camera into standby mode to save power by pressing and holding the Menu button and making a short-press on the On/Off button.

General settings menu

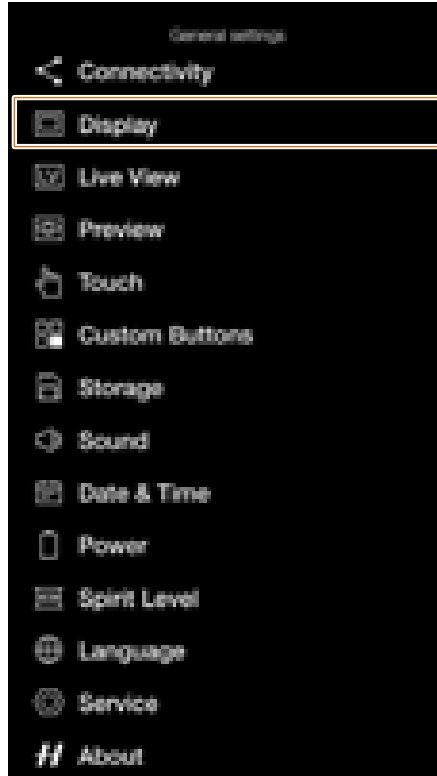

Display settings menu



Display Off setting

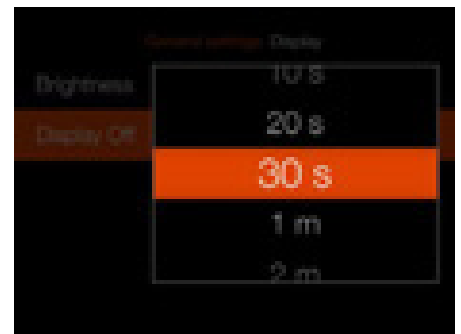

LIVE VIEW

MAIN MENU > GENERAL SETTINGS > LIVE VIEW

- 1 Press the General Settings icon on the touch display.
- 2 The General Settings menu appears.
- 3 Press the Live View menu.

Swipe right or press the menu button to get back to the main menu.

Exposure Simulation

A/S/P/Full Auto

If this box is checked, the display will simulate what the final image will look like. When unchecked, the brightness will not be affected by exposure adjustments.

M

Check this box to use exposure simulation in Manual Mode. The brightness of the screen will reflect the aperture, shutter speed and ISO settings.

General settings menu

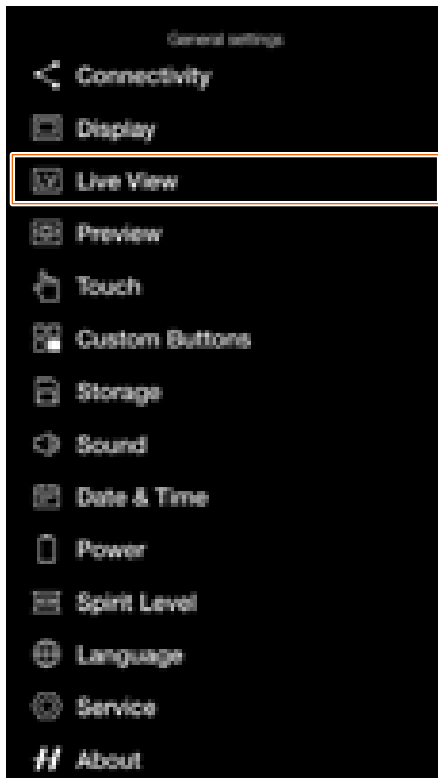

Live View settings menu

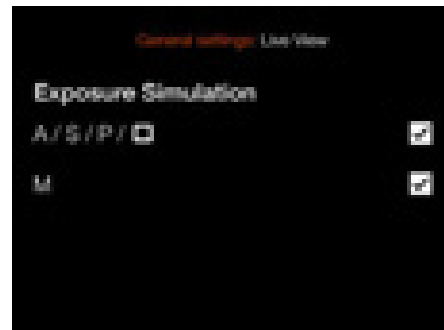

Note!

When you use the camera with a flash, the Exposure Simulation will not display a correct result. For example, if you have set the Aperture and Shutter to be adapted to flashlight indoors, normally the Exposure Simulation displays an image that is too dark in the Live View mode. It is advised to turn off Exposure Simulation before you start to take photos with a flash.

Note!

When Autofocus is active and analysing the subject, the Exposure Simulation is deactivated to let the Autofocus system operate in optimal conditions. When the Autofocus process is ready, the Exposure Simulation is automatically activated again.

Note!

If Exposure Simulation is active and the exposure settings are set to very high overexposure or very low underexposure for the actual light conditions, the Live View displays a very light or very dark image. In extreme cases, it results in a completely overexposed white image or a completely underexposed black image. In these cases you can use the balance scale, down to the left in Live View mode, while adjusting the exposure settings, to maintain desired exposure.

PREVIEW

MAIN MENU > GENERAL SETTINGS > PREVIEW

- 1 Press the General Settings icon on the touch display.
- 2 The General Settings menu appears.
- 3 Press the Preview menu.

Swipe right or press the menu button to get back to the main menu.

Show Preview

Check this box to show a preview on the rear screen after each exposure.

Overexposure Warning

When this box is checked, areas close to overexposure in the preview image will alternate between black and white.

General settings menu

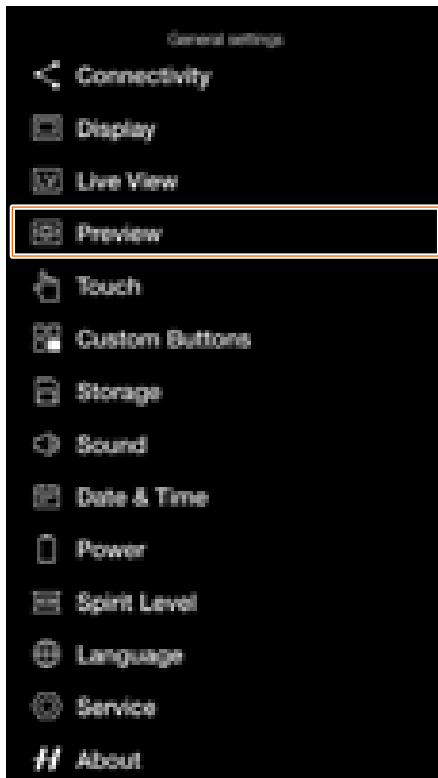

Preview settings menu

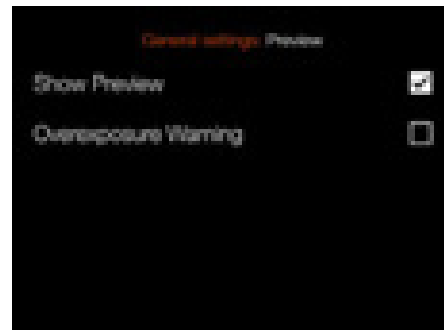

TOUCH

MAIN MENU > GENERAL SETTINGS > TOUCH

- 1 Press the General Settings icon on the touch display.
- 2 The General Settings menu appears.
- 3 Press the Touch menu.

Swipe right or press the menu button to get back to the main menu.

Touchpad for Display

Move AF Point

When checked, the AF point can be moved on the rear display by tapping on the new location.

general settings menu

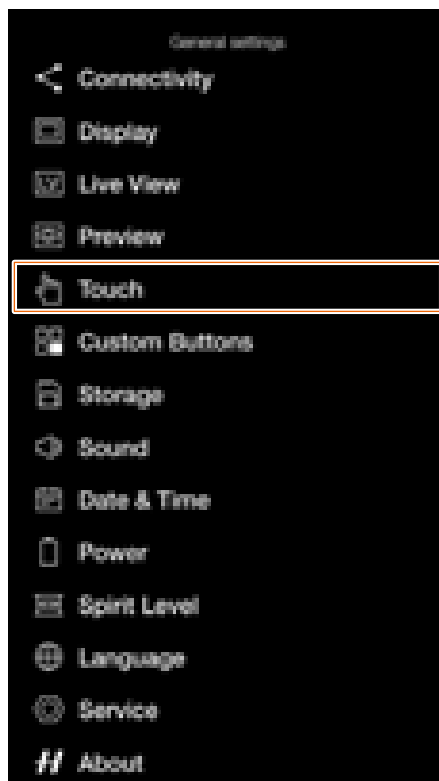

Touch settings menu

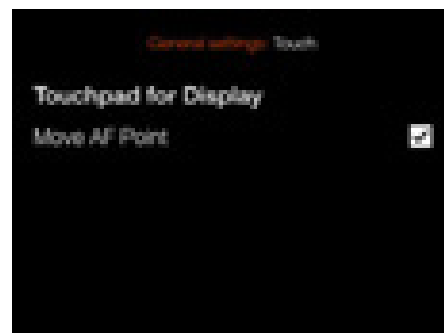

CUSTOM BUTTONS

MAIN MENU > GENERAL SETTINGS > CUSTOM BUTTONS

- 1 Press the General Settings icon on the touch display.
- 2 The General Settings menu appears.
- 3 Press the Touch menu.

Swipe right or press the menu button to get back to the main menu.

Custom Buttons

The Custom Button function allows four of the buttons on the optional Control Grip accessory to be re-programmed to a different function for faster access to frequently used functions.

AF/MF

Settings for the AF/MF button.

AF-D

Settings for the AF-D button.

Menu

Settings for the Menu button.

Browse

Settings for the Browse button.

Scroll through the list and select the required function by tapping.

Reset Custom Buttons

Restore button function to factory default. Pressing this button will bring up a confirm dialogue. Press the Rectangle button to restore the settings to default or the Cross button to exit without changing the settings.

General settings menu

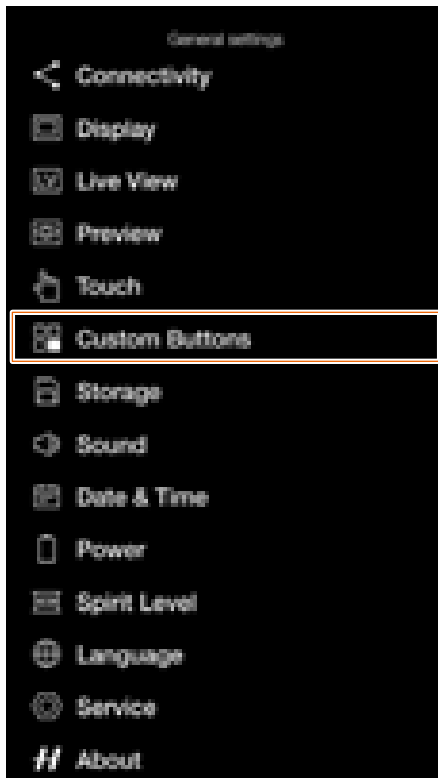

Custom Buttons Settings Menu



AF/MF button settings

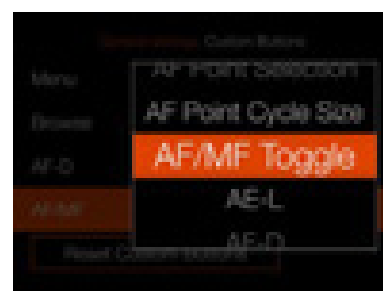

AF-D button settings

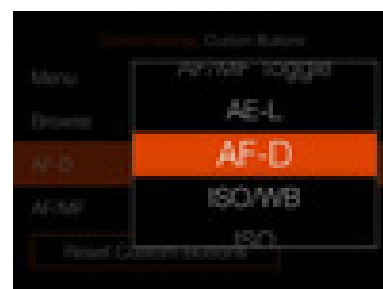

Menu button settings

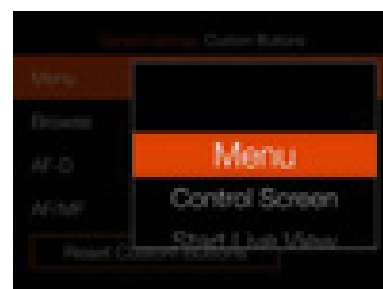

Browse button settings

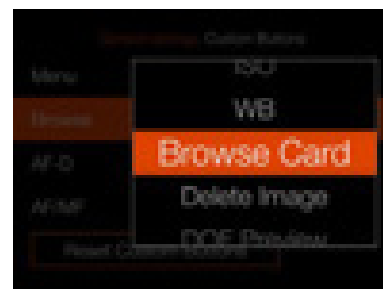

Reset Custom Buttons Confirm

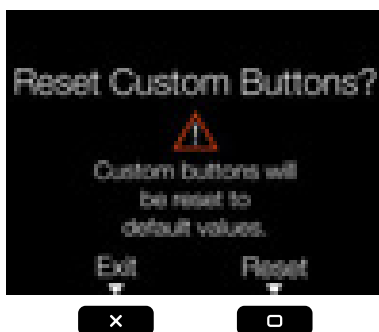

STORAGE

MAIN MENU > GENERAL SETTINGS > STORAGE

- 1 Press the General Settings icon on the touch display.
- 2 The General Settings menu appears.
- 3 Press the Storage menu.

Swipe right or press the menu button to get back to the main menu.

Storage Menu Settings

Format Card

Format SD 1 or Format SD 2.

Image Destination

Select primary slot:

SD 1 or SD 2.

Secondary Slot Usage

Select between:

Overflow or Backup (Images)

If Overflow is selected, the camera will automatically switch to the secondary card when the primary card is full.

If Backup is selected, the camera will save the image to both cards (RAW and RAW + JPG). Video files will not be backed up.

Note!

If Backup is selected and no second card is inserted, the camera will be blocked for exposures. If trying to expose, an information message will be shown. The control screen will show the Backup Missing icon instead of remaining frames.

Speed Check settings

If this box is checked, the camera will check the speed of the card at start-up and show a dialogue if the card is found to be slow.

Speed

After 10 exposures, a speed value will be shown for the active SD Card.

General settings menu

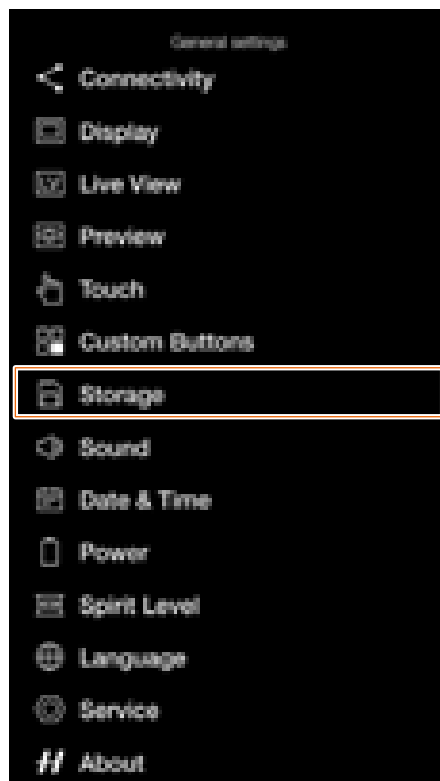

Storage settings menu

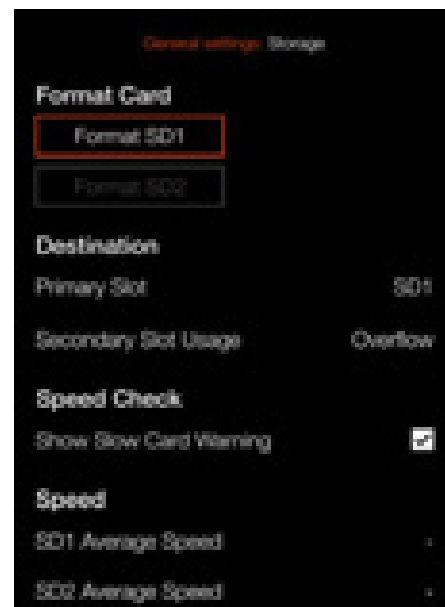

Information message

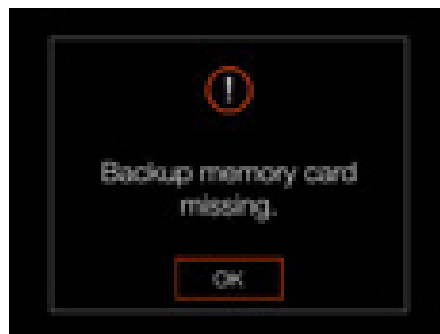
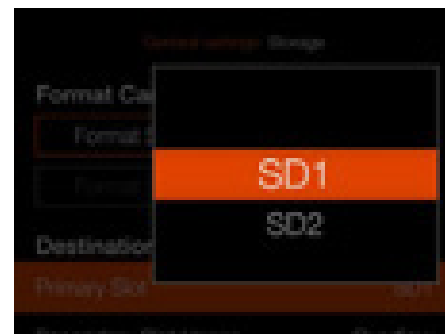

Image Destination dialogue



Control Screen, Backup missing



Secondary Slot usage dialogue

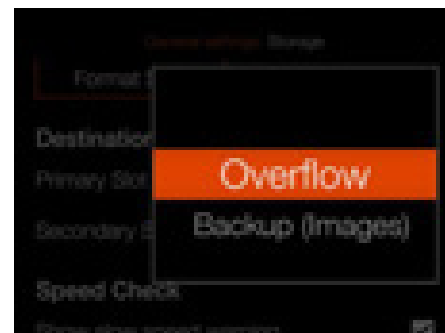

HOW TO FORMAT A MEMORY CARD

- 1 Select card to format, **SD 1** or **SD 2**, on the Storage menu.
- 2 A new Format Card dialogue appears.
- 3 To confirm, select Format by pressing the rectangle button.
- 4 Exit without formatting by pressing the cross button.

General settings menu

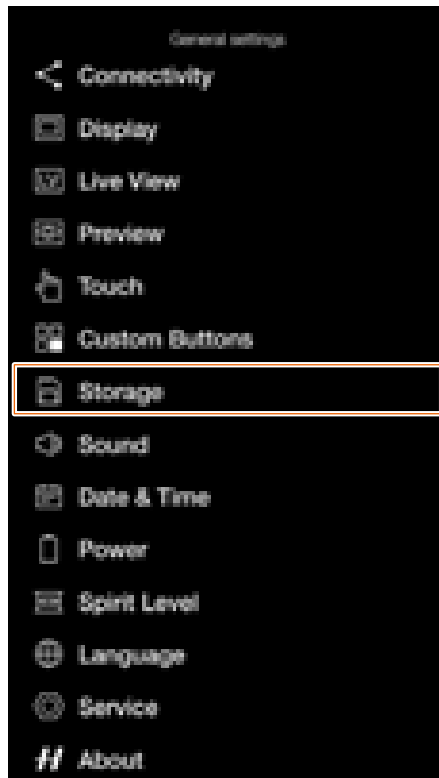

Storage settings menu

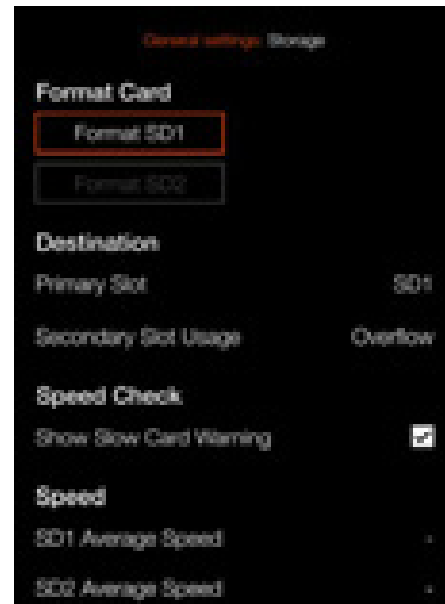

Format SD1 dialogue

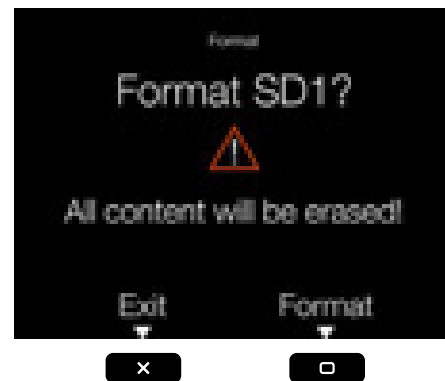

SOUND

MAIN MENU > GENERAL SETTINGS > SOUND

- 1 Press the General Settings icon on the touch display.
- 2 The General Settings menu appears.
- 3 Press the Sound menu.

Swipe right or press the menu button to get back to the main menu.

Volume

Choose between:
Off, Low, Medium, High

AF Result

When this box is checked, a sound will indicate a finished AF setting. If AF is successful or not, the camera will play different sounds.

General settings menu

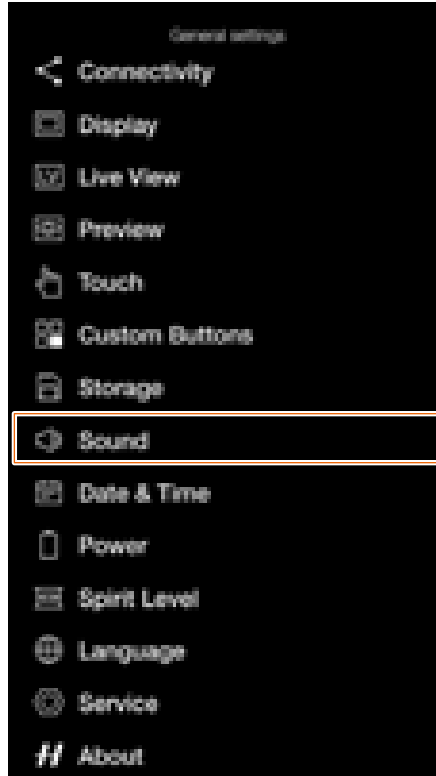

Sound settings menu



Volume settings menu



DATE & TIME

MAIN MENU > GENERAL SETTINGS > DATE & TIME

- 1 Press the General Settings icon on the touch display.
- 2 The General Settings menu appears.
- 3 Press the Date & Time menu.

Swipe right or press the menu button to get back to the main menu.

Date and Time menu settings

Date

Set Date by changing year, month and day using the pop up menus.

Time

Set Time by changing hour and minute using the pop up menus.

General settings menu

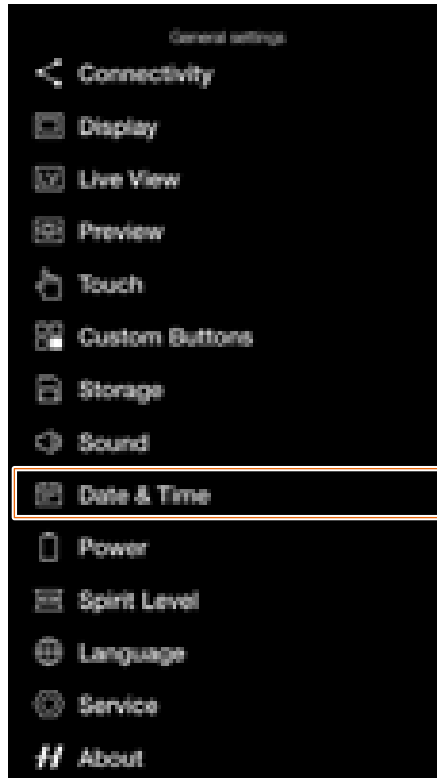

Date & Time settings menu

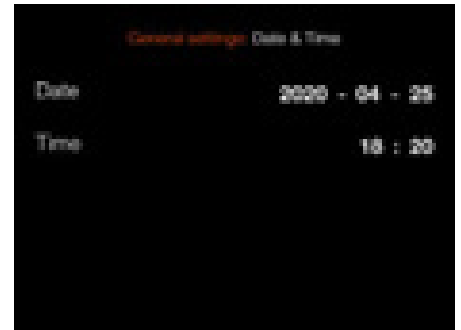

Year setting

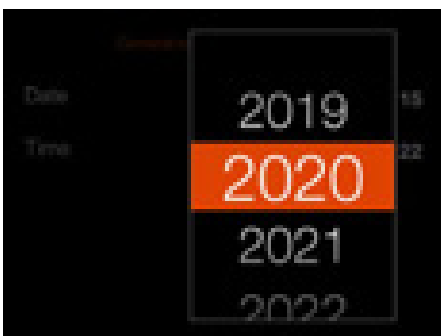

Month setting



Day setting

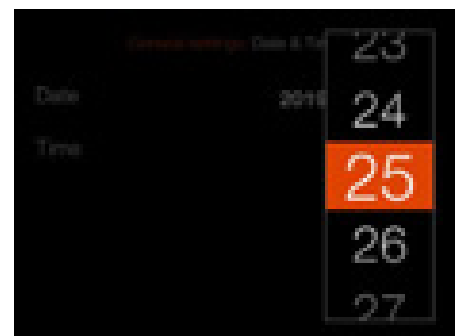

Hour setting



Minute setting

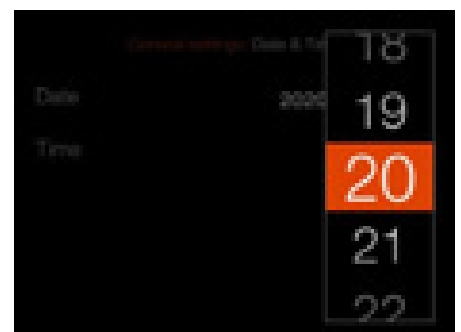

POWER

MAIN MENU > GENERAL SETTINGS > POWER

- 1 Press the General Settings icon on the touch display.
- 2 The General Settings menu appears.
- 3 Press the Power menu.

Swipe right or press the menu button to get back to the main menu.

Power settings

Power Off

Sets the time before the camera automatically turns off.

Choose between:

5 min, 10 min, 30 min, Never.

Power Off when Tethered

Sets the time before the camera automatically turns off when connected to a computer.

Choose between:

5 min, 10 min, 30 min, Never.

Power from Computer USB

When checked, the camera will take power from the USB device. This is indicated by a symbol **(A)** next to the battery on the Control Screen and on the Live View screen.

Control Screen

Show Battery Percentage setting

When the box is checked, an approximate value of the battery charge level in percent is shown next to the battery icon.

Note!

The camera will only be partially powered from USB. A charged camera battery is still required.

Note!

Only power from a USB Host device is supported.

General settings menu

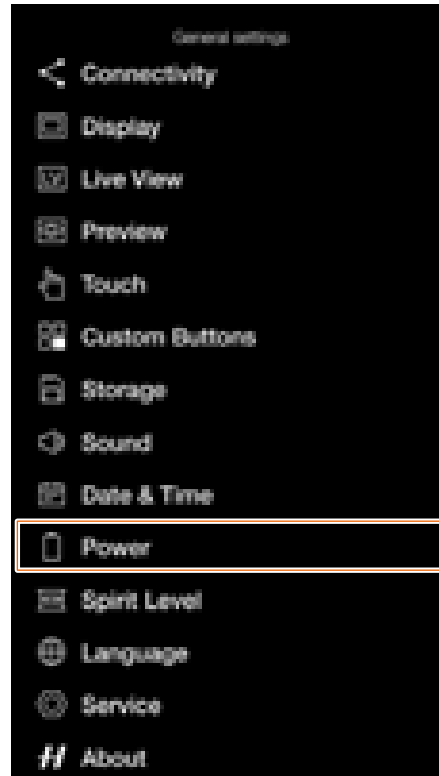

Power settings menu



Indication of active USB power.

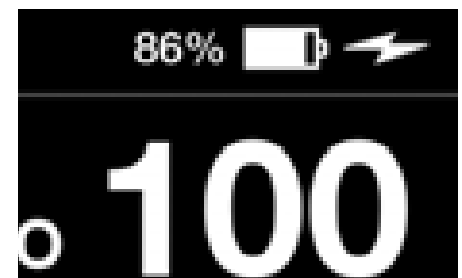

Battery percent value not shown



Battery percent value shown



SPIRIT LEVEL

MAIN MENU > GENERAL SETTINGS > SPIRIT LEVEL

The camera is equipped with an accelerometer. The accelerometer is used to measure the tilt of the camera relative to the horizontal axis (A) and vertical axis (B).

How to align camera with spirit level

- 1 Press the General Settings icon on the touch display.
- 2 The General settings menu appears.
- 3 Press the General Settings Spirit Level icon.
- 4 Adjust the tilt of the camera left/right and up/down until the white filled circle is in the centre and turns green.

Note!

In live view, press the rectangle button until the spirit level overlay is shown.

General settings menu

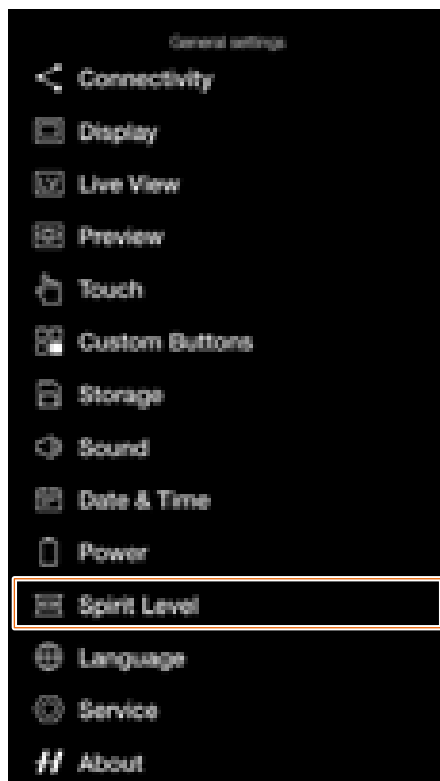

Spirit level when camera is aligned

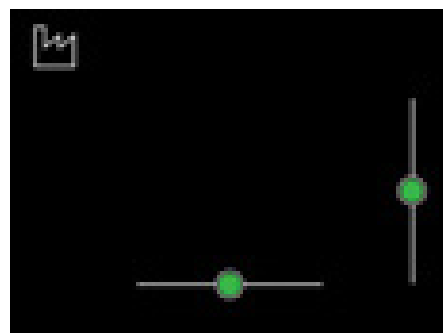

Spirit level when camera is tilted a little to the right and more down.

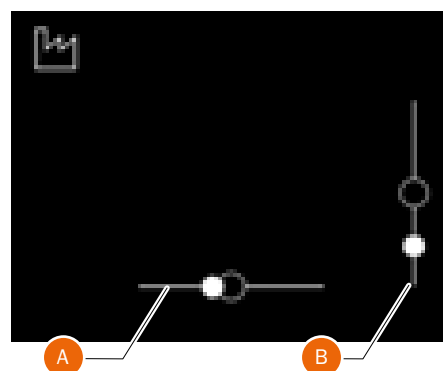

Camera tilted to the left.

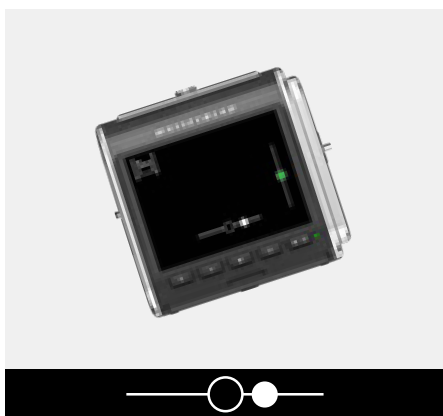

Camera aligned horizontally and vertically.

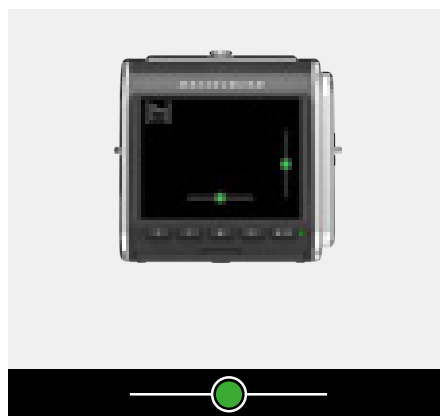

Camera tilted to the right.



Camera tilted up.



Camera aligned vertically.



Camera tilted down.



CALIBRATE SPIRIT LEVEL

MAIN MENU > GENERAL SETTINGS > SPIRIT LEVEL

The spirit level can be set to factory or user mode. In user mode, the spirit level can be calibrated by the user. This could be used to return to a specific camera position. In factory mode, the calibration from the factory is used.



Factory mode.



User mode.

How to calibrate Spirit Level

- 1 Press the General Settings icon on the main menu display.
- 2 The General settings menu appears.
- 3 Press the General Settings Spirit level icon.
- 4 Press the icon in the top left corner (A).
- 5 The Spirit level dialogue appears.
- 6 Align the camera carefully both horizontally and vertically.
- 7 Press Calibrate (B).
- 8 The two white circles are now moved to their centre position. When in their centre position, they turn green.

Swipe right or press the menu button to get back to the main menu.

How to reset spirit level to factory calibration

- 1 Press the General settings icon on the main menu display.
- 2 The General Settings menu appears.
- 3 Press the General Settings Spirit Level icon.
- 4 Press the icon in the top left corner (A).
- 5 The Spirit Level dialogue appears.
- 6 Press the Factory settings icon (C).
- 7 The Factory settings icon (D) is now displayed and the Spirit Level is reset to Factory calibration settings.

Note! The calibration stored in the user mode will remain until changed.

Swipe right or press the menu button to get back to the main menu.

General settings menu

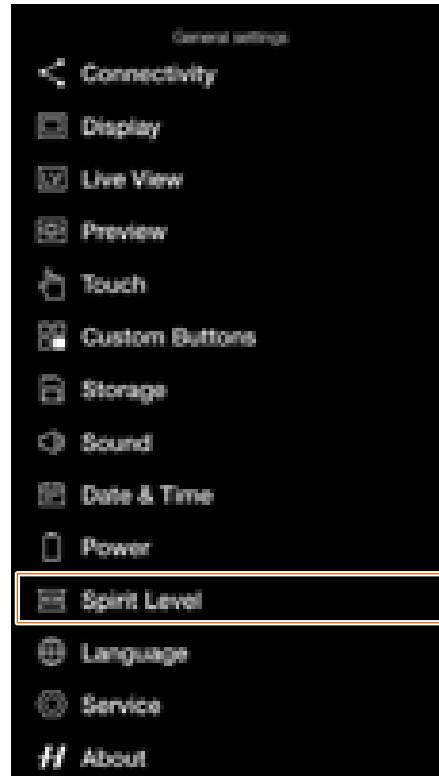

Spirit level when camera is aligned

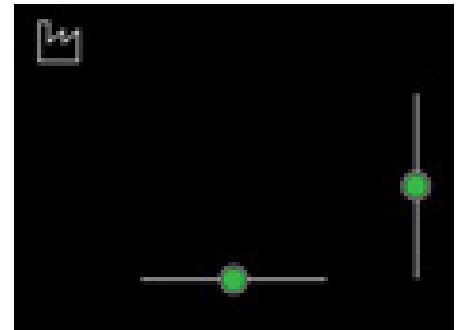

Spirit level when camera is tilted a little to the right and more down.

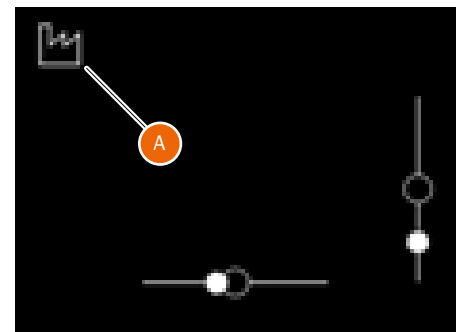

Spirit level when calibrated by user.

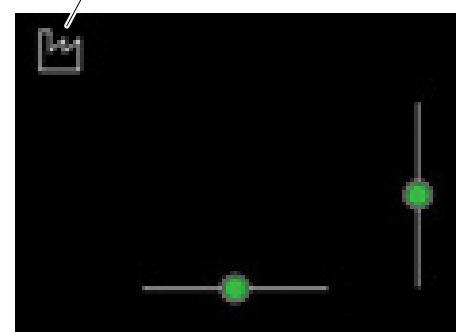
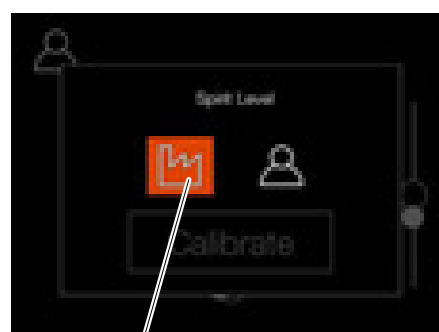
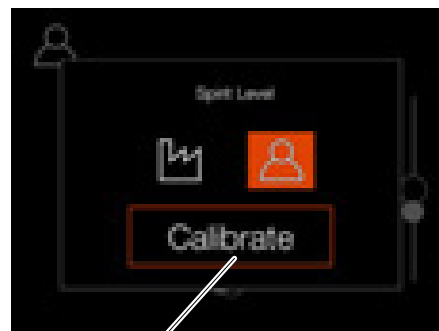
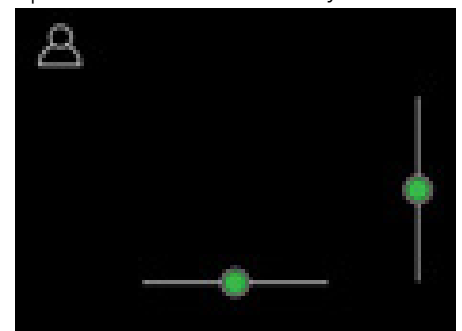

LANGUAGE

MAIN MENU > GENERAL SETTINGS > LANGUAGE

- 1 Press the General Settings icon on the touch display.
- 2 The General Settings menu appears.
- 3 Press the Language menu.

Swipe right or press the menu button to get back to the main menu.

How to change language

- 1 Press the menu button.
- 2 Navigate to General settings.
- 3 Navigate to Language.
- 4 Select Language.
- 5 Tap the language **(A)** and select a new language from the list.
- 6 To exit without changing language, tap outside the pop up **(B)**.

Available Languages:

- English
- Spanish
- French
- German
- Italian
- Swedish
- Russian
- Japanese
- Simplified Chinese
- Traditional Chinese
- Korean

Note!

If the camera has been set to a language you do not understand, see page 154 for a solution.

General settings menu

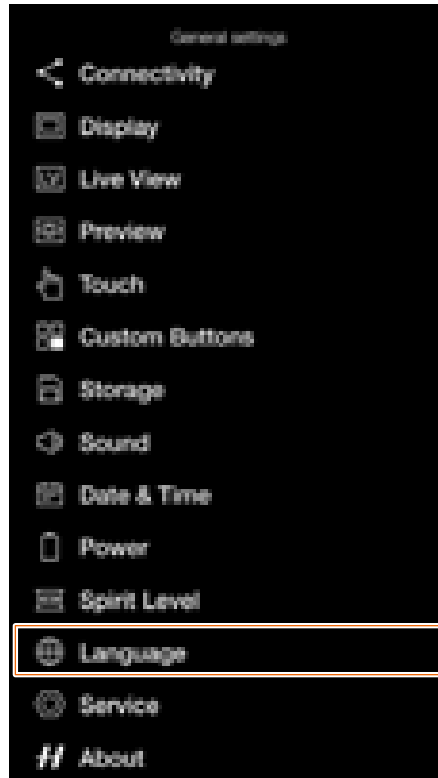

Language menu

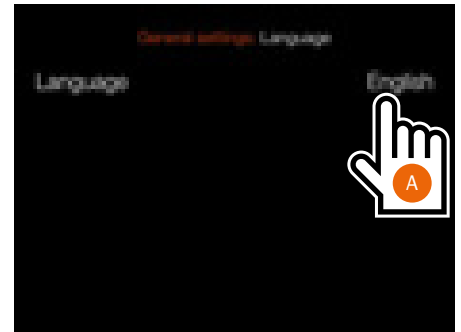

Language setting



SERVICE

MAIN MENU > GENERAL SETTINGS > SERVICE

- 1 Press the General Settings icon on the touch display.
- 2 The General Settings menu appears.
- 3 Press the General Settings Service icon.

Swipe right or press the menu button to get back to the main menu.

Service menu settings

Firmware Update

Locate firmware file on the SD Card. See page 144.

Log Data

Press **Save to Card** to save log data as a file on the active card. See page 146.

Default Settings

Reset all Settings. See page 147.

File Counter

Reset the file counter. See page 148.

General settings menu

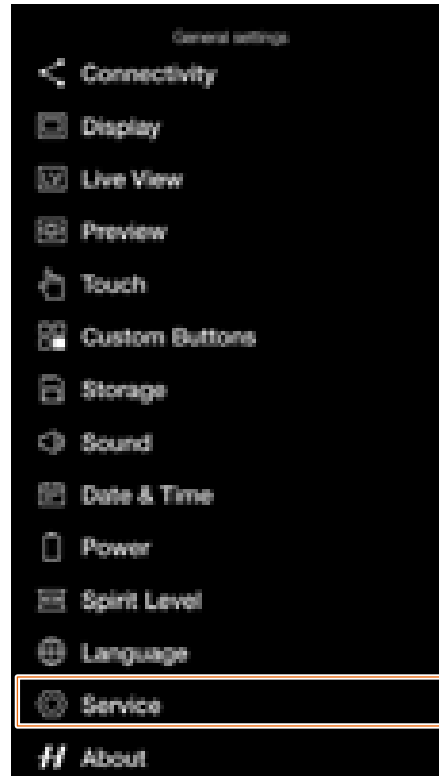

Service menu

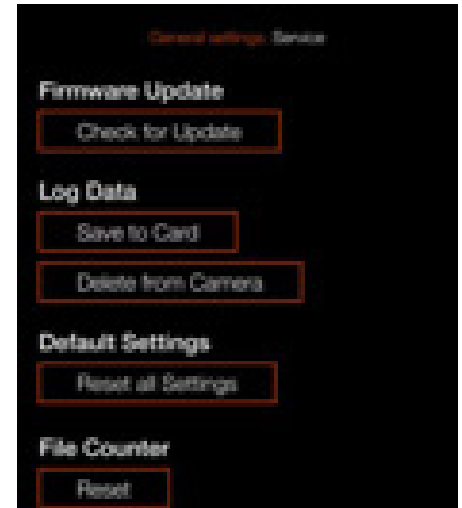

FIRMWARE UPDATE

MAIN MENU > GENERAL SETTINGS > SERVICE > CHECK FOR UPDATE

- 1 Press the General Settings icon on the touch display.
- 2 The General Settings menu appears.
- 3 Press the Service menu.
- 4 Press the Check for Update button.
- 5 The camera will now check the inserted card/cards for update files.

Swipe right or press the menu button to get back to the main menu.

Update firmware procedure

- 1 Download the latest firmware at www.hasselblad.com.
- 2 Save the firmware file to an SD Card.
- 3 Insert the SD card in the camera.
- 4 Select Settings from the main menu.
- 5 Select Service / Firmware Update / Check for Update.
- 6 Make sure the firmware file name and number corresponds to the latest Firmware File you have downloaded.
- 7 Select Update.
- 8 Select Update in the Update confirm dialogue to start the firmware update.
- 9 During the update the text "Update in progress" is displayed on the camera display.
- 10 Do not turn off the camera during the update process.
- 11 The update will take several minutes.
- 12 When the update is finished this text will be displayed: "Update Finished".
- 13 The new firmware is now installed and the camera is ready to use!

General settings menu

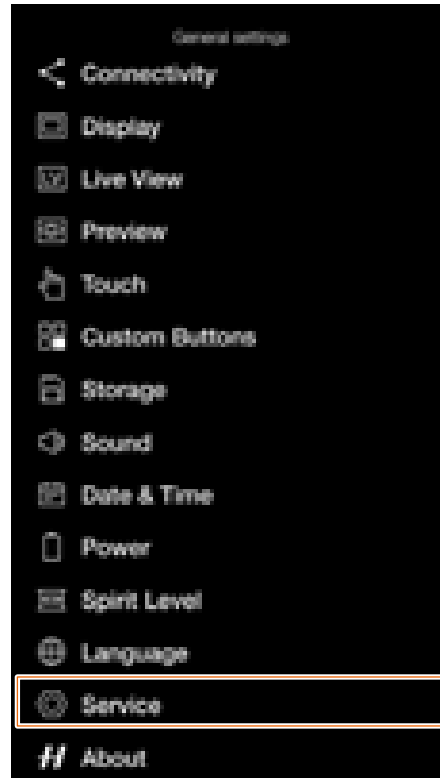

Service menu

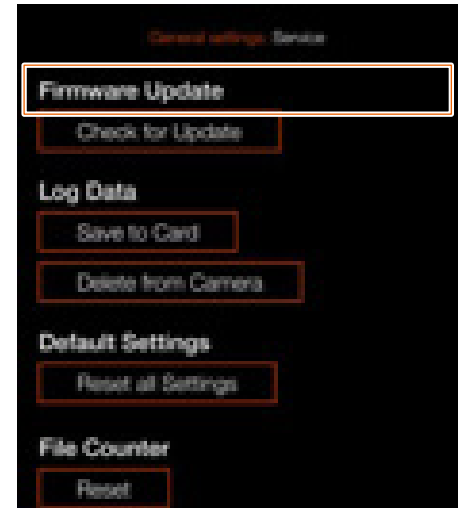

Check for update dialogue

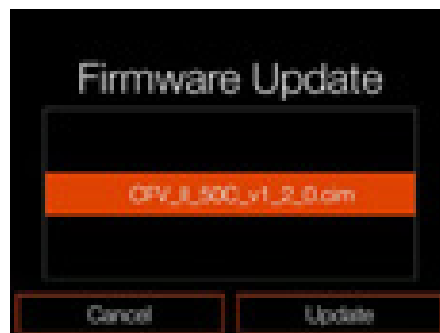

Update confirm dialogue

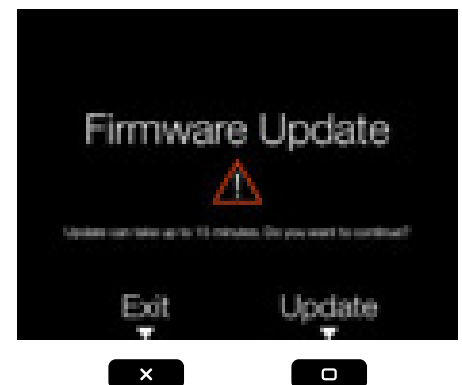

No firmware update files are available on the SD card

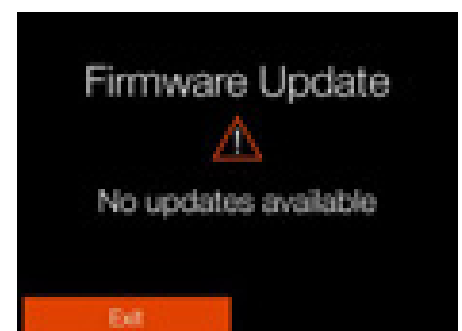

LENS FIRMWARE UPDATE

MAIN MENU > GENERAL SETTINGS > SERVICE > CHECK FOR UPDATE

- 1 Press the General Settings icon on the touch display.
- 2 The General Settings menu appears.
- 3 Press the Service menu.
- 4 Press the Check for Update button.
- 5 The camera will now check the inserted card/cards for update files.

Swipe right or press the menu button to get back to the main menu.

Lens Firmware Update Procedure

- 1 Attach the lens to the camera.
- 2 Download the latest XCD Lens Firmware from www.hasselblad.com.
- 3 Save the Firmware file to an SD card.
- 4 Insert the SD card in the camera.
- 5 Select Settings from the main menu.
- 6 Select Service / Firmware Update / Check for Update.
- 7 Make sure the firmware file name and number corresponds to the latest firmware file you have downloaded.
- 8 Select Update.
- 9 Select Update in the update confirm dialogue to start the lens firmware update.
- 10 During the update the text "Update in progress" is displayed on the camera display.
- 11 Do not turn off the camera during the Update process.
- 12 The update will take several minutes.
- 13 When the update is finished this text will be displayed: "Update is completed!".
- 14 The new lens firmware is now installed and the lens is ready to use!

General settings menu

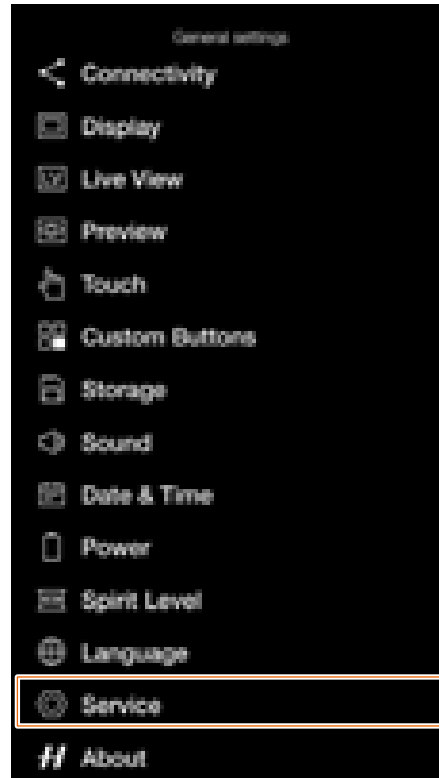

Service menu

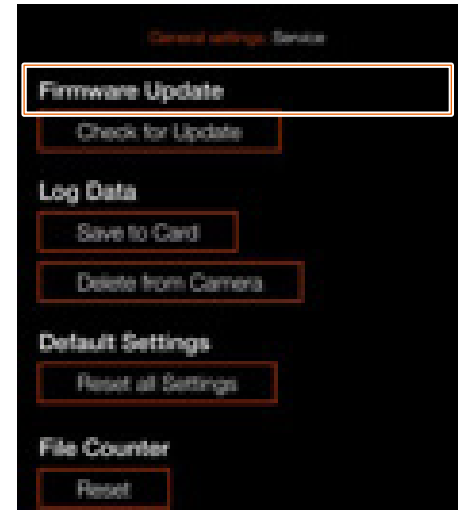

Check for update dialogue



Update confirm dialogue

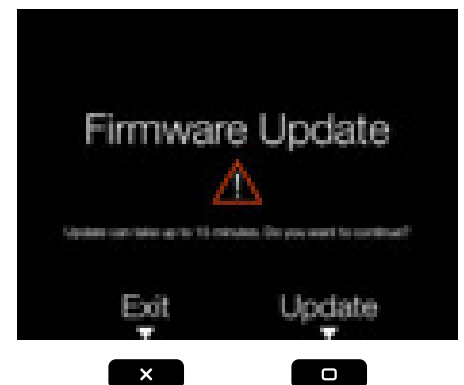

No firmware update files are available on the SD card

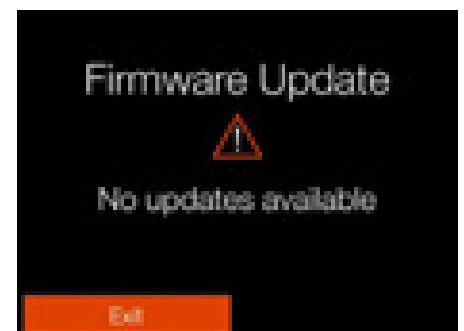

LOG DATA

MAIN MENU > GENERAL SETTINGS > SERVICE > CHECK FOR UPDATE

- 1 Press the General Settings icon on the Touch Display.
- 2 The General Settings menu appears.
- 3 Press the Service menu.
- 4 Press the **Check for Update** button.
- 5 The camera will now check the inserted card/cards for update files.

Swipe right or press the menu button to get back to the main menu.

Log Data settings

Save to Card

Saves the content of the log data memory in the camera to the SD card.

Delete from Camera

Erases the content of the log data memory in the camera.

How to save Log Data:

- 1 Press MENU.
- 2 Tap the General Settings icon.
- 3 Navigate to Service.
- 4 Navigate to Log Data.
- 5 Press the **Save to Card** button to save a log file on the active card.
- 6 Press the menu button to exit.

How to delete Log Data:

- 1 Press the menu button.
- 2 Tap the General Settings icon.
- 3 Navigate to Service.
- 4 Navigate to Log Data.
- 5 Press the **Delete from Camera** button.
- 6 In the confirm dialogue, press Delete (rectangle button).
- 7 Press the menu button to exit.

General settings menu

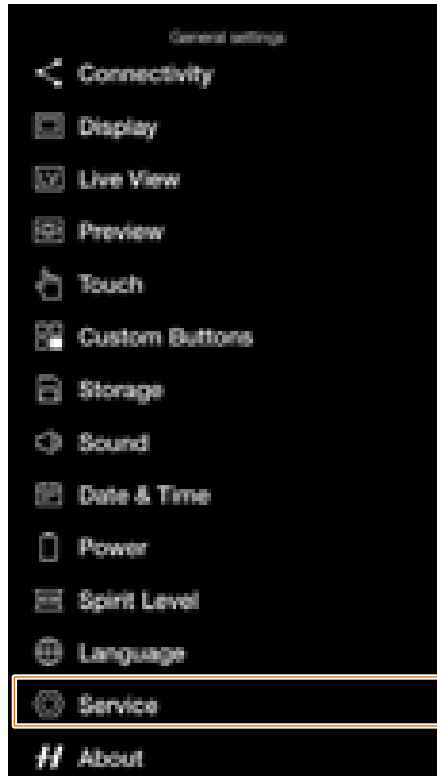

Service menu

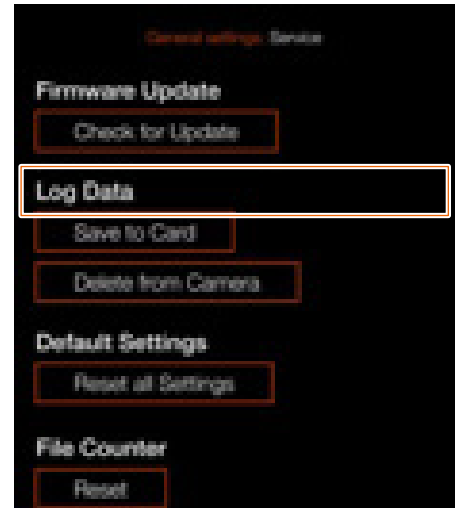

Saving log data

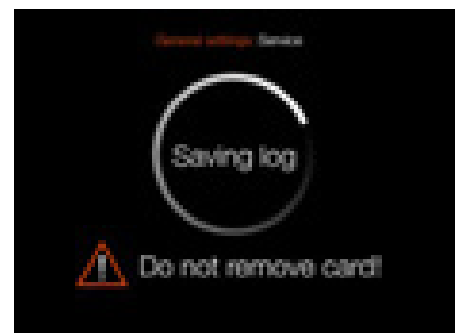

Delete log data confirm dialogue

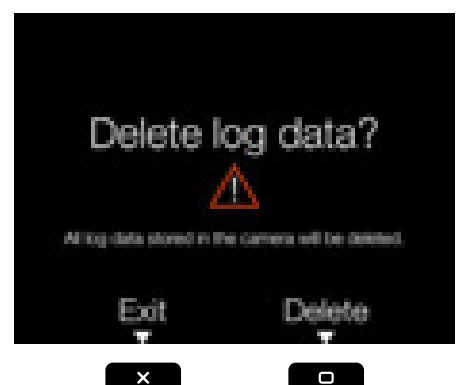

DEFAULT SETTINGS

MAIN MENU > GENERAL SETTINGS > SERVICE > DEFAULT SETTINGS

- 1 Press the Settings icon on the touch display.
- 2 The General settings menu appears.
- 3 Press the Service menu.
- 4 Press the **Check for Update** button.
- 5 The camera will now check the inserted card/cards for update files.

Swipe right or press the menu button to get back to the main menu.

How to reset all settings to the default setting:

- 1 Press the menu button.
- 2 Tap the General Settings icon.
- 3 Navigate to Service.
- 4 Press "Reset all Settings".
- 5 A "Reset all Settings" confirmation dialogue appears.
- 6 Select Reset to reset all settings.
- 7 After confirmation, all settings will be reset to default values.

Note!

Select Exit to exit without resetting.

General settings menu

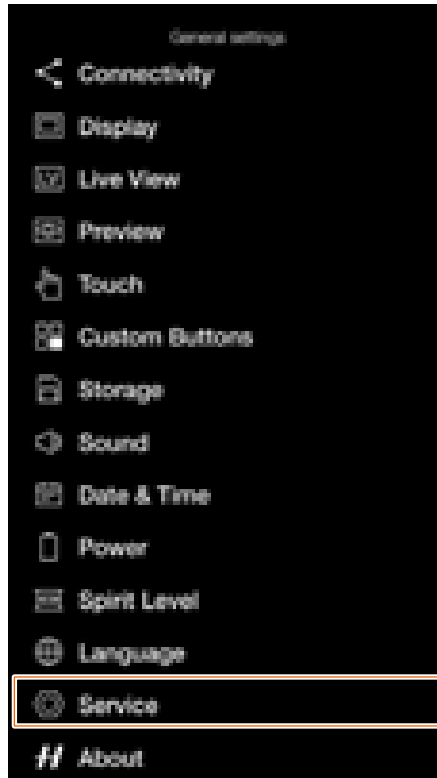

Service menu

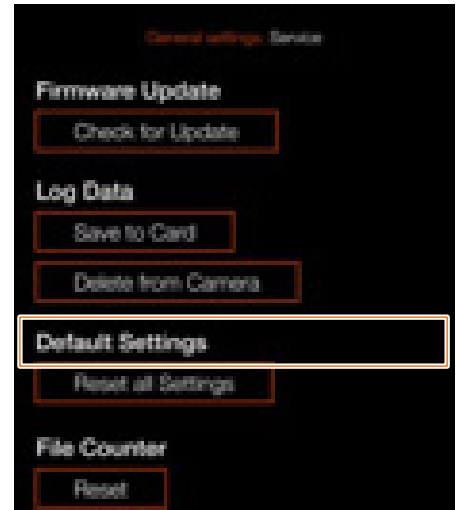

Reset all Settings dialogue.

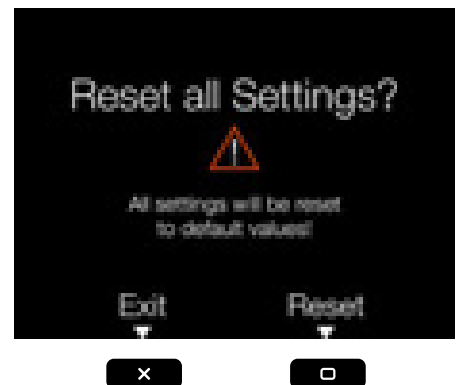

RESET FILE COUNTER

MAIN MENU > GENERAL SETTINGS > SERVICE > FILE COUNTER

- 1 Press the General Settings icon on the touch display.
- 2 The General Settings menu appears.
- 3 Press the Service menu.
- 4 Select **Reset** under File Counter.

Swipe right or press the menu button to get back to the main menu.

How to reset the file counter:

- 1 Press the menu button.
- 2 Tap the General Settings icon.
- 3 Navigate to Service.
- 4 Under File Counter, select Reset.
A dialogue will appear asking for confirmation.
- 5 Press OK.
- 6 After confirmation, the file counter will be reset and the next captured image (or video recording) will be numbered B00000001.
- 7 If the current folder on the memory card is not empty when a reset is performed, a new folder will be created on the memory card. This is done to avoid the possibility of two captured images being labelled with the same name and file number.

Note!

A new folder is created if there are images present on any inserted active SD memory card.

General settings menu

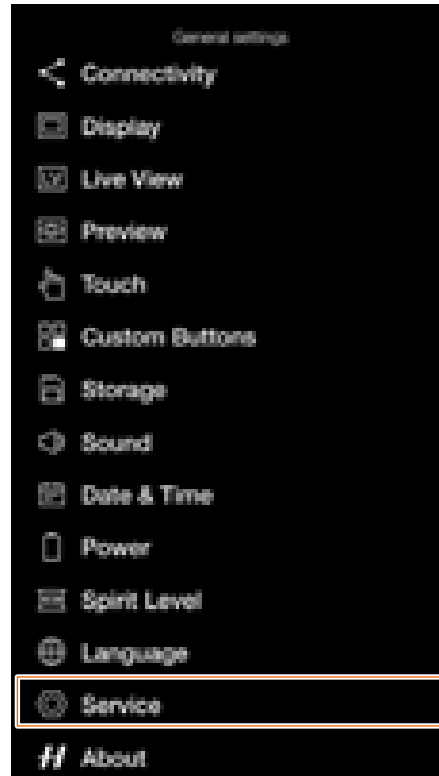

Service menu

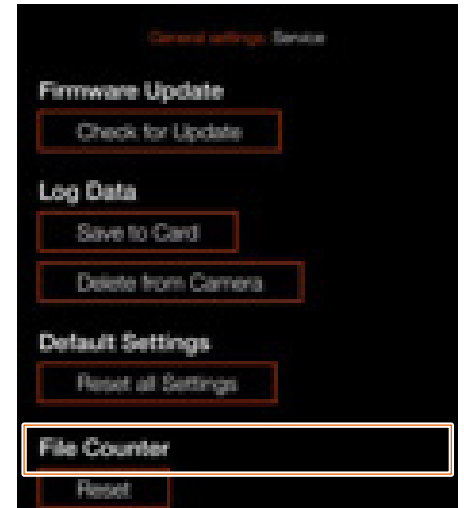

Confirm dialogue

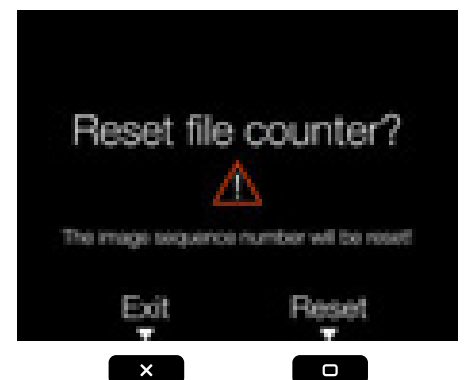

File counter reset dialogue

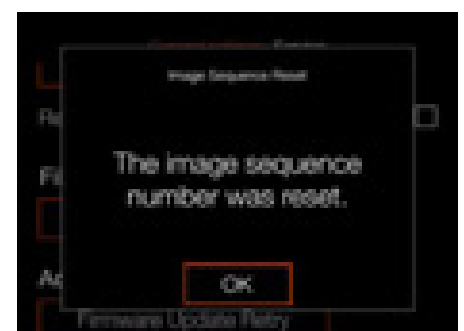

ABOUT

MAIN MENU > GENERAL SETTINGS > ABOUT

- 1 Press the General Settings icon on the touch display.
- 2 The General Settings menu appears.
- 3 Press the About icon.

Swipe right or press the menu button to get back to the main menu.

About Menu Settings

CFV Model

The model name of the attached CFV.

CFV Firmware

Shows which firmware version is installed in the CFV. Here you can see if you have the latest firmware (can be downloaded at the Hasselblad website).

907X Firmware

Shows the firmware version that is installed in the 907X.

Lens Firmware

Shows the installed firmware version in the attached lens.

Serial Number

The serial number of the CFV II.

Licenses

Displays the available Licenses. Tap each line for more information.

Usage

Displays the total number of the currently mounted lens exposures. 1603 in this example on the right.

General Settings Menu

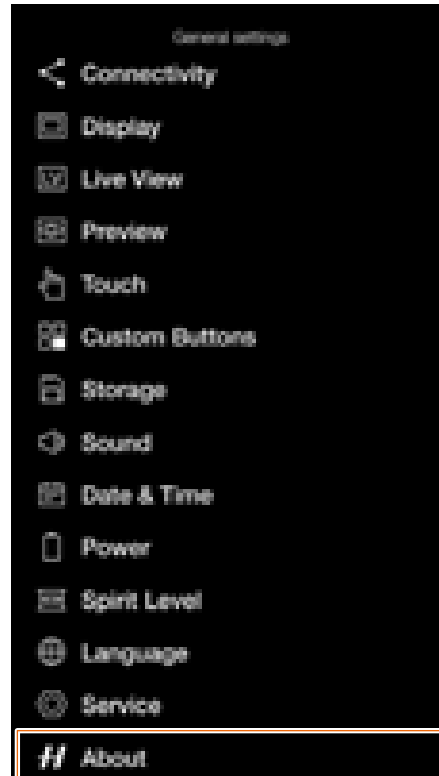

About Menu



Licenses dialogue



Usage dialogue



For a complete list of accessories, see <https://www.hasselblad.com/x-system-accessories/>

XH LENS ADAPTER

CP.QT.00000290.01

The XH Lens Adapter can be used to mount an HC or HCD Lens onto the 907X Camera.

The XH Lens Adapter widens your lens choices to include all 12 H-system HC/HCD lenses, and accessories including a macro converter and 3 extension tubes.

The HC/HCD lens range includes a 24 mm wide-angle lens, a 300 mm telephoto lens and a 100 mm f 2.2 lens, delivering small depth-of-field range and a beautiful, smooth Bokeh.

Note!

Currently the 907X Camera supports the XH Lens Adapter with Auto Focus for all HC/HCD Lenses, except the HC 120 Macro. Converters and extension tubes can also be used with AF.

Note!

Only HC/HCD lenses with firmware 18.0.0 or later can be updated for AF functionality. Lenses with older firmware have older hardware and cannot be updated with this firmware. They can only be used in Manual Focus Mode.



XV LENS ADAPTER

CP.HB.00000241.01

The XV lens Adapter is used to attach Hasselblad V System lenses to the 907X. Compatible with all V System lenses (C, CF, CFi, CFE, CB, F and FE)

Note!

This requires the electronic shutter function of the camera to be activated. See more on page 113.

Note!

You can use Focus Peaking or 100% zoom in to assist manual focusing.

Note!

Lens corrections for V System lenses are available with Phocus version 3.4 or later. Note that they have to be manually selected.

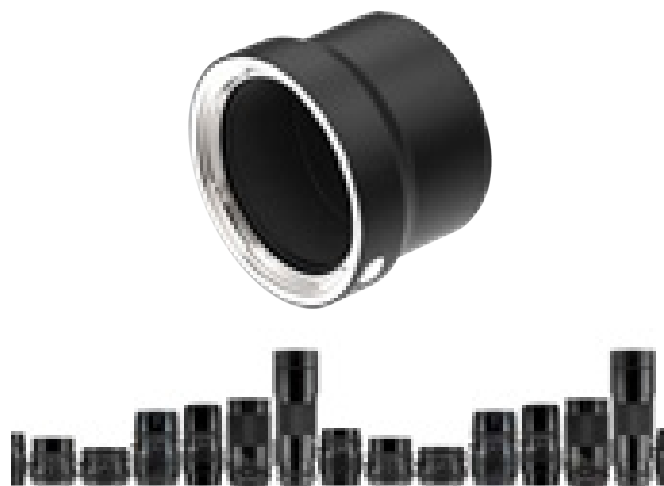

TRIPOD MOUNT RING 75MM

CP.HB.00000217.01

The tripod mount ring is designed to fit the XH/XV lens adapters and the X Converter 1.7, giving additional support when using long or heavy HC/HCD or V System lenses. The tripod mount ring can be fitted to 1/4" and 3/8" tripod threads or the Hasselblad Quick Coupling Plate H.



XPAN LENS ADAPTER

CP.HB.00000036.01

The XPan Lens Adapter is used to attach lenses that was made for the XPan Camera. Available XPan lenses were 5,6/30mm, 4/45mm and 4/90mm.

Note!

XPan Lenses had no built-in shutter. Consequently, they can only be used when the electronic shutter of the camera is activated. See more on page 113.

Note!

You can use Focus Peaking or 100% zoom in to assist manual focusing.



RELEASE CORD X

CP.HB.00000242.01

The Hasselblad Release Cord X allows for remote shutter control, helping to eliminate shake or vibration. A durable cloth-wrapped 90cm (36 inch) cable connects to the microphone input of the 907X and the simple single button operation allows photographers to keep vibration to a minimum. Its durable metal construction combined with its slim, ergonomic design fits comfortably in the hand. Release Cord X comes with a small leather carry pouch.



BATTERY CHARGING HUB

CP.HB.00000397.01 (EMEA)

CP.HB.00000395.01 (United Kingdom)

CP.HB.00000392.01 (North America/Japan)

CP.HB.00000396.01 (China)

CP.HB.00000393.01 (South Korea)

CP.HB.00000394.01 (Australia/New Zealand)

Streamlining the battery charging process, the Hasselblad Battery Charging Hub contains dual slots that support the simultaneous charging of two batteries. An integrated USB Type-C connector supports mains power via an included power supply or from common external USB battery banks (sold separately). Front-facing LEDs indicate status and capacity when charging, or users can use the Battery Charging Hub to check battery levels simply by inserting a battery and pressing a single button.



12.1 CHANGE FROM A FOREIGN LANGUAGE

MAIN MENU > GENERAL SETTINGS
> LANGUAGE

- 1 Press the General Settings icon on the touch display **(B)**.
- 2 The General Settings menu appears.
- 3 Navigate to the menu item with a Globe icon.
- 4 Tap the text to the right **(A)**.
- 5 Scroll down to select your Language.

Swipe right or press Menu / EXIT button to get back to main menu.

General Settings Menu

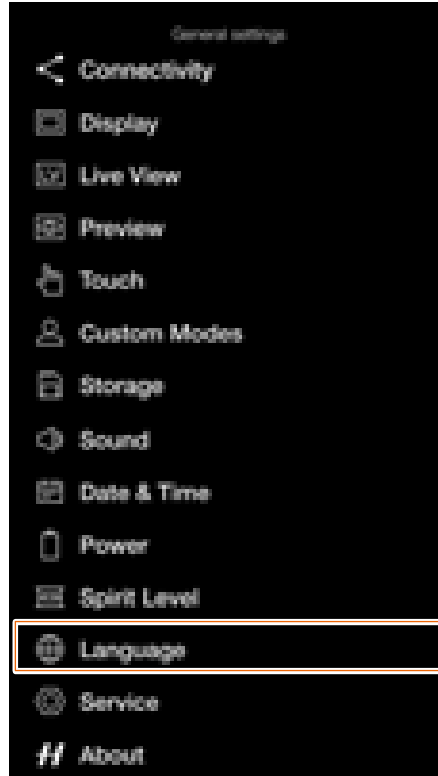

Language Menu

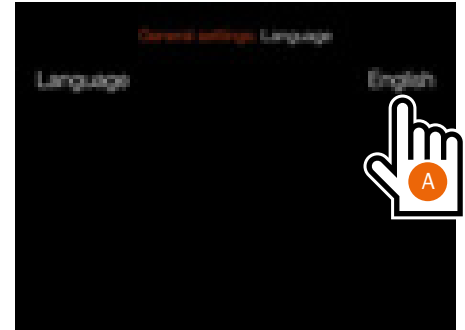

Language Setting



12.2 CLEAN THE SENSOR FILTER

Caution!

Be careful when you attach/remove the components to/from the camera. This will help prevent damage to the data bus connections.

Caution!

When you remove the lens, keep foreign objects away from the camera opening. The camera opening is very sensitive. This will help prevent damage to the equipment.

Remove the Lens and clean the Sensor

- 1 Remove USB 3 cable if connected.
- 2 Press and hold the Lens Release button.
- 3 Rotate the Lens counter clockwise.
- 4 Remove the lens.
- 5 Carefully clean the outside surface of IR filter by using clean compressed air.

Caution!

If you use canned compressed air to clean the glass of IR filter, read the instructions very carefully before use. This will help prevent damage to the filter.

If compressed air did not remove all the problems and you still see dust spots in the images, you may have dust either on the inside of the IR filter or on the CMOS itself, please contact your Hasselblad dealer.

Caution!

Do not try to remove the glass IR filter from the front of the sensor (due to dust or similar). This will cause damage to the equipment.

12.3 CLEAN THE LENS GLASS SURFACE

REMOVE DUST

Caution!

Do not touch the glass surface with your fingers. This can cause damage to the equipment.

If there is dust on the lens glass, do as follows:

- 1 Remove the dust with an air blower.
- 2 If that does not solve the problem, try to remove dust with a very soft lens brush.

REMOVE SMEAR

Caution!

Do not touch the glass surface with your fingers. This can cause damage to the equipment.

If there is smear on the lens glass, do as follows:

- 1 If you are not sure how to remove the smear, contact your local Hasselblad Authorized Service Centre.
- 2 Clean the lens glass with a high quality lens cleaning solution on a tissue.

12.4 ERROR MESSAGES

If any error message is displayed

- 1 Remove the components from the camera.
- 2 Attach the components to the camera again.

If the error message is still displayed

- 1 Remove the battery.
- 2 Remove any connected USB cable.
- 3 Wait 10 seconds.
- 4 Attach the battery again.
The Camera processor is now reset.

If the error message is still displayed

- 1 Write down the error message.
- 2 Contact your closest authorized Hasselblad dealer.

12.5 INFORMATION ABOUT THE 907X USER GUIDE

The information in this user guide is intended for informational use only. The information and the 3D Product Images and Photos, are subject to change without notice, and should not be construed as a commitment by Victor Hasselblad AB.

UPDATES

Updates to this user guide will be issued regularly. Please check www.hasselblad.com for the latest version. If you are a registered user, you will get mail notifications when a new version is available.

3D PRODUCT IMAGES

The Product Images in this user guide were not taken with a Hasselblad camera. They are produced in 3D as visualization. They are used for illustrative purposes only and are not intended to represent the image quality produced by Hasselblad cameras.

TRADEMARKS

Hasselblad, Phocus, Phocus Mobile and Phocus Mobile 2 are trademarks of Victor Hasselblad AB.

Adobe and Adobe Photoshop are trademarks of Adobe Systems, Inc. Macintosh, Mac OS, iPhone® and iPad® are trademarks of Apple.

Helicon Focus is a trademark of Helicon Soft.

Sandisk, Panasonic, Toshiba and Sony are trademarks of their respective corporations.

COPYRIGHT

All text in this user guide copyright © Victor Hasselblad AB. All images in this User Guide, not credited to a specific photographer, copyright © Victor Hasselblad AB. The text, or parts of the texts, in this manual cannot be reprinted or reused without the written express permission of Victor Hasselblad AB.

The images in this User Guide cannot be reprinted or reused without the written express permission of the photographers who owns the copyright.

Victor Hasselblad AB assumes no responsibility or liability for any errors or inaccuracies that may appear in this User Guide. Victor Hasselblad AB assumes no responsibility or liability for loss or damage incurred during, or as a result of using Hasselblad software or products.

Copyright © 2020 Victor Hasselblad AB. All rights reserved.