

VARI-PRO

500 SERIES / 700 SERIES / 1000 SERIES

VARI-PRO

500 SERIES / 700 SERIES / 1000 SERIES

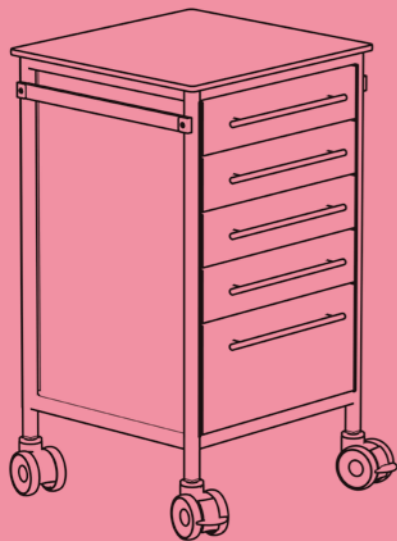

Meet our Procedure Carts. Vari-Pro.

Utilising the same simple, yet durable construction as our Vari-Cart ranges, the Vari-Pro Procedure Carts are built to last and provide a cost-effective long-term solution.

There are plenty of upgrades to make your cart work for you even harder: upgradeable worktops, hook-over accessories, drawer-tidy dividers and digital keyless locks.

Customisation is in your hands, with plenty of options like drawer-front colours and drawer depths and combinations, all free of charge.

[Explore our Vari-Pro cart range >](#)

What is included on the base models?

The base models for our Vari-Pro range have multiple options, including choosing your ideal height and width, colour of drawer-fronts and drawer size combinations, which come as standard so you can customise your cart at no extra cost. If you would like to upgrade components or add optional extras, there are plenty to choose from so you can easily create the cart that suits your needs.

VARI-PRO
500 SERIES

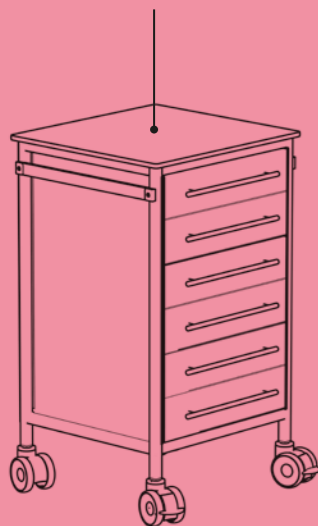

VARI-PRO
700 SERIES

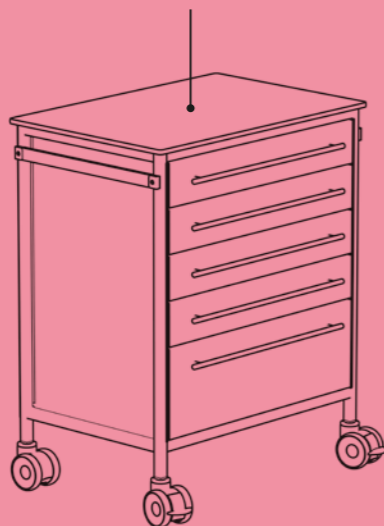

VARI-PRO
1000 SERIES

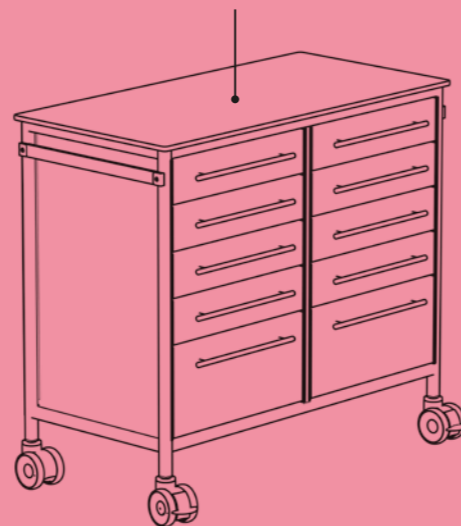

1. CHOOSE YOUR
CART DIMENSIONS
(2 heights, 3 widths available)

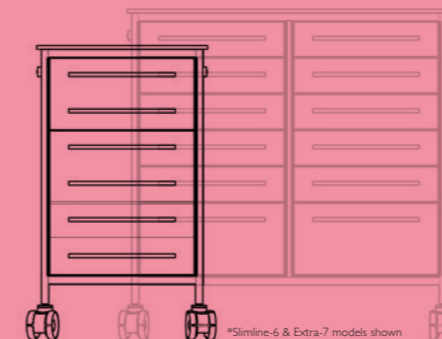

*Slimline-6 & Extra-7 models shown

2. CHOOSE YOUR
DRAWER COLOURS
(8 options available)



3. CHOOSE YOUR
DRAWER SIZES
(in any combination)

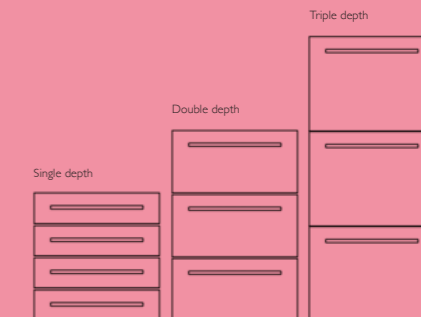

4. CHOOSE YOUR HOOK-OVER ACCESSORIES* (optional, see page 22-25)

WHY BUY FREEWAY? BECAUSE ALL

THESE FEATURES ARE STANDARD!



Drawer Colour Choice

Choose from a selection of 8 colours to have the drawer-fronts painted in. Make a block impact or mix it up with a combination, the choice is yours.



Ultra Heavy-Duty Castors

Featuring a triple ball-race bearing set, our castors and rubberised tyres are built to last and ensure effortless manoeuvring of a fully stocked cart.



Super-Tough Nylon Paint

All components used, large or small, are resistant to everyday knocks and scrapes with an extremely durable and easy-clean nylon powder coat paint finish.



Any Drawer Configuration

Choose the combination of drawer sizes that suit the intended purpose of the cart and the stock and equipment it will eventually hold.



Built-In Accessory Rails

Our simple hook-over accessories give the Vari-Pro cart endless upgrade options which help tailor the cart to the users' specific needs.



Fully Assembled

The Vari-Pro range comes to you fully assembled and ready to roll into use. Simply unpack from the box and your cart can be put into action.



PRODUCT CODE
VARI-PRO SLIMLINE-6

The Vari-Pro Slimline cart with 6 drawer spaces is a versatile, unobtrusive storage solution with a solid Trespa worktop and sleek finish that fits into hospitals for efficient use of space.

DIMENSIONS
Height = 910mm Width = 530mm Depth = 540mm

PRODUCT ELEVATIONS (excluding accessories)

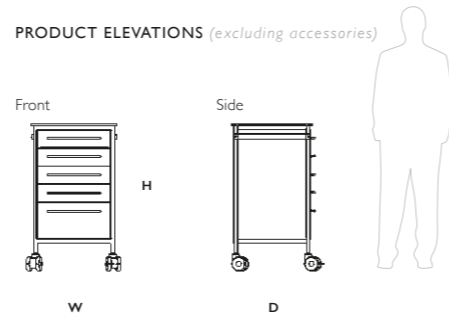

DRAWER COLOURS (included in price)

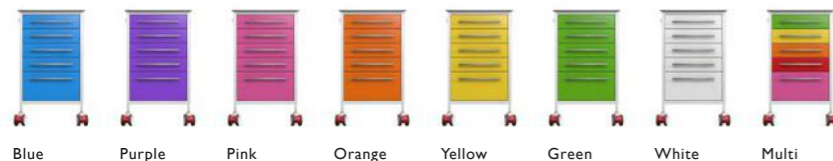

STAINLESS STEEL WORKTOP UPGRADE

All our Vari-Pro carts can be upgraded to a stainless steel raised-lip worktop.



CHOOSE YOUR OWN DRAWER COMBINATION

All models in our Vari-Pro range come with standardised drawer combinations, but if the drawer mixture doesn't suit your requirements, then simply customise your drawer combination to fit your needs, completely free of charge!

Drawer depths available are:

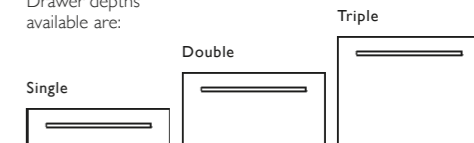

DRAWER DIVIDER SET OPTION

Efficiently organise your smaller consumables with these easy to adjust drawer dividers. See page mmm.



DIGITAL LOCK OPTION

Keyless everyday operation with master key for maintenance or forgotten codes.



ALL-METAL DRAWER CONSTRUCTION

Highly durable all-metal drawers as standard with replaceable metal drawer fronts.



HOOK-OVER ACCESSORIES (optional)

(p.22) *Consumables not included.



CALL US NOW FOR MORE INFO ON 01635 866717 OR EMAIL SALES@FREEWAYMEDICAL.CO.UK



PRODUCT CODE
VARI-PRO SLIMLINE-7

Our Vari-Pro Slimline cart boasts many features, with 7 drawer spaces you can customise to fit your needs best to make the most out of limited space.

DIMENSIONS
Height = 1010mm Width = 530mm Depth = 540mm

PRODUCT ELEVATIONS (excluding accessories)

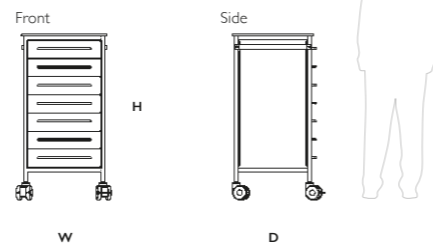

DRAWER COLOURS (included in price - Vari-Pro Slimline-6 shown for illustrative purposes)

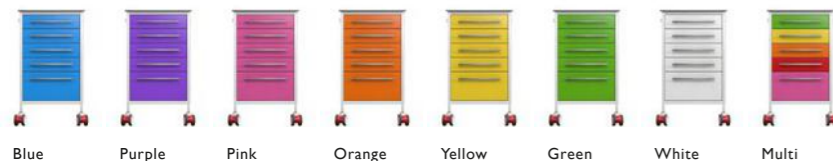

STAINLESS STEEL WORKTOP UPGRADE

All our Vari-Pro carts can be upgraded to a stainless steel raised-lip worktop.



(p.13)



CHOOSE YOUR OWN DRAWER COMBINATION

All models in our Vari-Pro range come with standardised drawer combinations, but if the drawer mixture doesn't suit your requirements, then simply customise your drawer combination to fit your needs, completely free of charge!

Drawer depths available are:

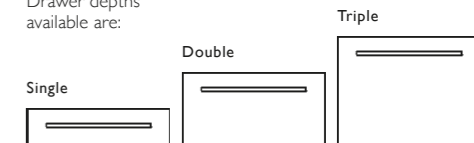

DRAWER DIVIDER SET OPTION

Efficiently organise your smaller consumables with these easy to adjust drawer dividers. See page mmm.



DIGITAL LOCK OPTION

Keyless everyday operation with master key for maintenance or forgotten codes.



(p.18)

ALL-METAL DRAWER CONSTRUCTION

Highly durable all-metal drawers as standard with replaceable metal drawer fronts.



(p.15)



PRODUCT CODE
VARI-PRO-6

At 700mm, the Vari-Pro 6 drawer space offers a flexible way to store equipment, medicine or notes which can be rolled around the ward or fixed in place.

DIMENSIONS
Height = 910mm Width = 720mm Depth = 540mm

PRODUCT ELEVATIONS (excluding accessories)

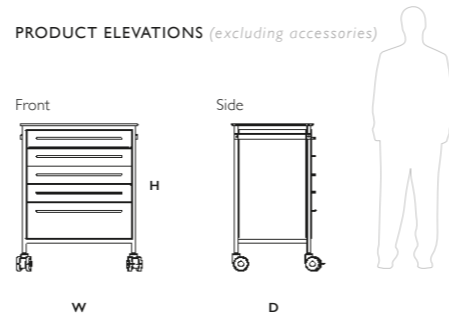

DRAWER COLOURS (included in price - Vari-Pro Slimline-6 shown for illustrative purposes)

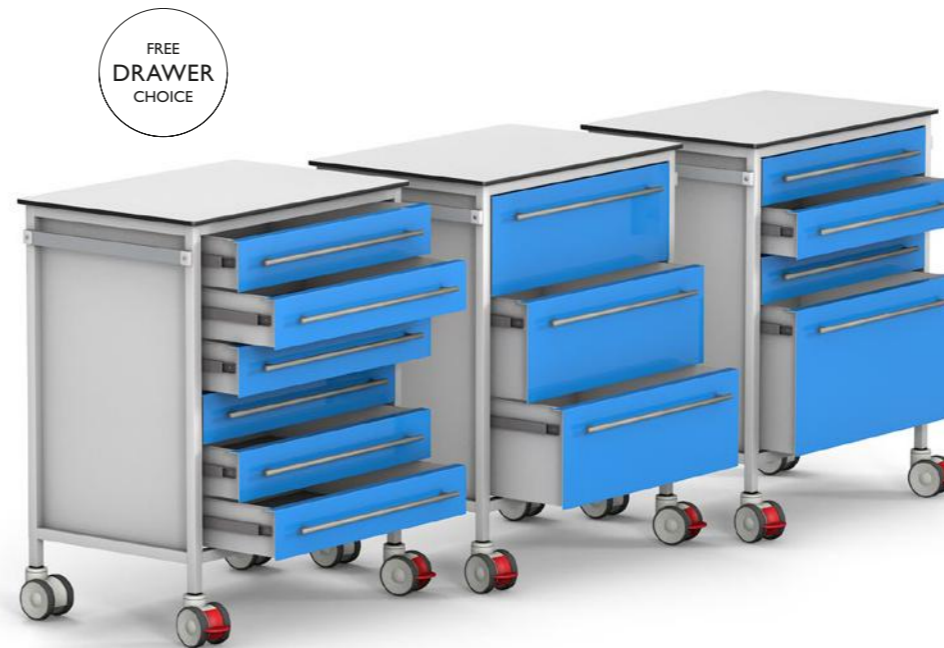
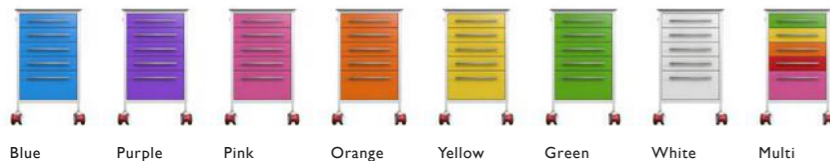

CHOOSE YOUR OWN DRAWER COMBINATION

All models in our Vari-Pro range come with standardised drawer combinations, but if the drawer mixture doesn't suit your requirements, then simply customise your drawer combination to fit your needs, completely free of charge!

Drawer depths available are:

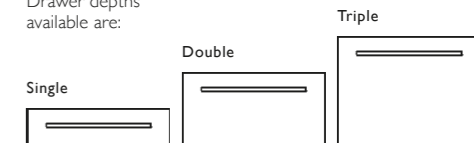

DRAWER DIVIDER SET OPTION

Efficiently organise your smaller consumables with these easy to adjust drawer dividers. See page mmm.



STAINLESS STEEL WORKTOP UPGRADE

All our Vari-Pro carts can be upgraded to a stainless steel raised-lip worktop.



(p.13)

HOOK-OVER ACCESSORIES (optional)

(p.22) *Consumables not included.



DIGITAL LOCK OPTION

Keyless everyday operation with master key for maintenance or forgotten codes.



(p.18)

ALL-METAL DRAWER CONSTRUCTION

Highly durable all-metal drawers as standard with replaceable metal drawer fronts.



(p.15)



DRAWER COLOURS (included in price - Vari-Pro Slimline-6 shown for illustrative purposes)

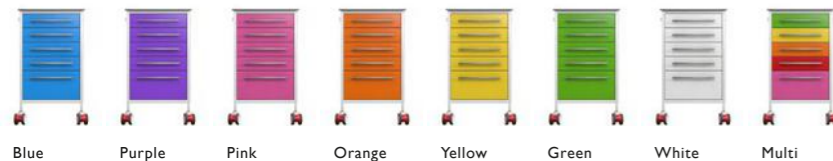

PRODUCT CODE
VARI-PRO-7

The Vari-Pro 7 drawer space is an excellent procedure cart built to last, with highly durable construction and long-lasting, stainless steel worktop upgrades available.

DIMENSIONS
Height = 1010mm Width = 720mm Depth = 540mm

PRODUCT ELEVATIONS (excluding accessories)

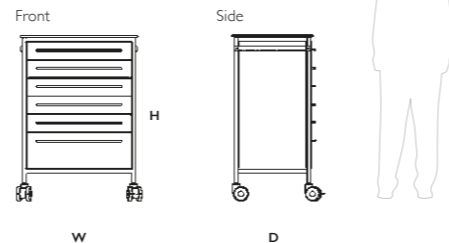

STAINLESS STEEL WORKTOP UPGRADE

All our Vari-Pro carts can be upgraded to a stainless steel raised-lip worktop.



(p.13)



HOOK-OVER ACCESSORIES (optional)

(p.22) *Consumables not included.



DIGITAL LOCK OPTION

Keyless everyday operation with master key for maintenance or forgotten codes.



(p.18)

CHOOSE YOUR OWN DRAWER COMBINATION

All models in our Vari-Pro range come with standardised drawer combinations, but if the drawer mixture doesn't suit your requirements, then simply customise your drawer combination to fit your needs, completely free of charge!

Drawer depths available are:

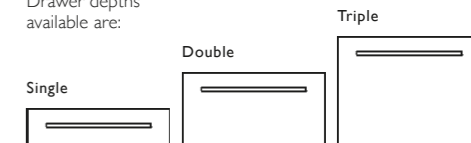

DRAWER DIVIDER SET OPTION

Efficiently organise your smaller consumables with these easy to adjust drawer dividers. See page mmm.



ALL-METAL DRAWER CONSTRUCTION

Highly durable all-metal drawers as standard with replaceable metal drawer fronts.



(p.15)



WITH
TRESPA®
WORKTOP

SEALED
REAR
PANEL

DRAWER COLOURS (included in price - Vari-Pro Slimline-6 shown for illustrative purposes)



Blue Purple Pink Orange Yellow Green White Multi

PRODUCT CODE
VARI-PRO EXTRA-6

No need for double the units when you can combine two into one that is manoeuvrable and responsive with reliable, heavy-duty castors and a fitted brake system.

DIMENSIONS
Height = 910mm Width = 1040mm Depth = 540mm

PRODUCT ELEVATIONS (excluding accessories)

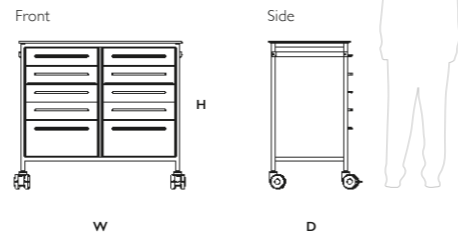

STAINLESS STEEL WORKTOP UPGRADE

All our Vari-Pro carts can be upgraded to a stainless steel raised-lip worktop.



(p.13)

FREE
DRAWER
CHOICE



HOOK-OVER ACCESSORIES (optional)

(p.22) *Consumables not included.



DIGITAL LOCK OPTION

Keyless everyday operation with master key for maintenance or forgotten codes.



(p.18)

CHOOSE YOUR OWN DRAWER COMBINATION

All models in our Vari-Pro range come with standardised drawer combinations, but if the drawer mixture doesn't suit your requirements, then simply customise your drawer combination to fit your needs, completely free of charge!

Drawer depths available are:

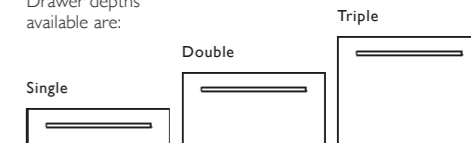

DRAWER DIVIDER SET OPTION

Efficiently organise your smaller consumables with these easy to adjust drawer dividers. See page mmm.



ALL-METAL DRAWER CONSTRUCTION

Highly durable all-metal drawers as standard with replaceable metal drawer fronts.



(p.15)



WITH
TRESPA®
WORKTOP

SEALED
REAR
PANEL

PRODUCT CODE
VARI-PRO EXTRA-7

Two lots of 7 drawer spaces create the ultimate Vari-Pro storage cart, enabling the user to have maximum storage space and a large, wide Trespa worktop to utilise.

DIMENSIONS
Height = 1010mm Width = 1040mm Depth = 540mm

PRODUCT ELEVATIONS (excluding accessories)

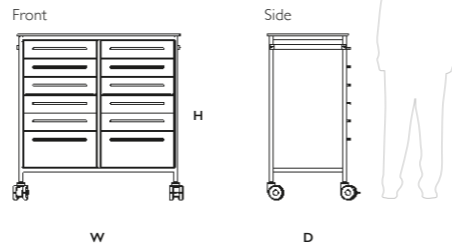

DRAWER COLOURS (included in price - Vari-Pro Slimline-6 shown for illustrative purposes)



Blue Purple Pink Orange Yellow Green White Multi

STAINLESS STEEL WORKTOP UPGRADE

All our Vari-Pro carts can be upgraded to a stainless steel raised-lip worktop.



(p.13)

FREE
DRAWER
CHOICE



CHOOSE YOUR OWN DRAWER COMBINATION

All models in our Vari-Pro range come with standardised drawer combinations, but if the drawer mixture doesn't suit your requirements, then simply customise your drawer combination to fit your needs, completely free of charge!

Drawer depths available are:

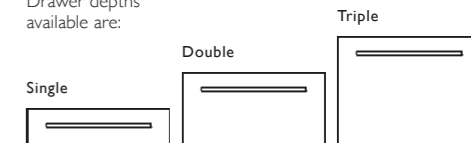

DRAWER DIVIDER SET OPTION

Efficiently organise your smaller consumables with these easy to adjust drawer dividers. See page mmm.



DIGITAL LOCK OPTION

Keyless everyday operation with master key for maintenance or forgotten codes.



(p.18)

ALL-METAL DRAWER CONSTRUCTION

Highly durable all-metal drawers as standard with replaceable metal drawer fronts.



(p.15)

HOOK-OVER ACCESSORIES (optional)

(p.22) *Consumables not included.



CALL US NOW FOR MORE INFO ON 01635 866717 OR EMAIL SALES@FREEWAYMEDICAL.CO.UK

Freeway Medical

Unit 15-16,
Colthrop Business Park,
Colthrop Lane, Thatcham,
Berkshire, RG19 4NB.

Tel: 01635 866 717

Fax: 01635 866 347

Web: freewaymedical.co.uk

Email: sales@freewaymedical.co.uk