

nienkämper
International Inc.

SEATING & MEETING PODS

2024

TABLE OF CONTENTS

How to Order Nienkämper Seating	4	Lounge Seating	55-154
Upholstery Details	5-10	32 Collection	56
Nienkämper Leather	5	Baden	57-58
Customer's Own Material (COM)	6	Bare	59
KnollTextiles	6	BASS Collection	60-61
Customer's Own Leather (COL)	6	Bay	62
Shipping Your Materials	6	Beam	63
KnollTextiles Categories and Index	7-10	Belle	64
California Technical Bulletin 133	11	Berkley® Collection	65-70
Veneers / Finishes	12	Bern	71
Office Seating	13-42	Blob	72
Rush Ship	15-16	BLOOR® Collection	73
AYA™	17	Carlisle	74
Emissary	18	Cocoon	75
Ingmar Conference	19	Divvi	76
Kris	20	Dobi	77
Nabu™	21-23	Dune Metal	78
Nienkämper NOW®	24-30	Dune Wood	79
Senator® Boardroom	31	Eden®	80-95
Senator® CEO	32	Elite	96
Senator® Classic	33	Expo 67	97
Senator® Executive	34	Godbout	98
Senator Mesh Back	35	HAB™	99
Senator® Nuvo Office	36	Heartbeat	100-101
Senit Chair	37	Ingmar Lounge	102
Shaker Chair	38	Isola 8	103
Slim	39	J + J Studio	104
Trench	40	Kloud® Collection	105
Vuelo	41	Kloud® Serpentine™	106
Side Chairs	43-54	LCS Club	107
Brackett®	44	Leaf	108
HSC	45	LINQ	109
Kush	46	LolliPOP	110
Nabu Side/Stacking Chair	47-49	Lucerne	111
Q Side Chair	50	Max™	112-118
Schultz	51	Mood Collection	119
Senator® Nuvo Sled Base	52	Nordic	120
Unesco™	53	Note	121
		Paris Archive	122
		Patkau Twist	123
		Polo Chair	124
		Pullman™	125-126
		Pyramid Chair	127
		Q Chair	128
		Radius	129

TABLE OF CONTENTS

Radius on Legs	130
Rowan	131
Satori™	132
Six® Collection	133
Spirit	134
Turnaround® Collection	135
Tuxedo™	136-137
Tuxedo Classic™	138-141
Tuxedo Cove	142-145
Tuxedo™ High Back	146-147
Vuelo Lounge	148
Wavelength®	149-150
Work:Recline	151
Yabaco	152
Zurich	153-154

Stools and Benches **155-177**

32 Bench	157
Align	158
Blottoman™	159
Caravite	160
Corbu	161
Elevation Bench	162
Exhale	163
Hocker	164
Jackal	165
Kloud® Benches	166
Max™ Benches	167
Mint	168
Moment Collection	169
Nienkämper River	170-171
Patkau Bench	172
Pullman™ Benches	173
Six Collection® Benches	174
Spin Stool/Tables	175
Wavelength® Benches	176
Zoo Stools	177

Meeting Pods	178-180
Patkau Cocoon	179
Patkau Ice Hut	180

HOW TO ORDER NIENKÄMPER SEATING

SELECT THE CHAIR:

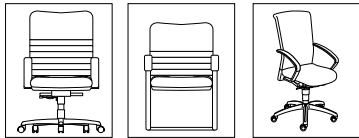

Select the style of chair that best suits your needs. All features are listed on each page.

Sample:

Standard Features:

- Pneumatic height adjustment
- Back tilt locking mechanism
- Tension control
- Carpet casters
- Black five-star base

Optional Features:

- Hard floor casters, add \$95 list per chair
- Glides, add \$95 list per chair
- Polished aluminum five-star base, add \$190 list
- Chrome finish sled base, add \$150 list

SELECT YOUR ARM TYPE:

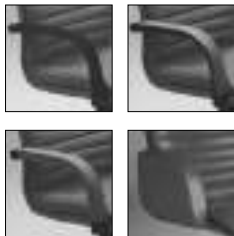

For each style of chair there are a number of arm options. These are listed under the model number with an extension. For example 1411_ is the model number for the Senator Executive low back chair. Extension #1 specifies Urethane Arm, extension #3 specifies Urethane arm with cap & wrap, and so on.

Sample:

1411_

18½"-21½" 25" 25" 26" 36"

(Model #1) Urethane arm

fabric 1¼ Yds. leather 32 Sq. Ft.

(Model #2) Urethane arm with cap

fabric 2 Yds. leather 35 Sq. Ft.

(Model #3) Urethane arm with cap & wrap

fabric 2¼ Yds. leather 37 Sq. Ft.

SELECT YOUR BASE:



At the end of each chair listing are notes indicating base options and finishes, where applicable. Review these notes and specify your base type and finish at the time you place your order.

Cross Section Example:

Standard Features:

- Pneumatic height adjustment
- Back tilt locking mechanism
- Tension control
- Carpet casters
- Black five-star base

Optional Features:

- Hard floor casters, add \$110 list per chair
- Glides, add \$110 list per chair
- Polished aluminum five-star base, add \$215 list
- Chrome finish sled base, add \$170 list

SELECT YOUR OPTIONS:

Each chair has additional options to choose from, listed on each page.

Optional Features:

- Hard floor casters, add \$110 list per chair
- Glides, add \$110 list per chair
- Polished aluminum five-star base, add \$215 list
- Chrome finish sled base, add \$170 list

SELECT YOUR FABRIC:

For each chair we have priced COM, COL, Nienkämper's three grades of leather and four grades of Knoll Textiles. Refer to the row that corresponds to the chair you are ordering.

For information on COM and COL please refer to page 6.

UPHOLSTERY DETAILS

NIENKÄMPER LEATHER:

Nienkämper is universally known for its exquisite craftsmanship in leather furniture. Nienkämper leather on Nienkämper furniture offers you and your clients the highest quality of materials as well as favorable pricing. Our Verde and Grano leather is available as COL sold to the nearest half hide. Cremoso leather is available for Nienkämper furniture only.

The Verde™ Collection:

Available in 42 colors this collection provides a varied selection of neutrals, browns, reds and blues. It is organically tanned using a chrome-free process with a water-based semi-aniline finish. These improved techniques result in a more natural character, combined with a softer touch and brighter colors that are consistent from batch to batch.

Raw Material: Scandinavian Cow Hide

Thickness: 1.1-1.3 mm

Type: Chrome-free tanned with a water-based semi-aniline finish. Full natural grain, excellent durability yet soft and pliable, suitable for public environments. Some visible healed scars add natural character to this leather.

Average Hide Size: 55 sq.ft.

The Grano® Collection:

The perfect balance between strength and softness. Semi-aniline Grano™ has exceptional natural beauty and pliancy. An easy-to-clean finish makes this leather appropriate for seating in reception areas, meeting rooms and managerial offices.

Raw Material: European Cow Hide

Thickness: 1.2-1.4 mm

Type: Semi-aniline dyed.

Average Hide Size: 55 sq.ft.

The Neather Collection:

Available in 8 colours, Neather is a synthetic material similar to vinyl. It comes in a standard 54" width. Neather is easy to clean and a good option for accessory or upholstery items.

To request leather samples please contact your local sales representative, for a listing or call Nienkämper Customer Service at 800.668.9318.

UPHOLSTERY DETAILS

CUSTOMER'S OWN MATERIALS (COM):

Nienkämper reserves the right to determine the suitability of a particular COM on our furniture. If we determine, in our judgment, that the COM is inappropriate for use on a particular product we will notify the customer. If you have any questions on the appropriateness of your COM please submit a sample to Customer Service prior to your order.

KNOLLTEXTILES:

All Nienkämper seating available in fabric includes pricing for four grades of fabric, see the KnollTextiles grade columns throughout this book. All fabric orders should be made when ordering the furniture. For KnollTextiles samples contact the KnollTextiles Customer Service department at 1.866.565.5858.

All yardage requirements are noted for each model number and option, refer to the pricing charts in this book. All yardage requirements shown in our price list are based on 54" plain material. Fabrics which have a repeat that must be matched, or are less than 54" wide, will require more yardage. Check with Customer Service before ordering. There may be yardage savings for quantity orders of the same model. Check with Customer Service before ordering. ALL COM WILL BE CUT AND APPLIED AT OUR DISCRETION UNLESS SPECIAL CUTTING INSTRUCTIONS ARE INCLUDED IN WRITING WITH THE ORDER. FABRIC PATTERNS SHOULD BE IDENTIFIED AS APPLIED VERTICALLY OR HORIZONTALLY ON A FRAME. WE CANNOT BE HELD RESPONSIBLE FOR RECEIPT OF DEFECTIVE FABRIC AS WE APPLY ALL COM AS FIRST QUALITY GOODS.

Fabric	Plain	2" - 14"	15" - 24"	25" - 27"	28" - 36"
Width	Fabric	Repeat	Repeat	Repeat	Repeat
54"	0%	10%	15%	20%	25%
50"	10%	20%	25%	30%	35%
48"	15%	25%	30%	35%	40%
45"	40%	50%	55%	60%	65%
36"	50%	60%	65%	70%	75%

We cannot be held responsible if yardage supplied is insufficient to complete an order.

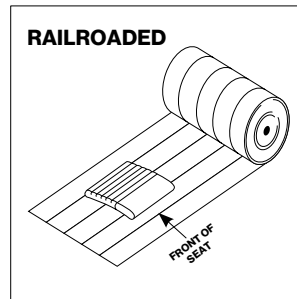
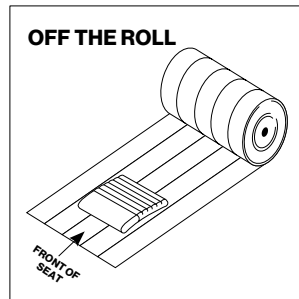

CUSTOMER'S OWN LEATHER:

All furniture listed in this price list that is available with leather has pricing in COL, refer to the COL column throughout this book. Leather is applied to avoid scars, however, some markings are inherent in this natural material. Square footage requirements are based on cow hides measuring 50 sq.ft. per hide. Consult Nienkämper's Customer Service Department for square footage requirements before ordering when using hides that do not meet these requirements. Application instructions must accompany all COL orders. In the absence of these instructions Nienkämper will determine the best method of upholstery.

SHIPPING YOUR MATERIALS:

For Canada
Customer supplied material must be sent prepaid to:

Nienkämper International, Inc.
257 Finchdene Square
Toronto, Ontario
Canada M1X 1B9

From all locations outside of Canada
Customer supplied material must be sent prepaid to:

Livingston International
c/o Nienkämper
257 Finchdene Square
Toronto, Ontario
Canada M1X 1B9

All packages must include a copy of a commercial invoice showing the exact yardage, value and fibre content of the fabric and must indicate our order confirmation number, or customer's purchase order number, and the furniture for which it is intended.

UPHOLSTERY DETAILS

An index of KnollTextiles fabric follows. Contact KnollTextiles customer service at 1.800.237.1625 for an updated listing. For fabric not graded in, please contact customer service for pricing.

ALPHABETICAL INDEX:

CATEGORY 1			
Attire	K2340	Oh La La	K2201
Axiom*	K1650	On Point*	K2293
Bistro	K1775	Overture	K2169
Bocce	K1255	Palisade*	K2030
Boundary*	K1828	Patchwork*	K2292
Brigadoon*	K2167	Petal Pusher*	K1968
Calypso	K2127	Prairie*	K1925
Chain Link*	K2191	Prep*	K1076
Chameleon*	K2372	Presto	K1000
Chance	K1552	Prim*	K1884
Code	K2251	Pullman	K2124
Color Field*	K2226	Ransom	K1298
Commuter Cloth	K1778	Retreat*	K2367
Cross Tech	K2279	Roam	K1657
Crossroad	K2085	Rush Hour	K1824
Day Tripper	K2248	Sashiko	K2121
Delite	K2026	Soliloquy	K1458
Diva	K2051	Sonnet	K1460
Dottie	K2259	Spree	K1600
Dune*	K2047	Stripemania*	K2225
Entwine	K2355	Summit	K2020
Essence*	K2059	Sutton	K1750
Ferry	K1697	Synth	K1693
Gala II*	K1520	Tabloid	K2022
Greenwich*	K1753	Tight Rope*	K1798
Groovy*	K2242	Tilden*	K1779
Helios	K2089	Tinge*	K2068
Holbrook	K1928	Topos*	K2397
Hourglass	K1523	Trophy	K1709
Infinite	K2263	Uni-Form	K2125
Instinct	K2258	Utopia*	K2371
Journey	K1806	Venue	K1558
Kaya CR	K2122	Versa	K1698
Keaton	K1596	Vibe II*	K2154
Knoll Felt	K1207	Vinyl	K242
Knoll Hopsack	K1206	Westwood*	K1949
Little Devil	K2112	Wild Thing*	K2240
Ludlow	K1998	Wit*	K2050
Magnolia*	K1999	Yeni	K2082
Melody*	K2067	Zen Wave	K2078
Monarch	K1149		

CATEGORY 2			
Abacus	K715	Kimono	K1174
Aegean	K2074	Lagos*	K2028
Alter Ego	K2140	Liberty	K1888
Arrondissement	K2200	Lore CR	HC1123
Atlas*	K1236	Marquee	K1608
Belize*	K1165	Melange	K1882
Biscayne	K1771	Menagerie	K1322
Buzz	K2373	Meroe	K2043
Cairo	K2034	Midpoint	K2123
Cameo	K1443	Milestone*	K1886
Charm	K1049	Mod Plaid	K1630
Chronicle	K1525	Modern Tweed	K2155
Circa	K1054	Nature Walk*	K2081
Classic Boucle	K162	Origins	K1700
Cleo	K2168	Paradigm	K1101
Color Collage	K2349	Plaidtastic*	K2238
Dapper	K2338	Premier*	K2294
Demure LUXE	K2023	Quark	K781
Djenne	K2029	Radiance	K1921
Double Agent	K2199	Rebel	K2261
Dristi	K872	Sahara	HC1269
Durand*	K1885	Seurat	K2151
Eclat Weave	K1104	Sherman	K1789
Fancy Twill	K2348	Shima	K1468
Feeling Plaid	K2150	Sideline*	K2210
Glider	K1717	Sinclair*	K1555
Grandview*	K1463	Smart	K1268
Highland	K2010	Spot On	K1324
Hudson*	K1765	Stepping Stones	K346
Ikat Square	K1703	Swank LUXE	K2221
Ikat Stripe	K1701	Swing	K479
Imprint	K2333	Tempest	K2377
In Stitches	K2190	Totem	K1561
Island*	K2053	Utmost II	K2358
It's Complicated*	K2252	Vatera	K2071
Juno	K2152	Vice Versa*	K2361
Kabuki	K2084	Whip*	K1386
Kampala	K2032	Woodland*	K2049
Katazome	K1459	Zari CR	HC1008

* Fabric with "*" is Bleach Cleanable

UPHOLSTERY DETAILS

An index of KnollTextiles follows. Contact KnollTextiles customer service at 1.800.237.1625 for an updated listing. For fabric not graded in, please contact customer service for pricing.

ALPHABETICAL INDEX:

CATEGORY 3	
All Star LUXE	K2209
Amore LUXE	K2080
Andissa	K2083
Arezzo LUXE	K1442
Aswan	K2046
Atelier	K1607
Calais Cotton Velvet	K787
Catwalk	K2156
Chiseled	K2249
Doyenne LUXE	K2353
Floressence	K2357
Haze	K109
In Step	K2375
Jasmine LUXE	K2077
Kamani LUXE	K1580
Petite Floral LUXE	K2087
Rivington	K1080
Stretch Appeal	K2188
Striae Stripe	K1827
Stripe It*	K2368
Tara LUXE	K1967
Tivoli LUXE	K2063
Tryst	K1522
Twist Tie	K2264
Ultrasuede	K1021
Utrillo	K1807
World Piece	K2208

CATEGORY 4	
Bavaria LUXE	K1160
Chic LUXE	K2351
Constance LUXE	K1527
Cummings LUXE	K1378
Diamond Days LUXE	K1756
Duchess LUXE	K1209
Dynamic	K1617
Gibson	K1086
Hastings LUXE	K1087
Knoll Velvet	K784
Olema LUXE	K1764
Piper LUXE	K1706
Prince Hairy LUXE	K2237
Rutledge LUXE	K1707
Spencer	K1106
Tudor LUXE	K1579
Zimba LUXE	K1669

* Fabric with "***" is Bleach Cleanable

UPHOLSTERY DETAILS (CONTINUED)

An index of KnollTextiles follows. Contact KnollTextiles customer service at 1.800.237.1625 for an updated listing. For fabric not graded in, please contact customer service for pricing.

NUMERICAL INDEX:

CATEGORY 1			
Vinyl	K242	Palisade*	K2030
Presto	K1000	Dune*	K2047
Prep*	K1076	Wit*	K2050
Monarch	K1149	Diva	K2051
Knoll Hopsack	K1206	Essence*	K2059
Knoll Felt	K1207	Melody*	K2067
Bocce	K1255	Tinge*	K2068
Ransom	K1298	Zen Wave	K2078
Soliloquy	K1458	Yeni	K2082
Sonnet	K1460	Crossroad	K2085
Gala II*	K1520	Helios	K2089
Hourglass	K1523	Little Devil	K2112
Chance	K1552	Sashiko	K2121
Venue	K1558	Kaya CR	K2122
Keaton	K1596	Pullman	K2124
Spree	K1600	Uni-Form	K2125
Axiom*	K1650	Calypso	K2127
Roam	K1657	Vibe II*	K2154
Synth	K1693	Brigadoon*	K2167
Ferry	K1697	Overture	K2169
Versa	K1698	Chain Link*	K2191
Trophy	K1709	Oh La La	K2201
Sutton	K1750	Stripemania*	K2225
Greenwich*	K1753	Color Field*	K2226
Bistro	K1775	Wild Thing*	K2240
Commuter Cloth	K1778	Groovy*	K2242
Tilden*	K1779	Day Tripper	K2248
Tight Rope*	K1798	Code	K2251
Journey	K1806	Instinct	K2258
Rush Hour	K1824	Dottie	K2259
Boundary*	K1828	Infinite	K2263
Prim*	K1884	Cross Tech	K2279
Prairie*	K1925	Patchwork*	K2292
Holbrook	K1928	On Point*	K2293
Westwood*	K1949	Attire	K2340
Petal Pusher*	K1968	Entwine	K2355
Ludlow	K1998	Retreat*	K2367
Magnolia*	K1999	Utopia*	K2371
Summit	K2020	Chameleon*	K2372
Tabloid	K2022	Topos*	K2397
Delite	K2026		

CATEGORY 2			
Zari CR	HC1008	Liberty	K1888
Lore CR	HC1123	Radiance	K1921
Sahara	HC1269	Highland	K2010
Stepping Stones	K346	Demure LUXE	K2023
Swing	K479	Lagos*	K2028
Abacus	K715	Djenne	K2029
Quark	K781	Kampala	K2032
Dristi	K872	Cairo	K2034
Charm	K1049	Meroe	K2043
Circa	K1054	Woodland*	K2049
Paradigm	K1101	Island*	K2053
Eclat Weave	K1104	Vatera	K2071
Belize*	K1165	Aegean	K2074
Kimono	K1174	Nature Walk*	K2081
Atlas*	K1236	Kabuki	K2084
Smart	K1268	Midpoint	K2123
Menagerie	K1322	Alter Ego	K2140
Spot On	K1324	Feeling Plaid	K2150
Whip*	K1386	Seurat	K2151
Cameo	K1443	Juno	K2152
Katazome	K1459	Modern Tweed	K2155
Grandview*	K1463	Cleo	K2168
Shima	K1468	In Stitches	K2190
Chronicle	K1525	Double Agent	K2199
Sinclair*	K1555	Arrondissement	K2200
Totem	K1561	Sideline*	K2210
Marquee	K1608	Swank LUXE	K2221
Classic Boucle	K162	Plaidtastic*	K2238
Mod Plaid	K1630	It's Complicated*	K2252
Origins	K1700	Rebel	K2261
Ikat Stripe	K1701	Premier*	K2294
Ikat Square	K1703	Imprint	K2333
Glider	K1717	Dapper	K2338
Hudson*	K1765	Fancy Twill	K2348
Biscayne	K1771	Color Collage	K2349
Sherman	K1789	Utmost II	K2358
Melange	K1882	Vice Versa*	K2361
Durand*	K1885	Buzz	K2373
Milestone*	K1886	Tempest	K2377

* Fabric with "*" is Bleach Cleanable

UPHOLSTERY DETAILS (CONTINUED)

An index of KnollTextiles follows. Contact KnollTextiles customer service at 1.800.237.1625 for an updated listing. For fabric not graded in, please contact customer service for pricing.

NUMERICAL INDEX:

CATEGORY 3	
Haze	K109
Calais Cotton Velvet	K787
Ultrasuede	K1021
Rivington	K1080
Arezzo LUXE	K1442
Tryst	K1522
Kamani LUXE	K1580
Atelier	K1607
Utrillo	K1807
Striae Stripe	K1827
Tara LUXE	K1967
Aswan	K2046
Tivoli LUXE	K2063
Jasmine LUXE	K2077
Amore LUXE	K2080
Andissa	K2083
Petite Floral LUXE	K2087
Catwalk	K2156
Stretch Appeal	K2188
World Piece	K2208
All Star LUXE	K2209
Chiseled	K2249
Twist Tie	K2264
Doyenne LUXE	K2353
Floressence	K2357
Stripe It*	K2368
In Step	K2375

CATEGORY 4	
Knoll Velvet	K784
Gibson	K1086
Hastings LUXE	K1087
Spencer	K1106
Bavaria LUXE	K1160
Duchess LUXE	K1209
Cummings LUXE	K1378
Constance LUXE	K1527
Tudor LUXE	K1579
Dynamic	K1617
Zimba LUXE	K1669
Piper LUXE	K1706
Rutledge LUXE	K1707
Diamond Days LUXE	K1756
Olema LUXE	K1764
Prince Hairy LUXE	K2237
Chic LUXE	K2351

* Fabric with "*" is Bleach Cleanable

CALIFORNIA TECHNICAL BULLETIN 133

All chairs utilize California Bulletin 117 approved fire retardant, CFC-free polyurethane foam.

California 133 - Nienkämper seating designs can be manufactured to meet California Technical Bulletin 133. Certification applies to Nienkämper leathers and fabrics that have a minimum 50% natural fibre content. COM/COL's must be evaluated on an individual basis which may require testing of fabric on the furniture. Testing may require additional cost and lead time.

-Cost of testing a chair is \$750 NET, plus cost of product.

-Additional lead time for testing is 6 weeks.

-See individual product pages for seating that has been tested, applicable upcharge for CAL 133 stated on product page.

Boston Fire Code - Boston has adopted California 133 standards. All information pertaining to California Technical Bulletin 133 as stated above satisfies the Boston Fire Code.

CAL 133 Available	Page
Office Seating:	
Nabu™ Office Chair	21-22
Nienkämper NOW®	25
Senator® Boardroom	32
Senator® CEO	33
Senator® Executive	35
Side Chairs:	
Nabu™ Side Chair	47-48
Lounge Seating:	
Baden/Zurich	57-58
Berkley® Collection	64-67
Carlisle	73
Cocoon	74
Eden	77-92
Kloud Collection	102
Max™	108-113
Satori™	126
Six® Collection	127
Spirit	128
Tuxedo™	130
Tuxedo™ Classic	132-135
Tuxedo™ High Back	140
Wavelength®	143-144
Benches:	
Blottoman	151
Elevation Bench	154
Max™ Benches	159
Six® Bench	166
Wavelength® Bench	168

Note: Add the extension "-CAL" at the end of each model number for each chair ordered as CAL 133 certified. For example, a Senator Executive, low back chair on casters with urethane arm, CAL 133 certified would be Model # 14111-CAL.

VENEERS

All wood surfaces are protected with a durable polyurethane clear laquer with UV inhibitor. This finish is known for its exceptional durability, as well as abrasion, chemical, impact and scratch resistance. Standard sheen level is 45 degrees. Optional 10 and 35 degree sheen levels are available on request at no additional cost.

Wood Species	Order Code	Veneer/Stain	Upcharge
Maple	F-01	Natural Maple	No upcharge applies.
	F-02	Natural Curly Maple - Rotary Cut	Add 15%.
	F-03	Natural Bird's Eye Maple - Rotary Cut	Call Customer Service for pricing.
	F-04	Maple Stained Pear	No upcharge applies.
Cherry	F-05	Natural Cherry	No upcharge applies.
	F-06	Standard Cherry	No upcharge applies.
	F-07	Cherry Stained Amber	No upcharge applies.
	F-08	Cherry Stained Auburn	No upcharge applies.
	F-09	Cherry Stained Burgundy	No upcharge applies.
Mahogany	F-10	Light Mahogany	No upcharge applies.
	F-11	Medium Mahogany	No upcharge applies.
	F-12	Dark Mahogany	No upcharge applies.
	F-13	Red Mahogany	No upcharge applies.
Anagre	F-14	Natural Figured Anagre - Qtr. Cut Book-Match	Add 15%.
	F-15	Figured Anagre Stained Amber - Qtr. Cut Book-Match	Add 15%.
Sycamore	F-16	Natural Figured Sycamore - Qtr. Cut Book-Match	Add 15%.
Walnut	F-17	Burnt Walnut	No upcharge applies.
	F-19	Natural Walnut	No upcharge applies.
	F-24	Carbon Grey Walnut	No upcharge applies.
White Oak	F-18	Natural White Oak - Flat Cut Book-Match (10° sheen)	No upcharge applies.
		Natural White Oak - Rift Cut Slip-Match (10° sheen)	Add 5%
Sapele – Ribbon Stripe	F-20	Natural Ribbon Strip Sepele - Qtr. Cut Slip-Match	No upcharge applies.
Moabe (Cherry substitute)	F-21	Natural Moabe - Quarter - Qtr. Cut Book-Match	No upcharge applies.
Cape Coast Walnut	F-22	Dark Cape Coast Walnut - Qtr. Cut Slip-Match	No upcharge applies.
	F-23	Natural Cape Coast Walnut - Qtr. Cut Slip-Match	No upcharge applies.
Ash	F-25	Slate Grey Ash - Qtr. Cut Slip-Match	No upcharge applies.

VENEER GRAIN OPTIONS

Nienkamper products utilize the best quality veneers available, and, combined with Nienkämper's patented veneering systems, create work environments of incredible quality and beauty.

All veneer furniture comes standard with flat cut book-match veneer; flat cut slip-match veneer can also be specified. Quarter cut slip-match and quarter cut book-match veneers are available at a 5% upcharge. Figured Anagre and Figured Sycamore veneers are Quarter cut book-matched. Bird's Eye Maple and Curly Maple are rotary cut.

Facet Edge, Taper edge and Flowform edge tops with veneer are manufactured with a solid wood edge. All edges are then veneer wrapped to create a seamless profile top.

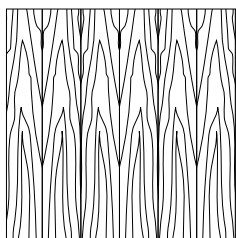

Standard Flat Cut Book-Match V1

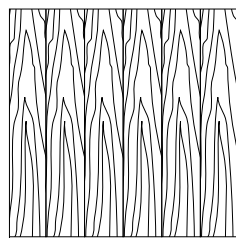

Flat Cut Slip-Match V2

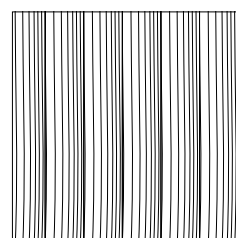

Quarter Cut Slip-Match Add 5% V3

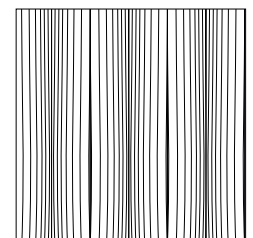

Quarter Cut Book-Match Add 5% V4

nienkämper

International Inc.

OFFICE SEATING



OFFICE SEATING

TABLE OF CONTENTS

Office Seating	13-42
Rush Ship	15-16
AYA™	17
Emissary	18
Ingmar Conference	19
Kris	20
Nabu™	21-23
Nienkämper NOW®	24-30
Senator® Boardroom	32
Senator® CEO	33
Senator® Classic	34
Senator® Executive	35
Senator Mesh Back	36
Senator® Nuvo Office	37
Senit Chair	38
Shaker	39
Slim	40
Trench	41
Vuelo	42

Need chairs fast? 10 day delivery.

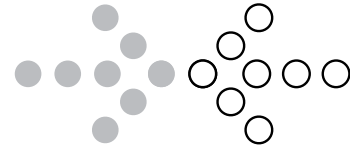

Model 10932



Model 10602

Within 10 business days from receipt of order, Nienkämper will deliver, 1 to 20:

- #14659 Senator Boardroom chair, upholstered in Verde Black leather, medium back, urethane arms with wrap.
- #14122 Senator Executive chair, medium back, urethane arms with cap, upholstered in Verde Black leather, black pneumatic base.
- #13022 Nienkämper NOW[®] Chair, upholstered in Verde black leather, polished arm supports, polished aluminum base, chrome casters.
- #13024 Nienkämper NOW[®] Chair, upholstered in Verde black leather, black base, black casters.
- #13060 Nienkämper NOW[®] Chair, upholstered in Verde black leather, multifunctional armrests, polished aluminum base, chrome casters.
- #10602 Nabu™ Chair with black (7209-BE) striped mesh back and seat, black base, cantilever arms.

Contact your representative to place your Rush Ship order. Effective January 1, 2020.

To Rush Ship call: **800.668.9318**

In Toronto call: **416.298.5700**

Need chairs fast? 10 day delivery.

To Rush Ship call: **800 668 9318**

In Toronto call: **416 298 5700**



Nienkämper NOW® Medium Back
Model 13022, 13024 or 13060



Senator® Boardroom Medium Back
Model 14659



Senator® Executive Medium Back
Model 14122



Nabu™
Model 10602

Nienkämper
Corporate Office
Contract Showroom & Factory

257 Finchdene Square
Toronto, Ontario
Canada M1X 1B9
www.nienkamper.com

Tel 800.668.9318
Tel 416.298.5700
Fax 416.298.9535
mail@nienkamper.com

OFFICE SEATING

AYA™ Designer - Mark Saffel and David Ritch

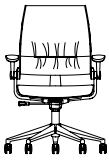
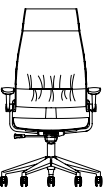
Model Number	Seat H"	Arm		D"	H"	Fabric Yds.	Leather Sq.Ft.	COM	COL	Verde	Grano	Cremoso	— CDN Only — KnollTextiles			
		H"	W"										1	2	3	4
MEDIUM BACK																
	13301 Black Base															
	18-21	24-27	26½	26	36-39	1¼	28	2,335	2,455	3,105	3,355	3,445	2,575	2,810	3,080	3,340
	13302 Polished Aluminum with Black Casters															
	18-21	24-27	26½	26	36-39	1¼	28	2,460	2,585	3,240	3,485	3,565	2,705	2,940	3,210	3,475
	13305 Polished Aluminum with Chrome Casters															
	18-21	24-27	26½	26	36-39	1¼	28	2,485	2,605	3,265	3,505	3,590	2,725	2,965	3,235	3,495
HIGH BACK																
	13303 Black Base															
	18-21	24-27	26½	26	45-48	2	34	2,940	3,080	3,885	4,185	4,280	3,220	3,495	3,800	4,095
	13304 Polished Aluminum with Black Casters															
	18-21	24-27	26½	26	45-48	2	34	3,070	3,200	4,015	4,320	4,405	3,345	3,620	3,920	4,225
	13306 Polished Aluminum with Chrome Casters															
	18-21	24-27	26½	26	45-48	2	34	3,090	3,240	4,040	4,340	4,440	3,370	3,640	3,940	4,245

Model # 13305
Medium Back



The ultimate in ergonomic elegance, the AYA™ Chair is based on the principles of natural body motion when reclining. The simplicity of function uses the occupant's own weight to control the seating position. As you recline and stop, the chair will stay in that position. There is no tension control, as the weight of the occupant rides up a ten degree incline, using gravity as the resistance and friction as the position control. There is only one control on the chair which adjusts height and locks the seat in one of five positions.

OFFICE SEATING

Emissary Chair Designer – Aaron duke

Model Number	Seat H"	Arm H"	W"	D"	H"	Fabric Yds.	Leather Sq.Ft.	— CDN Only — KnollTextiles							
								COM	COL	Neather	Verde	Grano	Cremoso	1	2

EMISSARY LOW BACK



10061	18½-21	25-28	25	24	39-42	1¾	32	2,395	2,520	2,575	3,385	3,565	3,660	2,640	2,885	3,145	3,405
--------------	--------	-------	----	----	-------	----	----	-------	-------	-------	-------	-------	-------	-------	-------	-------	-------

EMISSARY MEDIUM BACK



10062	18½-21½	25-28	25	24	44-47	2	36	2,405	2,535	2,610	3,505	3,705	3,810	2,690	2,960	3,265	3,560
--------------	---------	-------	----	----	-------	---	----	-------	-------	-------	-------	-------	-------	-------	-------	-------	-------

EMISSARY HIGH BACK



10063	18½-21½	25-28	25	24	49-52	2¼	41	2,430	2,560	2,650	3,670	3,895	4,010	2,745	3,055	3,390	3,725
--------------	---------	-------	----	----	-------	----	----	-------	-------	-------	-------	-------	-------	-------	-------	-------	-------

Standard Features

- Soy based rigid polyurethane inner shell
- Over moulded with soy based flexible polyurethane foam
- Pneumatic height adjustment
- Back tilt locking mechanism
- Carpet casters
- Black five-star base & casters
- Leather upholstered arm cap
- For chair with COM & KnollTextiles upholstery finish, leather upholstered arm cap is available in Nienkämper Verde/Grano/Cremoso leather

Optional Features

- Hard floor casters, add \$100 list per chair
- Glides, add \$100 list per chair
- Polished aluminum five-star base with chrome casters, add \$65 list

Model # 10063

Emissary high back chair fully upholstered in Cremoso leather, black CM795 with polished chrome base



OFFICE SEATING

Ingmar Chair with Swivel Base Designer – Nienkämper

Model Number	Seat H"	Arm		D"	H"	Fabric		COM	COL	Verde	Grano	Cremoso	— CDN Only — Knoll Textiles			
		H"	W"			Yds.	Sq.Ft.						1	2	3	4

INGMAR CHAIR WITH CHANNEL SLING



13904	19½	26	23	24	40	1½	18	3,375	3,545	4,035	4,140	4,185	3,585	3,790	4,020	4,240
--------------	-----	----	----	----	----	----	----	-------	-------	-------	-------	-------	-------	-------	-------	-------

INGMAR CHAIR WITH SADDLE LEATHER SLING



13905	19½	26	23	24	40	1½	18	specify Brown (IVT05) or Black (IVT06)								
								3,810								

INGMAR CHAIR WITH MESH SLING



13906	19½	26	23	24	40	1½	18	specify Black (IM01), Racing Green (IM02), or Beige (IM03)								
								2,940								

Standard Features



- natural cherry, maple or walnut frame
- stained to match available: wood finish available in standard Nienkämper
- stains; to match custom stain add \$570 list per each stain colour
- channel sling available in fabrics and leathers
- saddle leather sling available in Brown (IVT05) or Black (IVT06)
- mesh sling available in Black (IM01), Racing Green (IM02) or Beige (IM03)
- chrome base and chrome casters

Model # 13904
Ingmar with channel sling



OFFICE SEATING

Kris Conference Chair Designer – BangDesign

Model Number	Seat H"	Arm H"	W"	D"	H"	Fabric Yds.	Leather Sq.Ft.	COM	COL	Neather	Verde	Grano	Cremoso	— CDN Only — Knoll Textiles			
														1	2	3	4
MEDIUM BACK																	
11461	19-22	24-27	26	27	40½-43½	3½	32	2,485	2,605	2,795	3,355	3,660	3,735	2,940	3,400	3,905	4,395
																	
HIGH BACK																	
11462	19-22	24-27	26	27	49-52	3½	40	2,885	3,020	3,235	3,960	4,335	4,450	3,385	3,895	4,445	4,990
																	
UPHOLSTERED ARM CAPS																	
						½	2	90	95	140	140	155	160	165	240	305	380

Standard Features

- Polished Aluminum base with black painted underside
- Frames are molded plywood
- Cushions are molded foam with 25 percent soy foam content
- Black polyurethane arm caps with brushed underside
- Upholstered arm caps an option
- Powder coat arms available upon request
- Black casters

Model # 11461
Kris Medium Back





Model # 11462
Kris High Back



OFFICE SEATING

Nabu™ Chair – striped mesh back Designer – BangDesign

														— CDN Only —										
Model Number	Seat H"	Arm H"	W"	D"	H"	Fabric Yds.	Leather Sq.Ft.	COM	COL	Neather	Verde	Grano	Cremoso	KnollTextiles										
														1	2	3	4							
NABU™ CHAIR WITH CANTILEVER ARMS																								
	10601	17½-21	25½-29	23½	25½	35-38½	¾	9	upholstered seat with striped mesh back						1,165	1,205	1,215	1,350	1,400	1,450	1,270	1,375	1,485	1,595
							mesh seat with striped mesh back						1,135											
NABU™ CHAIR WITH ADJUSTABLE ARMS																								
	10609	17½-21	24½-28	24½	25½	35-38½	¾	9	upholstered seat with striped mesh back						1,190	1,235	1,250	1,375	1,435	1,480	1,295	1,400	1,510	1,620
							mesh seat with striped mesh back						1,165											
NABU™ CHAIR ARMLESS																								
	10603	17½-21		20	25½	35-38½	¾	9	upholstered seat with striped mesh back						1,075	1,105	1,130	1,275	1,310	1,360	1,185	1,285	1,400	1,505
							mesh seat with striped mesh back						1,055											

Nabu™ Chairs (striped mesh back) are available as CAL 133 certified for an upcharge of \$125 list per chair. Certification applies to Nienkämper leathers and fabrics that have a minimum of 50% natural fibre content. COM's and COL's are subject to approval. Add the extension "-CAL" to the model number when ordering.

NOTE:

• Teller Stool (height: 43" - 53") add "T" at the end of model # with an upcharge of \$200 list per chair.

Standard features:

- Seat available in 29 solid mesh colors. Back available in 34 contrasting mesh stripe. Back mesh has a horizontal stripe pattern as standard created by the strong elastomer fiber woven in the mesh.
- Cushions are molded foam with 25% soy foam content
- Spring loaded pivot action provides a rocking motion 6 degrees back and 3 degrees forward.
- Knee tilt action with tension control and 4 position back lock available for an upcharge of \$85 list
- Swivel base is black as standard; add \$70.00 list for polished aluminum with chrome casters
- Tubular steel leg or sled base is standard silver powder coat
- Back frame and arms are black as standard.
- Models 10605 through 10608 are stachable - 6 high on floor and 10 high on dolly. Footprint 23" wide x 32" deep.
- Dolly priced separately.

Model # 10601



Model # 10609



Model # 10603









Model # 10602T



OFFICE SEATING

Nabu™ Chair – fully upholstered back Designer – BangDesign

										— CDN Only —									
										KnollTextiles									
Model Number	Seat H"	Arm H"	W"	D"	H"	Fabric Yds.	Leather Sq. Ft.	COM	COL	Neather	Verde	Grano	Cremoso	1	2	3	4		
NABU™ CHAIR WITH CANTILEVER ARMS																			
										fully upholstered seat and back									
	10611	17½-21	25½-29	23½	25½	35-38½	1½	24		1,415	1,470	1,485	1,615	1,665	1,710	1,625	1,830	2,055	2,275
										mesh seat with fully upholstered back									
	10612	17½-21	25½-29	23½	25½	35-38½	¾	9		1,450	1,490	1,460	1,585	1,615	1,640	1,560	1,655	1,775	1,875
NABU™ CHAIR WITH ADJUSTABLE ARMS																			
										fully upholstered seat and back									
	10619	17½-21	24½-28	24½	25½	35-38½	1½	24		1,455	1,495	1,505	1,640	1,695	1,735	1,665	1,865	2,095	2,320
										mesh seat with fully upholstered back									
	10620	17½-21	24½-28	24½	25½	35-38½	¾	9		1,480	1,525	1,490	1,615	1,645	1,680	1,590	1,690	1,805	1,915
NABU™ CHAIR ARMLESS																			
										fully upholstered seat and back									
	10613	17½-21		20	25½	35-38½	1½	24		1,340	1,375	1,400	1,535	1,585	1,630	1,545	1,750	1,975	2,195
										mesh seat with fully upholstered back									
	10614	17½-21		20	25½	35-38½	¾	9		1,360	1,400	1,375	1,505	1,535	1,575	1,465	1,570	1,680	1,795

Nabu™ Chairs (fully upholstered back) are available as CAL 133 certified for an upcharge of \$125 list per chair. Certification applies to Nienkämper leathers and fabrics that have a minimum of 50% natural fibre content. COM's and COL's are subject to approval. Add the extension "-CAL" to the model number when ordering.

NOTE:

- Teller Stool (height: 43" - 53") add "T" at the end of model # with an upcharge of \$200 list per chair.

Standard features:



- Seat available in 29 solid mesh colors. Back available in 34 contrasting mesh stripe. Back mesh has a horizontal stripe pattern as standard created by the strong elastomer fiber woven in the mesh.
- Cushions are molded foam with 25% soy foam content
- Spring loaded pivot action provides a rocking motion 6 degrees back and 3 degrees forward.
- Knee tilt action with tension control and 4 position back lock available for an upcharge of \$85 list
- Swivel base is black as standard; add \$70.00 list for polished aluminum with chrome casters
- Tubular steel leg or sled base is standard silver powder coat
- Back frame and arms are black as standard.
- Models 10605 through 10608 are stachable - 6 high on floor and 10 high on dolly. Footprint 23" wide x 32" deep.
- Dolly priced separately.

Model # 10611



OFFICE SEATING

Nabu™ Chair – fully upholstered mesh back Designer – BangDesign

Model Number	Seat H"	Arm H"	W"	D"	H"	Fabric Yds.	Leather Sq.Ft.	COM	COL	Neather	Verde	Grano	Cremoso	— CDN Only — KNOLL TEXTILES										
														1	2	3	4							
<u>NABU™ CHAIR WITH CANTILEVER ARMS</u>																								
	10621	17½-21	25½-29	23½	25½	35-38½	¾	9	upholstered seat with fully upholstered mesh back						1,200	1,245	1,255	1,385	1,445	1,485	1,305	1,410	1,525	1,630
	mesh seat with fully upholstered mesh back															1,215								
<u>NABU™ CHAIR WITH ADJUSTABLE ARMS</u>																								
	10629	17½-21	24½-28	24½	25½	35-38½	¾	9	upholstered seat with fully upholstered mesh back						1,230	1,275	1,285	1,385	1,470	1,505	1,340	1,435	1,555	1,655
	mesh seat with fully upholstered mesh back															1,250								
<u>NABU™ CHAIR ARMLESS</u>																								
	10623	17½-21		20	25½	35-38½	¾	9	upholstered seat with fully upholstered mesh back						1,105	1,150	1,175	1,305	1,355	1,400	1,215	1,315	1,430	1,540
	mesh seat with fully upholstered mesh back															1,130								

NOTE:

- Teller Stool (height: 43" - 53") add "T" at the end of model # with an upcharge of \$200 list per chair.

Standard features:

- Seat available in 29 solid mesh colors. Back available in 34 contrasting mesh stripe. Back mesh has a horizontal stripe pattern as standard created by the strong elastomer fiber woven in the mesh.
- Cushions are molded foam with 25% soy foam content
- Spring loaded pivot action provides a rocking motion 6 degrees back and 3 degrees forward.
- Knee tilt action with tension control and 4 position back lock available for an upcharge of \$85 list
- Swivel base is black as standard; add \$70.00 list for polished aluminum with chrome casters
- Tubular steel leg or sled base is standard silver powder coat
- Back frame and arms are black as standard.
- Models 10605 through 10608 are stachable - 6 high on floor and 10 high on dolly. Footprint 23" wide x 32" deep.
- Dolly priced separately.

Model # 10629



OFFICE SEATING

Nienkämper NOW® Chair Designer - Mark Müller



Fixed Aluminum Arm Supports – Polished Finish
(Available in Black Paint)



Multifunctional Armrest

Multifunctional Arm Adjustments



Depth Adjustment
• 5 Positions
• 2" Range of Motion



Height Adjustment
• 12 Positions
• 4 3/8" Range of Motion



Swivel Adjustment
• Left Swivel = 15°
• Right Swivel = 15°



Width Adjustment
• 3 Positions
• Interior Arm Clearance= 18 1/2" to 20 3/4" (Can be increased up to 20 1/2" to 22 3/4")



Black Glides (Plastic)
Available with Self-Return Base



Chrome Glides
Available with Self-Return Base















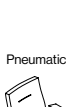

75mm Black Plastic Casters
Also available with soft-wheel



75mm Casters
(Chrome Centre Strip)
Also available with soft wheel, or
Electrical Static Discharge version

OFFICE SEATING

Nienkämper NOW® Chair Designer - Mark Müller

Model Number	Seat H"	Arm H"	W"	D"	H"	Fabric Yds.	Leather Sq. Ft.	COM	COL	— CDN Only — KnollTextiles						
										Neather	Verde	Grano Cremoso	1	2	3	4
FULLY UPHOLSTERED																
Pneumatic Height Adjustment on Casters																
	13050	Black Painted Arm Supports, Black Plastic Base, Black Casters														
	18-21	24½-27½	26	25	36½-39½	1¼	28	1,565	1,600	1,735	2,330	2,575	2,675	1,810	2,045	2,310
	13052	Black Painted Arm Supports, Polished Alum. Base, Chrome Casters														
	18-21	24½-27½	26	25	36½-39½	1¼	28	1,745	1,785	2,075	2,505	2,760	2,855	1,985	2,230	2,495
	13024	Polished Arm Supports, Black Plastic Base, Black Casters														
	18-21	24½-27½	26	25	36½-39½	1¼	28	1,635	1,675	1,810	2,395	2,645	2,730	1,875	2,125	2,385
	13022	Polished Arm Supports, Polished Alum. Base, Chrome Casters														
	18-21	24½-27½	26	25	36½-39½	1¼	28	1,815	1,850	1,985	2,575	2,830	2,920	2,055	2,295	2,565
	13058	Multifunctional Armrests, Black Plastic Base, Black Casters														
	18-21	24½-27½	27½	25	36½-39½	1¼	28	1,565	1,600	1,740	2,330	2,575	2,675	1,810	2,045	2,310
	13060	Multifunctional Armrests, Polished Alum. Base, Chrome Casters														
	18-21	24½-27½	27½	25	36½-39½	1¼	28	1,745	1,785	1,925	2,505	2,760	2,855	1,985	2,230	2,495
Pneumatic Height Adjustment on Glides																
	13062	Black Painted Arm Supports, Black Plastic Base, Black Glides														
	18-21	24½-27½	26	25	36½-39½	1¼	28	1,525	1,555	1,695	2,275	2,530	2,615	1,765	2,010	2,270
	13064	Black Painted Arm Supports, Polished Alum. Base, Chrome Glides														
	18-21	24½-27½	26	25	36½-39½	1¼	28	1,665	1,705	1,830	2,415	2,680	2,770	1,915	2,150	2,410
	13028	Polished Arm Supports, Black Plastic Base, Black Glides														
	18-21	24½-27½	26	25	36½-39½	1¼	28	1,590	1,630	1,755	2,350	2,600	2,690	1,830	2,065	2,340
	13027	Polished Arm Supports, Polished Alum. Base, Chrome Glides														
	18-21	24½-27½	26	25	36½-39½	1¼	28	1,735	1,760	1,910	2,490	2,750	2,835	1,975	2,220	2,485
	13070	Multifunctional Armrests, Black Plastic Base, Black Glides														
	18-21	24½-27½	27½	25	36½-39½	1¼	28	1,525	1,555	1,695	2,275	2,530	2,615	1,765	2,010	2,270
	13072	Multifunctional Armrests, Polished Alum. Base, Chrome Glides														
	18-21	24½-27½	27½	25	36½-39½	1¼	28	1,665	1,705	1,840	2,415	2,680	2,770	1,915	2,150	2,410
Self-Return Jury Base with Pneumatic Height Adjustment																
	13074	Black Painted Arm Supports, Black Aluminum Jury Base														
	18-22	24½-27½	26	25	36½-40½	1¼	28	1,720	1,805	1,860	2,415	2,615	2,730	1,960	2,195	2,465
	13076	Polished Painted Arm Supports, Black Aluminum Jury Base														
	18-22	24½-27½	26	25	36½-40½	1¼	28	1,755	1,845	1,920	2,465	2,695	2,780	2,005	2,240	2,505
	13078	Multifunctional Armrest, Black Aluminum Jury Base														
	18-22	24½-27½	27½	25	36½-40½	1¼	28	1,730	1,810	1,865	2,415	2,670	2,755	1,970	2,205	2,480

Nienkämper NOW chair passes CAL 133 certified for an upcharge of \$305 list per chair. Certification applies to Nienkämper leathers and fabrics that have a minimum of 50% natural fibre content. COM's and COL's are subject to approval. Add the extension "-CAL" to the model number when ordering.

The Nienkämper NOW® Chair brings Nienkämper's renowned fine upholstery and contemporary aesthetics to the conference-room chair. Height, back and tilt controls, firm lumbar support and a contoured back ensure a comfortable, ergonomic sitting experience. Top stitching on the edges, a distinctive Y detail on the back and a tuck on the seat and back emphasize the chair's crisp, tailored elegance.

Standard Features:

- Locking tilt with return safety function
- Pneumatic height adjustment
- Synchronized seat-and-back recline
- Tilt tension control
- Top-stitch detail on seat and back covers
- Jury base for auditorium seating
- Large 75mm, unhooded, hard wheel casters (for soft flooring)
- Chrome (zinc) or black (plastic) glides
- 26" diameter five-star base

Suffix

- Optional Features:
- "A"** • Armless (remove painted arm supports) (deduct \$160 list)
 - "B"** • Verde/Terraverde, Grano/Carrillo or Cremoso/Tierno leather upholstered arm pads (for painted or polished arm supports) (add \$170 list)
- plus additional 3 sq.ft. of COL
 - "C"** • Verde/Terraverde, Grano/Carrillo or Cremoso/Tierno leather upholstered arm pads & panels (remove painted arm supports) (add \$515 list)
- plus additional 11 sq.ft. of COL
 - "D"** • Contrast stitching (leather covers only) (no upcharge)
 - "CAL"** • CAL 133 Certified applies to leather & fabric that has a minimum 50% natural fibre content. COM & COL subject to approval. (add \$305 list)

Caster Chair Options:

- "E"** • Soft wheel caster (for hard floors) Black (add \$80 list)
- "F"** • Soft wheel caster (for hard floors) Chrome (add \$60 list)
- "G"** • Hard wheel Electrical Static Discharge (ESD) caster (for soft flooring) Chrome (add \$105 list)
- "H"** • Fixed-height cylinder (no height adjustment, with swivel) (no upcharge)

Glide Chair Options:

- "I"** • Self-Return Base with Pneumatic Height Adjustment (add \$70 list)

OFFICE SEATING

Nienkämper NOW® Chair – Slim Profile Back Designer - Mark Müller

— CDN Only —

Model Number	Seat H"	Arm H"	W"	D"	H"	Fabric Yds.	Leather Sq. Ft.	COM	COL	Knoll Textiles			
										Neather	Verde	Grano	Cremoso

PILLOW BACK

Pneumatic Height Adjustment on Casters



13110 Black Painted Arm Supports, Black Plastic Base, Black Casters

18-21 24½-27½ 26 24 37½-40½ 1¼ 22

1,950 2,015 2,110 2,555 2,755 2,815 2,190 2,430 2,700 2,960

13112 Black Painted Arm Supports, Polished Alum. Base, Chrome Casters

18-21 24½-27½ 26 24 37½-40½ 1¼ 22

2,135 2,190 2,275 2,725 2,930 3,005 2,375 2,610 2,885 3,140

13114 Polished Arm Supports, Black Plastic Base, Black Casters

18-21 24½-27½ 26 24 37½-40½ 1¼ 22

2,020 2,075 2,175 2,610 2,815 2,890 2,260 2,500 2,770 3,025

13116 Polished Arm Supports, Polished Alum. Base, Chrome Casters

18-21 24½-27½ 26 24 37½-40½ 1¼ 22

2,195 2,260 2,350 2,795 3,005 3,070 2,445 2,685 2,950 3,210

13118 Multifunctional Armrests, Black Plastic Base, Black Casters

18-21 24½-27½ 27½ 24 37½-40½ 1¼ 10

1,950 2,015 2,110 2,555 2,755 2,815 2,190 2,430 2,700 2,960

13120 Multifunctional Armrests, Polished Alum. Base, Chrome Casters

18-21 24½-27½ 27½ 24 37½-40½ 1¼ 10

2,135 2,190 2,275 2,725 2,930 3,005 2,375 2,610 2,885 3,140

Pneumatic Height Adjustment on Glides



13122 Black Painted Arm Supports, Black Plastic Base, Black Glides

18-21 24½-27½ 26 24 37½-40½ 1¼ 22

1,915 1,965 2,050 2,495 2,700 2,775 2,155 2,390 2,665 2,920

13124 Black Painted Arm Supports, Polished Alum. Base, Chrome Glides

18-21 24½-27½ 26 24 37½-40½ 1¼ 22

2,045 2,115 2,195 2,645 2,855 2,920 2,290 2,530 2,795 3,060

13126 Polished Arm Supports, Black Plastic Base, Black Glides

18-21 24½-27½ 26 24 37½-40½ 1¼ 22

1,970 2,035 2,125 2,570 2,775 2,845 2,220 2,455 2,720 2,980

13128 Polished Arm Supports, Polished Alum. Base, Chrome Glides

18-21 24½-27½ 26 24 37½-40½ 1¼ 22

2,120 2,180 2,265 2,710 2,920 2,980 2,360 2,595 2,865 3,125

13130 Multifunctional Armrests, Black Plastic Base, Black Glides

18-21 24½-27½ 27½ 24 37½-40½ 1¼ 10

1,915 1,965 2,050 2,495 2,700 2,775 2,155 2,390 2,665 2,920

13132 Multifunctional Armrests, Polished Alum. Base, Chrome Glides

18-21 24½-27½ 27½ 24 37½-40½ 1¼ 10

2,045 2,115 2,195 2,645 2,855 2,920 2,290 2,530 2,795 3,060

Self-Return Jury Base with Pneumatic Height Adjustment



13134 Black Painted Arm Supports, Black Aluminum Jury Base

18-22 24½-28½ 26 24 37½-41½ 1¼ 22

2,070 2,175 2,230 2,780 3,015 3,100 2,320 2,560 2,820 3,085

13136 Polished Arm Supports, Black Aluminum Jury Base

18-22 24½-28½ 26 24 37½-41½ 1¼ 22

2,120 2,230 2,265 2,830 3,065 3,140 2,360 2,595 2,865 3,125

13138 Multifunctional Armrest, Black Aluminum Jury Base

18-22 24½-28½ 26 24 37½-41½ 1¼ 22

2,045 2,145 2,195 2,755 2,990 3,070 2,290 2,530 2,795 3,060

The Nienkämper NOW® Chair brings Nienkämper's renowned fine upholstery and contemporary aesthetics to the conference-room chair. Height, back and tilt controls, firm lumbar support and a contoured back ensure a comfortable, ergonomic sitting experience.

Standard Features:

- Locking tilt with return safety function
- Pneumatic height adjustment
- Synchronized seat-and-back recline
- Tilt tension control
- Top-stitch detail on seat cover
- Jury base for auditorium seating
- Large 75mm, unhooded, hard wheel casters (for soft flooring)
- Chrome (zinc) or black (plastic) glides
- 26" diameter five-star base

Suffix

"A"

Optional Features:

- Armless (remove painted arm supports) (deduct \$160 list)

"B"

- Verde/Terraverde, Grano/Carrillo or Cremoso/Tierno leather upholstered arm pads (for painted or polished arm supports) (add \$170 list)

- plus additional 3 sq.ft. of COL

"C"

- Verde/Terraverde, Grano/Carrillo or Cremoso/Tierno leather upholstered arm pads & panels (remove painted arm supports) (add \$515 list)

- plus additional 11 sq.ft. of COL

"CAL"

- Contrast stitching (leather covers only) (no upcharge)

- CAL 133 Certified applies to leather & fabric that has a minimum 50% natural fibre content. COM & COL subject to approval. (add \$305 list)

"E"

Caster Chair Options:

- Soft wheel caster (for hard floors) Black (add \$80 list)

- Soft wheel caster (for hard floors) Chrome (add \$60 list)

"F"

- Hard wheel Electrical Static Discharge (ESD) caster (for soft flooring) Chrome (add \$105 list)

"G"

- Fixed-height cylinder (no height adjustment, with swivel) (no upcharge)

"H"

Glide Chair Options:

- Self-Return Base with Pneumatic Height Adjustment (add \$70 list)

"I"

OFFICE SEATING

Nienkämper NOW® Chair – Slim Profile Back Designer - Mark Müller

— CDN Only —

Model Number	Seat H"	Arm H"	W"	D"	H"	Fabric Yds.	Leather Sq. Ft.	COM	COL	Neather	Verde	Grano	Cremoso	Knoll Textiles										
														1	2	3	4							
HORIZONTAL BACK																								
Pneumatic Height Adjustment on Casters																								
	13140	Black Painted Arm Supports, Black Plastic Base, Black Casters													1,950	2,015	2,110	2,555	2,755	2,815	2,190	2,430	2,700	2,960
		18-21	24½-27½	26	24	37½-40½	1¾	22																
	13142	Black Painted Arm Supports, Polished Alum. Base, Chrome Casters													2,135	2,190	2,275	2,725	2,930	3,005	2,375	2,610	2,885	3,140
		18-21	24½-27½	26	24	37½-40½	1¾	22																
	13144	Polished Arm Supports, Black Plastic Base, Black Casters													2,020	2,075	2,175	2,610	2,815	2,890	2,260	2,500	2,770	3,025
		18-21	24½-27½	26	24	37½-40½	1¾	22																
13146	Polished Arm Supports, Polished Alum. Base, Chrome Casters													2,195	2,260	2,350	2,795	3,005	3,070	2,445	2,685	2,950	3,210	
	18-21	24½-27½	26	24	37½-40½	1¾	22																	
13148	Multifunctional Armrests, Black Plastic Base, Black Casters													1,950	2,015	2,110	2,555	2,755	2,815	2,190	2,430	2,700	2,960	
	18-21	24½-27½	27½	24	37½-40½	1¾	10																	
13150	Multifunctional Armrests, Polished Alum. Base, Chrome Casters													2,135	2,190	2,275	2,725	2,930	3,005	2,375	2,610	2,885	3,140	
	18-21	24½-27½	27½	24	37½-40½	1¾	10																	

Pneumatic Height Adjustment on Glides

	13172	Black Painted Arm Supports, Black Plastic Base, Black Glides													1,915	1,965	2,050	2,495	2,700	2,775	2,155	2,390	2,665	2,920
		18-21	24½-27½	26	24	37½-40½	1¾	22																
	13174	Black Painted Arm Supports, Polished Alum. Base, Chrome Glides													2,045	2,115	2,195	2,645	2,855	2,920	2,290	2,530	2,795	3,060
		18-21	24½-27½	26	24	37½-40½	1¾	22																
	13176	Polished Arm Supports, Black Plastic Base, Black Glides													1,970	2,035	2,125	2,570	2,775	2,845	2,220	2,455	2,720	2,980
		18-21	24½-27½	26	24	37½-40½	1¾	22																
13178	Polished Arm Supports, Polished Alum. Base, Chrome Glides													2,120	2,180	2,265	2,710	2,920	2,980	2,360	2,595	2,865	3,125	
	18-21	24½-27½	26	24	37½-40½	1¾	22																	
13180	Multifunctional Armrests, Black Plastic Base, Black Glides													1,915	1,965	2,050	2,495	2,700	2,775	2,155	2,390	2,665	2,920	
	18-21	24½-27½	27½	24	37½-40½	1¾	10																	
13182	Multifunctional Armrests, Polished Alum. Base, Chrome Glides													2,045	2,115	2,195	2,645	2,855	2,920	2,290	2,530	2,795	3,060	
	18-21	24½-27½	27½	24	37½-40½	1¾	10																	

Self-Return Jury Base with Pneumatic Height Adjustment

	13184	Black Painted Arm Supports, Black Plastic Base, Black Casters													2,070	2,175	2,230	2,780	3,015	3,100	2,320	2,560	2,820	3,085
		18-22	24½-28½	26	24	37½-41½	1¾	22																
	13186	Black Painted Arm Supports, Polished Alum. Base, Chrome Casters													2,120	2,230	2,265	2,830	3,065	3,140	2,360	2,595	2,865	3,125
		18-22	24½-28½	26	24	37½-41½	1¾	22																
13188	Polished Arm Supports, Black Plastic Base, Black Casters													2,045	2,145	2,195	2,755	2,990	3,070	2,290	2,530	2,795	3,060	
	18-22	24½-28½	26	24	37½-41½	1¾	22																	

The Nienkämper NOW® Chair brings Nienkämper's renowned fine upholstery and contemporary aesthetics to the conference-room chair. Height, back and tilt controls, firm lumbar support and a contoured back ensure a comfortable, ergonomic sitting experience.

Standard Features:

- Locking tilt with return safety function
- Pneumatic height adjustment
- Synchronized seat-and-back recline
- Tilt tension control
- Top-stitch detail on seat cover
- Jury base for auditorium seating
- Large 75mm, unhooded, hard wheel casters (for soft flooring)
- Chrome (zinc) or black (plastic) glides
- 26" diameter five-star base







Suffix

"A"	Optional Features:	
"B"	• Armless (remove painted arm supports)	(deduct \$160 list)
	• Verde/Terraverde, Grano/Carrillo or Cremoso/Tiemo leather upholstered arm pads (for painted or polished arm supports)	(add \$170 list)
	- plus additional 3 sq.ft. of COL	
"C"	• Verde/Terraverde, Grano/Carrillo or Cremoso/Tiemo leather upholstered arm pads & panels (remove painted arm supports)	(add \$515 list)
	- plus additional 11 sq.ft. of COL	
"CAL"	• Contrast stitching (leather covers only)	(no upcharge)
	• CAL 133 Certified applies to leather & fabric that has a minimum 50% natural fibre content. COM & COL subject to approval.	(add \$305 list)
"E"	Caster Chair Options:	
	• Soft wheel caster (for hard floors)	Black (add \$80 list)
"F"	• Soft wheel caster (for hard floors)	Chrome (add \$60 list)
"G"	• Hard wheel Electrical Static Discharge (ESD) caster (for soft flooring)	Chrome (add \$105 list)
"H"	• Fixed-height cylinder (no height adjustment, with swivel)	(no upcharge)
	Glide Chair Options:	
"I"	• Self-Return Base with Pneumatic Height Adjustment	(add \$70 list)

OFFICE SEATING







Nienkämper NOW® Chair – Mesh Back Designer - Mark Müller

— CDN Only —

Model Number	Seat H"	Arm H"	W"	D"	H"	Fabric Yds.	Leather Sq.Ft.	COM	COL	Mesh	Neather	Verde	Grano	Cremoso	Knoll Textiles			
															1	2	3	4
STANDARD MESH BACK																		
Pneumatic Height Adjustment on Casters																		
	13080	Black Painted Arm Supports, Black Plastic Base, Black Casters																
	18-21	24½-27½	26	24	37½-40½	1¼	10	1,745	1,755	1,650	1,820	2,020	2,115	2,145	1,985	2,230	2,495	2,755
	13082	Black Painted Arm Supports, Polished Alum. Base, Chrome Casters																
	18-21	24½-27½	26	24	37½-40½	1¼	10	1,930	1,945	1,840	2,010	2,195	2,295	2,330	2,170	2,405	2,680	2,935
	13084	Polished Arm Supports, Black Plastic Base, Black Casters																
	18-21	24½-27½	26	24	37½-40½	1¼	10	1,815	1,830	1,730	1,870	2,090	2,180	2,205	2,055	2,295	2,565	2,820
	13086	Polished Arm Supports, Polished Alum. Base, Chrome Casters																
	18-21	24½-27½	26	24	37½-40½	1¼	10	1,995	2,015	1,915	2,070	2,265	2,370	2,395	2,240	2,480	2,745	3,005
	13088	Multifunctional Armrests, Black Plastic Base, Black Casters																
	18-21	24½-27½	27½	24	37½-40½	1¼	10	1,745	1,755	1,650	1,815	2,020	2,115	2,145	1,985	2,230	2,495	2,755
	13090	Multifunctional Armrests, Polished Alum. Base, Chrome Casters																
	18-21	24½-27½	27½	24	37½-40½	1¼	10	1,930	1,945	1,840	1,995	2,195	2,295	2,330	2,170	2,405	2,680	2,935



Pneumatic Height Adjustment on Glides



	13092	Black Painted Arm Supports, Black Plastic Base, Black Glides															
	18-21	24½-27½	26	24	37½-40½	1¼	10	1,705	1,720	1,615	1,760	1,970	2,055	2,110	1,950	2,185	2,455
	13094	Black Painted Arm Supports, Polished Alum. Base, Chrome Glides															
	18-21	24½-27½	26	24	37½-40½	1¼	10	1,845	1,855	1,750	1,925	2,120	2,200	2,245	2,090	2,335	2,595
	13096	Polished Arm Supports, Black Plastic Base, Black Glides															
	18-21	24½-27½	26	24	37½-40½	1¼	10	1,760	1,785	1,680	1,845	2,040	2,135	2,175	2,010	2,245	2,510
	13098	Polished Arm Supports, Polished Alum. Base, Chrome Glides															
	18-21	24½-27½	26	24	37½-40½	1¼	10	1,920	1,930	1,820	1,985	2,185	2,270	2,310	2,160	2,395	2,670
	13100	Multifunctional Armrests, Black Plastic Base, Black Glides															
	18-21	24½-27½	27½	24	37½-40½	1¼	10	1,705	1,720	1,615	1,775	1,970	2,055	2,110	1,950	2,185	2,455
	13102	Multifunctional Armrests, Polished Alum. Base, Chrome Glides															
	18-21	24½-27½	27½	24	37½-40½	1¼	10	1,845	1,855	1,750	1,920	2,120	2,200	2,245	2,090	2,335	2,595

Self-Return Jury Base with Pneumatic Height Adjustment



	13104	Black Painted Arm Supports, Black Aluminum Jury Base															
	18-21	24½-28½	26	24	37½-41½	1¼	10	1,860	1,955	1,775	1,955	2,270	2,410	2,465	2,115	2,350	2,610
	13106	Polished Arm Supports, Black Aluminum Jury Base															
	18-21	24½-28½	26	24	37½-41½	1¼	10	1,935	2,035	1,845	2,030	2,350	2,480	2,530	2,175	2,410	2,685
	13108	Multifunctional Armrest, Black Aluminum Jury Base															
	18-21	24½-28½	27½	24	37½-41½	1¼	10	1,845	1,935	1,750	1,935	2,260	2,390	2,445	2,090	2,335	2,595

The Nienkämper NOW® Chair brings Nienkämper's renowned fine upholstery and contemporary aesthetics to the conference-room chair. Height, back and tilt controls, firm lumbar support and a contoured back ensure a comfortable, ergonomic sitting experience.

Standard Features:

- Locking tilt with return safety function
- Pneumatic height adjustment
- Synchronized seat-and-back recline
- Tilt tension control
- 30 optional mesh colors
- Top-stitch detail on seat cover
- Polyamide mesh back cover
- Jury base for auditorium seating
- Large 75mm, unhooded, hard wheel casters (for soft flooring)
- Chrome (zinc) or black (plastic) glides
- 26" diameter five-star base

Mesh Seat Features:

- When the knitted Seat & Back option is selected, the seat is knitted in one complete piece with no stitching.
- The Seat & Back can be coordinated in 30 standard colors or contrasted – example: Black Seat and Colored Back

Suffix

"A"	Optional Features:	
"B"	• Armless (remove painted arm supports)	(deduct \$160 list)
"C"	• Verde/Terraverde, Grano/Carrillo or Cremoso/Tierno leather upholstered arm pads (for painted or polished arm supports)	(add \$170 list)
"CAL"	• Verde/Terraverde, Grano/Carrillo or Cremoso/Tierno leather upholstered arm pads & panels (remove painted arm supports)	(add \$515 list)
"E"	• Contrast stitching (leather covers only)	(no upcharge)
"F"	• CAL 133 Certified applies to leather & fabric that has a minimum 50% natural fibre content. COM & COL subject to approval.	(add \$305 list)
"G"	Caster Chair Options:	
"H"	• Soft wheel caster (for hard floors)	Black (add \$80 list)
"I"	• Soft wheel caster (for hard floors)	Chrome (add \$60 list)
	• Hard wheel Electrical Static Discharge (ESD) caster (for soft flooring)	Chrome (add \$105 list)
	• Fixed-height cylinder (no height adjustment, with swivel)	(no upcharge)
	Glide Chair Options:	
	• Self-Return Base with Pneumatic Height Adjustment	(add \$70 list)

OFFICE SEATING

Nienkämper NOW® Chair – Mesh Back Designer - Mark Müller

— CDN Only —

Model Number	Seat H"	Arm H"	W"	D"	H"	Fabric Yds.	Leather Sq. Ft.	COM	COL	Mesh	Neather	Verde	Grano	Cremoso	Knoll Textiles			
															1	2	3	4

HORIZONTAL MESH BACK

Pneumatic Height Adjustment on Casters



13080H Black Painted Arm Supports, Black Plastic Base, Black Casters	18-21	24½-27½	26	24	37½-40½	¾	10	1,745	1,755	1,650	1,820	2,020	2,115	2,145	1,850	1,955	2,065	2,175
13082H Black Painted Arm Supports, Polished Alum. Base, Chrome Casters	18-21	24½-27½	26	24	37½-40½	¾	10	1,930	1,945	1,840	2,010	2,195	2,295	2,330	2,035	2,140	2,250	2,360
13084H Polished Arm Supports, Black Plastic Base, Black Casters	18-21	24½-27½	26	24	37½-40½	¾	10	1,815	1,830	1,730	1,870	2,090	2,180	2,205	1,925	2,025	2,140	2,245
13086H Polished Arm Supports, Polished Alum. Base, Chrome Casters	18-21	24½-27½	26	24	37½-40½	¾	10	1,995	2,015	1,915	2,070	2,265	2,370	2,395	2,110	2,200	2,320	2,425
13088H Multifunctional Armrests, Black Plastic Base, Black Casters	18-21	24½-27½	27½	24	37½-40½	¾	10	1,745	1,755	1,650	1,815	2,020	2,115	2,145	1,850	1,955	2,065	2,175
13090H Multifunctional Armrests, Polished Alum. Base, Chrome Casters	18-21	24½-27½	27½	24	37½-40½	¾	10	1,930	1,945	1,840	1,995	2,195	2,295	2,330	2,035	2,140	2,250	2,360

Pneumatic Height Adjustment on Glides



13092H Black Painted Arm Supports, Black Plastic Base, Black Glides	18-21	24½-27½	26	24	37½-40½	¾	10	1,705	1,720	1,615	1,760	1,970	2,055	2,110	1,815	1,920	2,030	2,140
13094H Black Painted Arm Supports, Polished Alum. Base, Chrome Glides	18-21	24½-27½	26	24	37½-40½	¾	10	1,845	1,855	1,750	1,925	2,120	2,200	2,245	1,955	2,055	2,170	2,275
13096H Polished Arm Supports, Black Plastic Base, Black Glides	18-21	24½-27½	26	24	37½-40½	¾	10	1,760	1,785	1,680	1,845	2,040	2,135	2,175	1,865	1,970	2,080	2,190
13098H Polished Arm Supports, Polished Alum. Base, Chrome Glides	18-21	24½-27½	26	24	37½-40½	¾	10	1,920	1,930	1,820	1,985	2,185	2,270	2,310	2,025	2,130	2,240	2,350
13100H Multifunctional Armrests, Black Plastic Base, Black Glides	18-21	24½-27½	27½	24	37½-40½	¾	10	1,705	1,720	1,615	1,775	1,970	2,055	2,110	1,815	1,920	2,030	2,140
13102H Multifunctional Armrests, Polished Alum. Base, Chrome Glides	18-21	24½-27½	27½	24	37½-40½	¾	10	1,845	1,855	1,750	1,920	2,120	2,200	2,245	1,955	2,055	2,170	2,275

Self-Return Jury Base with Pneumatic Height Adjustment



13104H Black Painted Arm Supports, Black Aluminum Jury Base	18-22	24½-28½	26	24	37½-41½	¾	10	1,860	1,955	1,775	1,955	2,270	2,410	2,465	1,970	2,070	2,185	2,295
13106H Polished Arm Supports, Black Aluminum Jury Base	18-22	24½-28½	26	24	37½-41½	¾	10	1,935	2,035	1,845	2,030	2,350	2,480	2,530	2,040	2,145	2,255	2,365
13108H Multifunctional Armrest, Black Aluminum Jury Base	18-22	24½-28½	27½	24	37½-41½	¾	10	1,845	1,935	1,750	1,935	2,260	2,390	2,445	1,955	2,055	2,170	2,275

The Nienkämper NOW® Chair brings Nienkämper's renowned fine upholstery and contemporary aesthetics to the conference-room chair. Height, back and tilt controls, firm lumbar support and a contoured back ensure a comfortable, ergonomic sitting experience.

Standard Features:

- Locking tilt with return safety function
- Pneumatic height adjustment
- Synchronized seat-and-back recline
- Tilt tension control
- 30 optional mesh colors
- Top-stitch detail on seat cover
- Polyamide mesh back cover
- Jury base for auditorium seating
- Large 75mm, unhooded, hard wheel casters (for soft flooring)
- Chrome (zinc) or black (plastic) glides
- 26" diameter five-star base

Mesh Seat Features:

- When the knitted Seat & Back option is selected, the seat is knitted in one complete piece with no stitching.
- The Seat & Back can be coordinated in 30 standard colors or contrasted – example: Black Seat and Colored Back

Suffix

"A"	Optional Features:	
"B"	• Armless (remove painted arm supports)	(deduct \$160 list)
"C"	• Verde/Terraverde, Grano/Carrillo or Cremoso/Tierno leather upholstered arm pads (for painted or polished arm supports)	(add \$170 list)
"CAL"	- plus additional 3 sq.ft. of COL	
"E"	• Verde/Terraverde, Grano/Carrillo or Cremoso/Tierno leather upholstered arm pads & panels (remove painted arm supports)	(add \$515 list)
"F"	- plus additional 11 sq.ft. of COL	
"G"	• Contrast stitching (leather covers only)	(no upcharge)
"H"	• CAL 133 Certified applies to leather & fabric that has a minimum 50% natural fibre content. COM & COL subject to approval.	(add \$305 list)
"I"	Caster Chair Options:	
	• Soft wheel caster (for hard floors)	Black (add \$80 list)
	• Soft wheel caster (for hard floors)	Chrome (add \$60 list)
	• Hard wheel Electrical Static Discharge (ESD) caster (for soft flooring)	Chrome (add \$105 list)
	• Fixed-height cylinder (no height adjustment, with swivel)	(no upcharge)
	Glide Chair Options:	
	• Self-Return Base with Pneumatic Height Adjustment	(add \$70 list)

OFFICE SEATING

Nienkämper NOW® Chair – Mesh Back Designer - Mark Müller

— CDN Only —

Model Number	Seat H"	Arm H"	W"	D"	H"	Fabric Yds.	Leather Sq. Ft.	COM	COL	Mesh	Neather	Verde	Grano	Cremoso	Knoll Textiles			
															1	2	3	4

BOX MESH BACK

Pneumatic Height Adjustment on Casters



13080B Black Painted Arm Supports, Black Plastic Base, Black Casters	18-21	24½-27½	26	24	37½-40½	¾	10	1,745	1,755	1,650	1,820	2,020	2,115	2,145	1,850	1,955	2,065	2,175
13082B Black Painted Arm Supports, Polished Alum. Base, Chrome Casters	18-21	24½-27½	26	24	37½-40½	¾	10	1,930	1,945	1,840	2,010	2,195	2,295	2,330	2,035	2,140	2,250	2,360
13084B Polished Arm Supports, Black Plastic Base, Black Casters	18-21	24½-27½	26	24	37½-40½	¾	10	1,815	1,830	1,730	1,870	2,090	2,180	2,205	1,925	2,025	2,140	2,245
13086B Polished Arm Supports, Polished Alum. Base, Chrome Casters	18-21	24½-27½	26	24	37½-40½	¾	10	1,995	2,015	1,915	2,070	2,265	2,370	2,395	2,110	2,200	2,320	2,425
13088B Multifunctional Armrests, Black Plastic Base, Black Casters	18-21	24½-27½	27½	24	37½-40½	¾	10	1,745	1,755	1,650	1,815	2,020	2,115	2,145	1,850	1,955	2,065	2,175
13090B Multifunctional Armrests, Polished Alum. Base, Chrome Casters	18-21	24½-27½	27½	24	37½-40½	¾	10	1,930	1,945	1,840	1,995	2,195	2,295	2,330	2,035	2,140	2,250	2,360

Pneumatic Height Adjustment on Glides



13092B Black Painted Arm Supports, Black Plastic Base, Black Glides	18-21	24½-27½	26	24	37½-40½	¾	10	1,705	1,720	1,615	1,760	1,970	2,055	2,110	1,815	1,920	2,030	2,140
13094B Black Painted Arm Supports, Polished Alum. Base, Chrome Glides	18-21	24½-27½	26	24	37½-40½	¾	10	1,845	1,855	1,750	1,925	2,120	2,200	2,245	1,955	2,055	2,170	2,275
13096B Polished Arm Supports, Black Plastic Base, Black Glides	18-21	24½-27½	26	24	37½-40½	¾	10	1,760	1,785	1,680	1,845	2,040	2,135	2,175	1,865	1,970	2,080	2,190
13098B Polished Arm Supports, Polished Alum. Base, Chrome Glides	18-21	24½-27½	26	24	37½-40½	¾	10	1,920	1,930	1,820	1,985	2,185	2,270	2,310	2,025	2,130	2,240	2,350
13100B Multifunctional Armrests, Black Plastic Base, Black Glides	18-21	24½-27½	27½	24	37½-40½	¾	10	1,705	1,720	1,615	1,775	1,970	2,055	2,110	1,815	1,920	2,030	2,140
13102B Multifunctional Armrests, Polished Alum. Base, Chrome Glides	18-21	24½-27½	27½	24	37½-40½	¾	10	1,845	1,855	1,750	1,920	2,120	2,200	2,245	1,955	2,055	2,170	2,275

Self-Return Jury Base with Pneumatic Height Adjustment



13104B Black Painted Arm Supports, Black Aluminum Jury Base	18-22	24½-28½	26	24	37½-41½	¾	10	1,860	1,955	1,775	1,955	2,270	2,410	2,465	1,970	2,070	2,185	2,295
13106B Polished Arm Supports, Black Aluminum Jury Base	18-22	24½-28½	26	24	37½-41½	¾	10	1,935	2,035	1,845	2,030	2,350	2,480	2,530	2,040	2,145	2,255	2,365
13108B Multifunctional Armrest, Black Aluminum Jury Base	18-22	24½-28½	26	24	37½-41½	¾	10	1,845	1,935	1,750	1,935	2,260	2,390	2,445	1,955	2,055	2,170	2,275

The Nienkämper NOW® Chair brings Nienkämper's renowned fine upholstery and contemporary aesthetics to the conference-room chair. Height, back and tilt controls, firm lumbar support and a contoured back ensure a comfortable, ergonomic sitting experience.

Standard Features:

- Locking tilt with return safety function
- Pneumatic height adjustment
- Synchronized seat-and-back recline
- Tilt tension control
- 30 optional mesh colors
- Top-stitch detail on seat cover
- Polyamide mesh back cover
- Jury base for auditorium seating
- Large 75mm, unhooded, hard wheel casters (for soft flooring)
- Chrome (zinc) or black (plastic) glides
- 26" diameter five-star base







Mesh Seat Features:

- When the knitted Seat & Back option is selected, the seat is knitted in one complete piece with no stitching.
- The Seat & Back can be coordinated in 30 standard colors or contrasted – example: Black Seat and Colored Back

Suffix	Optional Features:	
"A"	• Armless (remove painted arm supports)	(deduct \$160 list)
"B"	• Verde/Terraverde, Grano/Carrillo or Cremoso/Tierno leather upholstered arm pads (for painted or polished arm supports)	(add \$170 list)
	- plus additional 3 sq.ft. of COL	
"C"	• Verde/Terraverde, Grano/Carrillo or Cremoso/Tierno leather upholstered arm pads & panels (remove painted arm supports)	(add \$515 list)
	- plus additional 11 sq.ft. of COL	
	• Contrast stitching (leather covers only)	(no upcharge)
"CAL"	• CAL 133 Certified applies to leather & fabric that has a minimum 50% natural fibre content. COM & COL subject to approval.	(add \$305 list)
	Caster Chair Options:	
"E"	• Soft wheel caster (for hard floors)	Black (add \$80 list)
"F"	• Soft wheel caster (for hard floors)	Chrome (add \$60 list)
"G"	• Hard wheel Electrical Static Discharge (ESD) caster (for soft flooring)	Chrome (add \$105 list)
	• Fixed-height cylinder (no height adjustment, with swivel)	(no upcharge)
"H"	Glide Chair Options:	
"I"	• Self-Return Base with Pneumatic Height Adjustment	(add \$70 list)

OFFICE SEATING

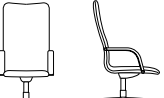
Senator® Boardroom Designer – Nienkämper

														— CDN Only —			
Model Number	Seat H"	Arm		D"	H"	Fabric Yds.	Leather Sq. Ft.	COM	COL	Neather	Verde	Grano	Cremoso	Knoll Textiles			
		H"	W"											1	2	3	4
LOWBACK																	
	1464_	18½-21½	25	25	25	36											
	(Model #1)	Urethane arm				1¼	22	1,980	2,070	2,120	2,800	3,015	3,110	2,230	2,465	2,730	2,995
	(Model #9)	Urethane arm with wrap				1½	24	2,190	2,305	2,350	3,140	3,375	3,475	2,400	2,605	2,830	3,060
	(Model #2)	Urethane arm with cap				1½	24	2,190	2,305	2,350	3,140	3,375	3,475	2,400	2,605	2,830	3,060
	(Model #3)	Urethane arm with cap and wrap				1¾	26	2,250	2,370	2,455	3,270	3,545	3,635	2,495	2,730	3,000	3,265
MEDIUM BACK																	
	1465_	18½-21½	25	25	25	40½											
	(Model #1)	Urethane arm				1¼	30	2,010	2,110	2,140	3,125	3,420	3,545	2,180	2,355	2,540	2,725
	(Model #9)	Urethane arm with wrap				1½	32	2,205	2,330	2,390	3,420	3,725	3,850	2,415	2,620	2,855	3,075
	(Model #2)	Urethane arm with cap				1½	32	2,205	2,330	2,390	3,420	3,725	3,850	2,415	2,620	2,855	3,075
	(Model #3)	Urethane arm with cap and wrap				1¾	34	2,295	2,400	2,480	3,485	3,805	3,930	2,540	2,780	3,045	3,305
HIGH BACK																	
	1466_	18½-21½	25	25	25	45											
	(Model #1)	Urethane arm				1¼	36	2,045	2,145	2,205	3,210	3,510	3,625	2,225	2,390	2,580	2,770
	(Model #9)	Urethane arm with wrap				1¾	38	2,260	2,390	2,465	3,505	3,825	3,955	2,505	2,745	3,010	3,275
	(Model #2)	Urethane arm with cap				1¾	38	2,260	2,390	2,415	3,385	3,685	3,805	2,505	2,745	3,010	3,275
	(Model #3)	Urethane arm with cap and wrap				2	40	2,340	2,455	2,570	3,580	3,900	4,045	2,610	2,890	3,185	3,490

Senator Boardroom series is available as CAL 133 certified for an upcharge of \$165 list per chair. Certification applies to Nienkämper leathers and fabrics that have a minimum of 50% natural fibre content. COM's and COL's are subject to approval. Add the extension "-CAL" to the model number when ordering.

Specify model number for arm selection.

Standard Features:

- Pneumatic height adjustment
- Back tilt locking mechanism
- Back tilt tension control
- Carpet casters
- Black five-star base

Optional Features:

- Hard floor casters, add \$105 list per chair
- Glides, add \$105 list per chair
- Polished aluminum five-star base, add \$210 list

Model # 14652
Medium Back



Model # 14652
Medium Back



OFFICE SEATING

Senator® CEO Designer – Nienkämper

— CDN Only —
Knoll Textiles

Model Number	Seat H"	Arm H" W" D" H"	Fabric Yds.	Leather Sq. Ft.	COM	COL	Verde	Grano	Cremoso	1	2	3	4
--------------	---------	-----------------	-------------	-----------------	-----	-----	-------	-------	---------	---	---	---	---

LOWBACK



1461_ 18½-21½ 25 25 28 36

(Model #1) Urethane arm	2	34
(Model #9) Urethane arm with wrap	2¼	37
(Model #2) Urethane arm with cap	2¼	27
(Model #3) Urethane arm with cap and wrap	2½	39
(Model #8) Closed arm	2¾	44

2,920	3,065	4,120	4,440	4,560	3,195	3,475	3,770	4,070
3,145	3,295	4,485	4,845	4,990	3,460	3,765	4,110	4,445
3,145	3,295	4,485	4,845	4,990	3,460	3,765	4,110	4,445
3,235	3,380	4,715	5,105	5,270	3,580	3,920	4,295	4,670
3,585	3,770	5,235	5,665	5,835	3,960	4,345	4,765	5,170

MEDIUM BACK



1462_ 18½-21½ 25 25 28 40½

(Model #1) Urethane arm	2¼	38
(Model #9) Urethane arm with wrap	2½	41
(Model #2) Urethane arm with cap	2½	41
(Model #3) Urethane arm with cap and wrap	2¾	43
(Model #8) Closed arm	3	48

3,055	3,200	4,395	4,765	4,895	3,360	3,670	4,015	4,345
3,255	3,420	4,765	5,160	5,315	3,600	3,940	4,325	4,690
3,255	3,420	4,765	5,160	5,315	3,600	3,940	4,325	4,690
3,350	3,510	4,995	5,425	5,605	3,730	4,115	4,525	4,935
3,700	3,895	5,490	5,970	6,170	4,115	4,525	4,980	5,425

HIGH BACK



1463_ 18½-21½ 25 25 28 45

(Model #1) Urethane arm	2½	40
(Model #9) Urethane arm with wrap	2¾	43
(Model #2) Urethane arm with cap	2¾	43
(Model #3) Urethane arm with cap and wrap	3	45
(Model #8) Closed arm	3¼	50

3,635	3,820	5,145	5,535	5,705	3,980	4,325	4,700	5,070
3,145	4,055	5,525	5,940	6,125	3,525	3,910	4,325	4,725
3,875	4,055	5,525	5,940	6,125	4,255	4,635	5,050	5,455
3,950	4,145	5,755	6,215	6,415	4,370	4,785	5,230	5,680
4,320	4,535	6,275	6,765	6,970	4,770	5,215	5,705	6,185

Senator CEO series is available as CAL 133 certified for an upcharge of \$290 list per chair. Certification applies to Nienkämper leathers and fabrics that have a minimum of 50% natural fibre content. COM's and COL's are subject to approval. Add the extension "-CAL" to the model number when ordering.

Specify model number for arm selection.

Standard Features:

- Pneumatic height adjustment
- Back tilt locking mechanism
- Back tilt tension control
- Carpet casters
- Black five-star base

Optional Features:

- Hard floor casters, add \$105 list per chair
- Glides, add \$105 list per chair
- Polished aluminum five-star base, add \$210 list

Model # 14622
Medium Back



OFFICE SEATING

Senator® Classic Designer – Nienkämper

Model Number	Seat H"	Arm		D"	H"	Fabric Yds.	Leather Sq.Ft.	COM	COL	Verde	Grano	Cremoso	— CDN Only — Knoll Textiles			
		H"	W"										1	2	3	4

MEDIUM BACK



14101	19½-23	25½	25½	26	41-44½	3	54											
								3,780	3,960	5,605	6,100	6,300	4,200	4,610	5,060	5,510		

HIGHBACK



14102	19½-23	25½	25½	26	44½-49	3	59											
								4,400	4,615	6,390	6,920	7,120	4,815	5,230	5,680	6,130		





Standard Features

- Pneumatic height adjustment
- Back tilt locking mechanism
- Back tilt tension control
- Carpet casters
- Black five-star base



OFFICE SEATING

Senator® Executive Designer – Nienkämper



— US Only —

Model Number	Seat H"	Arm				Fabric Yds.	Leather Sq.Ft.	Knoll Textiles										
		H"	W"	D"	H"			COM	COL	Neather	Verde	Grano	Cremoso	1	2	3	4	
LOW BACK																		
 	1411	18½-21½	25	25	26	36												
(Model #1) Urethane arm							1¼	32	2,700	2,835	2,900	3,900	4,215	4,345	2,870	3,015	3,180	3,350
(Model #2) Urethane arm with cap							2	35	2,920	3,065	3,145	4,240	4,575	4,710	3,115	3,285	3,475	3,665
 	(Model #3) Urethane arm with cap & wrap						2¼	37	2,970	3,140	3,235	4,370	4,720	4,875	3,185	3,380	3,590	3,815
(Model #8) Closed arm							2¾	42	3,335	3,485	3,620	4,895	5,315	5,480	3,595	3,835	4,095	4,355
(Model #7) Sled base with cap							2¼	34	3,690	3,880	3,940	4,965	5,295	5,430	3,905	4,095	4,300	4,525

MEDIUM BACK

 	1412	18½-21½	25	25	26	40½													
(Model #1) Urethane arm							2	36	2,830	2,960	3,055	4,175	4,535	4,670	3,025	3,195	3,385	3,580	
(Model #2) Urethane arm with cap							2¼	39	3,015	3,165	3,255	4,480	4,870	5,010	3,235	3,430	3,635	3,855	
(Model #3) Urethane arm with cap & wrap							2½	41	3,110	3,255	3,380	4,645	5,050	5,200	3,345	3,560	3,800	4,040	
(Model #8) Closed arm							3	46	3,440	3,610	3,770	5,160	5,605	5,795	3,720	3,980	4,265	4,560	

HIGH BACK

 	1413	18½-21½	25	25	26	45													
(Model #1) Urethane arm							2¼	38	3,380	3,550	3,620	4,800	5,175	5,325	3,595	3,790	4,005	4,225	
(Model #2) Urethane arm with cap							2½	41	3,590	3,775	3,875	5,115	5,530	5,705	3,830	4,045	4,275	4,515	
(Model #3) Urethane arm with cap & wrap							2¾	43	3,670	3,845	3,960	5,270	5,705	5,870	3,930	4,165	4,435	4,690	
(Model #8) Closed arm							3	48	4,005	4,185	4,340	5,795	6,275	6,465	4,280	4,545	4,825	5,115	

Senator Executive series is available as CAL 133 certified for an upcharge of \$305 list per chair. Certification applies to Nienkämper leathers and fabrics that have a minimum of 50% natural fibre content. COM's and COL's are subject to approval. Add the extension "-CAL" to the model number when ordering.

Specify model number for arm selection.

Standard Features:

- Pneumatic height adjustment
- Back tilt locking mechanism
- Tension control
- Carpet casters
- Black five-star base

Optional Features:

- Hard floor casters, add \$105 list per chair
- Glides, add \$105 list per chair
- Polished aluminum five-star base, add \$210 list
- Chrome finish sled base, add \$165 list

Upholstery Details:

- Leather upholstery has channel stitching.
- Fabric upholstery is available with channel stitch finished with a French seam detail.

Model # 14122
Medium Back



Model # 1
Urethane Arm



Model # 2
Urethane arm
with Cap



Model # 3
Urethane Arm with
Cap and Wrap



Model # 8
Closed Arm



OFFICE SEATING

Senator Mesh Back Chair Designer – Nienkämper

— CDN Only —
Knoll Textiles

Model Number	Seat H"	Arm H"	W"	D"	H"	Fabric Yds.	Leather Sq. Ft.	COM	COL	Neather	Verde	Grano	Cremoso	1	2	3	4
--------------	---------	--------	----	----	----	-------------	-----------------	-----	-----	---------	-------	-------	---------	---	---	---	---

SENATOR MESH BACK CHAIR - ADJUSTABLE ARMS



														Upholstered seat				
14301	Grey arms, back frame and base	17½-21½	23½	23½	24	36¼-40¼	¾	14	1,070	1,120	1,145	1,470	1,540	1,575	1,175	1,280	1,390	1,500
														Mesh seat				
14302	Grey arms, back frame and base	17½-21½	23½	23½	24	36¼-40¼			1,070									

SENATOR MESH BACK CHAIR - ADJUSTABLE ARMS



														Upholstered seat				
14305	Black arms, back frame and base	17½-21½	23½	23½	24	36¼-40¼	¾	14	1,010	1,050	1,080	1,410	1,480	1,510	1,120	1,220	1,335	1,445
														Mesh seat				
14306	Black arms, back frame and base	17½-21½	23½	23½	24	36¼-40¼			1,010									

Standard Features

- Mesh back, fabric seat & headrest is standard in black
- Mesh back with lumbar support, lumbar support has 2" adjustment
- Adjustment arms with 3" height adjustment and 1¾" depth adjustment
- Pneumatic height adjustment
- Black or grey five star base is standard, add \$105 list for polished aluminum base with chrome casters

Model # 14301



Model # 14301



OFFICE SEATING

Senator® Nuvo Designer – nienkämper

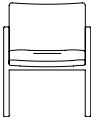
Model Number	Seat H"	Arm H"	W"	D"	H"	Fabric Yds.	Leather Sq.Ft.	COM	COL	Verde	Grano	Cremoso	— CDN Only — Knoll Textiles			
													1	2	3	4
 14103	17½	24½	23	25	31	1¼	31	2,135	2,240	2,750	3,005	3,070	2,305	2,480	2,670	2,855

Standard Features

- Chrome tubular sled base
- Plain upholstery

 14104	17½	24½	23	25	31	1¼	31	3,290	3,455	3,900	4,155	4,240	3,465	3,635	3,825	4,015
--	-----	-----	----	----	----	----	----	-------	-------	-------	-------	-------	-------	-------	-------	-------

																
---	--	--	--	--	--	--	--	--	--	--	--	--	--	--	--	--

Standard Features

- Solid flat chrome sled base
- Tufted upholstery

ARMCHAIR CASTERBASE

 14107	17½	24½	23	25	31	1¼	31	2,340	2,460	2,940	3,145	3,200	2,510	2,685	2,870	3,060
--	-----	-----	----	----	----	----	----	-------	-------	-------	-------	-------	-------	-------	-------	-------

Standard Features

- Chrome or black base
- Chrome or black casters
- Plain upholstery

Model # 14103
Senator® Nuvo Armchair
with tubular chrome sled base



Model # 14105
Senator® Nuvo Armchair
with flat chrome sled base



Model # 14107
Senator® Nuvo Armchair Caster Base





OFFICE SEATING

Senit Chair Designer – Nienkämper

Model Number	Seat H"	Arm				Fabric Yds.	Leather Sq.Ft.	COM	COL	Neather	Verde	Grano	Cremoso	— CDN Only — KnollTextiles			
		H"	W"	D"	H"									1	2	3	4

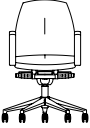

LOWBACK

10950	18½-21½	25	25	25	36	1¼	22	1,010	1,060	1,125	1,600	1,810	1,860	1,185	1,355	1,540	1,730
--------------	---------	----	----	----	----	----	----	-------	-------	-------	-------	-------	-------	-------	-------	-------	-------

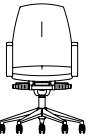

MEDIUM BACK

10951	18½-21½	25	25	25	40½	1¼	30	1,030	1,075	1,150	1,845	2,120	2,200	1,205	1,380	1,565	1,750
--------------	---------	----	----	----	-----	----	----	-------	-------	-------	-------	-------	-------	-------	-------	-------	-------

HIGH BACK

10952	18½-21½	25	25	25	45	1½	36	1,065	1,105	1,200	2,035	2,375	2,475	1,275	1,480	1,705	1,930
--------------	---------	----	----	----	----	----	----	-------	-------	-------	-------	-------	-------	-------	-------	-------	-------

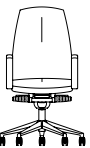
Standard Features:

- Pneumatic height adjustment
- Back tilt locking mechanism
- Back tilt tension control
- Carpet casters
- Black five-star base

Optional Features:

- Hard floor casters, add \$105 list per chair
- Glides, add \$105 list per chair
- Polished aluminum five-star base, add \$210 list

Model #10952



OFFICE SEATING

Shaker Designer – Nienkamper

— CDN Only —
Knoll Textiles

Model Number	Seat H"	W"	D"	H"	Fabric Yds.	Leather Sq.Ft.	COM	COL	Neather	Verde	Grano	Cremoso	1	2	3	4
--------------	---------	----	----	----	-------------	----------------	-----	-----	---------	-------	-------	---------	---	---	---	---

SHAKER CHAIR - SWIVEL BASE



13910	17 3/4	24 3/4	21 1/4	29 1/4	1 3/4	28	2,455	2,580	2,610	3,345	3,445	3,530	2,570	2,680	2,795	2,920
-------	--------	--------	--------	--------	-------	----	-------	-------	-------	-------	-------	-------	-------	-------	-------	-------

SHAKER CHAIR - ON LEGS



13911	17 1/4	24 3/4	21 1/4	28 3/4	1 3/4	28	2,190	2,305	2,355	3,075	3,175	3,265	2,305	2,415	2,535	2,665
-------	--------	--------	--------	--------	-------	----	-------	-------	-------	-------	-------	-------	-------	-------	-------	-------

SHAKER CHAIR - ON WOOD LEGS



13912	17 1/4	24 3/4	21 1/4	28 3/4	1 3/4	28	2,745	2,885	2,905	3,650	3,745	3,835	2,860	2,970	3,085	3,215
-------	--------	--------	--------	--------	-------	----	-------	-------	-------	-------	-------	-------	-------	-------	-------	-------

Model # 13910, 13911 & 13912 Shaker Chairs



Standard Features

- Shaped hardwood arm, back and j-bar.
- Tubular steel leg frame, caster base and four wooden legs are standard.
- Solid wood maple back/leg available in various Nienkamper stains and sheen levels.
- Upholstery available in all Nienkamper standard fabrics and leather.
- Metal base standard in satin black powder coat.

OFFICE SEATING

Slim Chair Designer – Nienkämper

Model Number	Seat H"	Arm H"	W"	D"	H"	Fabric Yds.	Leather Sq.Ft.	COM	COL	Neather	Verde	Grano	Cremoso	— CDN Only — Knoll Textiles			
														1	2	3	4

SLIM HIGHBACK - ARMLESS



10761	19-22		19	25	45	1½	30	1,325	1,400	1,500	2,235	2,385	2,465	1,570	1,805	2,060	2,310
--------------	-------	--	----	----	----	----	----	-------	-------	-------	-------	-------	-------	-------	-------	-------	-------

SLIM HIGHBACK - FIXED ARM



10762	19-22	26-29	25½	25	45	1½	30	1,600	1,675	1,760	2,505	2,670	2,745	1,830	2,060	2,330	2,580
--------------	-------	-------	-----	----	----	----	----	-------	-------	-------	-------	-------	-------	-------	-------	-------	-------

SLIM HIGHBACK - CANTILEVER ARM



10763	19-22	26-29	25½	25	45	1½	30	1,565	1,630	1,705	2,300	2,445	2,510	1,805	2,035	2,290	2,555
--------------	-------	-------	-----	----	----	----	----	-------	-------	-------	-------	-------	-------	-------	-------	-------	-------

Standard Features

- Moulded plywood seat shell
- Soy based flexible polyurethane foam
- Fixed arm model has polished aluminum arm supports and black soft textured arm cap
- Cantilever arm model has polished sides with black textured arm cap
- Pneumatic height adjustment
- Back tilt locking mechanism
- Carpet casters
- Black five-star base & casters

Optional Features

- Hard floor casters, add \$105 list per chair
- Glides, add \$105 list per chair
- Polished aluminum five-star base with chrome casters, add \$70 list

Model # 10763

Slim high back with cantilever arms with polished sides and black textured arm cap

Model # 10761



Model # 10762



OFFICE SEATING

Trench - Upholstered Arms Designer – Favaretto & Partners

Model Number	Seat H"	Arm H"	W"	D"	H"	Fabric Yds.	Leather Sq.Ft.	COM	COL	— CDN Only — Knoll Textiles			
										Neather	Verde	Grano	Cremoso

TRENCH LOW BACK - UPHOLSTERED ARMS



10371	18-21	27-30	25½	26	35½-38½	2½	45
--------------	-------	-------	-----	----	---------	----	----

Extra sq. ft. COL for pleats detail on inside back: 5

2,365	2,485	2,590	3,620	3,840	3,945	2,710	3,055	3,435	3,805
-------	-------	-------	-------	-------	-------	-------	-------	-------	-------

TRENCH MEDIUM BACK - UPHOLSTERED ARMS



10372	18-21	27-30	25½	26	40½-43½	3	54
--------------	-------	-------	-----	----	---------	---	----

Extra sq. ft. COL for pleats detail on inside back: 5

2,475	2,595	2,745	3,960	4,225	4,350	2,890	3,300	3,745	4,200
-------	-------	-------	-------	-------	-------	-------	-------	-------	-------

TRENCH HIGH BACK WITH HEADREST - UPHOLSTERED ARMS



10373	18-21	27-30	25½	26	48½-51½	3-½	63
--------------	-------	-------	-----	----	---------	-----	----

Extra sq. ft. COL for pleats detail on inside back: 5

2,805	2,955	3,125	4,545	4,850	5,000	3,290	3,770	4,295	4,820
-------	-------	-------	-------	-------	-------	-------	-------	-------	-------

Standard Features

- Seat depth : 20"D, Headrest : 8"H
- Steel frame with polyurethane foam
- Distinctive pleats on the convex inside back for both leather & fabric upholstery is standard in Verde leather
- Extra 5 sqft. COL is required for pleats detail
- Upholstered arms and adjustable arms are both available
- Pneumatic height adjustment
- Synchronized seat and back recline
- Black five star base and 3" dia. carpet casters are standard
- Add \$70 list for mirror polished base with chrome casters

Model # 10372

Trench medium back chair upholstered in Ecopell leather, colour Caramel EC363 with Ecopell leather, colour Milkshake EC737 pleats detail on inside back



OFFICE SEATING

Vuelo Designer – Johnson chou

— CDN Only —

Model Number	Seat H"	Arm H"	W"	D"	H"	Fabric Yds.	Leather Sq.Ft.	COM	COL	Neather	Verde	Grano	Cremoso	KNOLL TEXTILES			
														1	2	3	4

VUELO LOWBACK



Model	Description	Fabric Yds.	Leather Sq.Ft.	COM	COL	Neather	Verde	Grano	Cremoso	1	2	3	4
10072	17-20 23-26 26 23½ 33-36 fully upholstered	2¼	41	2,825	2,970	3,055	4,075	4,300	4,425	3,140	3,450	3,790	4,125
10072/1	contrasting fabric seat & back arms & bottom	1¼	1	2,825		3,055				3,005	3,175	3,360	3,550
10072/2	contrasting leather seat & back arms & bottom	23	18		2,970		4,075	4,300	4,425				
10072/3	fabric seat & back with Verde leather arms & bottom	1¼	18	3,460						3,635	3,810	4,000	4,180

VUELO HIGHBACK



Model	Description	Fabric Yds.	Leather Sq.Ft.	COM	COL	Neather	Verde	Grano	Cremoso	1	2	3	4
10071	17-20 23-26 26 25 42-45 fully upholstered	2½	45	3,060	3,210	3,300	4,440	4,675	4,800	3,400	3,740	4,125	4,490
10071/1	contrasting fabric seat & back arms & bottom	1½	1	3,060		3,300				3,270	3,475	3,700	3,920
10071/2	contrasting leather seat & back arms & bottom	27	18		3,210		4,075	4,300	4,425				
10071/3	fabric seat & back with Verde leather arms & bottom	1½	18	3,700						3,910	4,115	4,340	4,565

Standard features:

- Moulded plywood seat and arm shell
- Soy based flexible polyurethane foam
- Polished aluminum five star base with chrome casters
- Pneumatic Height Adjustment
- Back tilt locking mechanism
- For model "/3" with fabric seat & back and verde leather arms & bottom, welting detail on the back in same Verde leather is standard

Model # 10072



Model # 10072/3

Fabric seat and back with Verde leather arms & bottom.



nienkämper

International Inc.

SIDE CHAIRS



SIDE CHAIRS

TABLE OF CONTENTS



Side Chairs	43-54
Brackett®	45
HSC	46
Kush	47
Nabu Side/Stacking Chair	48-50
Q Side Chair	51
Schultz	52
Senator® Nuvo Sled Base	53
Unesco™	54

SIDE CHAIRS

Brackett® Chair Designer – lothar windel

Model Number	Seat H"	Arm H"	W"	D"	H"	Fabric Yds.	Leather Sq.Ft.	COM	COL	Verde	Grano	Cremoso	— CDN Only — Knoll Textiles			
													1	2	3	4

LOWBACK

	Five-star black base																	
	14761	17½-20½	24½	26	26	31½-34½	2¼	40	1,820	1,920	3,065	3,385	3,510	2,135	2,440	2,780	3,115	
	Four legs																	
	14762	18½	25½	26	23	32	2¼	40	1,705	1,785	2,950	3,270	3,400	2,020	2,330	2,670	3,000	
	Sled base																	
	14763	18½	25½	26	23	32	2¼	40	1,730	1,810	2,960	3,290	3,420	2,040	2,350	2,690	3,020	

MEDIUM BACK

	Five-star black base																	
	14765	17½-20½	24½	26	26	36½-39½	2¼	45	1,855	1,950	3,250	3,620	3,775	2,170	2,480	2,815	3,150	
	Four legs																	
	14766	18½	25½	26	23	37	2½	45	1,735	1,815	3,135	3,490	3,635	2,075	2,415	2,800	3,170	
	Sled base																	
	14767	18½	25½	26	23	37	2½	45	1,745	1,840	3,145	3,505	3,675	2,090	2,430	2,810	3,180	

Standard Features

- Pneumatic height adjustment (Five-star base)
- Black tilt locking mechanism (Five-star base)
- Tension control (Five-star base)

Optional Features

- Hard floor casters, add \$105 list per chair
- Polished Aluminum Five-star base, add \$150
- Swivel pedestal base in brushed nickel finish add \$315 list per chair on pricing of five star base model
- Specify chrome or black legs
- Specify chrome or black sled base

**Brackett
Model #14761**



**Brackett
Model #14762**



**Brackett
Model #14765**



**Brackett with swivel
pedestal base**



SIDE CHAIRS

HSC Designer - HUB Design Studio

Model Number	Seat H"	W"	D"	H"	Fabric Yds.	Leather Sq.Ft.	COM	COL	Neather	Verde	Grano	Cremoso	— CDN Only — Knoll Textiles			
													1	2	3	4

HSC CHAIR ON WOOD LEGS



38801	17	25¾	24	31	2½	45	2,395	2,515	2,625	3,660	3,875	3,980	2,745	3,085	3,465	3,835
--------------	----	-----	----	----	----	----	-------	-------	-------	-------	-------	-------	-------	-------	-------	-------

HSC CHAIR ON STEEL LEGS



38802	17	25¾	24	31	2½	45	1,910	2,005	2,135	3,140	3,355	3,465	2,250	2,590	2,970	3,340
--------------	----	-----	----	----	----	----	-------	-------	-------	-------	-------	-------	-------	-------	-------	-------

HSC CHAIR ON CASTER BASE



38803	17-20	25¾	24	31-34	2½	45	1,840	1,935	2,065	3,075	3,290	3,395	2,185	2,530	2,910	3,280
--------------	-------	-----	----	-------	----	----	-------	-------	-------	-------	-------	-------	-------	-------	-------	-------

Standard features:

- Seat depth: 18"; Seat width: 20½"
- Molded foam frame with flexible foam on seat and back.
- Wood legs available in 3 species: solid yellow birch, maple or walnut and finished natural or stained with any Nienkämper standard color.
- Steel legs available in silver, black or warm white powder coat finish.
- 5 star caster base is standard in mirror polished finish with chrome carpet casters.
- Pneumatic height adjustment and back tilt locking mechanism are standard features for caster base.

Model #38801



Model #38802



Model #38803



SIDE CHAIRS

Kush Designer - MSDS Studio

Model Number	Seat H"	Arm H"	W"	D"	H"	Fabric Yds.	Leather Sq.Ft.	— CDN Only —									
								COM	COL	Neather	Verde	Grano	Creroso	Knoll	Textiles	1	2
10360	19½	25½	28	25	34	3	54	2,665	2,790	2,925	2,990	4,410	4,550	3,075	3,490	3,935	4,385

KUSH

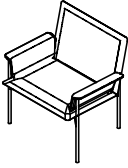

Standard features:

- Frame is constructed of FSC plywood core
- Seat & back cushions have a foam core with Dacron wrap
- Upholstered arm support with polyurethane foam
- Legs are standard in black powder coat finish





Model # 10360

Kush chair upholstered in Ecopell leather, colour Caramel EC 363.

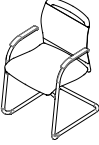

SIDE CHAIRS

Nabu™ Stacking Chair and Nabu™ Side Chair – striped mesh back Designer - Bangdesign

Model Number	Seat H"	Arm H"	W"	D"	H"	Fabric Yds.	Leather Sq. Ft.	COM	COL	Neather	Verde	Grano	Cremoso	— CDN Only — Knoll Textiles				
														1	2	3	4	
NABU™ SIDE CHAIR WITH ARMS - SLED BASE																		
	upholstered seat with striped mesh back																	
	10631	18	26	22½	22½	36½	¾	9	1,450	1,505	1,525	1,755	1,815	1,845	1,560	1,655	1,775	1,875
mesh seat with striped mesh back																		
10632	18	26	22½	22½	36½			1,470										
NABU™ STACKING CHAIR ARMLESS - SLED BASE																		
	upholstered seat with striped mesh back																	
	10605	19		23½	22	32½	¾	9	945	1,005	1,015	1,150	1,200	1,245	1,060	1,165	1,275	1,385
mesh seat with striped mesh back																		
10606	19		23½	22	32½			980										
NABU™ STACKING CHAIR ARMLESS - ON 4 LEGS																		
	upholstered seat with striped mesh back																	
	10607	19		23½	22	32½	¾	9	925	1,070	1,080	1,215	1,270	1,305	1,035	1,135	1,250	1,360
mesh seat with striped mesh back																		
10608	19		23½	22	32½			945										
NABU™ STACKING CHAIR ARMLESS - ON 4 LEGS WITH CASTERS																		
	upholstered seat with striped mesh back																	
	10633	19		23½	22	32½	¾	9	1,025	1,165	1,175	1,305	1,355	1,400	1,130	1,235	1,350	1,455
mesh seat with striped mesh back																		
10634	19		23½	22	32½			1,040										

NOTE:

White frame add - WH, Grey frame add - GR

Nabu™ Chairs (striped mesh back) are available as CAL 133 certified for an upcharge of \$125 list per chair. Certification applies to Nienkämper leathers and fabrics that have a minimum of 50% natural fibre content. COM's and COL's are subject to approval. Add the extension "-CAL" to the model number when ordering.

Standard features:

- Seat available in 29 solid mesh colors. Back available in 34 contrasting mesh stripe. Back mesh has a horizontal stripe pattern as standard created by the strong elastomer fiber woven in the mesh.
- Cushions are molded foam with 25% soy foam content
- Nabu side chair with arms on sled base available in polished chrome or black polished finish
- Arm clip in black urethane as a standard or upholstered arm cap to match the seat with an upcharge \$80 list per chair (plus addition 2 sq. ft. COL)
- Tubular steel leg or sled base is standard silver powder coat
- Back frame and arms are black as standard. White and grey optional. Custom colors available for quantities above 100.
- Models 10605 through 10608 are stackable - 6 high on floor and 10 high on dolly. Footprint 23" wide x 32" deep.
- Dolly priced separately.

Model # 10605



Model # 10631



Model # 10607



Model # 10633



SIDE CHAIRS

Nabu™ Stacking Chair and Nabu™ Side Chair – fully upholstered back Designer - Bangdesign

Model Number	Seat		Arm		D"		H"		Fabric		Leather		— CDN Only — Knoll Textiles				
	H"	W"	H"	W"	D"	H"	Yds.	Sq.Ft.	COM	COL	Neather	Verde	Grano	Cremoso	1	2	3

NABU™ SIDE CHAIR WITH ARMS - SLED BASE

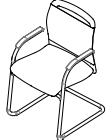
	10635	18	26	22½	22½	36½	1⅓	22	fully upholstered seat & back									1,845	1,920	1,980	2,515	2,645	2,710	2,035	2,220	2,410	2,610
	10636	18	26	22½	22½	36½	⅔	13	mesh seat with fully upholstered back									1,860	1,935	1,965	2,295	2,380	2,405	1,955	2,045	2,150	2,245

NABU™ STACKING CHAIR ARMLESS - SLED BASE

	10615	19		23½	22	32½	1⅓	22	fully upholstered seat and back									1,200	1,245	1,325	1,845	1,970	2,040	1,390	1,570	1,765	1,965
	10616	19		23½	22	32½	⅔	13	mesh seat with fully upholstered back									1,215	1,270	1,285	1,630	1,710	1,745	1,305	1,400	1,500	1,600

NABU™ STACKING CHAIR ARMLESS - ON 4 LEGS

	10617	19		23½	22	32½	1⅓	22	fully upholstered seat and back									1,175	1,230	1,305	1,830	1,955	2,030	1,360	1,540	1,740	1,940
	10618	19		23½	22	32½	⅔	13	mesh seat with fully upholstered back									1,200	1,250	1,270	1,545	1,690	1,730	1,290	1,385	1,485	1,585

NABU™ STACKING CHAIR ARMLESS - ON 4 LEGS WITH CASTERS

	10637	19		23½	22	32½	1⅓	22	fully upholstered seat and back									1,270	1,310	1,400	1,925	2,045	2,120	1,455	1,635	1,835	2,035
	10638	19		23½	22	32½	⅔	13	mesh seat with fully upholstered back									1,285	1,340	1,355	1,640	1,775	1,815	1,380	1,465	1,570	1,665

Nabu™ Chairs (fully upholstered back) are available as CAL 133 certified for an upcharge of \$125 list per chair. Certification applies to Nienkämper leathers and fabrics that have a minimum of 50% natural fibre content. COM's and COL's are subject to approval. Add the extension "-CAL" to the model number when ordering.

Standard features:





- Seat available in 29 solid mesh colors. Back available in 34 contrasting mesh stripe. Back mesh has a horizontal stripe pattern as standard created by the strong elastomer fiber woven in the mesh.
- Cushions are molded foam with 25% soy foam content
- Nabu side chair with arms on sled base available in polished chrome or black polished chrome finish
- Arm cap in black urethane as a standard or upholstered arm cap to match the seat with an upcharge \$80 list per chair (plus addition 2 sq. ft. COL)
- Tubular steel leg or sled base is standard silver powder coat
- Back frame is black as standard.
- Models 10605 through 10608 are stachable - 6 high on floor and 10 high on dolly. Footprint 23" wide x 32" deep.
- Dolly priced separately.

Model # 10615

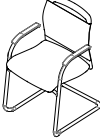

SIDE CHAIRS

Nabu™ Stacking Chair and Nabu™ Side Chair – fully upholstered mesh back Designer - Bangdesign

Model Number	Seat H"	Arm H"	W"	D"	H"	Fabric Leather		COM	COL	Neather	Verde	Grano	Cremoso	— CDN Only — KnollTextiles										
						Yds.	Sq.Ft.							1	2	3	4							
NABU™ SIDE CHAIR WITH ARMS ON - SLED BASE																								
	10639	18	26	22½	22½	36½	¾	9	upholstered seat with striped mesh back						1,535	1,600	1,615	1,850	1,915	1,935	1,640	1,745	1,855	1,965
	10640	18	26	22½	22½	36½			mesh seat with striped mesh back						1,555									
NABU™ STACKING CHAIR ARMLESS - SLED BASE																								
	10625	19		23½	22	32½	¾	9	upholstered seat with striped mesh back						990	1,030	1,065	1,180	1,230	1,275	1,095	1,200	1,310	1,420
	10626	19		23½	22	32½			mesh seat with striped mesh back						1,010									
NABU™ STACKING CHAIR ARMLESS - ON 4 LEGS																								
	10627	19		23½	22	32½	¾	9	upholstered seat with striped mesh back						970	1,095	1,105	1,280	1,290	1,340	1,075	1,180	1,290	1,400
	10628	19		23½	22	32½			mesh seat with striped mesh back						990									
NABU™ STACKING CHAIR ARMLESS - ON 4 LEGS WITH CASTERS																								
	10641	19		23½	22	32½	¾	9	upholstered seat with striped mesh back						1,060	1,190	1,205	1,340	1,385	1,435	1,170	1,270	1,385	1,490
	10642	19		23½	22	32½			mesh seat with striped mesh back						1,075									

Standard features:

- Seat available in 29 solid mesh colors. Back available in 34 contrasting mesh stripe. Back mesh has a horizontal stripe pattern as standard created by the strong elastomer fiber woven in the mesh.
- Cushions are molded foam with 25% soy foam content
- Nabu side chair with arms on sled base available in polished chrome or black polished finish
- Arm clip in black urethane as a standard or upholstered arm cap to match the seat with an upcharge \$80 list per chair (plus addition 2 sq. ft. COL)
- Tubular steel leg or sled base is standard silver powder coat
- Back frame and arms are black as standard.
- Models 10605 through 10608 are stachable - 6 high on floor and 10 high on dolly. Footprint 23" wide x 32" deep.
- Dolly priced separately.

SIDE CHAIRS

Q Chair Designer - Q Design

— CDN Only —

Model Number	Seat H"	Arm H"	W"	D"	H"	Fabric Yds.	Leather Sq. Ft.	COM	COL	Neather	Verde	Grano	Cremoso	Knoll Textiles			
														1	2	3	4

Q LOUNGE CHAIR WITH VENEER



10051	16½	21¼	31½	31	34½	2	36
--------------	-----	-----	-----	----	-----	---	----

4,115	4,320	4,315	5,295	5,490	5,590	4,390	4,665	4,965	5,265
-------	-------	-------	-------	-------	-------	-------	-------	-------	-------

Q LOUNGE CHAIR - FULLY UPHOLSTERED



10053	16½	21¼	31½	31	34½	4	72
--------------	-----	-----	-----	----	-----	---	----

3,905	4,105	4,090	5,035	5,215	5,320	4,455	5,005	5,605	6,205
-------	-------	-------	-------	-------	-------	-------	-------	-------	-------

Q SIDE CHAIR WITH VENEER



10052	18	24	27½	23	34	1½	27
--------------	----	----	-----	----	----	----	----

3,545	3,710	3,690	4,450	4,595	4,670	3,750	3,955	4,185	4,405
-------	-------	-------	-------	-------	-------	-------	-------	-------	-------

Q SIDE CHAIR - FULLY UPHOLSTERED



10054	18	24	27½	23	34	3	54
--------------	----	----	-----	----	----	---	----

3,360	3,525	3,500	4,230	4,370	4,445	3,775	4,190	4,645	5,090
-------	-------	-------	-------	-------	-------	-------	-------	-------	-------

Model # 10051



Model # 10052



Standard features:

- Moulded plywood seat & arm shell
- Soy based flexible polyurethane foam
- Maple or walnut veneer with any Nienkämper stains is available for model with veneer finish (Model #10051 & #10052)
- Q Side Chair with veneer back has only seat & arm shell but a fully upholstered back
- Polished aluminum 4-star base on glides for Q Lounge chair
- Polished aluminum cross base for Q Side chair

SIDE CHAIRS

Schultz Designer - Richard Schultz

— CDN Only —
KnollTextiles

Model Number	Seat H"	Arm H"	W"	D"	H"	Fabric Yds.	Leather Sq. Ft.	COM	COL	Verde	Grano	Cremoso	1	2	3	4
--------------	---------	--------	----	----	----	-------------	-----------------	-----	-----	-------	-------	---------	---	---	---	---

LOUNGE CHAIR

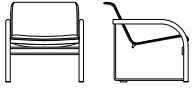

RS48	15½	21	26	29	26½	1½	28	2,900	3,045	3,900	4,175	4,280	3,110	3,310	3,540	3,760
-------------	-----	----	----	----	-----	----	----	-------	-------	-------	-------	-------	-------	-------	-------	-------

SIDE CHAIR

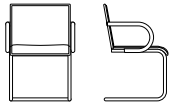

RS46-1	18	26	22 ½	23	32	1¼	20	2,830	3,005	3,635	3,845	3,920	3,010	3,180	3,370	3,555
---------------	----	----	------	----	----	----	----	-------	-------	-------	-------	-------	-------	-------	-------	-------

Model RS48
Lounge Chair



Model RS46-1
Side Chair



The tubular steel frame standard finish is mirror polished chrome. For a stainless steel frame add \$810 list per chair. When the Lounge version, Model # RS48 is upholstered in fabric, channel stitching finishes the curve between the seat and back. Leather welting in Grano or Verde leather around the perimeter of the chair is standard. Unless the color of the leather welting is specified, Nienkämper will select a suitable color.

SIDE CHAIRS

Senator® Nuvo Designer – Nienkämper

Model Number	Seat H"	Arm H"	W"	D"	H"	Fabric		COM	COL	Verde	Grano	Cremoso	— CDN Only — Knoll Textiles			
						Yds.	Sq.Ft.						1	2	3	4

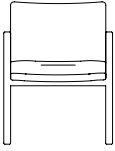

14103	17 ½	24 ½	23	25	31	1 ¼	22	2,135	2,240	2,750	3,005	3,070	2,305	2,480	2,670	2,855
--------------	------	------	----	----	----	-----	----	-------	-------	-------	-------	-------	-------	-------	-------	-------

Standard Features

- Chrome tubular sled base
- Plain upholstery



14104	17 ½	24 ½	23	25	31	1 ¼	22	3,290	3,455	3,900	4,155	4,240	3,465	3,635	3,825	4,015
--------------	------	------	----	----	----	-----	----	-------	-------	-------	-------	-------	-------	-------	-------	-------

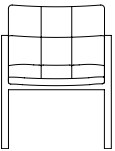

Standard Features

- Solid flat chrome sled base
- Tufted upholstery

ARMCHAIR CASTER BASE



14107	17 ½	24 ½	23	25	31	1 ¼	22	2,340	2,460	2,940	3,145	3,200	2,510	2,685	2,870	3,060
--------------	------	------	----	----	----	-----	----	-------	-------	-------	-------	-------	-------	-------	-------	-------

Standard Features

- Chrome or black base
- Chrome or black casters
- Plain upholstery

Model # 14103
Senator® Nuvo Armchair
with tubular chrome sled base



Model # 14105
Senator® Nuvo Armchair
with flat chrome sled base



Model # 14107
Senator® Nuvo Armchair Caster Base



SIDE CHAIRS

Unesco™ Designer - Robert Haussmann

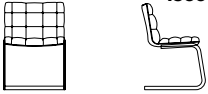
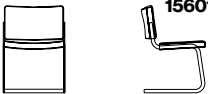
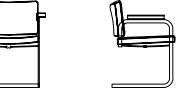
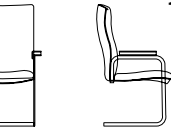
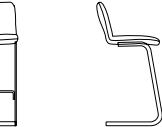
Model Number	Seat H"	Arm H"	W"	D"	H"	Fabric		— CDN Only —									
						Yds.	Sq.Ft.	Knoll				Textiles					
								COM	COL	Verde	Grano	Creoso	1	2	3	4	
SIDE CHAIR WITH BUTTON TUFTING																	
	15600	17½		20½	21	32	1½	24	2,565	2,680	3,465	3,690	3,780	2,775	2,975	3,200	3,430
LOW BACK SIDE CHAIR																	
	15601	17½		20½	22	30	1¼	20	2,380	2,490	3,125	3,335	3,390	2,560	2,725	2,915	3,105
LOW BACK																	
	15611	17½	25½	25½	22	30	1½	24	2,725	2,865	3,620	3,860	3,955	2,935	3,140	3,370	3,590
HIGH BACK																	
	15612	17½	25½	25½	22	40	2½	40	2,835	2,970	4,340	4,720	4,890	3,185	3,525	3,910	4,275
BAR STOOL																	
	15613	30		18	20	39½	1	16	2,565	2,680	3,150	3,305	3,380	2,705	2,835	2,990	3,140

Unesco – Notes and Options

Choose a brushed nickel or mirror-polished chrome finish for the oval-shaped tubular steel frame standard on all models.

Optional Features:

When ordering tufting on model numbers 15601, 15611, 15612, and 15613, add 20% to the list price and "-T" to the end of the model number.

Model #15601
Low Back Side Chair



Model #15611
Low Back



nienkämper

International Inc.

LOUNGE SEATING



LOUNGE SEATING

TABLE OF CONTENTS

Lounge Seating

55-154

32 Collection	57
Baden	58-59
Bare	60
BASS Collection	61-62
Bay	63
Belle	64
Berkley® Collection	65-70
Bern	71
Blob	72
BLOOR® Collection	73
Carlisle	74
Cocoon	75
Divvi	76
Dobi	77
Dune	78-79
Eden®	80-95
Elite	96
Expo 67	97
Godbout	98
HAB™	99
Heartbeat	100-101
Ingmar Lounge	102
Isola 8	103
J + J Studio	104
Kloud® Collection	105
Kloud® Serpentine™	106
LCS Club	107
Leaf	108
LINQ	109

LolliPOP	110
Lucerne	111
Max™	112-118
Mood Collection	119
Nordic	120
Note	121
Paris Archive	122
Patkau Twist	123
Polo	124
Pullman™	125-126
Pyramid Chair	127
Q Chair	128
Radius	129
Radius on Legs	130
Rowan Lounge	131
Satori™	132
Six® Collection	133
Spirit	134
Turnaround® Collection	135
Tuxedo™	136-137
Tuxedo Classic™	138-141
Tuxedo Cove	142-145
Tuxedo™ High Back	146-147
Vuelo Lounge	148
Wavelength®	149-150
Work:Recline	151
Yabaco	152
Yabaco	153
Zurich	154

LOUNGE SEATING

32 Collection

— CDN Only —
Knoll Textiles

Model Number	Seat H"	Arm H"	Arm W"	D"	H"	Fabric Yds.	Leather Sq.Ft.	COM	COL	Neather	Verde	Grano	Cremoso	1	2	3	4
--------------	---------	--------	--------	----	----	-------------	----------------	-----	-----	---------	-------	-------	---------	---	---	---	---

32 DINING CHAIR

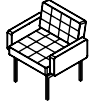

32011	18½	24	27¾	25	31½	3	54	4,695	4,935	4,990	6,375	6,670	6,790	5,110	5,530	5,975	6,425
--------------	-----	----	-----	----	-----	---	----	-------	-------	-------	-------	-------	-------	-------	-------	-------	-------

32 DINING TWO SEAT SOFA

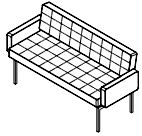

32012	18½	24	59¾	25	31½	4¾	86	6,985	7,340	7,450	9,645	10,095	10,310	7,640	8,290	9,010	9,720
--------------	-----	----	-----	----	-----	----	----	-------	-------	-------	-------	--------	--------	-------	-------	-------	-------

32 LOUNGE CHAIR

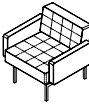

32021	16½	23	29¾	29¼	29½	4	72	5,050	5,305	5,430	7,230	7,600	7,790	5,600	6,150	6,755	7,345
--------------	-----	----	-----	-----	-----	---	----	-------	-------	-------	-------	-------	-------	-------	-------	-------	-------

32 LOUNGE TWO SEAT SOFA

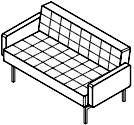

32022	16½	23	53¾	29¼	29½	6	108	7,400	7,770	7,975	10,675	11,220	11,495	8,225	9,045	9,950	10,850
--------------	-----	----	-----	-----	-----	---	-----	-------	-------	-------	--------	--------	--------	-------	-------	-------	--------

32 LOUNGE THREE SEAT SOFA

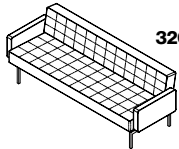

32023	16½	23	77¾	29¼	29½	8	144	8,240	8,660	9,010	12,530	13,265	13,295	9,340	10,445	11,645	12,840
--------------	-----	----	-----	-----	-----	---	-----	-------	-------	-------	--------	--------	--------	-------	--------	--------	--------

Standard Features:

- Seat depth for Dining Collection: 18½"d
- Seat depth for Lounge Collection: 22"d
- Standard with tufting on seat & back
- Plywood frame with soy based polyurethane foam
- Support frame & legs are standard in brushed aluminum finish.
- Powder coat finishes also available upon request

Model # 32011
32 dining chair upholstered in Ecopell leather, Blueberry EC700



Model # 32012
32 Dining 2 Seat Sofa





Model # 32023
32 Lounge 3 Seat Sofa

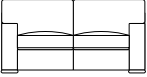
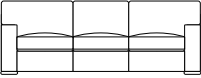

LOUNGE SEATING

Baden Designer – Nienkämper & robert haussmann

Model Number	Seat H"	Arm H"	W"	D"	H"	Fabric Yds.	Leather Sq.Ft.	COM	COL	Verde	Grano	Cremoso	— CDN Only — Knoll Textiles					
													1	2	3	4		
LOUNGE CHAIR																		
 312	18	22	38	38	33	8	110	7,230	7,605	11,375	12,440	12,885	8,330	9,430	10,640	11,830		
TWO SEAT SOFA																		
 312-2	18	22	62	38	33	10	160	9,995	10,490	15,980	17,565	18,205	11,375	12,745	14,255	15,740		
THREE SEAT SOFA																		
 312-3	18	22	87	38	33	15	210	13,135	13,775	20,990	23,045	23,885	15,190	17,255	19,515	21,750		
FOUR SEAT SOFA																		
 312-4	18	22	112	38	33	18½	260	16,335	17,145	26,060	28,625	29,655	18,875	21,420	24,210	26,965		
OTTOMAN																		
 312-5			30	30	17	3¼	52	4,045	4,245	5,985	6,490	6,700	4,490	4,945	5,430	5,915		

Baden series passes CAL 133 certified for an upcharge of \$490 list per chair, \$975 list per two seater sofa, \$1,460 list per three seat sofa, \$1,945 list per four seat sofa, and \$485 list per ottoman. Certification applies to Nienkämper leathers and fabrics that have a minimum of 50% natural fibre content. COM's and COL's are subject to approval. Add the extension -CAL to the model number when ordering.

When COM is lightweight, a welting detail is added to the perimeter of the seat and back cushions. Allow 5% additional yardage of COM to accommodate welting details.

When upholstered in leather, seat and back cushions have a foam core wrapped in a down and feather combination.

When upholstered in COM, seat and back cushions have a foam core wrapped in Dacron.

All seat and back cushions are loose.

Two base options are available. Radius feet, see photo on page 58, are offered ebonized as standard. Angled wood feet, see photo on page 58, are offered ebonized as standard. Both Radius and Angled feet are available in standard Nienkämper stains, see page 12 for a listing. To match custom stains add \$600 list per stain color.

Model #312



Model #312-2



Model #312-3



LOUNGE SEATING

Baden Designer – Nienkämper & robert haussmann

— CDN Only —

Model Number	Seat H"	Arm H"	W"	D"	H"	Fabric Yds.	Leather Sq.Ft.	COM	COL	Verde	Grano	Cremoso	Knoll Textiles			
													1	2	3	4

SIX SEAT L-SHAPED SOFA

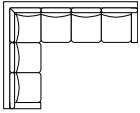

312-6	18	22	119	94	33	22	360	25,555	26,830	39,030	42,575	44,005	28,585	31,600	34,925	38,200
--------------	----	----	-----	----	----	----	-----	--------	--------	--------	--------	--------	--------	--------	--------	--------

SEVEN SEAT L-SHAPED SOFA

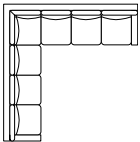

312-7	18	22	119	119	33	28	410	29,285	30,745	44,635	48,675	50,285	33,140	36,990	41,210	45,380
--------------	----	----	-----	-----	----	----	-----	--------	--------	--------	--------	--------	--------	--------	--------	--------

EIGHT SEAT L-SHAPED SOFA

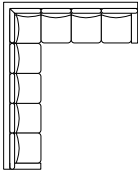

312-8	18	22	119	144	33	30	460	32,965	34,615	50,180	54,715	56,530	37,090	41,210	45,740	50,210
--------------	----	----	-----	-----	----	----	-----	--------	--------	--------	--------	--------	--------	--------	--------	--------

Baden series passes CAL 133 certified for an upcharge of \$2,915 list for six seat, \$3,400 list for seven seat, and \$3,885 list for eight seat. Certification applies to Nienkämper leathers and fabrics that have a minimum of 50% natural fibre content. COM's and COL's are subject to approval. Add the extension -CAL to the model number when ordering.

When COM is lightweight, a welting detail is added to the perimeter of the seat and back cushions. Allow 5% additional yardage of COM to accommodate welting details.

When upholstered in leather, seat and back cushions have a foam core wrapped in a down and feather combination.

When upholstered in COM, seat and back cushions have a foam core wrapped in Dacron.

All seat and back cushions are loose.

Two base options are available. Radius feet, see photo below left, are offered ebonized as standard. Angled wood feet, see photo below right, are offered ebonized as standard. Both Radius and Angled feet are available in standard Nienkämper stains, see page 12 for a listing. To match custom stains add \$600 list per stain color.

Radius Foot



Angled Foot

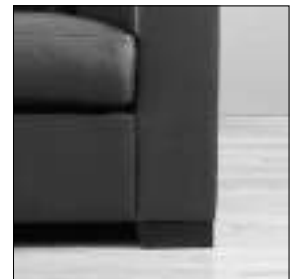

LOUNGE SEATING

Bare Designer - Evan bare

Model Number	Seat H"	W"	D"	H"	Fabric Yds.	Leather Sq.Ft.	COM	COL	Neather	Verde	Grano	Cremoso	— CDN Only — Knoll Textiles			
													1	2	3	4

BARE CHAIR

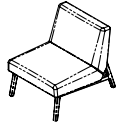

10321	16¾	26	33	29½	3¾	68
				Seat	1¼	23
				Back	2½	45

4,620	4,865	4,995	6,690	7,025	7,205	5,140	5,655	6,225	6,780
-------	-------	-------	-------	-------	-------	-------	-------	-------	-------

BARE TWO SEAT SOFA

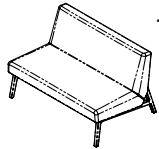

10322	16¾	50	33	29½	5¾	104
				Seat	2¼	41
				Back	3½	63

6,230	6,545	6,915	9,335	9,870	10,130	7,025	7,815	8,680	9,535
-------	-------	-------	-------	-------	--------	-------	-------	-------	-------

Model # 10321
Bare Chair



Model # 10322
Bare Two Seat Sofa



Standard Features:

- Seat depth: 21"d
- Plywood frame with soy based polyurethane foam.
- Solid maple or walnut legs are standard in ebonized finish but also available in any Nienkämper stains.
- Custom stain is available with upcharge.

LOUNGE SEATING

BASS Collection Designer - busk + hertzog

Model Number	Seat H"	Arm H"	W"	D"	H"	Fabric		COM	COL	Verde	Grano	Cremoso	— CDN Only — Knoll Textiles			
						Yds.	Sq.Ft.						1	2	3	4

BASS LOW BACK SMALL LOUNGE CHAIR

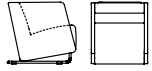

12011	17	26½	27	29	26½	5	90										
		seat & back				3	54										
		arms				3½	63										

3,290	3,460	5,950	6,500	6,775	3,970	4,665	5,420	6,160
-------	-------	-------	-------	-------	-------	-------	-------	-------

BASS LOW BACK LARGE LOUNGE CHAIR

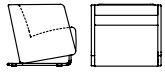

12012	17	26½	32	29	26½	6½	99										
		seat & back				3	54										
		arms				3½	63										

3,405	3,590	6,310	6,915	7,205	4,300	5,200	6,175	7,140
-------	-------	-------	-------	-------	-------	-------	-------	-------

BASS LOW BACK 2 SEATER SOFA

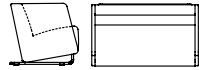

12013	17	26½	59	29	26½	7½	135										
		seat & back				5	90										
		arms				3½	63										

4,565	4,795	7,860	8,540	8,885	5,595	6,615	7,755	8,870
-------	-------	-------	-------	-------	-------	-------	-------	-------

BASS LOW BACK 3 SEATER SOFA

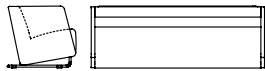

12014	17	26½	82	29	26½	9½	171										
		seat & back				7	126										
		arms				3½	63										

6,335	6,665	10,050	10,800	11,170	7,640	8,950	10,380	11,795
-------	-------	--------	--------	--------	-------	-------	--------	--------

Standard features:

- Frame is constructed of Solid Maple and FSC Hardwood Plywood with soy-based Polyurethane
- Foam covered with Fortrel
- Polished chrome tubular base

Model # 12011



Model # 12013



Model # 12014



LOUNGE SEATING

BASS Collection Designer - busk + hertzog

— CDN Only —
Knoll Textiles

Model Number	Seat H"	Arm H"	W"	D"	H"	Fabric		COM	COL	Verde	Grano	Cremoso	1	2	3	4
--------------	---------	--------	----	----	----	--------	--	-----	-----	-------	-------	---------	---	---	---	---

BASS HIGH BACK LARGE LOUNGE CHAIR

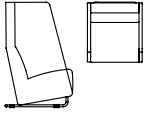

12024	17	46½	32	29	46½	7	126						4,700	4,945	8,105	8,810	9,165	5,665	6,630	7,685	8,735	
		seat & back					4½	81														
		arms					5⅓	96														

BASS HIGH BACK 2 SEATER SOFA

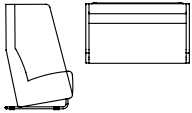

12022	17	46½	59	29	46½	11	198						5,930	6,230	11,210	12,325	12,870	7,445	8,960	10,620	12,255	
		seat & back					6¾	122														
		arms					5⅓	96														

BASS HIGH BACK 3 SEATER SOFA

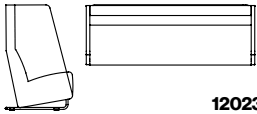

12023	17	46½	82	29	46½	13	234						7,795	8,190	14,080	15,375	16,030	9,580	11,375	13,325	15,265	
		seat & back					9	162														
		arms					5⅓	96														

Model # 12022



Model # 12023



Standard features:

- Frame is constructed of Solid Maple and FSC Hardwood Plywood with soy-based Polyurethane Foam covered with Fortrel
- Polished chrome tubular base

LOUNGE SEATING

Bay Designer - busk + hertzog

— CDN Only —

Model Number	Seat H"	W"	D"	H"	Fabric		COM	COL	Neather	Verde	Grano	Cremoso	Knoll Textiles			
					Yds.	Sq.Ft.							1	2	3	4

BAY CHAIR WITH UPHOLSTERED BASE



10520	16	26	27¼	26¼	3¼	59													
Fully upholstered																			
10521	Contrasting Fabric																		
	Seat					1¼													
	Base					1½													
10522	Contrasting Leather																		
	Seat					32													
	Base					27													

Model # 10521



Standard features:







- Seat with plywood shell & soy based flexible polyurethane foam
- Base in soy based rigid polyurethane
- Base with plastic glides at bottom.

LOUNGE SEATING

Beam Collection - Designer - Kenny Nguyen

FULL SURROUNDING CONFIGURATIONS

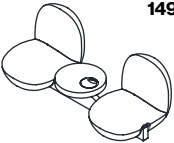
— CDN Only —

Model Number	Seat H"	W"	D"	H"	Yds.	Sq. Ft.	COM	COL	Neather	Verde	Grano	Cremoso	Knoll Textiles				
													1	2	3	4	
BEAM LOUNGE CHAIR																	
	14931	16½	28¾	39¾	31	4.5	100	3,340	3,510	3,750	6,110	6,510	7,010	3,625	3,910	4,215	4,530
BEAM 2 SEAT																	
	14932	16½	58¾	39¾	31	9	200	6,680	7,015	7,500	12,215	13,015	14,015	7,250	7,815	8,430	9,060
BEAM 3 SEAT																	
	14933	16½	89	39¾	31	13.5	300	10,020	10,525	11,250	18,325	19,525	21,025	10,875	11,725	12,640	13,585
BEAM CHAIR WITH TABLE																	
	14935	16½	53¾	39¾	31	4.5	100	5,525	5,805	5,935	8,405	8,805	9,305	5,810	6,095	6,400	6,715
BEAM 2 SEAT WITH END TABLE																	
	14936	16½	84	39¾	31	9	200	8,865	9,310	9,685	14,510	15,310	16,310	9,435	10,000	10,615	11,245
BEAM 2 SEAT WITH MID TABLE																	
	14937	16½	84	39¾	31	9	200	9,065	9,520	9,885	14,720	15,520	16,520	9,635	10,200	10,815	11,445
BEAM 3 SEAT WITH END TABLE																	
	14938	16½	114¼	39¾	31	13.5	300	12,205	12,820	13,435	20,620	21,820	23,320	13,060	13,910	14,825	15,770

Model # 14931

Beam Lounge Chair
 Back upholstered in
 Maharam Nico, 022 Jousting
 Seat upholstered in
 Maharam Nico, 021 Rosin

Model # 14937

Beam Lounge Chair
 Upholstered in
 Maharam Nico, 022 Jousting
 Rift cut, creamy walnut veneer table
 and beam finish



Standard features:

- Constructed from high resilient foam molded over wood frame
- Structural wood beam available in all standard Veneer, stain and finish
- Tables are standard with courtesy 2 power unit.

LOUNGE SEATING

Belle Lounge Designer - busk + hertzog

Model Number	Seat H"	W"	D"	H"	Fabric		COM	COL	Neather	Verde	Grano	Cremoso	— CDN Only — Knoll Textiles			
					Yds.	Sq.Ft.							1	2	3	4

BELLE LOUNGE



37101	16	33	28	30	4	72	3,005	3,160	3,370	4,985	5,330	5,505	3,555	4,110	4,705	5,305
	Inside Back & Seat Cushion				2	36										
	Outside Back and Bottom				2½	45										

Standard features:

- Frame: Durable construction with steel frame covered with molded foam
- Cushion: High resistant and flexible foam on seat cushion
- Base: Swivel brushed metal disc base as standard, fixed disc base is also an option.
- Base Finishes: Brushed black, brushed silver and powder coat finishes also available.

Model # 37101



LOUNGE SEATING

The Berkley® Collection Designer - Nienkämper

— CDN Only —

Model Number	Seat H"	W"	D"	H"	Fabric Yds.	Leather Sq.Ft.	COM	COL	Neather	Verde	Grano	Cremoso	Knoll Textiles			
													1	2	3	4

SINGLE ELEMENT

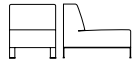

Model #	Seat H"	W"	D"	H"	Fabric Yds.	Leather Sq.Ft.	COM	COL	Neather	Verde	Grano	Cremoso	1	2	3	4	
13410_	16	24	35	27½													
/1 Armless with metal legs					3 ¾	60	3,145	3,380	3,390	4,515	4,890	5,040	3,665	4,180	4,755	5,305	
/2 8 Angled arm					5 ½	88	4,040	4,335	4,560	6,940	7,710	8,025	4,800	5,555	6,380	7,205	
/3 10 Angled arm					6 ¼	100	4,160	4,470	4,695	7,100	7,845	8,155	5,025	5,890	6,825	7,755	
/4 8 Straight arm with leg					5 ½	88	5,415	5,810	5,865	7,855	8,515	8,765	6,170	6,925	7,755	8,575	
/5 10 Straight arm with leg					6 ¼	100	5,475	5,870	5,920	7,915	8,565	8,820	6,340	7,195	8,135	9,070	

Note: Width measurements do not include arms.

TWO SEAT ELEMENT

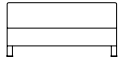

Model #	Seat H"	W"	D"	H"	Fabric Yds.	Leather Sq.Ft.	COM	COL	Neather	Verde	Grano	Cremoso	1	2	3	4	
13401_	16	48	35	27½													
/1 Armless with metal legs					3 ¾	60	4,075	4,380	4,500	6,380	6,980	7,215	4,595	5,110	5,680	6,235	
/2 8 Angled arm					5 ½	88	4,965	5,335	5,655	8,795	9,800	10,210	5,725	6,480	7,310	8,125	
/3 10 Angled arm					6 ¼	100	5,100	5,485	5,795	8,945	9,950	10,360	5,965	6,815	7,760	8,690	
/4 8 Straight arm with leg					5 ½	88	6,340	6,805	6,950	9,715	10,615	10,970	7,100	7,855	8,680	9,505	
/5 10 Straight arm with leg					6 ¼	100	6,395	6,890	7,005	9,785	10,665	11,020	7,265	8,120	9,065	9,995	

Note: Width measurements do not include arms.

LARGE TWO SEAT ELEMENT

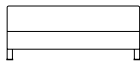

Model #	Seat H"	W"	D"	H"	Fabric Yds.	Leather Sq.Ft.	COM	COL	Neather	Verde	Grano	Cremoso	1	2	3	4	
13402_	16	60	35	27½													
/1 Armless with metal legs					4 ¼	68	4,350	4,675	4,825	6,950	7,650	7,915	4,935	5,525	6,160	6,795	
/2 8 Angled arm					6	96	5,245	5,625	5,995	9,385	10,470	10,900	6,080	6,900	7,805	8,695	
/3 10 Angled arm					6 ¾	108	5,375	5,785	6,125	9,525	10,615	11,045	6,310	7,230	8,250	9,255	
/4 8 Straight arm with leg					6	96	6,615	7,115	7,310	10,305	11,275	11,640	7,450	8,270	9,180	10,075	
/5 10 Straight arm with leg					6 ¾	108	6,685	7,180	7,345	10,365	11,320	11,725	7,620	8,545	9,565	10,565	

Note: Width measurements do not include arms.

Berkley Collection passes CAL 133 certified for an upcharge of \$440 list per single element, \$870 list per 2 seat element, and \$1,095 list per large 2 seat element. Certification applies to Nienkämper leathers and fabrics that have a minimum of 50% natural fibre content. COM's and COL's are subject to approval. Add the extension -CAL to the model number when ordering.

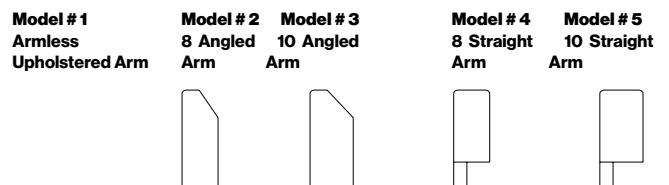

LOUNGE SEATING

The Berkley® Collection Designer – Nienkämper

— CDN Only —
Knoll Textiles

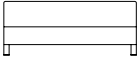
Model Number	Seat H"	W"	D"	H"	Fabric Yds.	Leather Sq. Ft.	COM	COL	Neather				Verde				Grano				Cremoso			
									1	2	3	4	1	2	3	4	1	2	3	4	1	2	3	4
THREE SEAT ELEMENT																								
	13403_	16	72	35	27½																			
	/1	Armless with metal legs				5	80	4,715	5,085	5,280	7,795	8,595	8,915	5,405	6,100	6,855	7,595							
	/2	8 Angled arm				6¾	108	5,605	6,015	6,455	10,205	11,410	11,920	6,540	7,465	8,480	9,495							
	/3	10 Angled arm				7¾	120	5,745	6,170	6,575	10,350	11,545	12,040	6,765	7,790	8,910	10,010							
	/4	8 Straight arm with leg				6¾	108	6,980	7,485	7,750	11,125	12,210	12,645	7,910	8,840	9,860	10,865							
	/5	10 Straight arm with leg				7½	120	7,050	7,560	7,800	11,185	12,270	12,715	8,080	9,110	10,245	11,355							

Note: Width measurements do not include arms.

LARGE THREE SEAT ELEMENT

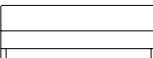
	13404_	16	84	35	27½																	
	/1	Armless with metal legs				5¾	92	5,195	5,575	5,825	8,735	9,645	10,010	5,985	6,775	7,645	8,490					
	/2	8 Angled arm				7½	120	6,090	6,530	6,985	11,130	12,470	13,010	7,120	8,150	9,290	10,395					
	/3	10 Angled arm				8¼	132	6,215	6,685	7,130	11,280	12,610	13,155	7,345	8,480	9,730	10,955					
	/4	8 Straight arm with leg				7½	120	7,450	8,015	8,305	12,050	13,265	13,765	8,480	9,515	10,650	11,760					
	/5	10 Straight arm with leg				8¼	132	7,525	8,070	8,350	12,115	13,325	13,815	8,660	9,795	11,045	12,265					

Note: Width measurements do not include arms.

Berkley Collection passes CAL 133 certified for an upcharge of \$1,305 list per 3 seat element, and \$1,535 per large 3 seat element. Certification applies to Nienkämper leathers and fabrics that have a minimum of 50% natural fibre content. COM's and COL's are subject to approval. Add the extension -CAL to the model number when ordering.

Model # 1
Armless Upholstered Arm

Model # 2
8 Angled Arm

Model # 3
10 Angled Arm

Model # 4
8 Straight Arm

Model # 5
10 Straight Arm



The Berkley Collection is a Nienkämper classic in its contemporary style and simplicity of line. This is a collection that is elegant yet generous in proportions. Berkley works well in public spaces, executive lounges, lobbies, and residences.

Frame:
Solid maple and plywood construction.

Seat and Back:
The seat and back are polyurethane foam covered in Fortrel®. Upholstered in leather or fabric. Yardages are for plain non-directional fabrics. Fabrics are railroaded.

Arms:
Two arm options are available, Angled and Straight. The Angled arm carries to the floor. The Straight arm rests on an aluminum base.

Base:
On models with Angled arms, the base is solid maple runners painted matte black. Aluminum bases are available in a brushed, polished, or painted finish.



LOUNGE SEATING

The Berkley® Collection Designer - Nienkämper

— CDN Only —

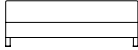
Model Number	Seat H"	W"	D"	H"	Fabric Yds.	Leather Sq.Ft.	COM	COL	Neather	Verde	Grano	Cremoso	Knoll Textiles						
													1	2	3	4			
FOUR SEAT ELEMENT																			
	13405_	16	96	35	27½														
	/1	Armless with metal legs			6¼	100	5,810	6,240	6,505	9,645	10,660	11,070	6,675	7,530	8,470	9,405			
	/2	8 Angled arm			8	128	6,700	7,190	7,660	12,055	13,495	14,045	7,805	8,905	10,110	11,300			
	/3	10 Angled arm			8 ¾	140	6,860	7,340	7,805	12,205	13,620	14,170	8,060	9,260	10,580	11,885			
	/4	8 Straight arm with leg			8	128	8,070	8,675	8,975	12,985	14,290	14,795	9,175	10,275	11,480	12,665			
	/5	10 Straight arm with leg			8 ¾	140	8,130	8,740	9,030	13,050	14,350	14,850	9,335	10,540	11,860	13,165			

Note: Width measurements do not include arms.

LARGE FOUR SEAT ELEMENT

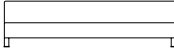
	13418_	16	108	35	27½														
	/1	Armless with metal legs			7	112	6,480	6,945	7,240	10,760	11,895	12,345	7,445	8,410	9,460	10,510			
	/2	8 Angled arm			8¾	140	7,360	7,910	8,425	13,195	14,740	15,340	8,565	9,765	11,090	12,390			
	/3	10 Angled arm			9½	152	7,515	8,050	8,550	13,325	14,860	15,480	8,810	10,110	11,530	12,940			
	/4	8 Straight arm with leg			8¾	140	8,740	9,385	9,715	14,110	15,515	16,090	9,940	11,140	12,460	13,765			
	/5	10 Straight arm with leg			9½	152	8,790	9,450	9,780	14,160	15,580	16,140	10,100	11,405	12,840	14,255			

Note: Width measurements do not include arms.

Berkley Collection passes CAL 133 certified for an upcharge of \$1,760 list per 4 seat element, and \$1,980 per large 4 seat element. Certification applies to Nienkämper leathers and fabrics that have a minimum of 50% natural fibre content. COM's and COL's are subject to approval. Add the extension -CAL to the model number when ordering.

The Berkley Collection is a Nienkämper classic in its contemporary style and simplicity of line. This is a collection that is elegant yet generous in proportions. Berkley works well in public spaces, executive lounges, lobbies, and residences.

Frame:

Solid maple and plywood construction.

Seat and Back:

The seat and back are polyurethane foam covered in Fortrel®. Upholstered in leather or fabric. Yardages are for plain non-directional fabrics. Fabrics are railroaded.

Arms:

Two arm options are available, Angled and Straight. The Angled arm carries to the floor. The Straight arm rests on an aluminum base.

Base:

On models with Angled arms, the base is solid maple runners painted matte black. Aluminum bases are available in a brushed, polished, or painted finish.

Model # 1
Armless
Upholstered Arm



Model # 2
8 Angled
Arm



Model # 3
10 Angled
Arm



Model # 4
8 Straight
Arm



Model # 5
10 Straight
Arm



LOUNGE SEATING

The Berkley® Collection Designer – Nienkämper

— CDN Only —

Model Number	Seat H"	W"	D"	H"	Fabric Yds.	Leather Sq. Ft.	COM	COL	Neather	Verde	Grano	Cremoso	Knooll Textiles			
													1	2	3	4

FIVE SEAT ELEMENT

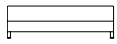

13419_	16	120	35	27½															
/1	Armless with metal legs				7 ¾	139½	7,135	7,660	8,020	11,895	13,155	13,640	8,210	9,275	10,445	11,600			
/2	8 Angled arm				9 ½	152	8,030	8,630	9,170	14,310	15,975	16,630	9,335	10,645	12,075	13,495			
/3	10 Angled arm				10 ¼	164	8,160	8,775	9,310	14,445	16,120	16,780	9,575	10,980	12,530	14,055			
/4	8 Straight arm with leg				9 ½	152	9,410	10,105	10,475	15,250	16,780	17,385	10,720	12,020	13,465	14,870			
/5	10 Straight arm with leg				10 ¼	164	9,465	10,175	10,530	15,290	16,830	17,445	10,880	12,285	13,835	15,365			

Note: Width measurements do not include arms.

BENCH

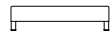

13411	16	48	24	16	2 ¼	32	2,110	2,250	2,320	3,340	3,635	3,775	2,410	2,720	3,065	3,395			
13412	16	60	24	16	2 ¾	40	2,160	2,310	2,405	3,545	3,900	4,050	2,540	2,920	3,335	3,740			
13413	16	72	24	16	3 ¼	48	2,520	2,710	2,800	4,055	4,465	4,610	2,970	3,420	3,910	4,390			
13414	16	84	24	16	3 ¾	56	3,255	3,505	3,570	4,955	5,385	5,565	3,770	4,285	4,855	5,415			
13415	16	96	24	16	4¼	64	3,445	3,690	3,775	5,280	5,760	5,940	4,030	4,610	5,250	5,895			

Note: Width measurements do not include arms.

Berkley Collection passes CAL 133 certified for an upcharge of \$2,195 list per 5 seat element, \$505 list per 48 bench, \$630 list per 60 bench, \$760 list per 72 bench, \$885 list per 84 bench, and \$1010 list per 96 bench. Certification applies to Nienkämper leathers and fabrics that have a minimum of 50% natural fibre content. COM's and COL's are subject to approval. Add the extension -CAL to the model number when ordering.

The Berkley Collection is a Nienkämper classic in its contemporary style and simplicity of line. This is a collection that is elegant yet generous in proportions. Berkley works well in public spaces, executive lounges, lobbies, and residences.

Frame:

Solid maple and plywood construction.

Seat and Back:

The seat and back are polyurethane foam covered in Fortrel®. Upholstered in leather or fabric. Yardages are for plain non-directional fabrics. Fabrics are railroaded.

Arms:

Two arm options are available, Angled and Straight. The Angled arm carries to the floor. The Straight arm rests on an aluminum base.

Base:

On models with Angled arms, the base is solid maple runners painted matte black. Aluminum bases are available in a brushed, polished, or painted finish.

Model # 1	Model # 2	Model # 3	Model # 4	Model # 5
Armless Upholstered Arm	8 Angled Arm	10 Angled Arm	8 Straight Arm	10 Straight Arm

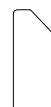

LOUNGE SEATING

The Berkley® Collection Designer - Nienkämper

— CDN Only —

Model Number	Seat H"	W"	D"	H"	Fabric Yds.	Leather Sq. Ft.	COM	COL	Neather	Verde	Grano	Cremoso	Knoll Textiles			
													1	2	3	4

LEFT CORNER ELEMENTS



One Seat Left Element

13421_ 16 23½-58½ 35 27½

/1 Armless with metal legs	4¼	68	3,545	3,805	4,025	6,140	6,860	7,110	4,130	4,710	5,355	5,995
/2 8 Angled arm	5	80	3,965	4,270	4,585	7,300	8,135	8,485	4,660	5,345	6,105	6,850
/3 10 Angled arm	5½	86	4,050	4,350	4,650	7,340	8,225	8,560	4,810	5,565	6,390	7,215
/4 8 Straight arm with leg	5	80	4,670	5,010	5,235	7,750	8,550	8,865	5,355	6,040	6,795	7,540
/5 10 Straight arm with leg	5½	86	4,700	5,050	5,260	7,770	8,570	8,890	5,460	6,220	7,050	7,865

Note: Width measurements do not include arms. One arm and one element must be specified with each element ordered



Two Seat Left Element

13422_ 16 47¼-82½ 35 27½

/1 Armless with metal legs	5¾	92	4,470	4,805	5,110	8,000	8,945	9,305	5,265	6,050	6,920	7,780
/2 8 Angled arm	6½	104	4,905	5,280	5,685	9,135	10,240	10,685	5,805	6,695	7,680	8,645
/3 10 Angled arm	7	110	4,990	5,365	5,755	9,195	10,310	10,755	5,950	6,910	7,970	9,010
/4 8 Straight arm with leg	6½	104	5,605	6,015	6,330	9,595	10,650	11,070	6,500	7,400	8,375	9,340
/5 10 Straight arm with leg	7	110	5,625	6,065	6,365	9,620	10,665	11,085	6,590	7,550	8,610	9,650

Note: Width measurements do not include arms. One arm and one element must be specified with each element ordered

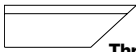

Three Seat Left Element

13423_ 16 71½-106½ 35 27½

/1 Armless with metal legs	7¼	116	5,105	5,490	5,925	9,555	10,730	11,200	6,110	7,100	8,200	9,275
/2 8 Angled arm	8	128	5,560	5,970	6,490	10,695	12,040	12,590	6,665	7,760	8,970	10,160
/3 10 Angled arm	8½	134	5,620	6,040	6,555	10,760	11,925	12,650	6,790	7,965	9,240	10,515
/4 8 Straight arm with leg	8	128	6,240	6,710	7,135	11,165	12,440	12,960	7,340	8,445	9,645	10,845
/5 10 Straight arm with leg	8½	134	6,280	6,740	7,165	11,185	12,490	12,985	7,450	8,625	9,905	11,170

Note: Width measurements do not include arms. One arm and one element must be specified with each element ordered

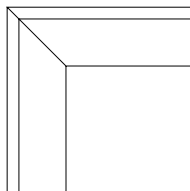
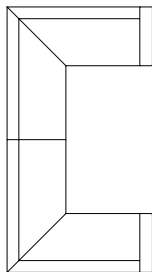

Model # 1 Armless Upholstered Arm
Model # 2 8 Angled Arm
Model # 3 10 Angled Arm
Model # 4 8 Straight Arm
Model # 5 10 Straight Arm



Yardages are for plain non-directional fabrics. Fabrics are railroaded. COM must be approved before placing an order.

LOUNGE SEATING

The Berkley® Collection Designer – Nienkämper

— CDN Only —
Knoll Textiles

Model Number	Seat H"	W"	D"	H"	Fabric Yds.	Leather Sq. Ft.	COM	COL	Neather	Verde	Grano	Cremoso	1	2	3	4
--------------	---------	----	----	----	-------------	-----------------	-----	-----	---------	-------	-------	---------	---	---	---	---

RIGHT CORNER ELEMENTS



One Seat Right Element

13424_ 16 23½-58½ 35 27½

/1 Armless with metal legs	4¼	68	3,545	3,805	4,025	6,140	6,860	7,110	4,130	4,710	5,355	5,995
/2 8 Angled arm	5	80	3,965	4,270	4,585	7,300	8,135	8,485	4,660	5,345	6,105	6,850
/3 10 Angled arm	5½	86	4,050	4,350	4,650	7,340	8,225	8,560	4,810	5,565	6,390	7,215
/4 8 Straight arm with leg	5	80	4,670	5,010	5,235	7,750	8,550	8,865	5,355	6,040	6,795	7,540
/5 10 Straight arm with leg	5½	86	4,700	5,050	5,260	7,770	8,570	8,890	5,460	6,220	7,050	7,865



Two Seat Right Element

13425_ 16 47½-82½ 35 27½

/1 Armless with metal legs	5¾	92	4,470	4,805	5,110	8,000	8,945	9,305	5,265	6,050	6,920	7,780
/2 8 Angled arm	6½	104	4,905	5,280	5,685	9,135	10,240	10,685	5,805	6,695	7,680	8,645
/3 10 Angled arm	7	110	4,990	5,365	5,755	9,195	10,310	10,755	5,950	6,910	7,970	9,010
/4 8 Straight arm with leg	6½	104	5,605	6,015	6,330	9,595	10,650	11,070	6,500	7,400	8,375	9,340
/5 10 Straight arm with leg	7	110	5,625	6,065	6,365	9,620	10,665	11,085	6,590	7,550	8,610	9,650

Note: Width measurements do not include arms. One arm and one element must be specified with each element ordered



Three Seat Right Element

13426_ 16 71½-106½ 35 27½

/1 Armless with metal legs	7¼	116	5,105	5,490	5,925	9,555	10,730	11,200	6,110	7,100	8,200	9,275
/2 8 Angled arm	8	128	5,560	5,970	6,490	10,695	12,040	12,590	6,665	7,760	8,970	10,160
/3 10 Angled arm	8½	134	5,620	6,040	6,555	10,760	11,925	12,650	6,790	7,965	9,240	10,515
/4 8 Straight arm with leg	8	128	6,240	6,710	7,135	11,165	12,440	12,960	7,340	8,445	9,645	10,845
/5 10 Straight arm with leg	8½	134	6,280	6,740	7,165	11,185	12,490	12,985	7,450	8,625	9,905	11,170

Note: Width measurements do not include arms. One arm and one element must be specified with each element ordered



Bench w/8 Arm

13416 48 32 21½ 4 72 **4,575** **4,800** **4,955** **6,690** **7,385** **7,610** **5,125** **5,670** **6,275** **6,875**

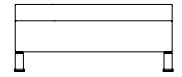

Bench w/10 Arm

13417 48 34 21½ 4 72 4,645 4,870 5,010 6,745 7,450 7,690 5,195 5,745 6,345 6,940

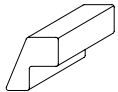

Movable Cushion





13430 24 12 12 1 18 **900** **910** **1,015** **1,435** **1,615** **1,665** **1,040** **1,180** **1,320** **1,480**

Model # 1 Armless Upholstered Arm Model # 2 8 Angled Arm Model # 3 10 Angled Arm Model # 4 8 Straight Arm Model # 5 10 Straight Arm

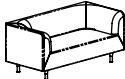
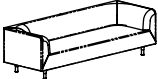

LOUNGE SEATING

Bern Designer – Nienkämper

Model Number	Seat		Arm H"	W"	D"	H"	Fabric Yds.	Leather Sq. Ft.	COM	COL	Neather	Verde	Grano	Cremoso	— CDN Only — Knoll Textiles			
	H"	H"													1	2	3	4
SMALL LOUNGE CHAIR																		
	10160	16¼	27¾	33	29	27¾	4	72	3,930	4,140	4,340	6,135	6,520	6,705	4,480	5,030	5,635	6,230
LARGE LOUNGE CHAIR																		
	10161	16¼	27¾	37	29	27¾	4½	81	4,165	4,380	4,610	6,615	7,050	7,265	4,790	5,405	6,090	6,760
TWO SEAT SOFA																		
	10162	16¼	27¾	61	29	27¾	6	108	5,790	6,085	6,370	9,070	9,340	9,920	6,610	7,440	8,345	9,235
THREE SEAT SOFA																		
	10163	16¼	27¾	85	29	27¾	7	126	7,540	7,920	8,230	11,410	11,685	12,460	8,505	9,465	10,525	11,570
THROW CUSHION																		
	10164			12	12		½	9	285	295	330	570	640	685	360	430	500	575

Standard Features:

- Seat depth: 22" d
- Frame is constructed of Solid Maple and Plywood with soy based Polyurethane Foam covered with Fortrel.
- Square tubular or round legs made of cast aluminum are available in brushed finish. A polished finish is available for an upcharge of \$140 list per chair or sofa.

Model # 10161

Bern Lounge Chair upholstered in Cremoso leather, Black CM795





Model # 10163
Bern 3 Seat Sofa



LOUNGE SEATING

Blob™ Designer - karim rashid

												— CDN Only —						
Model Number	Seat H"	W"	D"	H"	Fabric		COM	COL	Verde	Grano	Cremoso	Knoll Textiles						
					Yds.	Sq. Ft.						1	2	3	4			
BLOB																		
	1490__	16	26	32½	29													
	(Model #1)	Fully Upholstered				2¾	50	2,095	2,190	3,585	3,965	4,140	2,480	2,860	3,275	3,685		
	(Model #4)	Contrasting fabric		sides		1½		2,095					2,305	2,510	2,740	2,960		
	(Model #5)	Contrasting leather		sides		27		2,190	3,585	3,965	4,140							
				seat/back		1½												
				seat/back		27												
BLOB TWO SEAT SOFA																		
	14908	16	52	32½	29	4¾	86	3,735	3,930	5,810	6,355	6,575	4,390	5,040	5,765	6,470		
	14909	Contrasting fabric		sides		1½		3,735				3,945	4,150	4,380	4,600			
	14910	Contrasting leather		sides		27		3,930	5,810	6,355	6,575							
				seat/back		3¼												
				seat/back		59												
BLOB THREE SEAT SOFA																		
	14921	16	78	32½	29	6½	117	5,205	5,475	8,060	8,810	9,100	6,135	7,060	8,080	9,085		
	14922	Contrasting fabric		sides		1½		5,205				5,415	5,615	5,840	6,065			
	14923	Contrasting leather		sides		27		5,475	8,060	8,810	9,100							
				seat/back		90												

The curvaceous shape and soft molded foam of the Blob is conducive to fabrics with some stretch and minimum pattern.

When upholstered in two different fabrics or leathers, use the COM price and ship your fabric yardage or leather square footage to Nienkämper. See page 6 for COM and COL details.

Seams can have matching or contrasting stitching. Matching or contrasting welting detail can also be specified.

*For patterned or directional fabrics please contact Customer Service at 800.668.9318 for yardages.

Fabric to be upholstered on Blob requires approval from Nienkämper's factory. Please contact customer service at 800 668 9318 for our fabric approval list.

Model #14904
Contrasting fabric



Model #14904
Contrasting fabric



LOUNGE SEATING

Bloor® Collection Designer – Nienkämper

Model Number	Seat Arm			D"	H"	Fabric Yds.	Leather Sq.Ft.	COM	COL	Verde	Grano	Cremoso	— CDN Only — Knoll Textiles			
	H"	H"	W"										1	2	3	4

CHAIR

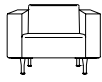

13481	16	24	34	29	27½	4	74	4,035	4,340	6,300	6,900	7,130	4,585	5,135	5,735	6,335
--------------	----	----	----	----	-----	---	----	-------	-------	-------	-------	-------	-------	-------	-------	-------

TWO SEAT SOFA

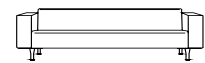

13482	16	24	72	29	27½	6	110	4,500	4,825	7,605	8,435	8,760	5,335	6,155	7,060	7,955
--------------	----	----	----	----	-----	---	-----	-------	-------	-------	-------	-------	-------	-------	-------	-------

THREE SEAT SOFA

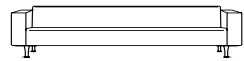

13483	16	24	90	29	27½	7½	140	5,995	6,460	9,810	10,825	11,225	7,025	8,050	9,190	10,305
--------------	----	----	----	----	-----	----	-----	-------	-------	-------	--------	--------	-------	-------	-------	--------

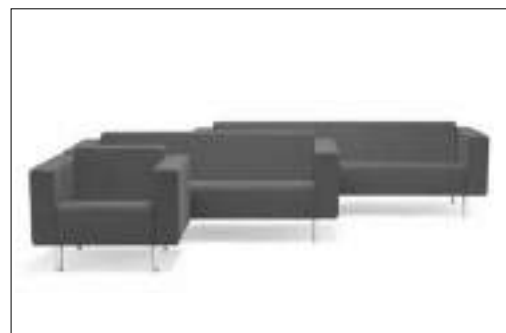









The frame is a laminated wood base frame with tubular steel support under the fixed cushion.

The seat and back are polyurethane foam. The seat foam is covered in Fortrel®. Upholstered in leather or fabric. Tufted seat when upholstered in leather. Back can be tufted if desired.

Laminated wood base frame with tubular steel support under the fixed cushion. The legs are solid aluminum in a brushed finish.

LOUNGE SEATING

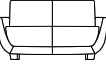
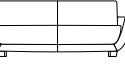
Carlisle Designer - George Yabu & Glenn Pushelburg

														— CDN Only —				
														Knoll Textiles				
Model	Seat	Arm					Fabric	Leather										
Number	H"	H"	W"	D"	H"	Yds.	Sq.Ft.	COM	COL	Neather	Verde	Grano	Cremoso	1	2	3	4	
CHAIR WITH SWIVEL DISK																		
	16200	16 ½	22	33	29	29												
	COM cushions & frame																	
	1 ¼ yds	3 ¼ yds																
	Fully upholstered					4 ½	75	3,440	3,610	3,930	6,240	6,970	7,290	4,055	4,675	5,355	6,025	
	COM seat & back cushions, leather frame					1 ¾	53			3,610	3,620	5,420	5,935	6,140				
CHAIR WITH SWIVEL PEDESTAL BASE																		
	16240	19	24 ½	33	29	32												
	COM cushions & frame																	
	1 ¾ yds	3 ¼ yds																
	Fully upholstered					4 ½	75	3,770	3,950	4,220	6,370	7,090	7,345	4,390	5,010	5,695	6,360	
	COM seat & back cushions, leather frame					1 ¾	53			3,950	3,960	5,455	5,900	6,075				
CHAIR WITH LEGS																		
	16210	16 ½	22	33	29	29												
	COM cushions & frame																	
	1 ¾ yds	3 ¼ yds																
	Fully upholstered					4	70	3,440	3,610	3,880	6,040	6,740	6,995	3,990	4,540	5,140	5,735	
	COM seat & back cushions, leather frame					1 ¾	45			3,610	3,620	5,115	5,560	5,730				
TWO SEAT SOFA																		
	16220	16 ½	22	56 ¾	29	29												
	COM cushions & frame																	
	3 ½ yds	3 ¾ yds																
	Fully upholstered					7	104	5,940	6,240	6,740	9,840	10,865	11,280	6,905	7,865	8,920	9,965	
	COM seat & back cushions, leather frame					3 ½	63			6,240	6,340	8,310	8,935	9,180				
THREE SEAT SOFA																		
	16230	16 ½	22	79 ¾	29	29												
	COM cushions & frame																	
	5 ¼ yds	5 ¼ yds																
	Fully upholstered					10	136	8,780	9,220	9,905	13,890	15,210	15,745	10,155	11,525	13,040	14,525	
	COM seat & back cushions, leather frame					5 ¼	81			9,220	9,375	11,825	12,615	12,940				
OTTOMAN																		
	16250	24 ½			20	16	1 ½	25	2,190	2,305	2,335	3,140	3,375	3,475	2,380	2,565	2,760	2,960
																		

Carlisle series passes CAL 133 certified for an upcharge of \$440 list per chair, \$870 list per two seater sofa, \$1305 list per three seat sofa, and \$380 list per ottoman. Certification applies to Nienkämper leathers and fabrics that have a minimum of 50% natural fibre content. COM's and COL's are subject to approval. Add the extension -CAL to the model number when ordering.

Legs and swivel disk base are upholstered to match the frame.

Swivel pedestal base is in brushed nickel finish.

When upholstered in leather, the two seat sofa (model 16220) has a center seam. When upholstered in fabric, the two seat sofa (model 16220) does not have a center seam.

When upholstering in two different fabrics, use the COM price and ship yardages as noted on page 6.

Model #16200
Fully upholstered



Model #16240
Fully upholstered in Grano leather G7084 Basalt



LOUNGE SEATING

COCOON Designer – Mark Saffell and David Ritch

Model Number	Seat H"	W"	D"	H"	Fabric Yds.	Leather Sq.Ft.	COM	COL	Verde	Grano	Cremoso	— CDN Only —			
												Knoll Textiles			
												1	2	3	4

UPHOLSTERED SEAT

	10901	17	30	30	35½	¾	10	1,150	1,205	1,285	1,325	1,350	1,240	1,325	1,430	1,530
---	--------------	----	----	----	-----	---	----	-------	-------	-------	-------	-------	-------	-------	-------	-------

Cocoon chair passes CAL 133 certified for an upcharge of \$205 list per chair. Certification applies to Nienkämper leathers and fabrics that have a minimum of 50% natural fibre content. COM's and COL's are subject to approval. Add the extension -CAL to the model number when ordering.

Model # 10901
Cocoon Lounge Chair





Standard Features

- Seat cushion upholstered
- Frame: powder coat steel in silver, white, black or red
- Cover: available only in 30 mesh colors

LOUNGE SEATING

Divvi Designer - Christopher Panichella

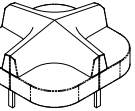
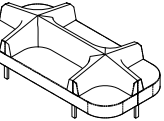
															— CDN Only —			
Model Number	Seat H"	Arm H"	W"	D"	H"	Fabric Yds	Leather Sq. Ft.	COM	COL	Verde	Grano	Cremoso	Knoll Textiles					
													1	2	3	4		
DIVVI 2 SEATER																		
	10241	17	25	52	26	31	5½	102	4,135	4,340	6,520	7,120	7,700	4,910	5,695	6,550	7,385	
							3¾	66										
							2	36										
DIVVI DOUBLE 2 SEATER																		
	10242	17	25	52	52	31	11½	204	8,240	8,660	12,995	14,190	15,375	9,800	11,355	13,065	14,750	
							7¾	132										
							4	72										
DIVVI 4 SEATER																		
	10243	17	25	52	52	31	8	144	10,360	10,870	13,725	14,565	15,405	11,465	12,565	13,770	14,965	
							4	72										
							4	72										
DIVVI 8 SEATER																		
	10244	17	25	106	52	31	15½	276	18,575	19,495	25,015	26,625	28,240	20,680	22,785	25,105	27,385	
							8	144										
							7¾	132										

Model # 10241



Model # 10242



Model # 10243



Model # 10244



Standard features:
Brushed aluminum legs

LOUNGE SEATING

Dobi Designer – Nienkämper

Model Number	Seat H"	W"	D"	H"	Fabric Yds.	Leather Sq. Ft.	COM	COL	Verde	Grano	Cremoso	— CDN Only — Knoll Textiles			
												1	2	3	4

DOBI



11500	16	30	30	31	3	54	2,350	2,465	3,815	4,315	4,510	2,760	3,175	3,625	4,070
--------------	----	----	----	----	---	----	-------	-------	-------	-------	-------	-------	-------	-------	-------

Model # 11500
Dobi Chair



Standard Features

- 360 degree swivel base
- Foam has 20% soy content

LOUNGE SEATING

Dune Metal Designer – busk + hertzog

Model Number	Seat H"	W"	D"	H"	Fabric Yds.	Leather Sq. Ft.	COM	COL	Neather	Verde	Grano	Cremoso	— CDN Only — KnollTextiles			
													1	2	3	4

DUNE CHAIR



10181 15¾ 32 32 28½ 4 54

3,400 3,570 3,675 4,945 5,180 5,420 3,595 3,780 3,980 4,190

DUNE 2 SEATER

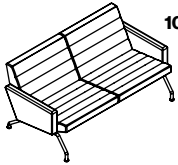

10182 15¾ 58 32 28½ 6.5 117

5,605 5,890 6,195 8,860 9,370 9,890 6,020 6,430 6,865 7,320

DUNE 3 SEATER

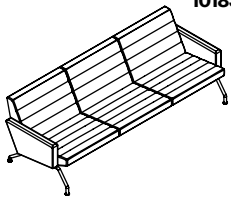

10183 15¾ 85 32 28½ 10 180

7,805 8,200 8,705 12,760 13,555 14,350 8,435 9,065 9,735 10,440

Model # 10181
Dune Chair



Standard Features

- Leg finish: mirror polish chrome, powder coat satin black

LOUNGE SEATING

Dune Wood Designer – busk + hertzog

— CDN Only —
Knoll Textiles

Model Number	Seat H"	W"	D"	H"	Fabric Yds.	Leather Sq. Ft.	COM	COL	Neather	Verde	Grano	Cremoso	1	2	3	4
--------------	---------	----	----	----	-------------	-----------------	-----	-----	---------	-------	-------	---------	---	---	---	---

DUNE CHAIR



10184	15½	32	32	28½	4	54	2,965	3,115	3,240	4,485	4,720	4,960	3,160	3,345	3,545	3,760
--------------	-----	----	----	-----	---	----	-------	-------	-------	-------	-------	-------	-------	-------	-------	-------

DUNE 2 SEATER

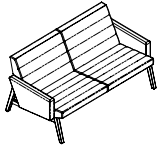

10185	15½	58	32	28½	6.5	117	4,410	4,635	5,005	7,605	8,120	8,640	4,825	5,235	5,670	6,130
--------------	-----	----	----	-----	-----	-----	-------	-------	-------	-------	-------	-------	-------	-------	-------	-------

DUNE 3 SEATER

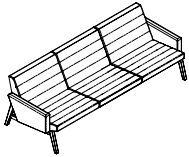

10186	15½	85	32	28½	10	180	5,900	6,195	6,800	10,760	11,550	12,345	6,530	7,155	7,825	8,535
--------------	-----	----	----	-----	----	-----	-------	-------	-------	--------	--------	--------	-------	-------	-------	-------

Model # 10184
Dune Chair



Standard Features

- Leg finish: walnut and white oak.

LOUNGE SEATING

Eden® Designer – Nienkämper

Model Number	Seat H"	Arm H"	*does not include arms			Fabric Yds.	Leather Sq. Ft.	COM	COL	Neather	Verde	Grano	Cremoso	— CDN Only — KnollTextiles			
			W"	D"	H"									1	2	3	4

MEDIUM TWO SEAT WITH CLOSING ELEMENT

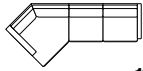

Left closing element

1276_ 17 24 ¼ 116 ¾ 56 ¼ 30 ¾

COM cushions & frame
8 ¼ yds 10 yds

(Model #6) New York Arm, fully upholstered	17 ½	276	16,670	17,500	18,620	25,605	27,965	28,910	19,070	21,475	24,120	26,725
(6) New York Arm, COM cushions, leather frame	8 ¼	113		17,500		20,905	22,010	22,455				
(Model #7) Seattle Arm, fully upholstered	18	273	16,925	17,770	18,950	25,955	28,310	29,265	19,395	21,875	24,585	27,270
(7) Seattle Arm, COM cushions, leather frame	8 ¼	110		17,770		21,225	22,345	22,800				
(Model #8) Boston Arm, fully upholstered	18	279	16,760	17,600	18,780	25,850	28,245	29,215	19,240	21,710	24,430	27,110
(8) Boston Arm, COM cushions, leather frame	8 ¼	116										

LARGE TWO SEAT WITH CLOSING ELEMENT

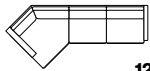

Left closing element

1297_ 17 24 ¼ 123 ¾ 56 ¼ 30 ¾

COM cushions & frame
8 ¼ yds 10 ½ yds

(Model #6) New York Arm, fully upholstered	18	287	17,105	17,955	19,105	26,560	29,060	30,045	19,580	22,050	24,765	27,445
(6) New York Arm, COM cushions, leather frame	8 ¼	122		17,955		21,565	22,715	23,190				
(Model #7) Seattle Arm, fully upholstered	18 ½	285	17,475	18,345	19,540	27,015	29,265	30,550	19,995	22,515	25,280	28,000
(7) Seattle Arm, COM cushions, leather frame	8 ¼	120		18,345		22,010	23,190	23,660				
(Model #8) Boston Arm, fully upholstered	18 ½	290	17,190	18,045	19,245	26,810	29,340	30,360	19,715	22,235	25,005	27,730
(8) Boston Arm, COM cushions, leather frame	8 ¼	125		18,045		21,795	22,990	23,495				

Eden series passes CAL 133 certified for an upcharge of \$490 list per chair, \$975 list per two seater sofa, \$1460 list per three seater sofa, and \$485 list per ottoman. Certification applies to Nienkämper leathers and fabrics that have a minimum of 50% natural fibre content. COM's and COL's are subject to approval. Add the extension -CAL to the model number when ordering.

*Add the width of the arm selected to the width of the sofa, see arm widths below right.

Back cushions have a foam core with Dacron wrap. Choose from two seat cushion fillings. Contract Filling is a firmer cushion. Residential Filling is a softer cushion. Both seat cushions are a combination of foam and down/feathers.

Model #12958 Small two seat with closing element



Model # 6
1 New York Arm
3 ¾ W



Model # 7
1 Seattle Arm
4 ¾ W





Model # 8
1 Boston Arm
5 ½ W





LOUNGE SEATING

Eden® Designer – Nienkämper

Model	Seat		Arm			Fabric Yds.	Leather Sq.Ft.	— CDN Only — KnollTextiles										
	Number	H"	H"	W"	D"			H"	COM	COL	Neather	Verde	Grano	Cremoso	1	2	3	4
SMALL LOUNGE																		
	1277_	17	24¼	23½	33	30¾												
	COM cushions & frame 2¼yds 4yds																	
	(Model #1)	New York Arm, fully upholstered					6	87	4,670	4,895	5,235	7,845	8,685	9,025	5,500	6,325	7,225	8,120
	(1)	New York Arm, COM cushions, leather frame					2¼	57		4,895		6,720	7,290	7,500				
	(Model #2)	Seattle Arm, fully upholstered					6	88	4,910	5,175	5,505	8,225	9,080	9,430	5,745	6,565	7,470	8,365
	(2)	Seattle Arm, COM cushions, leather frame					2¼	58		5,175		7,105	7,655	7,895				
	(Model #3)	Phoenix Arm, fully upholstered					6	90	4,770	5,005	5,340	8,130	9,025	9,375	5,595	6,420	7,320	8,220
	(3)	Phoenix Arm, COM cushions, leather frame					2¼	60		5,005		6,995	7,600	7,840				
	(Model #4)	Dallas Arm, fully upholstered					6	96	4,910	5,175	5,505	8,440	9,365	9,740	5,745	6,565	7,470	8,365
	(4)	Dallas Arm, COM cushions, leather frame					2¼	66		5,175		7,325	7,955	8,220				
	(Model #5)	Miami Arm, fully upholstered					6	88	4,770	5,005	5,340	8,320	9,260	9,635	5,595	6,420	7,320	8,220
	(5)	Miami Arm, COM cushions, leather frame					2¼	58		5,005		7,190	7,840	8,100				



LARGE LOUNGE

	1270_	17	24¼	27½	33	30¾												
	COM cushions & frame 2¾yds 4yds																	
	(Model #1)	New York Arm, fully upholstered					6¼	96	4,670	4,895	5,235	8,035	8,935	9,275	5,535	6,385	7,330	8,260
	(1)	New York Arm, COM cushions, leather frame					2¾	61		4,895		6,915	7,520	7,750				
	(Model #2)	Seattle Arm, fully upholstered					6¼	97	4,910	5,175	5,505	8,415	9,320	9,670	5,775	6,640	7,575	8,505
	(2)	Seattle Arm, COM cushions, leather frame					2¾	62		5,175		7,300	7,895	8,150				
	(Model #3)	Phoenix Arm, fully upholstered					6¼	99	4,770	5,005	5,340	8,320	9,260	9,635	5,625	6,485	7,430	8,360
	(3)	Phoenix Arm, COM cushions, leather frame					2¾	64		5,005		7,190	7,840	8,100				
	(Model #4)	Dallas Arm, fully upholstered					6½	105	4,910	5,175	5,505	8,630	9,605	9,995	5,810	6,700	7,685	8,650
	(4)	Dallas Arm, COM cushions, leather frame					2¾	70		5,175		7,520	8,185	8,460				
	(Model #5)	Miami Arm, fully upholstered					6½	97	4,770	5,005	5,340	8,515	9,500	9,890	5,660	6,555	7,535	8,500
	(5)	Miami Arm, COM cushions, leather frame					2¾	62		5,005		7,380	8,070	8,350				

Eden series passes CAL 133 certified for an upcharge of \$470 list per chair. Certification applies to Nienkämper leathers and fabrics that have a minimum of 50% natural fibre content. COM's and COL's are subject to approval. Add the extension -CAL to the model number when ordering.

*Add the width of the arms selected to the width of the sofa, see arm widths below right.

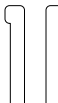
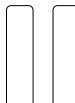
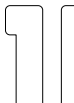
Back cushions have a foam core with Dacron wrap. Choose from two seat cushion fillings. Contract Filling is a firmer cushion. Residential Filling is a softer cushion. Both seat cushions are a combination of foam and down/feathers.

Model # 1 2 New York Arms 6¾ W	Model # 2 2 Seattle Arms 9¾ W	Model # 3 2 Phoenix Arms 12¼ W	Model # 4 2 Dallas Arms 17¼ W	Model # 5 2 Miami Arms 17¼ W
				

LOUNGE SEATING

Eden® Designer – Nienkämper

— CDN Only —

Model Number	Seat H"	Arm H"	* does not include arms			Fabric Yds.	Leather Sq.Ft.	COM	COL	Neather	Verde	Grano	Cremoso	Knoll Textiles			
			W"	D"	H"									1	2	3	4

SMALL TWO SEAT SOFA

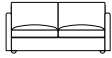

1271_ 17 24 ¼ 55 33 30 ¾

COM cushions & frame
5 ⅓ yds 6 yds

(Model #1) New York Arm, fully upholstered	10 ½	149
(1) New York Arm, COM cushions, leather frame	5 ⅓	80
(Model #2) Seattle Arm, fully upholstered	10 ½	150
(2) Seattle Arm, COM cushions, leather frame	5 ⅓	81
(Model #3) Phoenix Arm, fully upholstered	10 ½	152
(3) Phoenix Arm, COM cushions, leather frame	5 ⅓	83
(Model #4) Dallas Arm, fully upholstered	10 ½	158
(4) Dallas Arm, COM cushions, leather frame	5 ⅓	89
(Model #5) Miami Arm, fully upholstered	10 ½	150
(5) Miami Arm, COM cushions, leather frame	5 ⅓	81

7,110	7,440	8,105	12,440	13,870	14,425	8,560	10,000	11,590	13,150
	7,440		10,285	11,115	11,455				
7,360	7,730	8,355	12,810	14,255	14,835	8,805	10,250	11,835	13,395
	7,730		10,580	11,415	11,755				
7,190	7,555	8,220	12,740	14,185	14,790	8,640	10,080	11,665	13,220
	7,555		10,490	11,360	11,705				
7,360	7,730	8,380	13,050	14,550	15,140	8,805	10,250	11,835	13,395
	7,730		10,805	11,705	12,055				
7,190	7,555	8,285	12,935	14,425	15,050	8,640	10,080	11,665	13,220
	7,555		10,680	11,595	11,970				

MEDIUM TWO SEAT SOFA

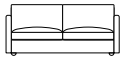

1272_ 17 24 ¼ 60 ½ 33 30 ¾

COM cushions & frame
5 ⅓ yds 6 yds

(Model #1) New York Arm, fully upholstered	10 ½	159
(1) New York Arm, COM cushions, leather frame	5 ⅓	81
(Model #2) Seattle Arm, fully upholstered	10 ½	160
(2) Seattle Arm, COM cushions, leather frame	5 ⅓	82
(Model #3) Phoenix Arm, fully upholstered	10 ½	162
(3) Phoenix Arm, COM cushions, leather frame	5 ⅓	84
(Model #4) Dallas Arm, fully upholstered	10 ½	168
(4) Dallas Arm, COM cushions, leather frame	5 ⅓	90
(Model #5) Miami Arm, fully upholstered	10 ½	160
(5) Miami Arm, COM cushions, leather frame	5 ⅓	82

7,655	8,040	8,735	13,385	14,880	15,490	9,105	10,545	12,130	13,695
	8,040		11,220	12,155	12,530				
7,930	8,320	8,945	13,770	15,295	15,920	9,385	10,830	12,410	13,965
	8,320		11,515	12,470	12,845				
7,770	8,150	8,780	13,695	15,250	15,870	9,215	10,660	12,240	13,805
	8,150		11,440	12,405	12,785				
7,930	8,320	8,960	13,985	15,585	16,220	9,385	10,830	12,410	13,965
	8,320		11,750	12,755	13,155				
7,760	8,135	8,860	13,870	15,465	16,115	9,210	10,655	12,235	13,800
	8,135		11,610	12,625	13,030				

Eden series passes CAL 133 certified for an upcharge of \$975 list per two seater sofa. Certification applies to Nienkämper leathers and fabrics that have a minimum of 50% natural fibre content. COM's and COL's are subject to approval. Add the extension -CAL to the model number when ordering.

*Add the width of the arms selected to the width of the sofa, see arm widths below right.

Back cushions have a foam core with Dacron wrap. Choose from two seat cushion fillings. Contract Filling is a firmer cushion. Residential Filling is a softer cushion. Both seat cushions are a combination of foam and down/feathers.

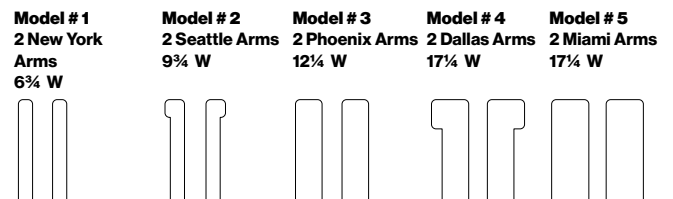

LOUNGE SEATING

Eden® Designer – Nienkämper

— CDN Only —

Model Number	Seat H"	Arm H"	* does not include arms			Fabric Yds.	Leather Sq. Ft.	COM	COL	Neather	Verde	Grano	Cremoso	Knoll Textiles			
			W"	D"	H"									1	2	3	4

LARGE TWO SEAT SOFA

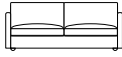

1273_ 17 24 ¼ 67 33 30 ¾

COM cushions & frame
5 ⅓ yds 6 yds

(Model #1) New York Arm, fully upholstered	10 ½	170	8,265	8,685	9,405	14,540	16,165	16,825	9,720	11,160	12,745	14,305
(1) New York Arm, COM cushions, leather frame	5 ⅓	90		8,685		11,535	12,400	12,735				
(Model #2) Seattle Arm, fully upholstered	10 ½	171	8,520	8,955	9,640	14,840	16,505	17,155	9,965	11,410	12,990	14,550
(2) Seattle Arm, COM cushions, leather frame	5 ⅓	91		8,955		11,840	12,735	13,085				
(Model #3) Phoenix Arm, fully upholstered	10 ½	173	8,375	8,790	9,505	14,825	16,515	17,190	9,825	11,270	12,850	14,415
(3) Phoenix Arm, COM cushions, leather frame	5 ⅓	93		8,790		11,830	12,740	13,090				
(Model #4) Dallas Arm, fully upholstered	10 ½	177	8,520	8,955	9,670	15,065	16,790	17,480	9,965	11,410	12,990	14,550
(4) Dallas Arm, COM cushions, leather frame	5 ⅓	97		8,955		11,815	13,010	13,385				
(Model #5) Miami Arm, fully upholstered	10 ½	172	8,375	8,790	9,540	15,005	16,750	17,445	9,825	11,270	12,850	14,415
(5) Miami Arm, COM cushions, leather frame	5 ⅓	92		8,790		12,015	12,970	13,345				

THREE SEAT SOFA

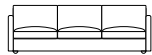

1274_ 17 24 ¼ 82 ½ 33 30 ¾

COM cushions & frame
8 yds 8 yds

(Model #1) New York Arm, fully upholstered	15	203	9,905	10,395	11,375	16,830	18,655	19,380	11,965	14,030	16,295	18,520
(1) New York Arm, COM cushions, leather frame	8	100		10,395		13,465	14,400	14,785				
(Model #2) Seattle Arm, fully upholstered	15	203	10,170	10,680	11,625	17,195	19,050	19,790	12,230	14,295	16,560	18,790
(2) Seattle Arm, COM cushions, leather frame	8	100		10,680		13,820	14,795	15,185				
(Model #3) Phoenix Arm, fully upholstered	15	206	10,000	10,515	11,470	17,115	18,990	19,735	12,060	14,125	16,390	18,620
(3) Phoenix Arm, COM cushions, leather frame	8	103		10,515		13,745	14,745	15,105				
(Model #4) Dallas Arm, fully upholstered	15	209	10,170	10,680	11,640	17,420	19,345	20,110	12,230	14,295	16,560	18,790
(4) Dallas Arm, COM cushions, leather frame	8	108		10,680		14,055	15,070	15,490				
(Model #5) Miami Arm, fully upholstered	15	204	10,000	10,515	11,495	17,305	19,230	19,995	12,060	14,125	16,390	18,620
(5) Miami Arm, COM cushions, leather frame	8	101		10,515		13,940	14,980	15,380				

Eden series passes CAL 133 certified for an upcharge of \$1460 list per three seat sofa. Certification applies to Nienkämper leathers and fabrics that have a minimum of 50% natural fibre content. COM's and COL's are subject to approval. Add the extension -CAL to the model number when ordering.

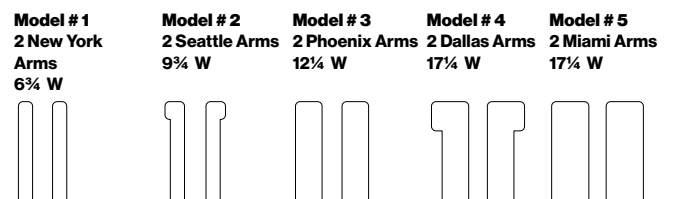

*Add the width of the arms selected to the width of the sofa, see arm widths below right.

Back cushions have a foam core with Dacron wrap. Choose from two seat cushion fillings. Contract Filling is a firmer cushion. Residential Filling is a softer cushion. Both seat cushions are a combination of foam and down/feathers.

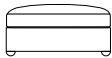

LOUNGE SEATING

Eden® Designer – Nienkämper

Model Number	W"	D"	H"	Fabric Yds.	Leather Sq. Ft.	COM	COL	Neather	Verde	Grano	Cremoso	— CDN Only — KnollTextiles			
												1	2	3	4
SMALL OTTOMAN															
 1275	27½	19¾	17	2½	45	1,870	1,980	2,140	3,380	3,775	3,930	2,225	2,565	2,940	3,310
LARGE OTTOMAN															
 1276	34¾	34¾	17	3½	54	2,310	2,430	2,640	4,105	4,585	4,785	2,795	3,280	3,810	4,330
SMALL THROW CUSHION															
 127S	16	16		½	8	285	295	330	570	640	685	360	430	500	575
LARGE THROW CUSHION															
 127L	20	20		¾	10	285	295	355	640	745	790	395	495	610	715

Eden series passes CAL 133 certified for an upcharge of \$485 list per ottoman. Certification applies to Nienkämper leathers and fabrics that have a minimum of 50% natural fibre content. COM's and COL's are subject to approval. Add the extension -CAL to the model number when ordering.

Seat cushions are a combination of foam and down/feathers.

LOUNGE SEATING

Eden® Designer – Nienkämper

Model Number	Seat H"	Arm H"	* does not include arms			Fabric Yds.	Leather Sq. Ft.	COM	COL	Neather	Verde	Grano	Cremoso	— CDN Only — Knoll Textiles			
			W"	D"	H"									1	2	3	4

SMALL TWO SEAT SOFA, DEEP

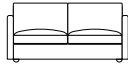

1280_ 17 24 ¼ 55 38 ½ 30 ¾

COM cushions & frame
5 ⅔ yds 6 ½ yds



(Model #1) New York Arm, fully upholstered	12	152	8,200	8,595	9,320	14,110	15,670	16,295	9,845	11,495	13,305	15,090
(1) New York Arm, COM cushions, leather frame	5 ⅔	82		8,595		11,110	11,880	12,200				
(Model #2) Seattle Arm, fully upholstered	12	156	8,440	8,865	9,555	14,425	16,010	16,630	10,095	11,735	13,545	15,340
(2) Seattle Arm, COM cushions, leather frame	5 ⅔	86		8,865		11,440	12,220	12,540				
(Model #3) Phoenix Arm, fully upholstered	12	157	8,285	8,705	9,415	14,380	15,990	16,640	9,940	11,590	13,395	15,185
(3) Phoenix Arm, COM cushions, leather frame	5 ⅔	87		8,705		11,400	12,210	12,550				
(Model #4) Dallas Arm, fully upholstered	12	163	8,440	8,865	9,595	14,645	16,295	16,940	10,095	11,735	13,545	15,340
(4) Dallas Arm, COM cushions, leather frame	5 ⅔	93		8,865		11,640	12,515	12,845				
(Model #5) Miami Arm, fully upholstered	12	162	8,285	8,705	9,440	14,575	16,230	16,905	9,940	11,590	13,395	15,185
(5) Miami Arm, COM cushions, leather frame	5 ⅔	92		8,705		11,590	12,440	12,790				

LARGE TWO SEAT SOFA, DEEP

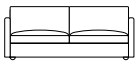

1281_ 17 24 ¼ 67 38 ½ 30 ¾

COM cushions & frame
5 ⅔ yds 6 ½ yds

(Model #1) New York Arm, fully upholstered	12	173	9,475	9,950	10,935	16,400	18,230	18,955	11,120	12,770	14,585	16,370
(1) New York Arm, COM cushions, leather frame	15 ⅔	90		9,950		13,030	13,960	14,350				
(Model #2) Seattle Arm, fully upholstered	12	177	9,730	10,215	11,185	16,760	18,615	19,360	11,385	13,030	14,840	16,625
(2) Seattle Arm, COM cushions, leather frame	15 ⅔	94		10,215		13,395	14,360	14,750				
(Model #3) Phoenix Arm, fully upholstered	12	178	9,590	10,070	11,040	16,690	18,575	19,330	11,245	12,890	14,700	16,495
(3) Phoenix Arm, COM cushions, leather frame	15 ⅔	95		10,070		13,325	14,320	14,695				
(Model #4) Dallas Arm, fully upholstered	12	184	9,730	10,215	11,220	17,000	18,910	19,665	11,385	13,030	14,840	16,625
(4) Dallas Arm, COM cushions, leather frame	5 ⅔	101		10,215		13,620	14,640	15,060				
(Model #5) Miami Arm, fully upholstered	12	183	9,590	10,070	11,075	16,880	18,810	19,570	11,245	12,890	14,700	16,495
(5) Miami Arm, COM cushions, leather frame	5 ⅔	100		10,070		13,515	14,550	14,975				

Eden series passes CAL 133 certified for an upcharge of \$975 list per two seater sofa. Certification applies to Nienkämper leathers and fabrics that have a minimum of 50% natural fibre content. COM's and COL's are subject to approval. Add the extension -CAL to the model number when ordering.

*Add the width of the arms selected to the width of the sofa, see arm widths below right.

Back cushions have a foam core with Dacron wrap. Choose from two seat cushion fillings. Contract Filling is a firmer cushion. Residential Filling is a softer cushion. Both seat cushions are a combination of foam and down/feathers.

Model #12813
Large two seat, deep



Model # 1 2 New York Arms 6¾ W	Model # 2 2 Seattle Arms 9¾ W	Model # 3 2 Phoenix Arms 12¼ W	Model # 4 2 Dallas Arms 17¼ W	Model # 5 2 Miami Arms 17¼ W

LOUNGE SEATING

Eden® Designer – Nienkämper

Model Number	Seat H"	Arm H"	* does not include arms			Fabric Yds.	Leather Sq.Ft.	COM	COL	Neather	Verde	Grano	Cremoso	— CDN Only — Knoll Textiles			
			W"	D"	H"									1	2	3	4

THREE SEAT SOFA, DEEP

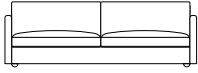

1282_ 17 24¼ 82½ 38½ 30¾

COM cushions & frame
5 ⅔ yds 6½ yds

(Model #1) New York Arm, fully upholstered	12	205	10,880	11,415	12,435	18,435	20,420	21,220	12,535	14,175	15,990	17,780
(1) New York Arm, COM cushions, leather frame	5½	100		11,415		14,680	15,700	16,110				
(Model #2) Seattle Arm, fully upholstered	12	210	11,130	11,690	12,745	18,775	20,775	21,595	12,785	14,435	16,245	18,035
(2) Seattle Arm, COM cushions, leather frame	5¾	105		11,690		15,035	16,050	16,465				
(Model #3) Phoenix Arm, fully upholstered	12	211	10,990	11,535	12,590	18,730	20,770	21,580	12,640	14,290	16,100	17,890
(3) Phoenix Arm, COM cushions, leather frame	5¾	106		11,535		14,990	16,045	16,455				
(Model #4) Dallas Arm, fully upholstered	12	216	11,130	11,690	12,745	18,995	21,075	21,885	12,785	14,435	16,245	18,035
(4) Dallas Arm, COM cushions, leather frame	5¾	110		11,690		15,260	16,340	16,780				
(Model #5) Miami Arm, fully upholstered	12	215	10,990	11,535	12,590	18,925	21,000	21,830	12,640	14,290	16,100	17,890
(5) Miami Arm, COM cushions, leather frame	5¾	110		11,535		15,185	16,290	16,720				

Eden series passes CAL 133 certified for an upcharge of \$1460 list per three seat sofa. Certification applies to Nienkämper leathers and fabrics that have a minimum of 50% natural fibre content. COM's and COL's are subject to approval. Add the extension -CAL to the model number when ordering.

*Add the width of the arms selected to the width of the sofa, see arm widths below right.

Back cushions have a foam core with Dacron wrap. Choose from two seat cushion fillings. Contract Filling is a firmer cushion. Residential Filling is a softer cushion. Both seat cushions are a combination of foam and down/feathers.

Model # 1 2 New York Arms 6¾ W	Model # 2 2 Seattle Arms 9¾ W	Model # 3 2 Phoenix Arms 12¾ W	Model # 4 2 Dallas Arms 17¼ W	Model # 5 2 Miami Arms 17¼ W

LOUNGE SEATING

Eden® Designer – Nienkämper

Model Number	Seat H"	Arm H"	* does not include arms			Fabric Yds.	Leather Sq. Ft.	COM	COL	Neather	Verde	Grano	Cremoso	— CDN Only — Knoll Textiles			
			W"	D"	H"									1	2	3	4

FOUR SEAT 90° CORNER

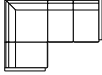

1283_ 17 24 ¼ 88 60 ½ 30 ¾

COM cushions & frame
12 ⅔ yds 9 yds

(Model #1) New York Arm, fully upholstered	20 ⅔	289	15,830	16,630	17,865	25,230	27,700	28,695	18,670	21,510	24,635	27,705
(1) New York Arm, COM cushions, leather frame	12 ⅔	136		16,630		20,370	21,570	22,030				
(Model #2) Seattle Arm, fully upholstered	20 ⅔	289	16,115	16,915	18,150	25,605	28,110	29,105	18,950	21,790	24,910	27,980
(2) Seattle Arm, COM cushions, leather frame	12 ⅔	136		16,915		20,755	21,980	22,455				
(Model #3) Phoenix Arm, fully upholstered	20 ⅔	291	15,930	16,730	17,970	25,505	28,035	29,050	18,770	21,605	24,730	27,800
(3) Phoenix Arm, COM cushions, leather frame	12 ⅔	138		16,730		20,655	21,885	22,385				
(Model #4) Dallas Arm, fully upholstered	21 ¼	298	16,115	16,915	18,210	25,840	28,405	29,430	19,035	21,955	25,160	28,320
(4) Dallas Arm, COM cushions, leather frame	12 ⅔	145		16,915		20,965	22,245	22,755				
(Model #5) Miami Arm, fully upholstered	21 ¼	284	15,930	16,730	18,030	25,705	28,265	29,295	18,850	21,770	24,975	28,140
(5) Miami Arm, COM cushions, leather frame	12 ⅔	131		16,730		20,840	22,120	22,655				

FIVE SEAT 90° CORNER

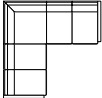

1284_ 17 24 ¼ 88 88 30 ¾

COM cushions & frame
15 ⅓ yds 10 ⅓ yds

(Model #1) New York Arm, fully upholstered	24 ⅔	342	18,320	19,240	20,210	29,390	32,305	33,465	21,705	25,095	28,825	32,490
(1) New York Arm, COM cushions, leather frame	15 ⅓	154		19,240		23,520	24,885	25,445				
(Model #2) Seattle Arm, fully upholstered	24 ⅔	342	18,580	19,510	21,000	29,760	32,705	33,895	21,975	25,355	29,080	32,755
(2) Seattle Arm, COM cushions, leather frame	15 ⅓	154		19,510		23,890	25,290	25,845				
(Model #3) Phoenix Arm, fully upholstered	24 ⅔	344	18,435	19,360	20,855	29,695	32,665	33,840	21,820	25,215	28,935	32,605
(3) Phoenix Arm, COM cushions, leather frame	15 ⅓	156		19,360		23,815	25,230	25,810				
(Model #4) Dallas Arm, fully upholstered	25 ¼	351	18,580	19,510	20,530	29,985	33,000	34,200	22,050	25,525	29,330	33,095
(4) Dallas Arm, COM cushions, leather frame	15 ⅓	163		19,510		24,115	25,570	26,170				
(Model #5) Miami Arm, fully upholstered	25 ¼	343	18,435	19,360	20,925	29,890	32,895	34,095	21,905	25,380	29,185	32,945
(5) Miami Arm, COM cushions, leather frame	15 ¼	155		19,360		24,000	25,465	26,060				

Eden series passes CAL 133 certified for an upcharge of \$2140 list per four seat sofa. Certification applies to Nienkämper leathers and fabrics that have a minimum of 50% natural fibre content. COM's and COL's are subject to approval. Add the extension -CAL to the model number when ordering.

*Add the width of the arms selected to the width of the sofa, see arm widths below right.

Back cushions have a foam core with Dacron wrap. Choose from two seat cushion fillings. Contract Filling is a firmer cushion. Residential Filling is a softer cushion. Both seat cushions are a combination of foam and down/feathers.

Model # 1 2 New York Arms 6 ¾ W	Model # 2 2 Seattle Arms 9 ¾ W	Model # 3 2 Phoenix Arms 12 ¼ W	Model # 4 2 Dallas Arms 17 ¼ W	Model # 5 2 Miami Arms 17 ¼ W

LOUNGE SEATING

Eden® Designer – Nienkämper

Model Number	Seat Arm		* does not include arms			Fabric Yds.	Leather Sq. Ft.	COM	COL	Neather	Verde	Grano	Cremoso	— CDN Only — Knoll Textiles			
	H"	H"	W"	D"	H"									1	2	3	4

SIX SEAT 90° CORNER

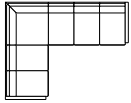

1285_ 17 24 ¼ 115 ½ 88 30 ¾

COM cushions & frame
18yds 11 ½yds

(Model #1) New York Arm, fully upholstered	28%	407	21,090	22,125	23,920	33,845	37,210	38,545	25,030	28,970	33,295	37,560
(1) New York Arm, COM cushions, leather frame	18	174		22,125		26,970	28,510	29,110				
(Model #2) Seattle Arm, fully upholstered	28%	407	21,345	22,425	24,165	34,215	37,610	38,970	25,285	29,230	33,555	37,815
(2) Seattle Arm, COM cushions, leather frame	18	174		22,425		27,335	29,050	29,540				
(Model #3) Phoenix Arm, fully upholstered	28%	409	21,190	22,245	24,015	34,155	37,555	38,920	25,130	29,070	33,400	37,660
(3) Phoenix Arm, COM cushions, leather frame	18	176		22,245		27,255	28,855	29,485				
(Model #4) Dallas Arm, fully upholstered	29 ¼	416	21,345	22,425	24,220	34,435	37,890	39,265	25,360	29,385	33,800	38,160
(4) Dallas Arm, COM cushions, leather frame	18	183		22,425		27,555	29,190	29,835				
(Model #5) Miami Arm, fully upholstered	29 ¼	408	21,190	22,245	24,075	34,335	37,795	39,175	25,215	29,235	33,650	38,000
(5) Miami Arm, COM cushions, leather frame	18	175		22,245		27,435	29,095	29,745				

SEVEN SEAT 90° CORNER

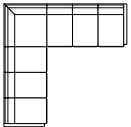

1286_ 17 24 ¼ 115 ½ 115 ½ 30 ¾

COM cushions & frame
20 ¾yds 13yds

(Model #1) New York Arm, fully upholstered	32%	450	23,815	25,010	27,035	38,270	42,070	43,595	28,310	32,800	37,735	42,590
(1) New York Arm, COM cushions, leather frame	20%	192		25,010		30,370	32,085	32,785				
(Model #2) Seattle Arm, fully upholstered	32%	450	24,075	25,280	27,290	38,625	42,465	44,005	28,555	33,045	37,980	42,840
(2) Seattle Arm, COM cushions, leather frame	20%	192		25,280		30,725	32,480	33,200				
(Model #3) Phoenix Arm, fully upholstered	32%	452	23,920	25,105	27,150	38,550	42,420	43,950	28,415	32,900	37,835	42,695
(3) Phoenix Arm, COM cushions, leather frame	20%	194		25,105		30,660	32,435	33,140				
(Model #4) Dallas Arm, fully upholstered	33 ¼	459	24,075	25,280	27,360	38,845	42,730	44,300	28,640	33,215	38,230	43,180
(4) Dallas Arm, COM cushions, leather frame	20%	201		25,280		30,905	32,780	33,490				
(Model #5) Miami Arm, fully upholstered	33 ¼	452	23,920	25,105	27,195	38,740	42,650	44,200	28,495	33,060	38,085	43,030
(5) Miami Arm, COM cushions, leather frame	20%	194		25,105		30,850	32,675	33,405				

Eden series passes CAL 133 certified for an upcharge of \$2915 list for six seat and \$3400 list for seven seat. Certification applies to Nienkämper leathers and fabrics that have a minimum of 50% natural fibre content. COM's and COL's are subject to approval. Add the extension -CAL to the model number when ordering.

*Add the width of the arms selected to the width of the sofa, see arm widths below right.

Back cushions have a foam core with Dacron wrap. Choose from two seat cushion fillings. Contract Filling is a firmer cushion. Residential Filling is a softer cushion. Both seat cushions are a combination of foam and down/feathers.

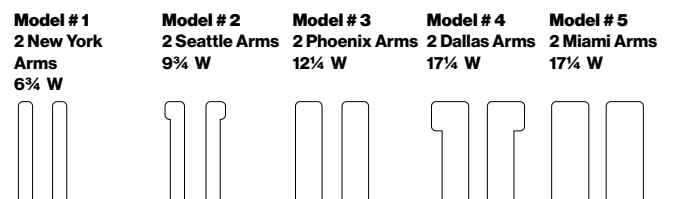

LOUNGE SEATING

Eden® Designer – Nienkämper

— CDN Only —

Model Number	Seat Arm		*does not include arms			Fabric Yds.	Leather Sq. Ft.	COM	COL	Neather	Verde	Grano	Cremoso	Knoll Textiles			
	H"	H"	W"	D"	H"									1	2	3	4

FIVE SEAT QUADRILATERAL CORNER

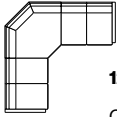

1287_ 17 24 ¼ 102 130 30 ¾

COM cushions & frame
15yds 13yds

(Model #1) New York Arm, fully upholstered	27 ¼	372	21,105	22,165	23,785	33,570	36,850	38,160	24,855	28,600	32,710	36,770
(1) New York Arm, COM cushions, leather frame	15	163		22,165		26,865	28,395	29,015				
(Model #2) Seattle Arm, fully upholstered	27 ⅔	372	21,375	22,440	24,105	33,960	37,255	38,560	25,185	28,980	33,160	37,275
(2) Seattle Arm, COM cushions, leather frame	15	163		22,440		27,235	28,810	29,415				
(Model #3) Phoenix Arm, fully upholstered	27 ⅔	375	21,220	22,275	23,950	33,865	37,190	38,525	25,020	28,820	33,000	37,115
(3) Phoenix Arm, COM cushions, leather frame	15	166		22,275		27,170	28,730	29,355				
(Model #4) Dallas Arm, fully upholstered	27 ⅔	386	21,375	22,440	24,105	34,175	37,550	38,885	25,185	28,980	33,160	37,275
(4) Dallas Arm, COM cushions, leather frame	15	173		22,440		27,475	29,070	29,730				
(Model #5) Miami Arm, fully upholstered	27 ⅔	365	21,220	22,275	23,950	34,050	37,420	38,790	25,020	28,820	33,000	37,115
(5) Miami Arm, COM cushions, leather frame	15	164		22,275		27,355	28,960	29,620				

Eden series passes CAL 133 certified for an upcharge of \$2915 list for six seat, \$3400 list for seven seat, and \$3890 list for eight seat. Certification applies to Nienkämper leathers and fabrics that have a minimum of 50% natural fibre content. COM's and COL's are subject to approval. Add the extension -CAL to the model number when ordering.

*Add the width of the arms selected to the width of the sofa, see arm widths below right.

Back cushions have a foam core with Dacron wrap. Choose from two seat cushion fillings. Contract Filling is a firmer cushion. Residential Filling is a softer cushion. Both seat cushions are a combination of foam and down/feathers.

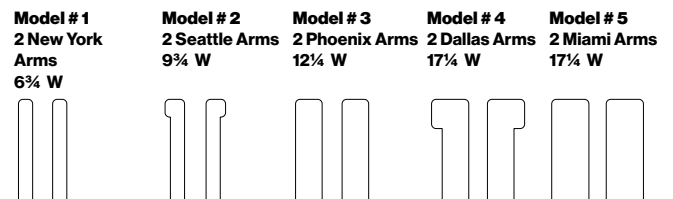

LOUNGE SEATING

Eden® Designer – Nienkämper

— CDN Only —

Model Number	Seat Arm		* does not include arms			Fabric Yds.	Leather Sq. Ft.	COM	COL	Neather	Verde	Grano	Cremoso	Knoll Textiles			
	H"	H"	W"	D"	H"									1	2	3	4

SIX SEAT QUADRILATERAL CORNER

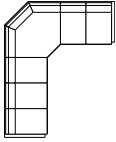

1288_ 17 24¼ 102½ 130 30¾

COM cushions & frame
17½ yds 14 ½ yds

(Model #1) New York Arm, fully upholstered	31¼	427	23,865	25,065	26,950	38,010	41,725	43,220	28,160	32,455	37,170	41,820
(1) New York Arm, COM cushions, leather frame	17½	183		25,065		30,300	32,005	32,680				
(Model #2) Seattle Arm, fully upholstered	31¾	427	24,115	25,305	27,225	38,355	42,115	43,620	28,475	32,820	37,600	42,305
(2) Seattle Arm, COM cushions, leather frame	17½	183		25,305		30,660	32,395	33,060				
(Model #3) Phoenix Arm, fully upholstered	31¾	429	23,955	25,135	27,060	38,295	42,060	43,575	28,305	32,655	37,435	42,145
(3) Phoenix Arm, COM cushions, leather frame	17½	185		25,135		30,580	32,320	33,010				
(Model #4) Dallas Arm, fully upholstered	31¾	435	24,115	25,305	27,225	38,590	42,420	43,935	28,475	32,820	37,600	42,305
(4) Dallas Arm, COM cushions, leather frame	17½	192		25,305		30,885	32,675	33,385				
(Model #5) Miami Arm, fully upholstered	31¾	428	23,955	25,135	27,060	38,480	42,295	43,825	28,305	32,655	37,435	42,145
(5) Miami Arm, COM cushions, leather frame	17½	184		25,135		30,775	32,575	33,265				

Eden series passes CAL 133 certified for an upcharge of \$2915 list for six seat. Certification applies to Nienkämper leathers and fabrics that have a minimum of 50% natural fibre content. COM's and COL's are subject to approval. Add the extension -CAL to the model number when ordering.

*Add the width of the arms selected to the width of the sofa, see arm widths below right.

Back cushions have a foam core with Dacron wrap. Choose from two seat cushion fillings. Contract Filling is a firmer cushion. Residential Filling is a softer cushion. Both seat cushions are a combination of foam and down/feathers.

Model # 1 2 New York Arms 6¾ W	Model # 2 2 Seattle Arms 9¾ W	Model # 3 2 Phoenix Arms 12¼ W	Model # 4 2 Dallas Arms 17¼ W	Model # 5 2 Miami Arms 17¼ W

LOUNGE SEATING

Eden® Designer – Nienkämper

— CDN Only —

Model Number	Seat Arm		* does not include arms			Fabric Yds.	Leather Sq.Ft.	COM	COL	Neather	Verde	Grano	Cremoso	Knoll Textiles			
	H"	H"	W"	D"	H"									1	2	3	4

SEVEN SEAT QUADRILATERAL CORNER

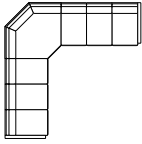

1289_ 17 24 ¼ 130 130 30 ¾

COM cushions & frame
20 ¼ yds 15 ⅝ yds

(Model #1) New York Arm, fully upholstered	35 ¼	481	26,600	27,940	30,070	42,435	46,590	48,255	31,450	36,290	41,610	46,855
(1) New York Arm, COM cushions, leather frame	20 ¼	201		27,940		33,705	35,570	36,315				
(Model #2) Seattle Arm, fully upholstered	35 ⅝	480	26,860	28,200	30,380	42,800	47,000	48,675	31,765	36,665	42,055	47,355
(2) Seattle Arm, COM cushions, leather frame	20 ¼	201		28,200		34,070	35,990	36,750				
(Model #3) Phoenix Arm, fully upholstered	35 ⅝	483	26,705	28,035	30,210	42,715	46,935	48,635	31,595	36,495	41,885	47,190
(3) Phoenix Arm, COM cushions, leather frame	20 ¼	204		28,035		34,000	35,910	36,695				
(Model #4) Dallas Arm, fully upholstered	35 ⅝	489	26,860	28,200	30,380	43,020	47,285	48,990	31,765	36,665	42,055	47,355
(4) Dallas Arm, COM cushions, leather frame	20 ¼	210		28,200		34,305	36,275	37,020				
(Model #5) Miami Arm, fully upholstered	35 ⅝	481	26,705	28,035	30,210	42,910	47,175	48,885	31,595	36,495	41,885	47,190
(5) Miami Arm, COM cushions, leather frame	20 ¼	202		28,035		34,190	36,145	36,945				

Eden series passes CAL 133 certified for an upcharge of \$3400 list for seven seat. Certification applies to Nienkämper leathers and fabrics that have a minimum of 50% natural fibre content. COM's and COL's are subject to approval. Add the extension -CAL to the model number when ordering.

*Add the width of the arms selected to the width of the sofa, see arm widths below right.

Back cushions have a foam core with Dacron wrap. Choose from two seat cushion fillings. Contract Filling is a firmer cushion. Residential Filling is a softer cushion. Both seat cushions are a combination of foam and down/feathers.

Model # 1 2 New York Arms 6 ¾ W	Model # 2 2 Seattle Arms 9 ¼ W	Model # 3 2 Phoenix Arms 12 ¼ W	Model # 4 2 Dallas Arms 17 ¼ W	Model # 5 2 Miami Arms 17 ¼ W

LOUNGE SEATING

Eden® with Legs Designer – Nienkämper

Model Number	Seat H"	Arm H"	Arm W"	D"	H"	Fabric Yds.	Leather Sq. Ft.	— CDN Only — Knoll Textiles							
								COM	COL	Neather	Verde	Grano	Cremoso	1	2

*does not include arms

SMALL LOUNGE



1278_ 17 24¼ 23½ 33 30¾

COM cushions & frame
2¼ yds 4 yds



	Fabric Yds.	Leather Sq. Ft.	COM	COL	Neather	Verde	Grano	Cremoso	1	2	3	4
(Model #6) New York Arm, fully upholstered	5⅓	82	4,890	5,115	5,485	7,575	8,285	8,565	5,620	6,355	7,160	7,955
(6) New York Arm, COM cushions, leather frame	2¼	52		5,115		6,475	6,875	7,025				
(Model #7) Seattle Arm, fully upholstered	5%	80	5,130	5,385	5,760	7,895	8,630	8,935	5,910	6,685	7,540	8,380
(7) Seattle Arm, COM cushions, leather frame	2¼	50		5,385		6,765	7,205	7,380				
(Model #8) Boston Arm, fully upholstered	5%	85	4,990	5,235		7,830	8,570	8,880	5,765	6,545	7,405	8,240
(8) Boston Arm, COM cushions, leather frame	2¼	55		5,235		6,485	6,890	7,025				

LARGE LOUNGE



1290_ 17 24¼ 27½ 33 30¾

COM cushions & frame
2⅔ yds 4 yds

	Fabric Yds.	Leather Sq. Ft.	COM	COL	Neather	Verde	Grano	Cremoso	1	2	3	4
(Model #6) New York Arm, fully upholstered	6	92	4,890	5,115	5,515	7,770	8,520	8,820	5,720	6,545	7,445	8,345
(6) New York Arm, COM cushions, leather frame	2⅔	57		5,115		6,665	7,110	7,305				
(Model #7) Seattle Arm, fully upholstered	6¼	90	5,130	5,385	5,825	8,075	8,865	9,180	5,995	6,855	7,795	8,730
(7) Seattle Arm, COM cushions, leather frame	2⅔	55		5,385		6,950	7,440	7,640				
(Model #8) Boston Arm, fully upholstered	6¼	95	4,990	5,235	5,685	8,025	8,810	9,135	5,845	6,705	7,650	8,580
(8) Boston Arm, COM cushions, leather frame	2⅔	60		5,235		6,905	7,400	7,595				

SMALL TWO SEAT SOFA



1291_ 17 24¼ 55 33 30¾

COM cushions & frame
5⅓ yds 6 yds

	Fabric Yds.	Leather Sq. Ft.	COM	COL	Neather	Verde	Grano	Cremoso	1	2	3	4
(Model #6) New York Arm, fully upholstered	10½	146	7,405	7,770	8,340	11,895	13,085	13,545	8,850	10,290	11,875	13,430
(6) New York Arm, COM cushions, leather frame	5⅓	76		7,770		10,095	10,825	11,085				
(Model #7) Seattle Arm, fully upholstered	10½	140	7,655	8,040	8,640	12,220	13,415	13,920	9,105	10,545	12,130	13,695
(7) Seattle Arm, COM cushions, leather frame	5⅓	74		8,040		10,430	11,165	11,455				
(Model #8) Boston Arm, fully upholstered	10½	149	7,520	7,860	8,475	12,150	13,365	13,870	8,970	10,410	11,995	13,555
(8) Boston Arm, COM cushions, leather frame	5⅓	79		7,860		10,360	11,105	11,400				

Eden series passes CAL 133 certified for an upcharge of \$490 list per chair and \$975 list per two seater sofa. Certification applies to Nienkämper leathers and fabrics that have a minimum of 50% natural fibre content. COM's and COL's are subject to approval. Add the extension -CAL to the model number when ordering.

*Add the width of the arms selected to the width of the sofa, see arm widths below right.

Back cushions have a foam core with Dacron wrap. Choose from two seat cushion fillings. Contract Filling is a firmer cushion. Residential Filling is a softer cushion. Both seat cushions are a combination of foam and down/feathers.

Model #12908
Large Lounge



Model # 6
2 New York Arms
6% W

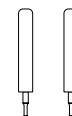

Model # 7
2 Seattle Arms
9% W

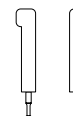

Model # 8
2 Boston Arms
10% W

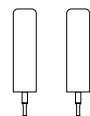

LOUNGE SEATING

Eden® with Legs Designer – Nienkämper

Model Number	Seat Arm		*does not include arms			Fabric Yds.	Leather Sq. Ft.	COM	COL	Neather	Verde	Grano	Cremoso	— CDN Only — Knoll Textiles			
	H"	H"	W"	D"	H"									1	2	3	4

MEDIUM TWO SEAT SOFA

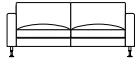

1292_ 17 24¼ 60½ 33 30¾

COM cushions & frame
5 ⅓ yds 6 yds

(Model #6) New York Arm, fully upholstered	10½	151	7,980	8,375	8,985	13,030	14,360	14,880	9,425	10,870	12,450	14,020
(6) New York Arm, COM cushions, leather frame	5⅓	78		8,375		10,895		11,650		11,980		
(Model #7) Seattle Arm, fully upholstered	10½	153	8,240	8,665	9,280	13,370	14,740	15,260	9,690	11,125	12,720	14,275
(7) Seattle Arm, COM cushions, leather frame	5⅓	75		8,665		11,230		12,030		12,340		
(Model #8) Boston Arm, fully upholstered	10½	158	8,100	8,505	9,145	13,310	14,655	15,210	9,545	10,990	12,570	14,135
(8) Boston Arm, COM cushions, leather frame	5⅓	80		8,505		11,170		11,970		12,300		

LARGE TWO SEAT SOFA



1293_ 17 24¼ 67 33 30¾

COM cushions & frame
5 ⅓ yds 6 yds

(Model #6) New York Arm, fully upholstered	10½	166	8,610	9,030	9,645	14,170	15,655	16,235	10,060	11,500	13,085	14,645
(6) New York Arm, COM cushions, leather frame	5⅓	86		9,030		11,705		12,530		12,865		
(Model #7) Seattle Arm, fully upholstered	10½	164	8,865	9,310	9,950	14,535	16,010	16,600	10,315	11,755	13,335	14,900
(7) Seattle Arm, COM cushions, leather frame	5⅓	84		9,310		12,040		12,885		13,210		
(Model #8) Boston Arm, fully upholstered	10½	169	8,705	9,145	9,790	14,425	15,930	16,535	10,160	11,605	13,185	14,745
(8) Boston Arm, COM cushions, leather frame	5⅓	89		9,145		11,970		12,810		13,160		

Eden series passes CAL 133 certified for an upcharge of \$975 list per two seater sofa. Certification applies to Nienkämper leathers and fabrics that have a minimum of 50% natural fibre content. COM's and COL's are subject to approval. Add the extension -CAL to the model number when ordering.

*Add the width of the arms selected to the width of the sofa, see arm widths below right.

Back cushions have a foam core with Dacron wrap. Choose from two seat cushion fillings. Contract Filling is a firmer cushion. Residential Filling is a softer cushion. Both seat cushions are a combination of foam and down/feathers.

Model #12938 Large two seat sofa



Model # 6
2 New York Arms
6¾ W

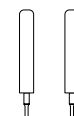

Model # 7
2 Seattle Arms
9¾ W

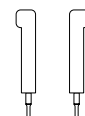

Model # 8
2 Boston Arms
10¾ W

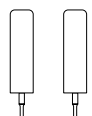

LOUNGE SEATING

Eden® with Legs Designer – Nienkämper

Model Number	Seat Arm		* does not include arms			Fabric Yds.	Leather Sq.Ft.	COM	COL	Neather	Verde	Grano	Cremoso	— CDN Only — Knoll Textiles			
	H"	H"	W"	D"	H"									1	2	3	4

THREE SEAT SOFA



1279_ 17 24¼ 82¼ 33 30¾

COM cushions & frame
8 yds 7 ½ yds

(Model #6) New York Arm, fully upholstered	14½	198	10,240	10,755	11,700	17,155	18,990	19,725	12,230	14,225	16,415	18,575
(6) New York Arm, COM cushions, leather frame	8	95	10,755	13,785	14,745	15,095						
(Model #7) Seattle Arm, fully upholstered	14½	195	10,495	11,020	11,170	14,160	15,105	15,500	12,485	14,480	16,675	18,830
(7) Seattle Arm, COM cushions, leather frame	8	92	11,020	21,225	22,345	22,800						
(Model #8) Boston Arm, fully upholstered	14½	201	10,350	10,865	11,795	17,450	19,335	20,085	12,345	14,335	16,530	18,685
(8) Boston Arm, COM cushions, leather frame	8	98	10,865	14,095	15,065	15,465						

Eden series passes CAL 133 certified for an upcharge of per three seat sofa. Certification applies to Nienkämper leathers and fabrics that have a minimum of 50% natural fibre content. COM's and COL's are subject to approval. Add the extension -CAL to the model number when ordering.

*Add the width of the arms selected to the width of the sofa, see arm widths below right.

Back cushions have a foam core with Dacron wrap. Choose from two seat cushion fillings. Contract Filling is a firmer cushion. Residential Filling is a softer cushion. Both seat cushions are a combination of foam and down/feathers.

Model # 6
2 New York Arms
6¾ W



Model # 7
2 Seattle Arms
9¾ W

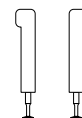

Model # 8
2 Boston Arms
10¾ W

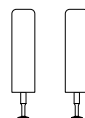

LOUNGE SEATING

Eden® with Legs Designer – Nienkämper

— CDN Only —

Model Number	Seat H"	Arm H"	* does not include arms			Fabric Yds.	Leather Sq. Ft.	COM	COL	Neather	Verde	Grano	Cremoso	Knoll Textiles			
			W"	D"	H"									1	2	3	4

SMALL OTTOMAN

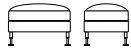

12980

27 ¼ 19 ¾ 17 2 ½ 41

1,980 2,070 2,340 3,700 4,155 4,340 2,335 2,675 3,055 3,420

LARGE OTTOMAN

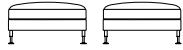

12990

34 ¾ 34 ¾ 17 3 ½ 50

2,415 2,540 2,855 4,480 5,015 5,245 2,905 3,385 3,915 4,440

LOUNGE WITH CLOSING ELEMENT

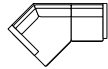

Left closing element

1294_ 17 24 ¼ 83 ¾ 56 ¼ 30 ¾

COM cushions & frame
8 ⅔ yds 7 yds

(Model #6) New York Arm, fully upholstered	13	213
(6) New York Arm, COM cushions, leather frame	6 ¾	93
(Model #7) Seattle Arm, fully upholstered	13 ½	212
(7) Seattle Arm, COM cushions, leather frame	6 ¾	93
(Model #8) Boston Arm, fully upholstered	13 ½	215
(8) Boston Arm, COM cushions, leather frame	6 ¾	96

13,230	13,905	14,685	20,160	21,995	22,710	15,030	16,815	18,775	20,710
	13,905		16,685	17,590	17,945				
13,510	14,165	15,005	20,490	22,330	23,070	15,350	17,175	19,185	21,165
	14,165		17,020	17,945	18,320				
13,345	14,000	14,840	20,410	22,285	23,025	15,180	17,010	19,025	21,000
	14,000		18,035	17,890	18,255				

SMALL TWO SEAT WITH CLOSING ELEMENT

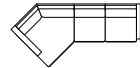

Left closing element

1295_ 17 24 ¼ 111 ¼ 56 ¼ 30 ¾

COM cushions & frame
8 yds 9 ⅔ yds

(Model #6) New York Arm, fully upholstered	17	267
(6) New York Arm, COM cushions, leather frame	8	112
(Model #7) Seattle Arm, fully upholstered	17 ½	264
(7) Seattle Arm, COM cushions, leather frame	8	110
(Model #8) Boston Arm, fully upholstered	17 ½	269
(8) Boston Arm, COM cushions, leather frame	8	114

15,760	16,540	17,670	24,135	26,370	27,220	18,100	20,430	22,995	25,530
	16,540		19,795	20,855	21,280				
16,020	16,825	17,965	24,490	26,710	27,600	18,405	20,780	23,400	25,980
	16,825		20,150	21,225	21,660				
15,870	16,660	17,815	24,395	26,635	27,545	18,255	20,635	23,250	25,830
	16,660		20,055	21,170	21,600				

Eden series passes CAL 133 certified for an upcharge of \$485 list per ottoman. Certification applies to Nienkämper leathers and fabrics that have a minimum of 50% natural fibre content. COM's and COL's are subject to approval. Add the extension -CAL to the model number when ordering.

*Add the width of the arm selected to the width of the sofa, see arm widths below right.

Back cushions have a foam core with Dacron wrap. Choose from two seat cushion fillings. Contract Filling is a firmer cushion. Residential Filling is a softer cushion. Both seat cushions are a combination of foam and down/feathers.

Model #12958

Small two seat with closing element



Model # 6
1 New York Arm
3 ¾ W



Model # 7
1 Seattle Arm
4 ¾ W

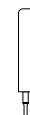

Model # 8
1 Boston Arm
5 ¾ W



LOUNGE SEATING

Elite Designer - Nienkämper

Model Number	Seat H"	W"	D"	H"	Fabric		COM	COL	Neather	Verde	Grano	Cremoso	— CDN Only — Knoll Textiles			
					Yds.	Sq.Ft.							1	2	3	4

ELITE CHAIR WITH FIXED BASE

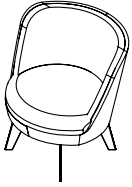

15411	17	28	27½	30	2¾	50	3,195	3,360	3,460	4,685	4,930	5,050	3,580	3,955	4,375	4,785
--------------	----	----	-----	----	----	----	-------	-------	-------	-------	-------	-------	-------	-------	-------	-------

ELITE CHAIR WITH SWIVEL BASE

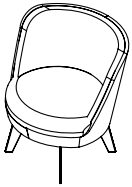

15412	17	28	27½	31¼	2¾	50	3,805	3,960	4,060	5,290	5,535	5,650	4,180	4,565	4,980	5,385
--------------	----	----	-----	-----	----	----	-------	-------	-------	-------	-------	-------	-------	-------	-------	-------

Model # 15411



Standard features:

- Interior clearance of the seat is 24"W x 20"D
- back with 2" thick lumbar foam wedge
- swivel base is standard with 180 degree swivel and memory return
- steel base is standard in Silver powder coat PC-01 or Black powder coat PC-06

LOUNGE SEATING

Expo 67 Chair Designer - Christen Sorensen

Model Number	Seat H"	W"	D"	H"	Fabric		COM	COL	Neather	Verde	Grano	Cremoso	— CDN Only — KnollTextiles			
					Yds.	Sq.Ft.							1	2	3	4

EXPO 67 CHAIR



10264	16	31	27	30½	1¼	23	2,920	3,075	3,040	3,655	3,765	3,820	3,100	3,270	3,455	3,640
--------------	----	----	----	-----	----	----	-------	-------	-------	-------	-------	-------	-------	-------	-------	-------

Model # 10264



Standard features:

- Moulded plywood frame in natural beech veneer finish
- Seat and back cushions with polyurethane foam
- Polished aluminum swivel base on glides

LOUNGE SEATING

Godbout Designer – charles godbout

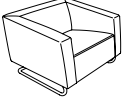
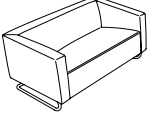
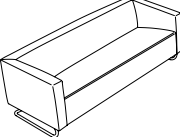
														— CDN Only —			
Model Number	Seat H"	Arm H"	W"	D"	H"	Fabric Yds.	Leather Sq.Ft.	COM	COL	Verde	Grano	Cremoso	Knoll Textiles				
													1	2	3	4	
LOUNGE CHAIR																	
	12201	14	22½	33	30	25¼	4	75	4,715	4,960	6,995	7,650	7,895	5,270	5,820	6,425	7,020
TWO SEAT SOFA																	
	12202	14	22½	56	30	25¼	6	110	5,800	6,100	9,165	10,105	10,470	6,630	7,450	8,355	9,250
THREE SEAT SOFA																	
	12203	14	22½	82	30	25¼	7½	140	6,980	7,335	11,275	12,470	12,935	8,015	9,040	10,175	11,290

Standard Features

- Plywood frame construction
- Seat and back are webbed
- Polyurethane foam
- Fortrel® on seat, back and arms
- Reinforced tubular steel base in chrome powder coat finish

Distinct faceted look in contemporary style and comfort with a sweeping tubular base.

LOUNGE SEATING

HAB™ Designer – brigitte shim and howard sutcliffe

Model Number	Seat H"	Arm H"	W"	D"	H"	Fabric Yds.	Leather Sq. Ft.	COM	COL	Verde	Grano	Cremoso
CHAIR												
	13201 Wood											
	15	23½	35½	30¼	32½	3	40		4,430			
	13202 With upholstered seat and back pad											
							12		4,870	5,325	5,430	5,480
	13203 With upholstered arm pad											
		Seat and back pad only							4,770	5,180	5,285	5,330
		Arm pad only							490	920	1,040	1,080
									375	785	900	920



The HAB™ Chair is available in veneered molded plywood with upholstered pad for seat and back in leather, fabric or vinyl and a steel base.

The HAB™ Chair is perfect for large public spaces, as it commands a presence and is a beautiful piece of sculptured-looking wood whether approached from the front or back.

LOUNGE SEATING

Heartbeat Designer - Karim Rashid

Model Number	Seat H"	W"	D"	H"	Fabric Yds.	Leather Sq.Ft.	COM	COL	Neather	Verde	Grano	Cremoso	— CDN Only — KnollTextiles			
													1	2	3	4

HEARTBEAT CONVEX ELEMENT

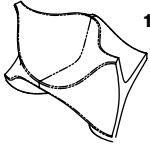

10401	17	51	37 $\frac{3}{4}$	31 $\frac{1}{2}$	5 $\frac{1}{2}$	130	4,280	4,500					5,040	5,800	6,630	7,445
--------------	----	----	------------------	------------------	-----------------	-----	-------	-------	--	--	--	--	-------	-------	-------	-------

HEARTBEAT CONCAVE ELEMENT

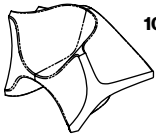

10402	17	54 $\frac{1}{4}$	32	31 $\frac{1}{2}$	5 $\frac{1}{2}$	130	4,280	4,500					4,975	5,655	6,415	7,155
--------------	----	------------------	----	------------------	-----------------	-----	-------	-------	--	--	--	--	-------	-------	-------	-------

HEARTBEAT STRAIGHT ELEMENT

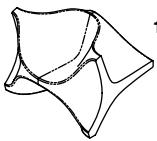

10403	17	40	35	31 $\frac{1}{2}$	5 $\frac{1}{2}$	130	4,070	4,275					4,830	5,590	6,420	7,235
--------------	----	----	----	------------------	-----------------	-----	-------	-------	--	--	--	--	-------	-------	-------	-------

HEARTBEAT CONVEX TABLE ELEMENT

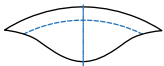

		W"	D"	Thickness"	
10404/2	Veneer	35 $\frac{5}{16}$	12 $\frac{3}{16}$	1 $\frac{1}{4}$	1,320
10404/5	P-Lam	35 $\frac{5}{16}$	12 $\frac{3}{16}$	1 $\frac{1}{4}$	1,175

HEARTBEAT CONCAVE TABLE ELEMENT

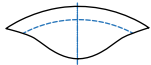

10405/2	Veneer	32 $\frac{5}{16}$	11 $\frac{9}{16}$	1 $\frac{1}{4}$	1,320
10405/5	P-Lam	32 $\frac{5}{16}$	11 $\frac{9}{16}$	1 $\frac{1}{4}$	1,175

Standard features:

- Rigid core frame with durable foam cover.
- Convex/Concave/Straight sofa elements can be arranged in limitless quantity and configuration to create double sided seating.
- Optional Convex/Concave table element with 3" taper edge mounts between sofa elements to frame with metal support.
- Optional dual USB Charger can be added to underside of table..

Note:

Fabric with 4 way stretch is recommended on Heartbeat chair, COM should be approved by Nienkämper factory.



LOUNGE SEATING

Heartbeat Designer - Karim Rashid

Heartbeat Layout

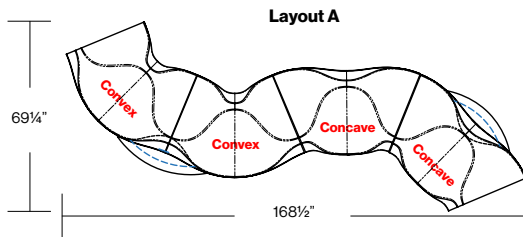
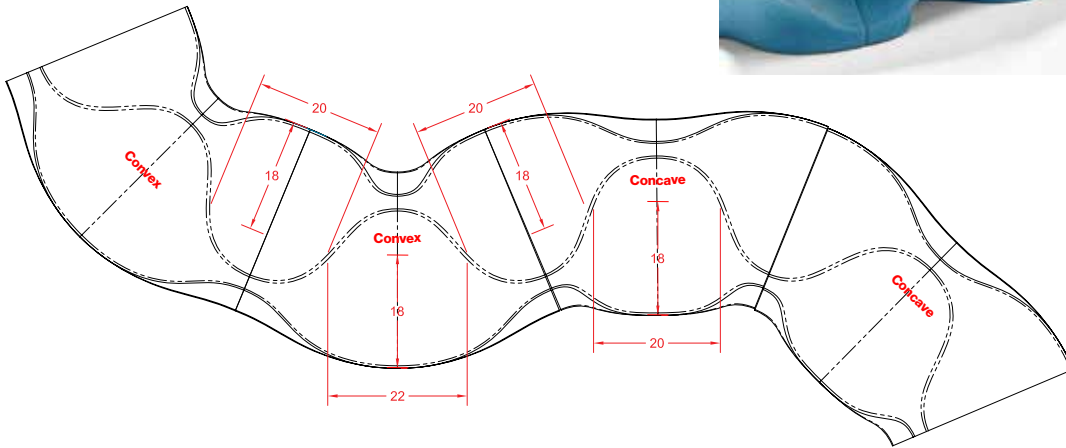

Layout "A" consists of:
 4 Sofa Elements & 2 Table Elements providing a total of 7 Seats
 From left to right: Convex Sofa Element #10401, Convex Table Element #10404/5, Convex Sofa Element #10401, Concave Sofa Element #10402, Concave Sofa Element #10402, Concave Table Element #10405/5

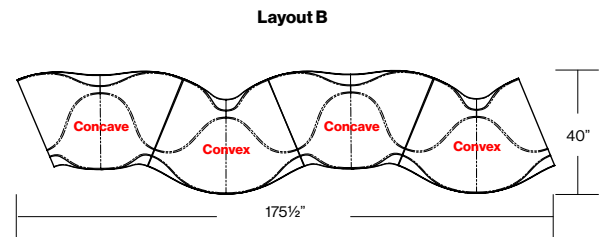

Layout "B" consists of:
 4 Sofa Elements providing a total of 7 Seats
 From left to right: Concave Sofa Element #10402, Convex Sofa Element #10401, Concave Sofa Element #10402, Convex Sofa Element #10401

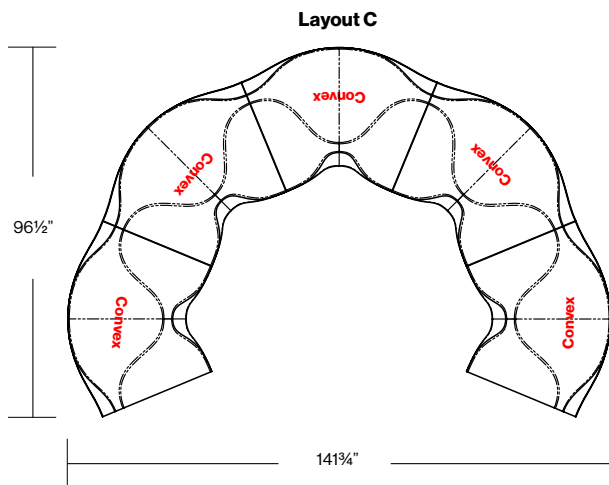

Layout "C" consists of:
 5 Sofa Elements providing a total of 9 Seats
 From left to right: Convex Sofa Element #10401, Convex Sofa Element #10401, Convex Sofa Element #10401, Convex Sofa Element #10401, Convex Sofa Element #10401

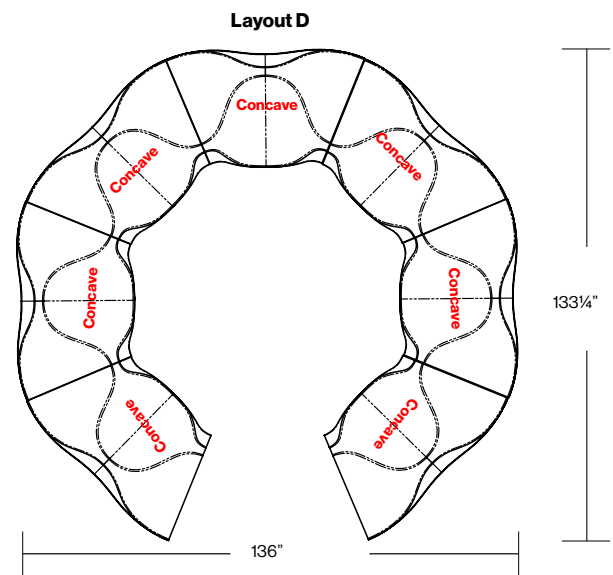

Layout "D" consists of:
 7 Sofa Elements providing a total of 13 Seats
 From left to right: Concave Sofa Element #10402, Concave Sofa Element #10402, Concave Sofa Element #10402, Concave Sofa Element #10402, Concave Sofa Element #10402, Concave Sofa Element #10402, Concave Sofa Element #10402

LOUNGE SEATING

Ingmar Chair on Legs Designer – Nienkämper

Model Number	Seat		Arm H"	W"	D"	H"	Fabric Yds.	Leather Sq. Ft.	— CDN Only — Knoll Textiles							
	H"	H"							COM	COL	Verde	Grano	Cremoso	1	2	3

INGMAR CHAIR WITH CHANNEL SLING



13901	16½	21½	25	26	34½	1½	18	3,375	3,545	4,035	4,140	4,185	3,585	3,790	4,020	4,240
--------------	-----	-----	----	----	-----	----	----	-------	-------	-------	-------	-------	-------	-------	-------	-------

INGMAR CHAIR WITH SADDLE LEATHER SLING



13902	16½	21½	25	26	34½	1½	18	specify Brown (IVT05) or Black (IVT06)								
									3,810							

INGMAR CHAIR WITH MESH SLING



13903	16½	21½	25	26	34½	1½	18	specify Black (IM01), Racing Green (IM02), or Beige (IM03)								
									2,940							

Standard Features

- natural cherry, maple or walnut frame
- stained to match available: wood finish available in standard Nienkämper
- stains; to match custom stain add \$600 list per each stain colour
- channel sling available in fabrics and leathers
- saddle leather sling available in Brown (IVT05) or Black (IVT06)
- mesh sling available in Black (IM01), Racing Green (IM02) or Beige (IM03)

Model # 13901
Ingmar with Padded Sling



Model # 13902
Ingmar with Saddle Leather Sling



Model # 13903
Ingmar with Mesh Sling



LOUNGE SEATING

Isola 8 Designer – Karim Rashid

Model Number	Seat H"	W"	D"	H"	Fabric Yds.	Leather Sq. Ft.	COM	COL	Verde	Grano	Cremoso	— CDN Only — Knoll Textiles			
												1	2	3	4

ISOLA 8

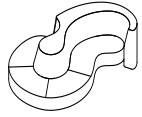

10210

Fully	16	110	70	32	15 ½	126
Back					8 ½	153
Seat					7	280

14,680	15,425	22,275	24,795	25,645	16,815	18,945	21,280	23,585
--------	--------	--------	--------	--------	--------	--------	--------	--------

Frame:

FSC plywood .

Seat and Back:

Soy based foam and fortrel.

Base:

FSC Mdf Base.



LOUNGE SEATING

J + J Studio Sofa Designer - MSDS Studio

— CDN Only —

Model Number	Seat H"	W"	D"	H"	Fabric		Leather				Knoll Textiles			
					Yds.	Sq.Ft.	COM	COL	Neather	Verde	Grano	Cremoso	1	2

J + J STUDIO LOW BACK LOUNGE CHAIR

	10271	17	35	30 3/4	33	Fully upholstered	6	108	4,915	5,165	5,480	8,025	8,550	8,805	5,750	6,570	7,475	8,370
						COM cushions, leather frame	3	52	5,165	6,590	6,865	6,985						

J + J STUDIO LOW BACK 2 SEAT SOFA

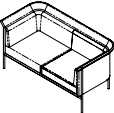
	10272	17	59	30 3/4	33	Fully upholstered	8 1/2	153	7,180	7,540	7,970	11,600	12,340	12,715	8,350	9,520	10,800	12,065
						COM cushions, leather frame	4 1/4	75	7,540	9,585	9,960	10,140						

J + J STUDIO LOW BACK 3 SEAT SOFA

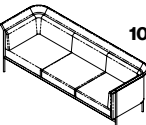
	10273	17	85	30 3/4	33	Fully upholstered	11 3/4	212	8,660	9,090	9,745	14,715	15,735	16,240	10,280	11,890	13,670	15,415
						COM cushions, leather frame	6 3/4	90	9,090	11,480	11,910	12,130						

J + J STUDIO HIGH BACK LOUNGE CHAIR

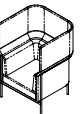
	10275	17	35	30 3/4	49	Fully upholstered	8 1/4	149	5,905	6,190	6,675	10,140	10,865	11,220	7,035	8,175	9,415	10,645
						COM cushions, leather frame	3	95	6,190	8,705	9,170	9,400						

J + J STUDIO HIGH BACK 2 SEAT SOFA

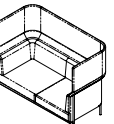
	10276	17	59	30 3/4	49	Fully upholstered	11 1/2	207	8,620	9,045	9,690	14,535	15,530	16,030	10,200	11,780	13,515	15,225
						COM cushions, leather frame	4 1/4	130	9,045	12,495	13,120	13,425						

J + J STUDIO HIGH BACK 3 SEAT SOFA

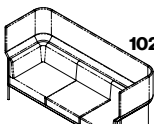
	10277	17	85	30 3/4	49	Fully upholstered	15 1/4	275	10,385	10,905	11,800	18,205	19,530	20,190	12,485	14,585	16,885	19,155
						COM cushions, leather frame	6 3/4	153	10,905	14,970	15,705	16,065						

Standard features:

- Solid maple and plywood construction frame wrapped with foam
- Seat and back cushions have molded foam inside and wrapped in Dacron.
- Exposed steel frame available in clear coated raw finish, polished chrome, brushed chrome and black powder coat finish.

Model # 10277 J & J Studio high back 3 seat sofa



Model # 10273 J & J Studio low back 3 seat sofa

Frame upholstered in Ecopell leather, Blueberry EC700



LOUNGE SEATING

Kloud® Designer – Karim Rashid

— CDN Only —

Model Number	Seat Arm		W"	D"	H"	Fabric Yds.	Leather Sq. Ft.	COM	COL	Verde	Grano	Cremoso	Knoll Textiles			
	H"	H"											1	2	3	4

CHAIR



Fully upholstered

14981	17	24½	38	28½	31	4½	81	2,955	3,105	5,370	6,005	6,265	3,570	4,190	4,875	5,545
--------------	----	-----	----	-----	----	----	----	-------	-------	-------	-------	-------	-------	-------	-------	-------

TWO SEAT SOFA



Fully upholstered

14984	17	24½	63	28½	31	6	108	5,115	5,370	8,175	9,255	9,975	5,945	6,770	7,675	8,570
--------------	----	-----	----	-----	----	---	-----	-------	-------	-------	-------	-------	-------	-------	-------	-------

THREE SEAT SOFA

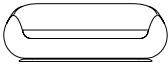

Fully upholstered

14987	17	24½	86	28½	31	7½	135	7,560	7,940	11,470	12,850	13,580	8,595	9,625	10,760	11,875
--------------	----	-----	----	-----	----	----	-----	-------	-------	--------	--------	--------	-------	-------	--------	--------

Kloud Collection passes CAL 133 certified for an upcharge of \$440 list per chair, \$870 list per 2 seat sofa and \$1,305 list per 3 seat sofa. Certification applies to Nienkämper leathers and fabrics that have a minimum of 50% natural fibre content. COM's and COL's are subject to approval. Add the extension -CAL to the model number when ordering.

Laminated wood base frame with rubber webbing under the fixed cushion. The foam body is supported with a tubular steel frame inside.

The seat and back are polyurethane foam covered in Fortrel®. Upholstered in leather or fabric.

The swivel base is painted silver. The swivel base can be upholstered to match the frame;
 add ⅔ yds 6 sq. ft. chair
 add ⅔ yds 12 sq. ft. two seat sofa
 add 1½ yds 18 sq. ft. three seat sofa







The curvaceous shape and soft molded foam of the Kloud chair are conducive to fabrics with some stretch and minimum pattern. COM fabrics should be approved by customer service. (800.668.9318)



LOUNGE SEATING

Kloud® Serpentine™ Designer – Karim Rashid

— CDN Only —

	Model Number	Seat H"	Arm H"	W"	D"	H"	Fabric Yds.	Leather Sq.Ft.	COM	COL	Verde	Grano	Cremoso	Knoll Textiles			
														1	2	3	4
CONVEX																	
Right end																	
	14994	17	25 3/4	73	28 1/2	30 1/2	6 3/4	122	4,785	5,010	8,255	9,550	9,950	5,715	6,645	7,660	8,665
Centre element																	
	14991	17		54	28 1/2	30 1/2	4 3/4	86	3,160	3,320	5,610	6,530	6,800	3,815	4,465	5,185	5,895
Left end																	
	14993	17	25 3/4	73	28 1/2	30 1/2	6 3/4	122	4,785	5,010	8,255	9,550	9,950	5,715	6,645	7,660	8,665
CONCAVE																	
Right end																	
	14997	17	25 3/4	67	28 1/2	30 1/2	7	126	5,085	5,330	8,675	10,005	10,415	6,045	7,005	8,065	9,110
Centre element																	
	14992	17		52	28 1/2	30 1/2	5	90	3,495	3,675	6,080	7,015	7,325	4,180	4,870	5,620	6,365
Left end																	
	14996	17	25 3/4	67	28 1/2	30 1/2	7	126	5,085	5,330	8,675	10,005	10,415	6,045	7,005	8,065	9,110
STRAIGHT																	
	14995	17		24	28 1/2	30 1/2	2 1/2	45	2,915	3,055	3,590	3,845	3,930	3,265	3,600	3,980	4,350

Frame:

Laminated wood base frame with rubber webbing under the fixed cushion. The foam body is supported with a tubular steel frame inside.

Seat and Back:

The seat and back are polyurethane foam, seat covered in Fortrel®. Upholstered in leather or fabric.

Base:

The base is painted silver.

The curvaceous shape and soft molded foam of the Kloud chair are conducive to fabrics with some stretch and minimum pattern. COM fabrics should be approved by customer service. (800.668.9318)

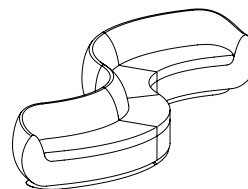

Consists of (from Left to Right when facing) :

- 1 Convex Left End **14993**
- 1 Convex Centre Element **14991**
- 1 Concave Centre Element **14992**
- 1 Concave Right End **14997**

LOUNGE SEATING

LCS Club Designer – Nienkamper

— CDN Only —
Knoll Textiles

Model Number	Seat H"	W"	D"	H"	Fabric Yds.	Leather Sq. Ft.	COM	COL	Neather	Verde	Grano	Cremoso	1	2	3	4
--------------	---------	----	----	----	-------------	-----------------	-----	-----	---------	-------	-------	---------	---	---	---	---

LCS CLUB CHAIR

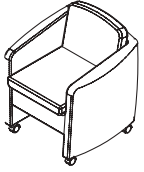

11005	15	30	31	26	6.75	120	3080	3240	3695	6505	6915	7325	3505	3925	4385	4865
-------	----	----	----	----	------	-----	------	------	------	------	------	------	------	------	------	------

Model # 11005
LCS Club Chair



Standard Features

- The reclining feature that allows for the seat and back to change simply by leaning back. Casters allow the chair to move freely.

LOUNGE SEATING

Leaf Designer - busk + hertzog

— CDN Only —

Model Number	Seat H"	W"	D"	H"	Fabric Yds.	Leather Sq.Ft.	COM	COL	Neather	Verde	Grano	Cremoso	Knoll Textiles			
													1	2	3	4

LEAF CHAIR



10310	17	36½	28	25¼	2½	45	3,245	3,395	3,450	4,380	4,580	4,675	3,590	3,930	4,315	4,680
-------	----	-----	----	-----	----	----	-------	-------	-------	-------	-------	-------	-------	-------	-------	-------

Model # 10310



Standard features:

- Seat with plywood shell
- Soy based flexible polyurethane foam for seat & back
- Polished chrome base

Fabric to be upholstered on Leaf Chair needs to be approved by Nienkämper Factory, please contact Customer Service at 800 668 9318 for our fabric approval list.



LOUNGE SEATING

LINQ Designer - Nienkämper

— CDN Only —

Model Number	Seat H"	W"	D"	H"	Fabric Yds.	Leather Sq. Ft.	COM	COL	Neather	Verde	Grano	Cremoso	Knoll Textiles			
													1	2	3	4

LINQ SEAT WITH BACK MODULE

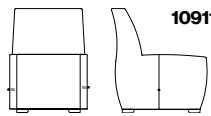
	10911	16 ½	22	32	29 ½	3	54	2,295	2,400	2,570	3,765	4,250	4,410	2,710	3,125	3,570	4,025
---	--------------	------	----	----	------	---	----	-------	-------	-------	-------	-------	-------	-------	-------	-------	-------

LINQ SEAT MODULE

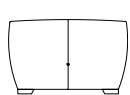
	10912		22	26	16 ½	2 ¼	40	1,375	1,470	1,590	2,465	2,830	2,950	1,680	1,985	2,335	2,670
---	--------------	--	----	----	------	-----	----	-------	-------	-------	-------	-------	-------	-------	-------	-------	-------

LINQ ARM

	10913		5 ½	26	21	1 ½	27	945	1,040	1,095	1,690	1,930	2,015	1,165	1,365	1,595	1,815
---	--------------	--	-----	----	----	-----	----	-----	-------	-------	-------	-------	-------	-------	-------	-------	-------

LINQ TABLE

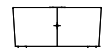
	10915		22	26	12 ¼			Paint									
								4,330									

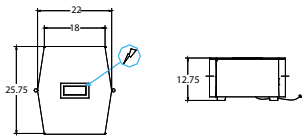

								Wood									
								5,610									

SIMPLE POP UP FORUM

(4 power pre-wired with 72 cord)

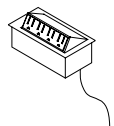

8174

								885									
--	--	--	--	--	--	--	--	-----	--	--	--	--	--	--	--	--	--

Frame is constructed of FSC Plywood core with molded foam. Any number of the three modules or table can be combined for different effects. The flexible hinge mechanism allows easy reconfiguration into any combination of straight, concave or convex layouts.

The table is available in white, silver, or black paint finish or any standard wood veneer and finishes.

Contact Customer Services at 800 668 9318 for options of other Simple Pop-up Forum

LINQ Sofa

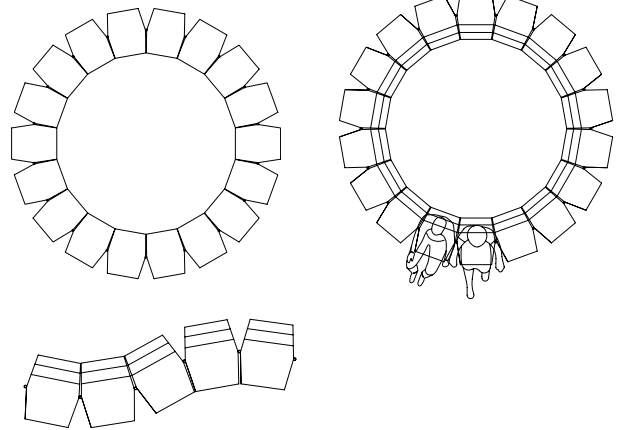

LOUNGE SEATING

LolliPOP Designer - Robin Bush 1960

— CDN Only —

Model Number	Seat H"	W"	D"	H"	Fabric Yds.	Leather Sq.Ft.	COM	COL	Neather	Verde	Grano	Cremoso	Knoll Textiles			
													1	2	3	4

LOLLIPOP 2 SEATER

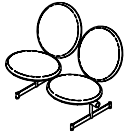

10252	18	45	33	34	3	54											
					Seat	1¼											
					Back	1¾											

4,770	5,010	5,055	6,465	6,740	6,880	5,180	5,595	6,040	6,490
-------	-------	-------	-------	-------	-------	-------	-------	-------	-------

LOLLIPOP 3 SEATER

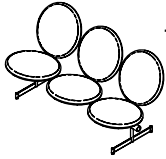

10253	18	69	33	34	4½	81											
					Seat	1¾											
					Back	2¾											

6,055	6,355	6,490	8,535	8,950	9,150	6,680	7,300	7,980	8,650
-------	-------	-------	-------	-------	-------	-------	-------	-------	-------

LOLLIPOP 4 SEATER

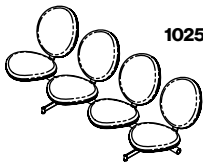

10254	18	93	33	34	6	108											
					Seat	2½											
					Back	3½											

7,275	7,630	7,840	10,530	11,080	11,355	8,105	8,925	9,830	10,730
-------	-------	-------	--------	--------	--------	-------	-------	-------	--------

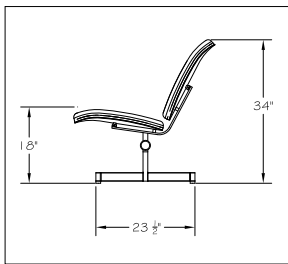

Side elevation

Model # 10252
LolliPOP 2 Seater



Model # 10253
LolliPOP 3 Seater front



Model # 10253
LolliPOP 3 Seater back



Model # 10254
LolliPOP 4 Seater



Standard Features:

- Each seat: 21" w x 22" d
- Plywood seat pan with soy based polyurethane foam
- Metal base with black powder coat horizontal steel bar and brushed nickel foot

LOUNGE SEATING

Lucerne Designer – Robert Haussmann

— CDN Only —

Model Number	Seat H"	Arm H"	W"	D"	H"	Fabric Yds.	Leather Sq.Ft.	COM	COL	Verde	Grano	Cremoso	Knoll Textiles			
													1	2	3	4

LOUNGE CHAIR

302	19½	25½	36	31¾	30½	6	105	8,175	8,570	12,110	13,145	13,545	9,000	9,825	10,730	11,625
------------	-----	-----	----	-----	-----	---	-----	-------	-------	--------	--------	--------	-------	-------	--------	--------

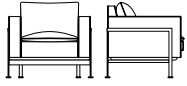

TWO SEAT SOFA

302-2	19½	25½	60	31¾	30½	9½	163	12,400	13,010	18,500	20,110	20,755	13,705	15,010	16,445	17,860
--------------	-----	-----	----	-----	-----	----	-----	--------	--------	--------	--------	--------	--------	--------	--------	--------

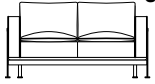

THREE SEAT SOFA

302-3	19½	25½	84	31¾	30½	12½	221	16,730	17,570	25,010	27,180	28,055	18,450	20,160	22,050	23,910
--------------	-----	-----	----	-----	-----	-----	-----	--------	--------	--------	--------	--------	--------	--------	--------	--------

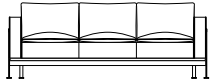

Model #302



Model #302-2



The solid bar stock steel frame is finished in mirror polished chrome. Loose seat and back cushions are down filled.

LOUNGE SEATING

Max™ Designer – Mark Müller

— CDN Only —

Model Number	Seat H"	Arm H"	W"	D"	H"	Fabric Yds.	Leather Sq.Ft.	COM	COL	Neather	Verde	Grano	Cremoso	Knoll Textiles			
														1	2	3	4

ARMLESS LOUNGE CHAIR



1110	16 ½		23	33	29	2 ½	42	2,780	2,925	3,070	4,350	4,770	4,945	3,125	3,465	3,845	4,220
------	------	--	----	----	----	-----	----	-------	-------	-------	-------	-------	-------	-------	-------	-------	-------

LOUNGE CHAIR



1111_	16 ½	24 ½	33 ½	33	29												
-------	------	------	------	----	----	--	--	--	--	--	--	--	--	--	--	--	--

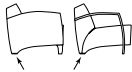

(Model #1) Closed upholstered arm	78	4,620	4,870	5,250	7,555	8,320	8,630	5,385	6,140	6,970	7,790						
(Model #4) Open wood arm	42	3,670	3,845	3,950	5,245	5,655	5,810	4,020	4,355	4,735	5,105						
(Model #5) Wood arm, upholstered panel	73	4,200	4,410	4,815	6,930	7,650	7,940	4,960	5,715	6,545	7,360						
(Model #6) Wood arm, wood panel	38	4,670	4,900	4,960	6,105	6,480	6,615	5,015	5,355	5,735	6,110						

wood level
ebonized unless specified

TWO SEAT SOFA

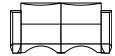

1112_	16 ½	24 ½	58	33	29												
-------	------	------	----	----	----	--	--	--	--	--	--	--	--	--	--	--	--

(Model #1) Closed upholstered arm	120	6,790	7,130	7,605	11,285	12,470	12,945	7,795	8,785	9,885	10,960						
(Model #4) Open wood arm	80	5,810	6,110	6,285	8,795	9,595	9,905	6,390	6,980	7,625	8,255						
(Model #5) Wood arm, upholstered panel	111	6,370	6,695	6,865	10,520	11,625	12,050	6,960	7,540	8,185	8,815						
(Model #6) Wood arm, wood panel	76	6,860	7,180	7,320	9,690	10,430	10,730	7,440	8,025	8,665	9,305						

THREE SEAT SOFA

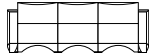

1113_	16 ½	24 ½	81	33	29												
-------	------	------	----	----	----	--	--	--	--	--	--	--	--	--	--	--	--

(Model #1) Closed upholstered arm	158	8,975	9,415	9,990	14,875	16,440	17,055	10,210	11,445	12,805	14,145						
(Model #4) Open wood arm	118	7,980	8,375	8,655	12,405	13,555	14,025	8,805	9,630	10,535	11,430						
(Model #5) Wood arm, upholstered panel	149	8,540	8,960	9,550	14,125	15,580	16,165	9,775	11,010	12,370	13,710						
(Model #6) Wood arm, wood panel	114	9,025	9,465	9,695	13,295	14,405	14,850	9,860	10,680	11,590	12,480						

Arm width and height dimensions are based on Model # 1, the fully upholstered closed arm option. Wood arms, Model # 4, # 5, and # 6 are available in standard Nienkämper veneers and stains, refer to page 12 for a listing. Add \$600 list for each custom stain required.

The solid wood front foot on the upholstered arm, Model # 1, is available in standard Nienkämper veneers and stains or ebonized, refer to page 12 for a listing. To match custom stains add \$600 list per chair, for each stain colour. An optional solid wood rear foot detail (see illustration at right) is available in standard Nienkämper veneers and stains or ebonized, refer to page 12 for a listing. Add \$290 list per chair or sofa for the rear foot.

Max series passes CAL 133 certified for an upcharge of \$440 list per chair, \$870 list per two seater sofa, and \$1305 list per three seat sofa. Certification applies to Nienkämper leathers and fabrics that have a minimum of 50% natural fibre content. COM's and COL's are subject to approval. Add the extension -CAL to the model number when ordering.

Model # 11114
and model # 11100



Model # 1
Closed
Upholstered Arm

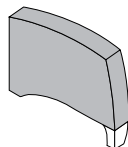

Model # 4
Open
Wood Arm

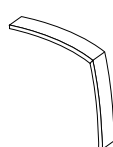

Model # 5
Wood Arm
Upholstered Panel

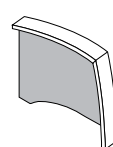

Model # 6
Wood Arm
Wood Panel

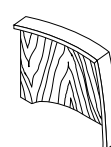

Closed Arm
Optional Rear
Wood Foot



Open Arm
Optional Rear
Wood Foot

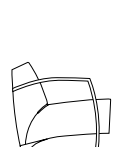

LOUNGE SEATING

Max™ Designer – Mark Müller

— CDN Only —

Model Number	Seat H"	Arm H"	W"	D"	H"	Fabric Yds.	Leather Sq.Ft.	COM	COL	Neather	Verde	Grano	Cremoso	Knoll Textiles			
														1	2	3	4

FOUR SEAT SOFA

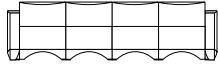

1114_ 16½ 24½ 104 33 29

(Model #1) Closed upholstered arm 10¾ 196

(Model #4) Open wood arm 7¾ 156

(Model #5) Wood arm, upholstered panel 10¾ 187

(Model #6) Wood arm, wood panel 7¾ 152

11,595	12,180	12,790	18,930	20,855	21,640	13,075	14,545	16,170	17,770
10,620	11,130	11,490	16,445	17,995	18,610	11,680	12,750	13,920	15,070
11,170	11,730	12,385	18,155	20,005	20,755	12,650	14,130	15,750	17,350
11,635	12,210	12,515	17,325	18,820	19,425	12,705	13,770	14,940	16,090

OTTOMAN



11300 16 23 23 16 1¾ 38

1,810	1,910	1,995	3,235	3,590	3,765	2,040	2,265	2,515	2,760
-------	-------	-------	-------	-------	-------	-------	-------	-------	-------

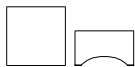

11100 16 28 28 16 2¾ 42

1,980	2,070	2,295	3,550	3,955	4,135	2,365	2,745	3,160	3,565
-------	-------	-------	-------	-------	-------	-------	-------	-------	-------

Max series passes CAL 133 certified for an upcharge of \$1825 list per four seat sofa, and \$400 list per ottoman. Certification applies to Nienkämper leathers and fabrics that have a minimum of 50% natural fibre content. COM's and COL's are subject to approval. Add the extension -CAL to the model number when ordering.

Arm width and height dimensions are based on Model # 1, the fully upholstered closed arm option. Wood arms, Model # 4, # 5, and # 6 are available in standard Nienkämper veneers and stains, refer to page 12 for a listing. Add \$600 list for each custom stain required.

The solid wood front foot on the upholstered arm, Model # 1, is available in standard Nienkämper veneers and stains or ebonized, refer to page 12 for a listing. To match custom stains add \$600 list per chair, for each stain colour. An optional solid wood rear foot detail (see illustration at right) is available in standard Nienkämper veneers and stains or ebonized, refer to page 12 for a listing. Add \$290 list per chair or sofa for the rear foot.

Model # 11131
Three seat sofa with closed upholstered arm



Model # 1
Closed Upholstered Arm

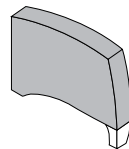

Model # 4
Open Wood Arm

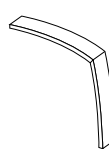

Model # 5
Wood Arm Upholstered Panel

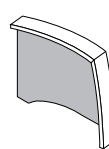

Model # 6
Wood Arm Wood Panel

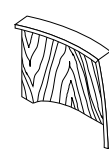

Closed Arm
Optional Rear Wood Foot



Open Arm
Optional Rear Wood Foot

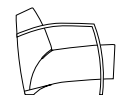

LOUNGE SEATING

Max™ Convex Designer – Mark Müller

— CDN Only —

Model Number	Seat H"	Arm H"	Front W"	Rear W"	D"	H"	Fabric Yds.	Leather Sq.Ft.	COM	COL	Neather	Verde	Grano	Cremoso	Knoll Textiles			
															1	2	3	4

LOUNGE



1121_	16 ½	24 ¼	38 ½	29	34 ¾	29													
(Model #1) Closed upholstered arm							5 ¾	79	5,235	5,485	5,895	8,185	8,960	9,265	6,030	6,815	7,690	8,545	
(Model #4) Open wood arm							2 ¾	42	4,255	4,465	4,565	5,815	6,300	6,395	4,635	5,015	5,430	5,835	
(Model #5) Wood arm, upholstered panel							5 ¾	67	4,810	5,055	5,475	7,325	7,980	8,240	5,605	6,390	7,265	8,115	
(Model #6) Wood arm, wood panel							2 ¾	39	5,280	5,535	5,580	6,740	7,125	7,300	5,660	6,040	6,460	6,870	

TWO SEAT SOFA

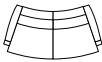

1122_	16 ½	24 ¼	67 ¼	49	37 ½	29													
(Model #1) Closed upholstered arm							7 ¾	118	8,015	8,415	8,880	12,415	13,580	14,055	9,080	10,145	11,315	12,470	
(Model #4) Open wood arm							4 ¾	81	7,015	7,370	7,555	10,070	10,850	11,170	7,665	8,320	9,040	9,745	
(Model #5) Wood arm, upholstered panel							7 ¾	106	7,560	7,955	8,435	11,535	12,320	13,000	8,635	9,700	10,870	12,020	
(Model #6) Wood arm, wood panel							4 ¾	78	8,040	8,455	8,570	10,980	11,745	12,040	8,690	9,345	10,070	10,770	

THREE SEAT SOFA

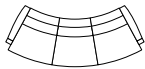

1123_	16 ½	24 ¼	93 ½	69 ¼	43 ¼	29													
(Model #1) Closed upholstered arm							9 ¾	157	10,755	11,295	11,840	16,625	18,175	18,795	12,095	13,430	14,910	16,360	
(Model #4) Open wood arm							6 ¾	120	9,790	10,280	10,550	14,290	15,465	15,930	10,725	11,645	12,665	13,675	
(Model #5) Wood arm, upholstered panel							9 ¾	145	10,350	10,865	11,440	15,765	17,195	17,770	11,690	13,035	14,510	15,955	
(Model #6) Wood arm, wood panel							6 ¾	117	10,830	11,360	11,590	15,200	16,350	16,820	11,755	12,675	13,705	14,710	

FOUR SEAT SOFA

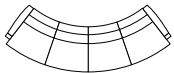

1124_	16 ½	24 ¼	128	90	48	29													
(Model #1) Closed upholstered arm							11 ¾	196	13,940	14,625	15,260	21,270	23,190	23,970	15,565	17,170	18,950	20,700	
(Model #4) Open wood arm							8 ¾	159	12,945	13,590	13,930	18,910	20,460	21,090	14,145	15,355	16,675	17,970	
(Model #5) Wood arm, upholstered panel							11 ¾	184	13,510	14,165	14,825	20,385	22,210	22,930	15,130	16,740	18,515	20,265	
(Model #6) Wood arm, wood panel							8 ¾	156	13,965	14,665	14,975	19,805	21,365	21,980	15,175	16,375	17,700	19,000	

RADIUS OTTOMAN



11200	16 ½			29	32	16 ½	2 ¾	40	2,115	2,205	2,410	3,610	4,005	4,155	2,490	2,870	3,285	3,695	
--------------	------	--	--	----	----	------	-----	----	-------	-------	-------	-------	-------	-------	-------	-------	-------	-------	--

Max series passes CAL 133 certified for an upcharge of \$440 list per chair, \$870 list per two seater sofa, \$1305 list per three seat sofa, \$1735 list per four seat sofa, and \$380 list per ottoman. Certification applies to Nienkämper leathers and fabrics that have a minimum of 50% natural fibre content. COM's and COL's are subject to approval. Add the extension -CAL to the model number when ordering.

Model # 11236
Three seat sofa with wood arm, wood panel



Model # 1
Closed Upholstered Arm

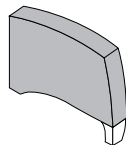

Model # 4
Open Wood Arm

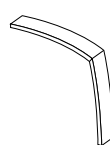

Model # 5
Wood Arm Upholstered Panel

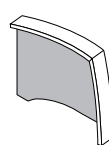

Model # 6
Wood Arm Wood Panel

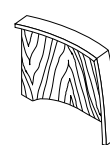

Closed Arm
Optional Rear Wood Foot



Open Arm
Optional Rear Wood Foot

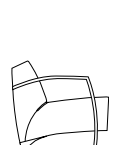

LOUNGE SEATING

Max™ Concave Designer - Mark Müller

— CDN Only —

Model Number	Seat H"	Arm H"	Front W"	Rear W"	D"	H"	Fabric Yds.	Leather Sq. Ft.	COM	COL	Neather	Verde	Grano	Cremoso	Knoll Textiles			
															1	2	3	4

TWO SEAT SOFA

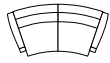

1132_ 16½ 24¼ 41¼ 69¾ 37 29

(Model #1) Closed upholstered arm	8¼	124
(Model #4) Open wood arm	5¼	87
(Model #5) Wood arm, upholstered panel	8¼	107
(Model #6) Wood arm, wood panel	5¼	84

8,015	8,415	8,945	12,645	13,885	14,360	9,150	10,285	11,525	12,755
7,015	7,370	7,605	10,285	11,130	11,490	7,740	8,460	9,250	10,030
7,560	7,955	8,485	11,575	12,625	13,050	8,695	9,835	11,080	12,305
8,040	8,455	8,640	11,185	12,020	12,345	8,770	9,495	10,280	11,065

THREE SEAT SOFA

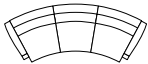

1133_ 16½ 24¼ 72½ 101½ 43 29

(Model #1) Closed upholstered arm	10¾	166
(Model #4) Open wood arm	7¾	129
(Model #5) Wood arm, upholstered panel	10¾	149
(Model #6) Wood arm, wood panel	7¾	126

10,755	11,295	11,970	16,960	18,610	19,255	12,235	13,715	15,340	16,935
9,790	10,280	10,660	14,620	15,895	16,395	10,860	11,925	13,095	14,250
10,350	10,865	11,545	15,920	17,385	17,970	11,835	13,310	14,935	16,530
10,830	11,360	11,690	15,520	16,780	17,290	11,890	12,960	14,130	15,280

FOUR SEAT SOFA

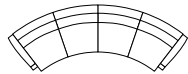

1134_ 16½ 24¼ 78½ 123¾ 48 29

(Model #1) Closed upholstered arm	12¾	208
(Model #4) Open wood arm	10¾	171
(Model #5) Wood arm, upholstered panel	12¾	191
(Model #6) Wood arm, wood panel	10¾	168

13,940	14,625	15,360	21,705	23,765	24,580	15,695	17,455	19,375	21,270
12,945	13,590	14,155	19,350	21,025	21,695	14,425	15,900	17,520	19,120
13,510	14,165	14,930	20,650	22,520	23,265	15,265	17,020	18,945	20,840
13,965	14,665	15,185	20,250	21,910	22,570	15,455	16,930	18,550	20,145

RADIUS OTTOMAN



11200 16½ 29 32 16½ 2¾ 40

2,115	2,205	2,410	3,610	4,005	4,155	2,490	2,870	3,285	3,695
-------	-------	-------	-------	-------	-------	-------	-------	-------	-------

Max series passes CAL 133 certified for an upcharge of \$870 list per two seater sofa, \$1305 list per three seat sofa, \$1735 list per four seat sofa, and \$380 list per ottoman. Certification applies to Nienkämper leathers and fabrics that have a minimum of 50% natural fibre content. COM's and COL's are subject to approval. Add the extension -CAL to the model number when ordering.

Convex and Concave Elements with wood arm and wood panel



Model # 1
Closed Upholstered Arm

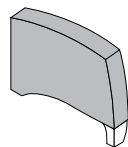

Model # 4
Open Wood Arm



Model # 5
Wood Arm Upholstered Panel

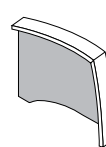

Model # 6
Closed Arm Wood Arm Wood Panel

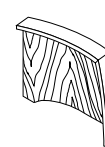

Closed Arm
Optional Rear Wood Foot



Open Arm
Optional Rear Wood Foot

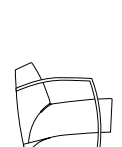

LOUNGE SEATING

Max™ Elements Designer - Mark Müller

— CDN Only —

Model Number	Seat H"	W"	D"	H"	Fabric Yds.	Leather Sq. Ft.	Knoll Textiles													
							COM	COL	Neather	Verde	Grano	Cremoso	1	2	3	4				
STRAIGHT ELEMENT OR ARMLESS END																				
	1115_	16½	23	33	29															
	(Model #0)	Armless center			2	38	2,205	2,330	2,445	3,625	4,010	4,160	2,490	2,760	3,065	3,360				
	(Model #1)	One upholstered arm			3½	58	3,400	3,580	3,805	5,575	6,140	6,370	3,885	4,370	4,895	5,420				
	(Model #4)	One open arm			2	41	3,040	3,175	3,255	4,575	4,975	5,130	3,320	3,590	3,895	4,190				
	(Model #5)	One wood arm, upholstered panel			3½	50	3,235	3,380	3,615	5,095	5,580	5,785	3,715	4,200	4,720	5,245				
	(Model #6)	One wood arm, wood panel			2	38	3,450	3,615	3,675	4,870	5,245	5,395	3,725	4,005	4,295	4,600				
	(Model #7)	Armless end with foot			2	41	2,600	2,730	2,830	4,140	4,540	4,710	2,885	3,150	3,455	3,750				

CONVEX ELEMENT OR ARMLESS END



1125_	16½	31½	33	29																
(Model #0)	Armless center			2	39	2,815	2,955	3,045	4,270	4,660	4,805	3,100	3,370	3,670	3,965					
(Model #1)	One upholstered arm			3½	59	4,010	4,215	4,395	6,225	6,790	7,025	4,485	4,975	5,500	6,020					
(Model #4)	One open arm			2	42	3,525	3,700	3,765	5,100	5,525	5,685	3,810	4,075	4,380	4,680					
(Model #5)	One wood arm, upholstered panel			3½	51	3,805	4,005	4,185	5,715	6,215	6,420	4,280	4,770	5,290	5,815					
(Model #6)	One wood arm, wood panel			2	39	4,045	4,245	4,265	5,490	5,895	6,030	4,325	4,595	4,895	5,200					
(Model #7)	Armless end with foot			2	42	3,210	3,375	3,445	4,785	5,195	5,365	3,490	3,760	4,060	4,365					

CONCAVE ELEMENT OR ARMLESS END



1135_	16½	31½	33	29																
(Model #0)	Armless center			2¾	42	2,815	2,955	3,125	4,380	4,800	4,965	3,195	3,580	4,000	4,400					
(Model #1)	One upholstered arm			4¼	62	4,010	4,215	4,480	6,330	6,940	7,185	4,590	5,175	5,815	6,455					
(Model #4)	One open arm			2¾	45	3,525	3,700	3,825	5,205	5,655	5,825	3,910	4,285	4,700	5,110					
(Model #5)	One wood arm, upholstered panel			4¼	54	3,805	4,005	4,270	5,825	6,365	6,565	4,385	4,975	5,610	6,245					
(Model #6)	One wood arm, wood panel			2¾	42	4,045	4,245	4,345	5,605	6,015	6,185	4,430	4,805	5,220	5,625					
(Model #7)	Armless end with foot			2¾	45	3,210	3,375	3,510	4,895	5,335	5,525	3,590	3,965	4,385	4,795					

Max series passes CAL 133 certified for an upcharge of \$440 list per element. Certification applies to Nienkämper leathers and fabrics that have a minimum of 50% natural fibre content. COM's and COL's are subject to approval. Add the extension -CAL to the model number when ordering.

Arm width and height dimensions are based on Model # 1, the fully upholstered closed arm option. Wood arms, Model # 4, # 5, and # 6 are available in standard Nienkämper veneers and stains, refer to page 12 for a listing. To match custom stains add \$600 list per chair, for each stain colour.

Creative or traditional shaped sectional sofas are possible by combining a variety of Max Elements.

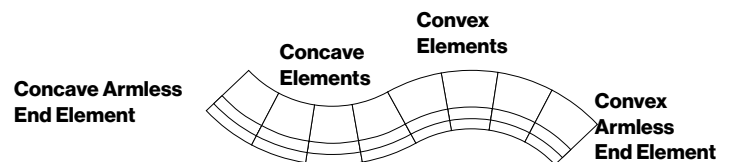

LOUNGE SEATING

Max™ Elements Designer - Mark Müller

Model Number	Seat H"	W"	D"	H"	Fabric Yds.	Leather Sq.Ft.	COM	COL	Neather	Verde	Grano	Cremoso	— CDN Only — Knoll Textiles			
													1	2	3	4

SQUARE CORNER



11160	16½	33	33	29	4¼	55	4,060	4,265	4,540	6,125	6,680	6,900	4,650	5,230	5,870	6,505
--------------	-----	----	----	----	----	----	-------	-------	-------	-------	-------	-------	-------	-------	-------	-------

RADIUS CORNER

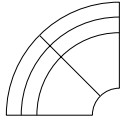

11170	16½	42	42	29	4½	64	4,535	4,765	5,050	6,925	7,555	7,805	5,155	5,770	6,455	7,120
--------------	-----	----	----	----	----	----	-------	-------	-------	-------	-------	-------	-------	-------	-------	-------

Max series passes CAL 133 certified for an upcharge \$440 list per element. Certification applies to Nienkämper leathers and fabrics that have a minimum of 50% natural fibre content. COM's and COL's are subject to approval. Add the extension -CAL to the model number when ordering.

Creative or traditional shaped sectional sofas are possible by combining a variety of Max Elements.

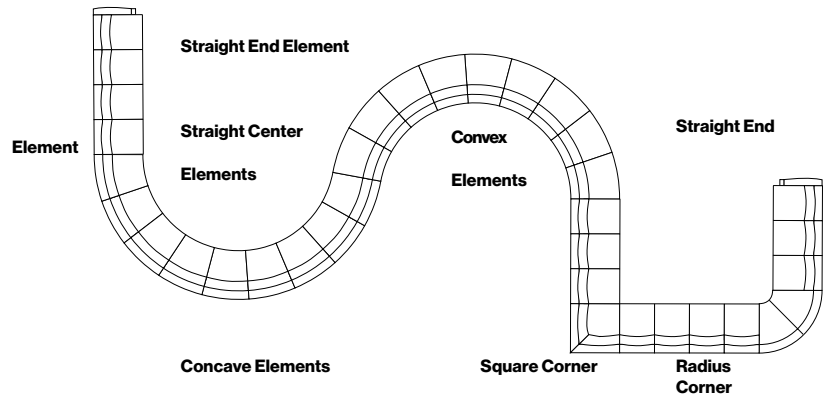

with wood arm and wood panel



LOUNGE SEATING

Max Tuxedo™ Designer - Mark Müller

— CDN Only —

Model Number	Seat H"	Arm H"	W"	D"	H"	Fabric Yds.	Leather Sq.Ft.	COM	COL	Neather	Verde	Grano	Cremoso	Knoll Textiles			
														1	2	3	4

TWO SEAT SOFA

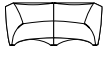

11020 16½ 29 66 33 29 10 110

9,355 9,825 10,470 13,465 14,550 14,985 10,730 12,100 13,610 15,095

THREE SEAT SOFA

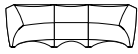

11030 16½ 29 89 33 29 12 148

11,515 12,100 12,870 17,055 18,515 19,100 13,170 14,820 16,625 18,415

FOUR SEAT SOFA

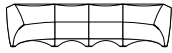

11040 16½ 29 112 33 29 14 184

13,695 14,365 15,260 20,570 22,385 23,115 15,615 17,545 19,655 21,735

FIVE SEAT L-SHAPED SOFA



11070 16½ 29 89 89 29 16¾ 229

16,415 17,240 18,300 24,985 27,235 28,135 18,720 21,025 23,555 26,050

SIX SEAT L-SHAPED SOFA

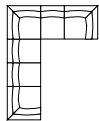

11080 16½ 29 89 112 29 18¾ 261

18,585 19,525 20,695 28,365 30,920 31,955 21,160 23,745 26,575 29,365





Model # 11030
Three seat sofa

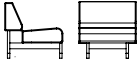
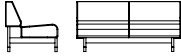

LOUNGE SEATING

Mood Collection Designer - Charles Godbout

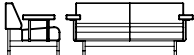
— CDN Only —

	Model Number	Seat H"	Arm H"	W"	D"	H"	Fabric Yds.	Leather Sq.Ft.	COM	COL	Verde	Grano	Cremoso	Knoll Textiles			
														1	2	3	4
LOUNGE CHAIR, ARMLESS																	
	11481	15½		29½	31	29½	2½	34	5,985	6,280	6,910	7,205	7,325	6,335	6,675	7,055	7,425
TWO SEAT SOFA, ARMLESS																	
	11482	15½		59¼	31	29½	5	58	7,930	8,320	9,510	10,020	10,205	8,625	9,310	10,065	10,805
THREE SEAT SOFA, ARMLESS																	
	11483	15½		89	31	29½	7½	83	8,575	9,005	10,840	11,590	11,840	9,610	10,640	11,775	12,885
LOUNGE CHAIR WITH ARMS																	
	11485	15½	22¼	40	31	29¾	2½	41	6,905	7,220	8,015	8,380	8,505	7,255	7,595	7,975	8,345
TWO SEAT SOFA WITH ARMS																	
	11486	15½	22¼	69¾	31	29¾	5	65	8,840	9,275	10,615	11,195	11,390	9,525	10,210	10,965	11,710
THREE SEAT SOFA WITH ARMS																	
	11487	15½	22¼	99½	31	29¾	7½	90	9,500	9,975	11,945	12,760	13,030	10,530	11,560	12,695	13,805

Model # 11481
Mood Lounge Chair, Armless



Model # 11485
Mood Lounge Chair with Arms



Standard Features

- Brushed Nickel frame
- FSC certified hardwood plywood frame
- Foam cushions with 25 percent soya content

LOUNGE SEATING

Nordic Designer - Nienkämper

— CDN Only —

Model Number	Seat H"	W"	D"	H"	Fabric Yds.	Leather Sq.Ft.	COM	COL	Neather	Verde	Grano	Cremoso	Knoll Textiles			
													1	2	3	4

NORDIC



10262	16½	28	26	29½	2	36	3,080	3,235	3,270	4,165	4,350	4,450	3,355	3,630	3,930	4,235
--------------	-----	----	----	-----	---	----	-------	-------	-------	-------	-------	-------	-------	-------	-------	-------

Model # 10262



Standard features:

- Moulded plywood frame
- Seat and back cushions with polyurethane foam
- Base is beech plywood available in natural finish and standard nienkämper paint finish
- Custom stained to match on the base is also available with upcharge

LOUNGE SEATING

Note Designer - busk + hertzog

— CDN Only —
Knoll Textiles

Model Number	Seat H"	Arm H"	W"	D"	H"	Fabric Yds.	Leather Sq.Ft.	COM	COL	Neather	Verde	Grano	Cremoso	1	2	3	4
--------------	---------	--------	----	----	----	-------------	----------------	-----	-----	---------	-------	-------	---------	---	---	---	---

NOTE CHAIR ON GLIDES

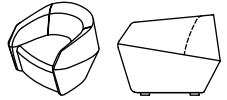
	10651	16	25¼	33	34½	27¾	5½	99	2,770	2,905	3,295	5,700	6,080	6,330	3,525	4,280	5,110	5,930
---	--------------	----	-----	----	-----	-----	----	----	-------	-------	-------	-------	-------	-------	-------	-------	-------	-------

NOTE CHAIR WITH SWIVEL DISK

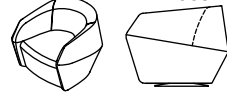
	10654	16	25¼	33	34½	27¾	6½	113	2,990	3,140	3,570	6,225	6,655	6,925	3,885	4,780	5,760	6,720
---	--------------	----	-----	----	-----	-----	----	-----	-------	-------	-------	-------	-------	-------	-------	-------	-------	-------

NOTE TWO SEAT SOFA

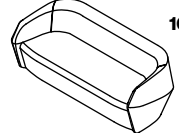
	10652	16	25¼	69	34½	27¾	8½	153	4,035	4,240	4,850	8,345	9,125	9,515	5,205	6,370	7,655	8,920
---	--------------	----	-----	----	-----	-----	----	-----	-------	-------	-------	-------	-------	-------	-------	-------	-------	-------

NOTE THREE SEAT SOFA

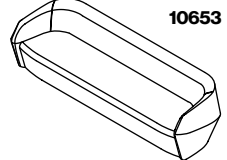
	10653	16	25¼	93	34½	27¾	9½	171	5,085	5,335	5,995	9,920	10,800	11,230	6,385	7,695	9,130	10,545
---	--------------	----	-----	----	-----	-----	----	-----	-------	-------	-------	-------	--------	--------	-------	-------	-------	--------

Standard Features:

- Frame is constructed of solid maple & FSC hardwood plywood with soy based polyurethane foam.
- Note chair is available on glides or with swivel disk in upholstery finish.
- Contrasting stitching can be specified on outside back with no upcharge.

Optional contrast stitching on outside back:

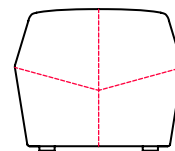

Back Elevation

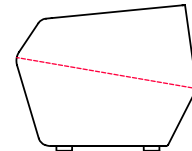

Side Elevation

Model # 10651 Note chair



Model # 10652 Note two seat sofa





Model # 10651 & 10653 Note chair & three seat sofa with Mint Stools



LOUNGE SEATING

Paris Archive Designer - Nienkämper

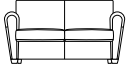
— CDN Only —

Model Number	Seat Arm		W"	D"	H"	Fabric Yds.	Leather Sq.Ft.	COM	COL	Verde	Grano	Cremoso	Knoll Textiles					
	H"	H"											1	2	3	4		
CLUB CHAIR																		
	250	17	22½	34	37	31	8	105	7,690	8,070	11,625	12,650	13,080	8,790	9,895	11,095	12,285	
SMALL TWO SEAT SOFA																		
	250-2	17	22½	57	37	31	11	144	8,685	9,130	14,080	15,490	16,060	10,205	11,715	13,375	15,015	
LARGE TWO SEAT SOFA																		
	250-2L	17	22½	73	37	31	13	170	9,265	9,730	15,635	17,305	17,970	11,060	12,845	14,805	16,740	
OTTOMAN																		
	250-5			32	32	17	4	52	2,295	2,400	4,245	4,755	4,960	2,845	3,395	4,005	4,595	

Feet are 2" high. Feet can be ordered in wood and are available in standard Nienkämper veneers and stains, refer to page 12 for a listing. Custom stains are available, add \$600 list for each custom stain required.

The price of contrasting leather is included in the COM and COL prices. The following leather square footages should be added for the welting:
 Paris Archive Club Model # 250 – 6 Sq. Ft.
 Small Two Seat Sofa Model # 250-2 – 9 Sq. Ft.
 Large Two Seat Sofa Model # 250-2L – 11 Sq. Ft.
 Ottoman Model # 250-5 – 3 Sq. Ft.

Model #250



Model #250-5



LOUNGE SEATING

Patkau Twist Designer - Patkau Architects

Model Number	Seat H"	W"	D"	H"	List Price
PATKAU TWIST					
10286	16	51	30¾ (Seat Dimensions: 51" x 23½" x 16")	30½	3,940

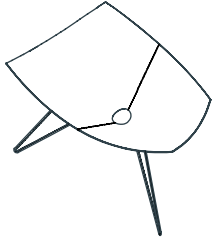

Model # 10286
Patkau Twist



Standard Features

- Seat Material: plywood
- Frame Material: stainless steel rod
- Seat Finish: standard stain & finish
- Frame Finish: brushed stainless, powder coat satin black

LOUNGE SEATING

Polo Designer – Nienkamper

Model Number	Seat H"	W"	D"	H"	Fabric Yds.	Leather Sq. Ft.	COM	COL	Verde	Grano	Cremoso	— CDN Only — Knoll Textiles			
												1	2	3	4

POLO CHAIR

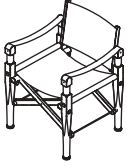

13917	17¼	22½	21	33	2	36	2970	3125	4110	4235	4350	3100	3220	3355	3500
--------------	-----	-----	----	----	---	----	------	------	------	------	------	------	------	------	------

Model # 13917
Polo Chair





Standard Features

- Solid wood legs

LOUNGE SEATING

Pullman™ Designer - Nienkämper

— CDN Only —
KnollTextiles

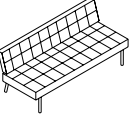
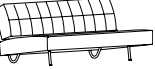
Model Number	Seat H"	W"	D"	H"	Fabric Yds.	Leather Sq.Ft.	COM	COL	Verde	Grano	Cremoso	1	2	3	4
LOUNGE CHAIR															
	15704	16	28	30	30										
	Fully upholstered - Tufted					2¼	32	3,550	3,720	4,965	5,335	5,490	3,860	4,165	4,505
Fully upholstered - Plain						2¼		3,550				3,860	4,165	4,505	4,845
TWO SEAT SOFA															
	15706	16	49	30	30										
	Fully upholstered - Tufted					3	54	5,375	5,650	7,165	7,640	7,840	5,790	6,205	6,655
Fully upholstered - Plain						3		5,375				5,790	6,205	6,655	7,100
THREE SEAT SOFA															
	15707	16	70	30	30										
	Fully upholstered - Tufted					4½	76	7,340	7,710	10,060	10,755	11,025	7,965	8,580	9,260
Fully upholstered - Plain						4½		7,340				7,965	8,580	9,260	9,935
SLEEPER SOFA															
	15701	16	80	42	30½										
	Fully upholstered - Tufted					7	112	8,025	8,430	12,210	13,320	13,745	8,990	9,950	11,005
Fully upholstered - Plain						7		8,025				8,990	9,950	11,005	12,050

Pullman Chair

Fabric yardages are based on a 54" width with no repeat, see page 6 for instructions. The base is available in a brushed nickel finish as standard; add 5% for a polished chrome finish.

Pullman Sleeper Sofa



Fabric yardages are based on a 54" width with no repeat, fabric must be railroaded, see page 6 for instructions. The base is available in a brushed nickel finish as standard; add 5% for a polished chrome finish. Measurements of the Sleeper Sofa used as a bed are: width 80" x depth 50" x height 16".



LOUNGE SEATING

Pullman™ Designer - Nienkämper

— CDN Only —

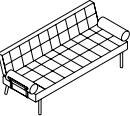
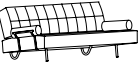
	Model Number	Seat H"	Arm H"	W"	D"	H"	Fabric Yds	Leather Sq.Ft.	COM	COL	Verde	Grano	Cremoso	Knoll Textiles			
														1	2	3	4
LOUNGE CHAIR WITH ARMS																	
	15714	17	24 ½	35	30	30											
	Fully upholstered - tufted						3¼	48	5,315	5,575	7,330	7,855	8,070	5,760	6,210	6,695	7,180
	Fully upholstered - plain						3¼		5,315					5,760	6,210	6,695	7,180
TWO SEAT SOFA WITH ARMS																	
	15715	16	24 ½	56	30	30											
	Fully upholstered - tufted						4	70	7,135	7,515	9,540	10,170	10,415	7,690	8,240	8,845	9,435
	Fully upholstered - plain						4		7,135					7,690	8,240	8,845	9,435
THREE SEAT SOFA WITH ARMS																	
	15716	16	24 ½	77	30	30											
	Fully upholstered - tufted						5½	92	9,125	9,555	12,405	13,280	13,620	9,890	10,645	11,470	12,285
	Fully upholstered - plain						5½		9,125					9,890	10,645	11,470	12,285
SLEEPER SOFA WITH ARMS																	
	15717	16	22	87	42	30 ½											
	Fully upholstered - tufted						8	128	9,785	10,280	14,025	15,830	16,340	10,885	11,990	13,190	14,380
	Fully upholstered - plain						8		9,785					10,885	11,990	13,190	14,380

Pullman Chair

Fabric yardages are based on a 54" width with no repeat, see page 6 for instructions. The base is available in a brushed nickel finish as standard; add 5% for a polished chrome finish.

Pullman Sleeper Sofa

Fabric yardages are based on a 54" width with no repeat, fabric must be railroaded, see page 6 for instructions. The base is available in a brushed nickel finish as standard; add 5% for a polished chrome finish. Measurements of the Sleeper Sofa used as a bed are: width 87" x depth 50" x height 16".



LOUNGE SEATING

Pyramid Chair Designer - Karim Rashid

Model Number	W"	D"	H"	Fabric Yds.	Leather Sq.Ft.	COM	COL	Verde	Grano	Cremoso	— CDN Only — KnollTextiles			
											1	2	3	4

PYRAMID CHAIR

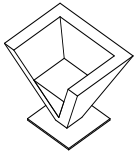

10510

Fully	38	29	26	7	126	2,540	2,675	5,955	7,115	7,500	3,505	4,465	5,525	6,565
Body				6	108									
Seat				1	18									

Frame:

FSC plywood.

Seat and Back:

Soy based foam and fortrel.

Base:

Brushed stainless steel base.



LOUNGE SEATING

Q Chair Designer - QDesign

— CDN Only —

Model Number	Seat H"	Arm H"	W"	D"	H"	Fabric		COM	COL	Neather	Verde	Grano	Cremoso	Knoll Textiles			
						Yds.	Sq.Ft.							1	2	3	4

Q LOUNGE CHAIR WITH VENEER



10051	16½	21¾	31½	31	34½	2¾	49	4,115	4,320	4,315	5,295	5,490	5,590	4,480	4,845	5,245	5,645
--------------	-----	-----	-----	----	-----	----	----	-------	-------	-------	-------	-------	-------	-------	-------	-------	-------

Q LOUNGE CHAIR - FULLY UPHOLSTERED



10053	16½	21¾	31½	31	34½	4	72	3,905	4,105	4,090	5,035	5,215	5,320	4,455	5,005	5,605	6,205
--------------	-----	-----	-----	----	-----	---	----	-------	-------	-------	-------	-------	-------	-------	-------	-------	-------

Q SIDE CHAIR WITH VENEER



10052	18	24	27½	23	34	1½	27	3,545	3,710	3,690	4,450	4,595	4,670	3,750	3,955	4,185	4,405
--------------	----	----	-----	----	----	----	----	-------	-------	-------	-------	-------	-------	-------	-------	-------	-------

Q SIDE CHAIR - FULLY UPHOLSTERED



10054	18	24	27½	23	34	3	54	3,360	3,525	3,500	4,230	4,370	4,445	3,775	4,190	4,645	5,090
--------------	----	----	-----	----	----	---	----	-------	-------	-------	-------	-------	-------	-------	-------	-------	-------

Model # 10051



Model # 10052



Standard features:

- Moulded plywood seat & arm shell
- Soy based flexible polyurethane foam
- Maple or walnut veneer with any Nienkämper stains is available for model with veneer finish (Model #10051 & #10052)
- Q Side Chair with veneer back has only seat & arm shell but a fully upholstered back
- Polished aluminum 4-star base on glides for Q Lounge chair
- Polished aluminum cross base for Q Side chair

LOUNGE SEATING

Radius Designer - Christopher Panichella

— CDN Only —

Model Number	Seat Arm			D"	H"	Fabric Yds.	Leather Sq.Ft.	COM	COL	Neather	Verde	Grano	Cremoso	KnollTextiles			
	H"	H"	W"											1	2	3	4

RADIUS LOW BACK - WITH WOOD BACK

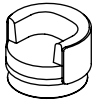

10770	16	27	33¼	33	29	3½	63	5,815	6,045	5,905	7,790	8,120	8,285	6,300	6,780	7,310	7,830
-------	----	----	-----	----	----	----	----	-------	-------	-------	-------	-------	-------	-------	-------	-------	-------

RADIUS LOW BACK - FULLY UPHOLSTERED

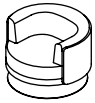

10771	16	27	33¼	33	29	4½	81	4,565	4,795	5,010	7,025	7,455	7,680	5,180	5,800	6,480	7,150
-------	----	----	-----	----	----	----	----	-------	-------	-------	-------	-------	-------	-------	-------	-------	-------

RADIUS HIGH BACK

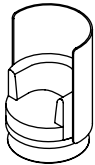

10772	16	27	33¼	33	48	6¾	122	7,190	7,555	7,865	10,940	11,575	11,895	8,120	9,045	10,070	11,075
-------	----	----	-----	----	----	----	-----	-------	-------	-------	--------	--------	--------	-------	-------	--------	--------

ACCESSORIES

TABLET ARM



12461	20	12	½	1,505
-------	----	----	---	-------

CUP HOLDER



10774	4 dia	610
-------	-------	-----

POWER

Simple Dot Forums



White receptacle, model #11867/W \$??? List	White stacked USB, model #11868/W \$??? list	Black receptacle, model #11967/B \$??? List	Black stacked USB, model # 11868/B \$??? list
---	--	---	---

Vox Simple Dot Forums with Trim



Satin nickel trim with white receptacle, model #11864NW \$285 List	Satin nickel trim with white stacked USB, model # 11865NW \$490 list	Satin nickel trim with black receptacle, model # 11864NB \$285 list	Satin nickel trim with black stacked USB, model # 11865NB \$490 list
--	--	---	--



Tablet arm available in white or silver finish

Model # 10770
Radius low back
with wood back



Radius low back upholstered in Ecopell leather Blackberry EC100

Model # 10772
Radius high back with tablet,
cup holder & power



Standard Features:

- Seat depth: 22"d
- Seat and back cushions have a foam core with Dacron wrap.
- Legs standard in mirror polish.
- Radius Low Back chair is available with wood back on exterior. Select from standard Nienkämper veneer & stains.
- Radius High Back chair is only available fully upholstered.

Optional Features:

- Tablet top available in ½" thick solid Fingerprint Resistance P-lam in pure White or Black.
- Tablet arm support in silver or white powder coat finish
- Cup holder available in polished or brushed aluminum.
- Cup holder top with leather or vinyl inset in white or black as standard.
- Power Outlet or stacked USB Charger with 72" cord in satin nickel standard

LOUNGE SEATING

Radius on Legs Designer - Christopher Panichella

— CDN Only —

Model Number	Seat Arm		W"	D"	H"	Fabric Yds.	Leather Sq. Ft.	COM	COL	Neather	Verde	Grano	Cremoso	Knoll Textiles			
	H"	H"												1	2	3	4

RADIUS LOW BACK - WITH WOOD BACK

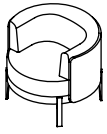

10775	16	28¼	33½	32¾	28¼	3½	63
--------------	----	-----	-----	-----	-----	----	----

5,695	5,920	5,765	7,660	7,990	8,160	6,170	6,660	7,185	7,705
-------	-------	-------	-------	-------	-------	-------	-------	-------	-------

RADIUS LOW BACK - FULLY UPHOLSTERED

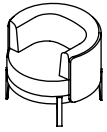

10776	16	28¼	33½	32¾	28¼	4½	81
--------------	----	-----	-----	-----	-----	----	----

4,440	4,665	4,880	6,910	7,330	7,545	5,055	5,670	6,355	7,025
-------	-------	-------	-------	-------	-------	-------	-------	-------	-------

RADIUS HIGH BACK

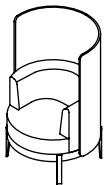

10777	16	28¼	33½	32¾	47½	6¾	122
--------------	----	-----	-----	-----	-----	----	-----

7,080	7,430	7,740	10,805	11,440	11,775	8,010	8,935	9,955	10,960
-------	-------	-------	--------	--------	--------	-------	-------	-------	--------

ACCESSORIES

TABLET ARM



12461	20	12	½
--------------	----	----	---

1,505

CUP HOLDER



10774	4 dia
--------------	-------

610

POWER

Simple Dot Forums



White receptacle, model #11867/W \$?? List

White stacked USB, model #11868/W \$?? list

Black receptacle, model #11967/B \$?? List

Black stacked USB, model #11868/B \$?? list

Simple Dot Forums with Trim



Satin nickel trim with white receptacle, model #11864NW \$285 List

Satin nickel trim with white stacked USB, model #11865NW \$490 list

Satin nickel trim with black receptacle, model #11864NB \$285 list

Satin nickel trim with black stacked USB, model #11865NB \$490 list

Model # 10777
Radius on legs



Tablet arm available in white or silver finish



Standard Features:



- Seat depth: 22"d
- Seat and back cushions have a foam core with Dacron wrap.
- Legs standard in mirror polish.
- Radius Low Back chair is available with wood back on exterior. Select from standard Nienkämper veneer & stains.
- Radius High Back chair is only available fully upholstered.

Optional Features:

- Tablet top available in ½" thick solid Fingerprint Resistance P-lam in pure White or Black.
- Tablet arm support in silver or white powder coat finish
- Cup holder available in polished or brushed aluminum.
- Cup holder top with leather or vinyl inset in white or black as standard.
- Power Outlet or stacked USB Charger with 72" cord in satin nickel standard

LOUNGE SEATING

Rowan Lounge Collection Designer - Yabu Pushelburg

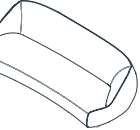
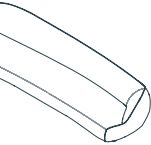
Model Number	Seat H"	W"	D"	H"	Fabric Yds.	Leather Sq.Ft.	— CDN Only — Knoll Textiles										
							COM	COL	Neather	Verde	Grano	Cremoso	1	2	3	4	
ROWAN LOUNGE CHAIR																	
 10660 on glides	16	34%	36	27%	5.5	99	4,115	4,325	4,610	6,835	7,560	10,220	4,460	4,805	5,175	5,560	
 10661 swivel base	16	34%	36	27%	5.5	99	4,275	4,490	4,780	7,005	7,730	10,390	4,620	4,975	5,340	5,725	
ROWAN LARGE LOUNGE CHAIR																	
 10662	16	52%	36	27%	6.5	117	4,725	4,965	5,320	7,935	8,450	8,970	5,075	5,425	5,795	6,175	
ROWAN 2-SEATER SOFA																	
 10663	16	82%	36	27%	7	126	5,580	5,860	6,215	9,060	9,615	10,170	6,020	6,460	6,925	7,425	
ROWAN 3-SEATER SOFA																	
 10664	16	118%	36	27%	8	144	6,980	7,330	7,705	10,985	11,620	12,255	7,485	7,990	8,525	9,090	

Standard Features:

- Constructed from soybased polyurethane foam over ridgid frame
- Sofa sits on glides
- Chairs available on glide or swivel base

Model # 10661
Rowan Arm Lounge Chair upholstered in Knoll Velvetk 784/74 Moss



Model # 10664
Rowan Lounge 3 Seater Sofa upholstered in Maharam 466420 Huddle Pottery 002



LOUNGE SEATING

Satori™ & Satori™ with Tablet Arm Designer - Mark saffell & David ritch

— CDN Only —
Knoll Textiles

Model Number	Seat H"	Arm H"	W"	D"	H"	Fabric Yds.	Leather Sq. Ft.	COM	COL	Neather	Verde	Grano	Cre moso	1	2	3	4
--------------	---------	--------	----	----	----	-------------	-----------------	-----	-----	---------	-------	-------	----------	---	---	---	---

SATORI

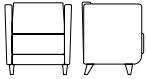

23201	17½	28½	26½	25	30	3½	52	3,070	3,220	3,465	5,020	5,540	5,745	3,550	4,035	4,565	5,085
--------------	-----	-----	-----	----	----	----	----	-------	-------	-------	-------	-------	-------	-------	-------	-------	-------

SATORI WITH LOW ARM

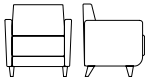

23203	17½	24¾	26½	25	30	3½	50	2,975	3,135	3,375	4,945	5,460	5,655	3,460	3,940	4,470	4,995
--------------	-----	-----	-----	----	----	----	----	-------	-------	-------	-------	-------	-------	-------	-------	-------	-------

SATORI WITH TABLET ARM



23202	17¼	24¾	30¾	24¼	30½	3½	50	4,605	4,845	5,010	6,565	7,100	7,305	5,090	5,575	6,105	6,615
--------------	-----	-----	-----	-----	-----	----	----	-------	-------	-------	-------	-------	-------	-------	-------	-------	-------



mesh pocket

Satori and Satori with Tablet Arm are available as CAL 133 certified for an upcharge of \$415 list per chair. Certification applies to Nienkämper leathers and fabrics that have a minimum of 50% natural fibre content. COM's and COL's are subject to approval. Add the extension -CAL to the model number when ordering.

Model # 23201 Satori



Model # 23202 A mesh pocket for storage and interchangeable cup holder.



Model # 23202 Satori with interchangeable tablet arm accommodates right and left-handed users.



Castors on the Satori chair make it easy to reconfigure meeting space.

Satori with Tablet Arm

Mesh pocket dimensions are 21" w x 11" h. The tablet arm is made of marine-grade plastic. Legs are cast aluminum.

Specify polished or brushed aluminum finish for tablet holder, cup holder & leg finish.

Handle is in brushed stainless steel finish

LOUNGE SEATING

Six Collection Designer - Nienkämper

— CDN Only —
Knoll Textiles

Model Number	Seat H"	Arm H"	W"	D"	H"	Fabric Yds.	Leather Sq.Ft.	COM	COL	Verde	Grano	Cremoso	1	2	3	4
--------------	---------	--------	----	----	----	-------------	----------------	-----	-----	-------	-------	---------	---	---	---	---

LOUNGE CHAIR

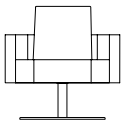

30301	16	23¾	32	28	30½	3	45	3,175	3,320	3,375	4,300	4,595	4,710	3,590	4,010	4,455	4,900
--------------	----	-----	----	----	-----	---	----	-------	-------	-------	-------	-------	-------	-------	-------	-------	-------

LOUNGE CHAIR W TABLET

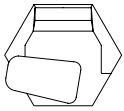

30302	16	23¾	32	28	30½	3	45	3,745	3,935	3,935	4,870	5,165	5,270	4,160	4,580	5,025	5,475
--------------	----	-----	----	----	-----	---	----	-------	-------	-------	-------	-------	-------	-------	-------	-------	-------

2 SEAT BENCH

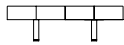

30303	17		55	31½		3	45	4,250	4,410	4,515	5,920	6,355	6,535	4,665	5,075	5,530	5,975
--------------	----	--	----	-----	--	---	----	-------	-------	-------	-------	-------	-------	-------	-------	-------	-------

3 SEAT BENCH

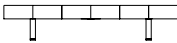

30304	17		82	31½		4½	81	4,760	4,955	5,165	7,265	7,920	8,185	5,375	5,995	6,675	7,340
--------------	----	--	----	-----	--	----	----	-------	-------	-------	-------	-------	-------	-------	-------	-------	-------

OTTOMAN



30305	17		28	27¾		1½	27	2,835	2,950	2,980	3,685	3,900	3,980	3,055	3,255	3,485	3,705
--------------	----	--	----	-----	--	----	----	-------	-------	-------	-------	-------	-------	-------	-------	-------	-------



30310	17		28	27¾		1½	27	2,125	2,235	2,260	2,960	3,175	3,265	2,335	2,535	2,760	2,980
--------------	----	--	----	-----	--	----	----	-------	-------	-------	-------	-------	-------	-------	-------	-------	-------

2 SEAT BENCH ON PEDESTALS

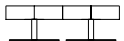

30308	17		63	31½		3	54	3,525	3,695	3,805	5,200	5,640	5,815	3,940	4,355	4,805	5,250
--------------	----	--	----	-----	--	---	----	-------	-------	-------	-------	-------	-------	-------	-------	-------	-------

3 SEAT BENCH ON PEDESTALS



30309	17		82	31½		4½	81	4,040	4,240	4,450	6,540	7,195	7,455	4,660	5,275	5,955	6,630
--------------	----	--	----	-----	--	----	----	-------	-------	-------	-------	-------	-------	-------	-------	-------	-------

Six Collection passes CAL 133 certified for an upcharge of \$415 list per chair, \$605 per 2 seat bench, \$790 per 3 seat chair and \$360 per ottoman. Certification applies to Nienkämper leathers and fabrics that have a minimum of 50% natural fibre content. COM's and COL's are subject to approval. Add the extension -CAL to the model number when ordering.

SIX COLLECTION

Cup	30306	90
Cup holder	30307	95

LOUNGE SEATING

Spirit Designer - Brian Kane

— CDN Only —

Model Number	Seat H"	Arm H"	W"	D"	H"	Fabric Yds.	Leather Sq.Ft.	COM	COL	Verde	Grano	Cremoso	Knoll Textiles			
													1	2	3	4

LOUNGE CHAIR

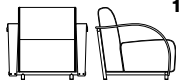
	16110	17½	23½	33½	33	30	3	40	6,205	6,505	7,700	8,100	8,255	6,610	7,030	7,480	7,925
---	--------------	-----	-----	-----	----	----	---	----	-------	-------	-------	-------	-------	-------	-------	-------	-------

TWO SEAT SOFA

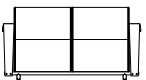
	16120	17½	23½	57½	33	30	6	80	9,385	9,865	12,200	12,940	13,220	10,210	11,040	11,940	12,835
---	--------------	-----	-----	-----	----	----	---	----	-------	-------	--------	--------	--------	--------	--------	--------	--------

THREE SEAT SOFA

	16130	17½	23½	81½	33	30	9	120	12,780	13,415	16,905	17,995	18,430	14,025	15,260	16,615	17,950
---	--------------	-----	-----	-----	----	----	---	-----	--------	--------	--------	--------	--------	--------	--------	--------	--------

OTTOMAN

	16150			24	22	17½	1½	28	3,145	3,295	4,575	4,955	5,095	3,380	3,610	3,855	4,105
---	--------------	--	--	----	----	-----	----	----	-------	-------	-------	-------	-------	-------	-------	-------	-------

Spirit series passes CAL 133 certified for an upcharge of \$440 list per chair, \$870 list per two seater sofa, and \$1305 list per three seat sofa and \$380 list per ottoman. Certification applies to Nienkämper leathers and fabrics that have a minimum of 50% natural fibre content. COM's and COL's are subject to approval. Add the extension -CAL to the model number when ordering.

Model #16110



Model #16110



Model #16120







Model #16150



Select one of the following finishes for the tubular steel frame: Brushed stainless steel, matte black or gloss black. Laminated maple armrests, with black veneer detail, are available in standard Nienkämper veneers and stains, or ebonized, see page 12 for a complete listing. Optional veneers are not offered.

LOUNGE SEATING

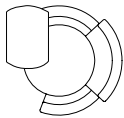
Turnaround® Designer - Nienkämper

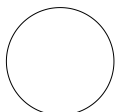





													— CDN Only —									
													KnollTextiles									
Model Number	Seat H"	Arm H"	W"	D"	H"	Fabric Yds.	Leather Sq.Ft.	COM	COL	Verde	Grano	Cremoso	1	2	3	4						
LOUNGE CHAIR WITHOUT ARMS																						
	15401	18¾	25	32	32¼	2½	41						2,415	2,555	3,625	4,040	4,160	2,770	3,110	3,490	3,855	
LOUNGE CHAIR WITH ARMS																						
	15402	18¾	25¼	36	32	32¼	3½	50					3,580	3,765	5,050	5,535	5,705	4,060	4,545	5,070	5,595	
LOUNGE CHAIR WITH TABLET ARMS																						
	15405	18¾	25¼	36	32	32¼	3	50					5,195	5,445	6,740	7,140	7,320	5,605	6,020	6,470	6,915	
OTTOMAN																						
	15403	17½		21½	21½		1¾	30					1,175	1,230	2,110	2,340	2,445	1,405	1,630	1,875	2,130	
OPTIONAL OTTOMAN TOP ACCESSORY																						
	15404			22½	22½	1¾		8						790	825							

Turnaround

- Hardwood/Plywood frame, polyurethane foam and fortrell.
- The back rest on the Armless chair can swivel 360 degrees around the seat with also turns.
- The back swivels independent of the seat and base.
- The Armchair turns (swivels) on its base.
- The round ottoman turns (swivels) and has an optional leather tray that acts as a cocktail table.
- Tablet Arm is made of marine-grade plastic.

LOUNGE SEATING

Tuxedo™ Designer - Nienkämper

Model Number	Seat H"	Arm H"	W"	D"	H"	Fabric Yds.	Leather Sq.Ft.	— CDN Only — Knoll Textiles														
								COM	COL	Verde	Grano	Cremoso	1	2	3	4						
ARMLESS LOUNGE																						
	765	18		25¾	35¾	29	4	65	4,045	4,245	6,945	7,730	8,030	4,595	5,145	5,750	6,345					
LOUNGE																						
 	765-1	18	24¾	31¾	35¾	29	7½	92	5,250	5,525	9,440	10,550	11,000	6,285	7,315	8,450	9,565					
TWO SEAT SOFA																						
	765-2	18	24¾	57½	35¾	29	11½	132	7,690	8,070	14,290	16,015	16,710	9,275	10,855	12,590	14,300					
THREE SEAT SOFA																						
	765-3	18	24¾	83¾	35¾	29	16	172	10,205	10,705	19,100	21,460	22,385	12,410	14,610	17,020	19,400					
FOUR SEAT SOFA																						
	765-4	18	24¾	109	35¾	29	20½	212	12,370	12,985	23,610	26,555	27,745	15,190	18,010	21,100	24,145					

Tuxedo passes CAL 133 certified for an upcharge of \$440 list per chair for armless and arm chair, \$870 list per 2 seat sofa, \$1,305 list per 3 seat sofa and \$1,755 list per 4 seat sofa. Certification applies to Nienkämper leathers and fabrics that have a minimum of 50% natural fibre content. COM's and COL's are subject to approval. Add the extension -CAL to the model number when ordering.

This Tuxedo sofa is offered without a welting detail. The armless lounge chair has finished sides.

When upholstered in leather or COM, seat and back cushions are a foam core with a Dacron wrap. Seat and back cushions are loose.

The base is a recessed ebonized runner.

LOUNGE SEATING

Tuxedo™ Designer - Nienkämper

— CDN Only —

Model Number	Seat H"	Arm H"	W"	D"	H"	Fabric Yds.	Leather Sq.Ft.	COM	COL	Verde	Grano	Cremoso	Knoll Textiles			
													1	2	3	4

SIX SEAT L-SHAPED SOFA

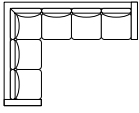

765-6	18	24¾	116	90¼	29	32	322	21,420	22,495	38,245	42,655	44,410	25,820	30,210	35,045	39,815
--------------	----	-----	-----	-----	----	----	-----	--------	--------	--------	--------	--------	--------	--------	--------	--------

SEVEN SEAT L-SHAPED SOFA

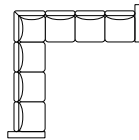

765-7	18	24¾	116	116	29	36	362	23,970	25,185	43,105	48,130	50,140	28,920	33,865	39,300	44,655
--------------	----	-----	-----	-----	----	----	-----	--------	--------	--------	--------	--------	--------	--------	--------	--------

EIGHT SEAT L-SHAPED SOFA

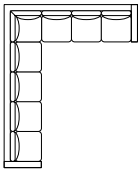

765-8	18	24¾	116	141¾	29	40	402	27,330	28,695	48,765	54,415	56,670	32,825	38,320	44,365	50,315
--------------	----	-----	-----	------	----	----	-----	--------	--------	--------	--------	--------	--------	--------	--------	--------

OTTOMAN



765-5			25¾	25¾	17¾	2½	42	2,205	2,330	4,270	4,810	5,040	2,560	2,900	3,280	3,650
--------------	--	--	-----	-----	-----	----	----	-------	-------	-------	-------	-------	-------	-------	-------	-------

This Tuxedo sofa is offered without a welting detail.





When upholstered in leather or COM, seat and back cushions are a foam core with a Dacron wrap. Seat and back cushions are loose.

The base is a recessed ebonized runner.

LOUNGE SEATING

Tuxedo Classic™ Low Arm Designer - Nienkämper

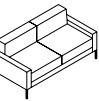
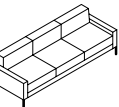
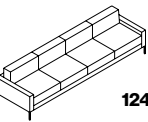
— CDN Only —

Model Number	Seat Arm		W"	D"	H"	Fabric Yds.	Leather Sq.Ft.	COM	COL	Neather	Verde	Grano	Cremoso	Knoll Textiles			
	H"	H"												1	2	3	4
LOUNGE CHAIR ON LEGS																	
 12431	17	21¾	30½	30½	29¾	4½	72	3,815	4,345	4,005	6,505	7,210	7,515	4,320	4,935	5,615	6,285
LOUNGE CHAIR - SWIVEL BASE																	
 12443	17	21¾	30½	30½	29¾	5½	72	3,660	3,825	4,130	6,225	6,915	7,165	4,425	5,175	6,005	6,815
TWO SEAT SOFA																	
 12432	17	21¾	55	30½	29¾	6	96	5,560	5,825	6,225	9,150	10,095	10,470	6,385	7,215	8,115	9,010
THREE SEAT SOFA																	
 12433	17	21¾	79½	30½	29¾	7½	120	7,310	7,655	8,130	11,790	12,970	13,435	8,345	9,370	10,510	11,620
FOUR SEAT SOFA																	
 12434	17	21¾	104	30½	29¾	9	150	8,885	9,330	9,890	14,505	15,975	16,575	10,125	11,360	12,725	14,060
OTTOMAN																	
 12425	17		25	25	17	2¾	24	1,755	1,850	2,055	2,670	2,900	3,005	2,140	2,515	2,930	3,340

Tuxedo Classic with legs passes CAL 133 certified for an upcharge of \$440 list per chair, \$870 list per two seat sofa, \$1305 list per three seat sofa, \$1735 list per four seat sofa, and \$360 list per ottoman. Certification applies to Nienkämper leathers and fabrics that have a minimum of 50% natural fibre content. COM's and COL's are subject to approval. Add the extension -CAL to the model number when ordering.

Model #12431
Lounge chair fully upholstered in leather



Tuxedo Classic is offered without a welting detail. Seat and back cushions have a foam core with Dacron wrap. Back cushions are attached to the frame. Seat cushions are loose.





Square tubular legs made of aluminum are available in a brushed finish. A polished finish is available for an upcharge of \$130 per chair or sofa.

The swivel disk base is upholstered to match the frame.

LOUNGE SEATING

Tuxedo Classic™ Low Arm with Tufting Designer - Nienkämper

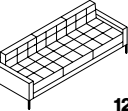
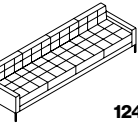
— CDN Only —

Model Number	Seat H"	Arm H"	W"	D"	H"	Fabric Yds.	Leather Sq.Ft.	COM	COL	Neather	Verde	Grano	Cremoso	Knoll Textiles			
														1	2	3	4
LOUNGE CHAIR ON LEGS																	
 12436	17	21¾	30½	30½	29¾	4½	72	4,045	4,245	4,540	6,740	7,440	7,730	4,665	5,280	5,965	6,640
LOUNGE CHAIR - SWIVEL BASE																	
 12444	17	21¾	30½	30½	29¾	5½	72	3,875	4,055	4,345	6,460	7,125	7,380	4,635	5,390	6,220	7,035
TWO SEAT SOFA																	
 12437	17	21¾	55	30½	29¾	6	96	5,955	6,260	6,640	9,550	10,495	10,880	6,785	7,610	8,515	9,410
THREE SEAT SOFA																	
 12438	17	21¾	79½	30½	29¾	7½	120	7,870	8,265	8,725	12,370	13,545	14,025	8,905	9,935	11,070	12,180
FOUR SEAT SOFA																	
 12439	17	21¾	104	30½	29¾	9	150	9,640	10,120	10,650	15,260	16,730	17,325	10,880	12,115	13,480	14,820
OTTOMAN																	
 12430	17		25	25	17	2¾	24	1,920	2,015	2,205	2,805	3,045	3,145	2,295	2,680	3,090	3,500

Tuxedo Classic with legs passes CAL 133 certified for an upcharge of \$440 list per chair, \$870 list per two seat sofa, \$1305 list per three seat sofa, \$1735 list per four seat sofa, and \$380 list per ottoman. Certification applies to Nienkämper leathers and fabrics that have a minimum of 50% natural fibre content. COM's and COL's are subject to approval. Add the extension -CAL to the model number when ordering.





Tuxedo Classic with tufting is offered with a welting detail on seat and back cushions. Seat and back cushions have a foam core with Dacron wrap. Back cushions are attached to the frame. Seat cushions are loose.

Square tubular legs made of aluminum are available in a brushed finish. A polished finish is available for an upcharge of \$130 per chair or sofa.

The swivel disk base is upholstered to match the frame.

LOUNGE SEATING

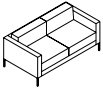
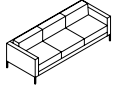
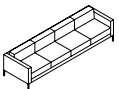
Tuxedo Classic™ High Arm Designer - Nienkämper

Model Number	Seat H"	Arm H"	W"	D"	H"	Fabric Yds.	Leather Sq. Ft.	COM	COL	Neather	Verde	Grano	Cremoso	— CDN Only — Knoll Textiles			
														1	2	3	4
LOUNGE CHAIR ON LEGS																	
 12421	17	28	30½	30½	29¾	4½	72	3,905	4,105	4,410	6,600	7,325	7,595	4,515	5,140	5,820	6,490
LOUNGE CHAIR - SWIVEL BASE																	
 12441	17	28	30½	30½	29¾	4½	72	3,735	3,930	4,230	6,330	6,995	7,295	4,355	4,980	5,655	6,330
TWO SEAT SOFA																	
 12422	17	28	55	30½	29¾	6	96	5,655	5,935	6,325	9,320	10,185	10,490	6,485	7,310	8,215	9,110
THREE SEAT SOFA																	
 12423	17	28	79½	30½	29¾	7½	120	7,400	7,770	8,240	11,885	13,080	13,540	8,430	9,450	10,585	11,705
FOUR SEAT SOFA																	
 12424	17	28	104	30½	29¾	9	150	8,985	9,430	9,995	14,595	16,080	16,670	10,220	11,460	12,820	14,155
OTTOMAN																	
 12425	17		25	25	17	2¾	24	1,755	1,850	2,055	2,670	2,900	3,005	2,140	2,515	2,930	3,340

Tuxedo Classic passes CAL 133 certified for an upcharge of \$440 list per chair, \$870 list per two seat sofa, \$1305 list per three seat sofa, \$1735 list per four seat sofa, and \$380 list per ottoman. Certification applies to Nienkämper leathers and fabrics that have a minimum of 50% natural fibre content. COM's and COL's are subject to approval. Add the extension -CAL to the model number when ordering.

Model #12421
Lounge chair fully upholstered in leather









Tuxedo Classic is offered without a welting detail. Seat and back cushions have a foam core with Dacron wrap. Back cushions are attached to the frame. Seat cushions are loose.

Square tubular legs made of aluminum are available in a brushed finish. A polished finish is available for an upcharge of \$130 per chair or sofa.

The swivel disk base is upholstered to match the frame.

LOUNGE SEATING

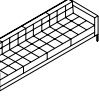
Tuxedo Classic™ High Arm with Tufting Designer - Nienkämper

Model Number	Seat H"	Arm H"	W"	D"	H"	Fabric Yds.	Leather Sq.Ft.	COM	COL	Neather	Verde	Grano	Cremoso	— CDN Only — Knoll Textiles			
														1	2	3	4
LOUNGE CHAIR ON LEGS																	
 12426	17	28	30½	30½	29¾	4½	72	4,140	4,345	4,645	6,860	7,550	7,820	4,765	5,380	6,055	6,730
LOUNGE CHAIR - SWIVEL BASE																	
 12442	17	28	30½	30½	29¾	5½	72	4,035	4,155	4,445	6,540	7,210	7,500	4,795	5,550	6,375	7,195
TWO SEAT SOFA																	
 12427	17	28	55	30½	29¾	6	96	6,065	6,365	6,720	9,645	10,600	10,980	6,895	7,715	8,625	9,520
THREE SEAT SOFA																	
 12428	17	28	79½	30½	29¾	7½	120	7,980	8,365	8,810	12,470	13,640	14,135	9,010	10,045	11,180	12,285
FOUR SEAT SOFA																	
 12429	17	28	104	30½	29¾	9	150	9,740	10,215	10,750	15,355	16,830	17,420	10,975	12,215	13,575	14,910
OTTOMAN																	
 12430	17		25	25	17	2¾	24	1,920	2,015	2,205	2,805	3,045	3,145	3,150	4,390	5,750	7,090

Tuxedo Classic passes CAL 133 certified for an upcharge of \$435 list per chair, \$870 list per two seat sofa, \$1305 list per three seat sofa, \$1735 list per four seat sofa, and \$360 list per ottoman. Certification applies to Nienkämper leathers and fabrics that have a minimum of 50% natural fibre content. COM's and COL's are subject to approval. Add the extension -CAL to the model number when ordering.

Tuxedo Classic with tufting is offered with a welting detail on seat and back cushions. Seat and back cushions have a foam core with Dacron wrap. Back cushions are attached to the frame. Seat cushions are loose.

Square tubular legs made of aluminum are available in a brushed finish. A polished finish is available for an upcharge of \$140 per chair or sofa.

The swivel disk base is upholstered to match the frame.

**Model #12426
Lounge chair**



**Model #12427
Two seat sofa**



**Model #12427
Two seat sofa**



**Model #12428
Three seat sofa**



LOUNGE SEATING

Tuxedo™ Cove Designer - Nienkämper

— CDN Only —

Model Number	Seat Arm		D"	H"	Fabric Yds.	Leather Sq.Ft.	COM	COL	Verde	Grano	Cremoso	Knoll Textiles			
	H"	W"										1	2	3	4

TUXEDO™ COVE THREE SEAT SOFA LEFT

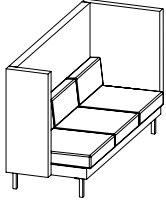

12449	17	46	79¼	31	46	12	216									
COM Frame						8¼	149									
COM Seat & Back Cushion						4½	81									

10,050	10,550	15,090	16,840	17,440	11,700	13,345	15,160	16,945
--------	--------	--------	--------	--------	--------	--------	--------	--------

TUXEDO™ COVE THREE SEAT SOFA RIGHT

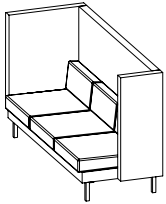

12450	17	46	79¼	31	46	12	216									
COM Frame						8¼	149									
COM Seat & Back Cushion						4½	81									

10,050	10,550	15,090	16,840	17,440	11,700	13,345	15,160	16,945
--------	--------	--------	--------	--------	--------	--------	--------	--------

INTERCONNECTING PANEL

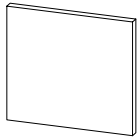

12451		44	3	38¾	2¾	50										
--------------	--	----	---	-----	----	----	--	--	--	--	--	--	--	--	--	--

2,345	2,465	3,845	4,115	4,245	2,720	3,105	3,515	3,925
-------	-------	-------	-------	-------	-------	-------	-------	-------

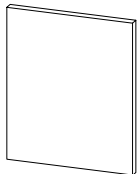

12452		44	3	46	3½	63										
--------------	--	----	---	----	----	----	--	--	--	--	--	--	--	--	--	--

2,835	2,980	4,725	5,055	5,225	3,325	3,810	4,335	4,855
-------	-------	-------	-------	-------	-------	-------	-------	-------

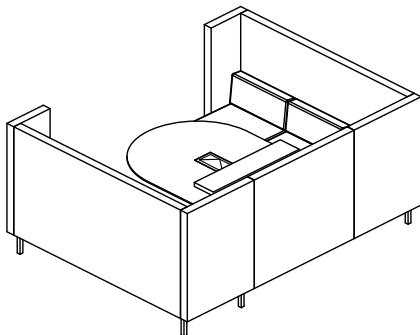

Tuxedo™ Cove Sofa with interconnecting panel
Model # 12451

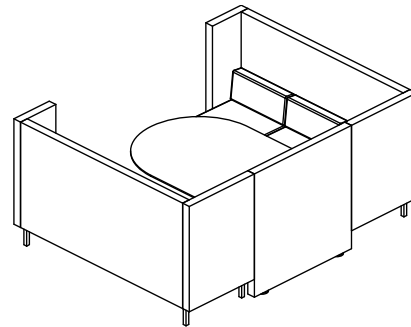

Tuxedo™ Cove Sofa with interconnecting panel
Model # 12452
panel with integrated cavity for wire management

LOUNGE SEATING

Tuxedo™ Cove & Gateway™ Media Lift/Wall Mounted Table Designer - Nienkämper & busk + hertzog

Tuxedo™ Cove is composed of two 3 seat high back sofas with an interconnecting panel and table to form an enclosed booth for meetings, collaborative tasks or to be used as a touchdown base for the day. The high sides and back provide total seclusion from the surrounding environment without the need for interior substructures while additional privacy is maintained via the acoustic benefits of the interconnecting panel and the sofas high walls.

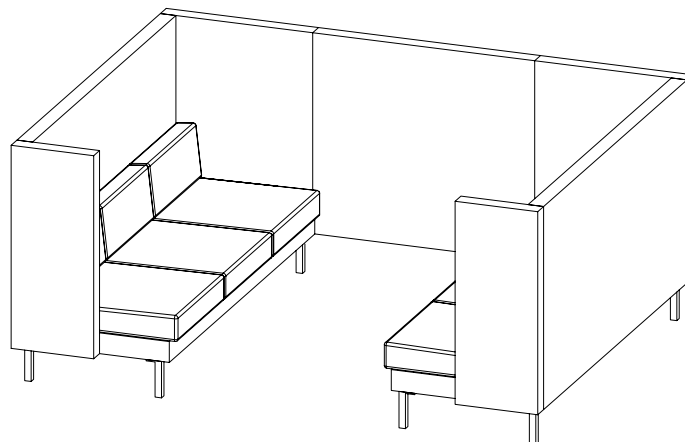

LOUNGE SEATING

Tuxedo™ Cove & Gateway™ Media Lift Table Designer - Nienkämper & busk + hertzog

Table options for Tuxedo™ Cove include the Gateway™ tables, with a full range of connectivity. The Gateway™ Media Lift Table with Relaxed Work Height (26" H) provides a free standing solution while the Gateway™ Wall Mounted Table with Relaxed Work Height (26" H) offers another option for television screen and monitor to be mounted on the interconnecting panel.

Gateway™ Media Lift Table effortlessly transforms meeting tables to create innovative multimedia solutions for communication, presentations and interactive work spaces. At the touch of the remote control, the unit raises the monitor screen up from the base cabinet. The ultimate in professional appearance, Gateway™ Media Lift combines sophistication and function to create additional space, protect your TV from damage or to hide it away from sight.

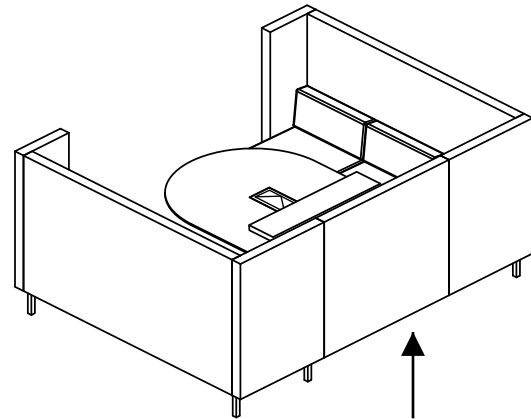

interconnecting panel: 39" h
Model # 12451

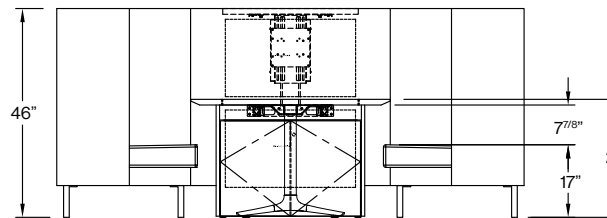
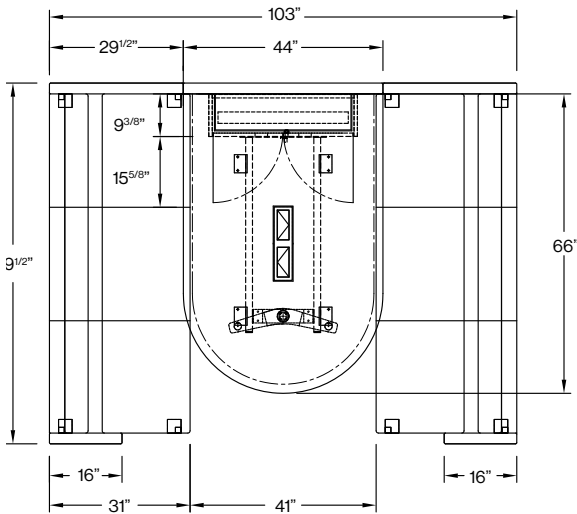

Model #	Description	Quantity	List Price
12449	Tuxedo™ Cove Three Seat Sofa Left in COM	1	10,050
12450	Tuxedo™ Cove Three Seat Sofa Right in COM	1	10,050
12451	Interconnecting Panel (39" H) in COM	1	2,345
43031/5	Gateway Media Lift Table – Relaxed Work Height 26" H in Standard P-lam	1	12,880
85213	Simple Side by Side Pop Up Forum Each side with two power & two open ports	1	1,325
Total List:			36,630

Note:

- Gateway™ Media Lift Table Dimension 66" L x 44" D x 26" H.
- For standard veneer finish, model #43031/2, list price is \$14,040
- TV lift can accommodate a maximum TV size of 32".
- TV lift is included. TV is not included.

LOUNGE SEATING

Tuxedo™ Cove & Gateway™ Wall Mounted Table Designer - Nienkämper & busk + hertzog

Gateway™ Wall Mounted Table provides a simple solution by mounting a TV or monitor screen directly onto the interconnecting panel. The wall mounted Gateway™ table with single base provides maximum knee space for users.

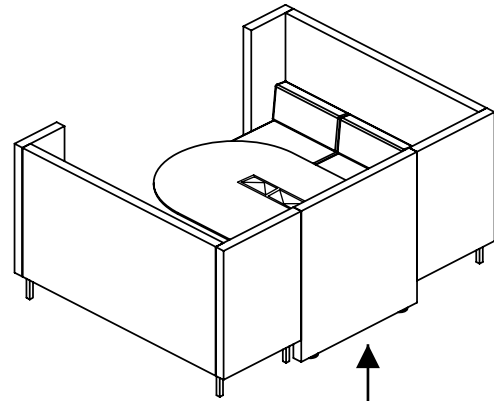

interconnecting panel: 46" h
Model # 12452

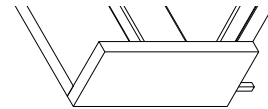
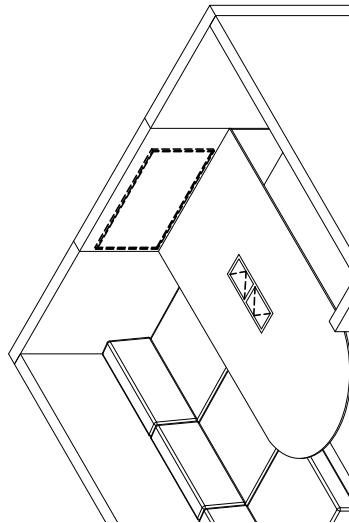

6"

Model #	Description	Quantity	List Price
12449	Tuxedo™ Cove Three Seat Sofa Left in COM	1	10,050
12450	Tuxedo™ Cove Three Seat Sofa Right in COM	1	10,050
12452	Interconnecting Panel (46" H) in COM	1	2,835
43041/5	Gateway Wall Mounted Table – Relaxed Work Height 26" H in Standard P-lam	1	6,640
85213	Simple Forum Side by Side Each side with two power & two open ports	1	1,325
Total List:			30,885

Note:

- Gateway Wall Mounted Table Dimension 66" L x 44" D x 26" H.
- For standard veneer finish, model # 43041/2, list price is \$7,795
- Maximum TV size to be mounted on panel is 32".
- TV & TV mount are not included.

LOUNGE SEATING

Tuxedo™ High Back Designer - Nienkämper

— CDN Only —

Model Number	Seat H"	Arm H"	W"	D"	H"	Fabric Yds.	Leather Sq.Ft.	COM	COL	Verde	Grano	Cremoso	Knoll Textiles			
													1	2	3	4

TWO SEAT SOFA



12445	17	46	55	31	46	9¼	167									
COM Frame						6¾	112									
COM Seat & Back Cushion						3	54									

7,910	8,305	12,320	13,780	14,265	9,185	10,455	11,850	13,225
-------	-------	--------	--------	--------	-------	--------	--------	--------

LARGE TWO SEAT SOFA

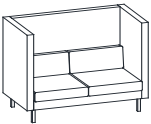

12447	17	46	64	31	46	11¼	203									
COM Frame						7½	135									
COM Seat & Back Cushion						3¾	68									

9,200	9,645	14,330	16,030	16,605	10,750	12,295	13,990	15,670
-------	-------	--------	--------	--------	--------	--------	--------	--------

THREE SEAT SOFA

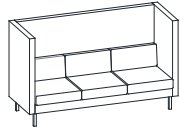

12446	17	46	79½	31	46	12½	225									
COM Frame						8¾	157									
COM Seat & Back Cushion						4½	81									

10,575	11,105	15,955	17,755	18,350	12,300	14,020	15,905	17,765
--------	--------	--------	--------	--------	--------	--------	--------	--------

Tuxedo™ High Back passes CAL 133 certified for an upcharge of \$870 list per two seat sofa and \$1305 list per three seat sofa. Certification applies to Nienkämper leathers and fabrics that have a minimum of 50% natural fibre content. COM's and COL's are subject to approval. Add the extension -CAL to the model number when ordering.

Model # 12446
Tuxedo High Back 3 Seat Sofa



LOUNGE SEATING

Tuxedo™ High Back Designer - Nienkämper

— CDN Only —

Model Number	Seat Arm			D"	H"	Fabric Yds.	Leather Sq.Ft.	COM	COL	Verde	Grano	Cremoso	Knoll Textiles			
	H"	H"	W"										1	2	3	4

HIGH BACK LOUNGE CHAIR



12448	17	46	37¼	31	46	8	144								
COM Frame						6½	117								
COM Seat & Back Cushion						2	36								

5,935	6,925	9,915	10,485	10,765	7,035	8,135	9,340	10,535
-------	-------	-------	--------	--------	-------	-------	-------	--------

ACCESSORIES

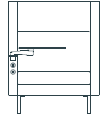

Lounge chair with tablet & power

ARM SIDE CUSHION

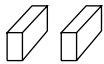

12460		19	3	7	¾	14									
--------------	--	----	---	---	---	----	--	--	--	--	--	--	--	--	--

855	900	1,285	1,360	1,400	965	1,065	1,180	1,285
-----	-----	-------	-------	-------	-----	-------	-------	-------

Note: Dimension is for one piece. List price & yardage is for a set of two pieces

TABLET

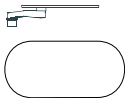

12461	20	12	½												
--------------	----	----	---	--	--	--	--	--	--	--	--	--	--	--	--

1,505

Features

Cushion: Seat and back cushions have a foam core with Dacron wrap. Back cushions are attached to the frame. Seat cushions are loose.

Legs: Square tubular legs made of cast aluminum are available in a brushed finish. A polished finish is available for an upcharge of \$140 list per chair or sofa.

Tablet: Fingerprint resistance solid plastic laminate top in ½" thick, colour available in pure white or black, with silver or white powder coat arm support

Power: Standard with satin nickel frame, white receptacles and 72" cords.

Vox Simple Dot Forums with Trim



Satin nickel trim with white receptacle, model #11864NW \$285 List



Satin nickel trim with white stacked USB, model #11865NW \$490 list



Satin nickel trim with black receptacle, model #11864NB \$285 list



Satin nickel trim with black stacked USB, model #11865NB \$490 list

Vox Simple Dot Forums



White receptacle, model #11867/W \$??? List



White stacked USB, model #11868/W \$??? list



Black receptacle, model #11967/B \$??? List



Black stacked USB, model #11868/B \$??? list



2 Port, power & USB charger white, model #11866W \$850 list



2 Port, power & USB charger black, model #11866/B \$850 list

Model # 12448
Tuxedo High Back Lounge Chair upholstered in Verde leather / Graphite VE 6008 with arm side cushion, tablet & power

Model # 12448



LOUNGE SEATING

Vuelo Lounge Designer - johnson chou

— CDN Only —

Model Number	Seat H"	Arm H"	W"	D"	H"	Fabric Yds.	Leather Sq.Ft.	COM	COL	Neather	Verde	Grano	Cremoso	KNOLL TEXTILES			
														1	2	3	4

VUELO LOUNGE CHAIR HIGH BACK



Model	Seat H"	Arm H"	W"	D"	H"	Fabric Yds.	Leather Sq.Ft.	COM	COL	Neather	Verde	Grano	Cremoso	1	2	3	4
10073	15	20	29	30	41	3	54	4,020	4,225	4,320	5,695	5,985	6,125	4,435	4,845	5,290	5,745
10073/1						2		4,020		4,320				4,290	4,570	4,870	5,170
							1										
10073/2						36			4,225		5,695	5,985	6,125				
							18										
10073/3						2		4,710						4,995	5,265	5,565	5,865
							18										

VUELO OTTOMAN

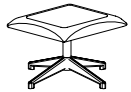

Model	Seat H"	Arm H"	W"	D"	H"	Fabric Yds.	Leather Sq.Ft.	COM	COL	Neather	Verde	Grano	Cremoso	1	2	3	4
10074	15	20	29	29	15	1	18	1,355	1,425	1,455	1,915	2,015	2,055	1,495	1,630	1,780	1,935

Standard features:



- Moulded plywood seat and arm shell
- Soy based flexible polyurethane foam
- Polished aluminum 4-star base on glides
- For model /3 with fabric seat & back and verde leather arms & bottom, welding detail on the back in same Verde leather is standard

Model # 10073 & 10074

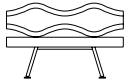

LOUNGE SEATING

Wavelength® Designer - karim rashid

											— CDN Only —								
Model Number	Seat H"	W"	D"	H"	Fabric		COM	COL	Verde	Grano	Cremoso	Knoll Textiles							
					Yds.	Sq.Ft.						1	2	3	4				
CHAIR																			
	1401_	16¾	23¾	31	30¾														
	(Model #1)	Fully upholstered				1½	24	3,620	3,805	4,515	4,765	4,865	3,830	4,035	4,260	4,480			
	(Model #2)	Fabric seat & back, fabric contrasting trim				¾	¾	3,620					3,725	3,830	3,940	4,050			
(Model #3)	Leather seat & back, leather contrasting trim				12	12		3,805	4,515	4,765	4,865								
TWO SEAT SOFA																			
	1402_	16¾	47¼	31	30¾														
	(Model #1)	Fully upholstered				3	48	4,280	4,500	6,090	6,550	6,745	4,695	5,110	5,560	6,010			
	(Model #2)	Fabric seat & back, fabric contrasting trim				1½	1½	4,280					4,490	4,695	4,920	5,145			
(Model #3)	Leather seat & back, leather contrasting trim				24	24		4,500	6,090	6,550	6,745								
THREE SEAT SOFA																			
	1403_	16¾	70¾	31	33														
	(Model #1)	Fully upholstered				4½	72	4,965	5,205	7,655	8,365	8,655	5,585	6,205	6,885	7,550			
	(Model #2)	Fabric seat & back, fabric contrasting trim				2¼	2¼	4,965					5,275	5,585	5,925	6,260			
(Model #3)	Leather seat & back, leather contrasting trim				36	36		5,205	7,655	8,365	8,655								

Wavelength passes CAL 133 certified for an upcharge of \$435 list per chair, \$870 list per 2 seat sofa and \$1,305 list per 3 seat sofa. Certification applies to Nienkämper leathers and fabrics that have a minimum of 50% natural fibre content. COM's and COL's are subject to approval. Add the extension -CAL to the model number when ordering.

Fabric direction when railroaded

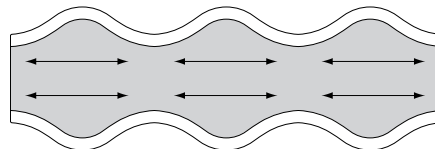

Fabric yardages are based on plain fabrics with no apparent pattern direction. Fabric is railroaded.

When upholstering in two different fabrics or leathers use the COM price or COL price and ship yardages or square footage as noted on page 6. Most fabrics and vinyl are suitable for the top seat portion but the contrasting trim must have stretch.

Nienkämper reserves the right to determine the suitability of COM on our furniture. For further details regarding approvals, refer to page 6.

Specify polished or brushed aluminum frame

Model #14012
Contrasting trim,
polished aluminum frame

Model #14032
Contrasting trim,
polished aluminum frame

Model #14031
Fully upholstered,
polished aluminum frame

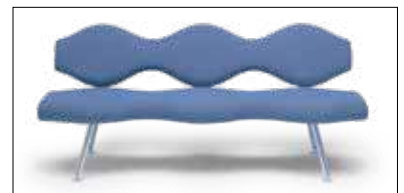



Fabric to be upholstered on Wavelength requires approval from Nienkämper's factory. Please contact customer service at 800 668 9318 for our fabric approval list.

LOUNGE SEATING

Wavelength® Designer - karim rashid

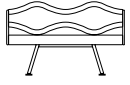
— CDN Only —

Model Number	Seat H"	W"	D"	H"	Fabric Leather		COM	COL	Verde	Grano	Cremoso	Knoll Textiles						
					Yds.	Sq.Ft.						1	2	3	4			
CHAIR WITH ARM																		
	1401_	16 3/4"	23 5/8"	31"	30 3/4"													
	(Model #7)	Fully Upholstered				1 1/2	24	5,430	5,710	6,330	6,565	6,680	5,640	5,840	6,075	6,295		
	(Model #8)	Fabric seat & back, fabric contrasting trim				3/4	3/4	5,445					5,555	5,655	5,770	5,880		
(Model #9)	Leather seat & back, leather contrasting trim				12	12		5710	6330	6565	6680							
TWO SEAT SOFA WITH ARM																		
	1402_	16 3/4"	47 1/4"	31"	30 3/4"													
	(Model #7)	Fully Upholstered				3	48	6,105	6,395	7,895	8,355	8,560	6,520	6,925	7,375	7,825		
	(Model #8)	Fabric seat & back, fabric contrasting trim				1 1/2	1 1/2	6,105					6,315	6,520	6,745	6,965		
(Model #9)	Leather seat & back, leather contrasting trim				24	24		6,395	7,895	8,355	8,560							
THREE SEAT SOFA WITH ARM																		
	1403_	16 3/4"	70 5/8"	31"	33"													
	(Model #7)	Fully Upholstered				4 1/2	72	6,780	7,125	9,475	10,180	10,470	7,405	8,020	8,695	9,370		
	(Model #8)	Fabric seat & back, fabric contrasting trim				2 1/4	2 1/4	6,780					7,095	7,405	7,740	8,075		
(Model #9)	Leather seat & back, leather contrasting trim				36	36		7,125	9,475	10,180	10,470							

Wavelength passes CAL 133 certified for an upcharge of \$435 list per chair, \$870 list per 2 seat sofa and \$1,305 list per 3 seat sofa. Certification applies to Nienkämper leathers and fabrics that have a minimum of 50% natural fibre content. COM's and COL's are subject to approval. Add the extension -CAL to the model number when ordering.

Fabric yardages are based on plain fabrics with no apparent pattern direction. Fabric is railroaded.

When upholstering in two different fabrics or leathers use the COM price or COL price and ship yardages or square footage as noted on page 6. Most fabrics and vinyl are suitable for the top seat portion but the contrasting trim must have stretch.

Nienkämper reserves the right to determine the suitability of COM on our furniture. For further details regarding approvals, refer to page 6.

Specify polished or brushed aluminum frame

Fabric to be upholstered on Wavelength requires approval from Nienkämper's factory. Please contact customer service at 800 668 9318 for our fabric approval list.

Fabric direction when railroaded

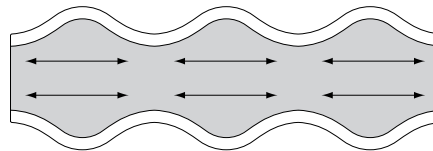

Model #14037
Polished aluminum frame and arms

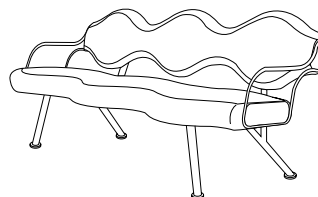

Arms with table on both sides available at an upcharge of \$685 each or \$1370 a pair

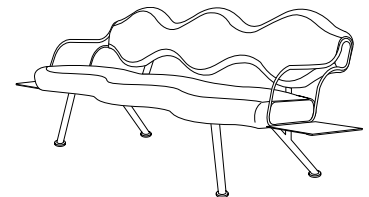

LOUNGE SEATING

Work:Recline Designer - 5D Studio

— CDN Only —
Knoll Textiles

Model Number	Seat H"	Arm H"	W"	D"	H"	Fabric Yds.	Leather Sq.Ft.	COM	COL	Verde	Grano	Cre moso	1	2	3	4
--------------	---------	--------	----	----	----	-------------	----------------	-----	-----	-------	-------	----------	---	---	---	---

WORK:RECLINE CHAIR

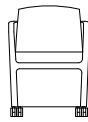
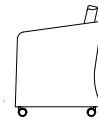
		11000	18	24½	25	26	33	3¾	68	3,695	3,885	5,325	5,685	6,040	4,215	4,720	5,290	5,845
---	---	--------------	----	-----	----	----	----	----	----	-------	-------	-------	-------	-------	-------	-------	-------	-------

Unique feature: reclining back, forward sliding seat pan.

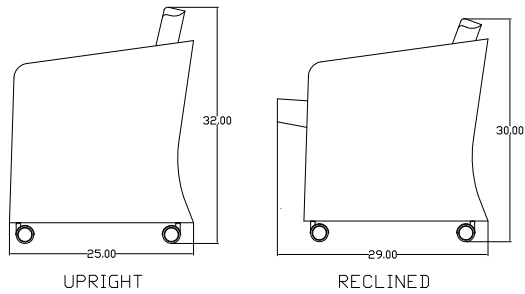

Model #11000



Model #11000



Model #11000



Standard features:

Upholstered in fabric, leather or a combination, the chair is hardwood construction soy based foam cushions. Black casters are standard.

LOUNGE SEATING

Yabaco Designer – Ryann Aoukar & Damien Robache

— CDN Only —

Model Number	Seat Arm			D"	H"	Fabric Yds.	Leather Sq. Ft.	COM	COL	Verde	Grano	Cremoso	Knoll Textiles			
	H"	H"	W"										1	2	3	4

YABACO CHAIR

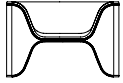

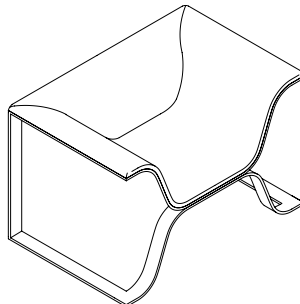
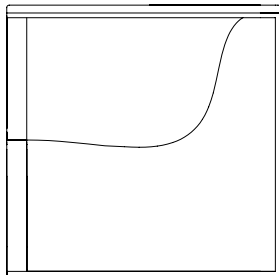

15130	15	27¾	36½	26¾	28	3	54							4,550	4,785	6,215	6,670	6,860	4,965	5,380	5,825	6,275
--------------	----	-----	-----	-----	----	---	----	--	--	--	--	--	--	-------	-------	-------	-------	-------	-------	-------	-------	-------

Solid bar stock steel frame, Brushed Nickel finish
Polished chrome available, upcharge \$760 list

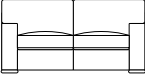
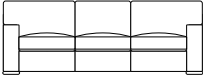

LOUNGE SEATING

Zurich Designer – Nienkämper & robert haussmann

Model Number	Seat H"	Arm H"	W"	D"	H"	Fabric Yds.	Leather Sq.Ft.	COM	COL	Verde	Grano	Cremoso	— CDN Only — Knoll Textiles					
													1	2	3	4		
LOUNGE CHAIR																		
 460	17½	21	33	35	30	6½	95	6,900	7,210	10,445	11,380	11,750	8,015	8,945	9,190	9,570		
TWO SEAT SOFA																		
 460-2	17½	21	56	35	30	8¾	140	9,545	10,015	14,790	16,165	16,720	11,070	12,305	12,645	13,165		
THREE SEAT SOFA																		
 460-3	17½	21	79	35	30	11¾	185	12,470	13,090	19,385	21,220	21,930	14,505	16,170	16,630	17,325		
FOUR SEAT SOFA																		
 460-4	17½	21	102	35	30	14	230	15,515	16,300	24,130	26,400	27,310	17,955	19,940	20,475	21,315		
OTTOMAN																		
 460-5			28	28	17	3	48	3,845	4,045	5,650	6,120	6,300	4,370	4,795	4,900	5,090		

Zurich series passes CAL 133 certified for an upcharge of \$490 list per chair, \$975 list per two seater sofa, \$1460 list per three seat sofa, \$1945 list per four seat sofa, and \$485 list per ottoman. Certification applies to Nienkämper leathers and fabrics that have a minimum of 50% natural fibre content. COM's and COL's are subject to approval. Add the extension -CAL to the model number when ordering.

When COM is lightweight, a welting detail is added to the perimeter of the seat and back cushions. Allow 5% additional yardage of COM to accommodate welting details.

When upholstered in leather, seat and back cushions have a foam core wrapped in a down and feather combination.

When upholstered in COM, seat and back cushions have a foam core wrapped in Dacron.

All seat and back cushions are loose.

Two base options are available. Radius feet, see photo on page 58, are offered ebonized as standard. Angled wood feet, see photo on page 58, are offered ebonized as standard. Both Radius and Angled feet are available in standard Nienkämper stains, see page 12 for a listing. To match custom stains add \$600 list per stain color.

Model #460



Model #460-2



Model #460-3



LOUNGE SEATING

Zurich Designer – Nienkämper & robert haussmann

— CDN Only —

Model Number	Seat H"	Arm H"	W"	D"	H"	Fabric Yds.	Leather Sq.Ft.	COM	COL	Verde	Grano	Cremoso	Knoll Textiles			
													1	2	3	4

SIX SEAT L-SHAPED SOFA

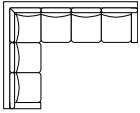

460-6	17½	21	109	86	30	20	320	24,280	25,495	36,255	39,415	40,660	27,755	30,585	31,370	32,535
--------------	-----	----	-----	----	----	----	-----	--------	--------	--------	--------	--------	--------	--------	--------	--------

SEVEN SEAT L-SHAPED SOFA

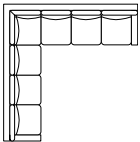

460-7	17½	21	109	109	30	28	365	27,815	29,220	41,490	45,080	46,505	31,810	35,080	35,980	37,340
--------------	-----	----	-----	-----	----	----	-----	--------	--------	--------	--------	--------	--------	--------	--------	--------

EIGHT SEAT L-SHAPED SOFA

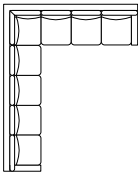

460-8	17½	21	109	109	30	26	410	31,305	32,880	46,665	50,685	52,315	35,825	39,505	40,540	42,070
--------------	-----	----	-----	-----	----	----	-----	--------	--------	--------	--------	--------	--------	--------	--------	--------

Zurich series passes CAL 133 certified for an upcharge of \$2915 list for six seat, \$3400 list for seven seat, and \$3885 list for eight seat. Certification applies to Nienkämper leathers and fabrics that have a minimum of 50% natural fibre content. COM's and COL's are subject to approval. Add the extension -CAL to the model number when ordering.

When COM is lightweight, a welting detail is added to the perimeter of the seat and back cushions. Allow 5% additional yardage of COM to accommodate welting details.

When upholstered in leather, seat and back cushions have a foam core wrapped in a down and feather combination.

When upholstered in COM, seat and back cushions have a foam core wrapped in Dacron.

All seat and back cushions are loose.

Two base options are available. Radius feet, see photo below left, are offered ebonized as standard. Angled wood feet, see photo below right, are offered ebonized as standard. Both Radius and Angled feet are available in standard Nienkämper stains, see page 12 for a listing. To match custom stains add \$600 list per stain color.

Radius Foot



Angled Foot

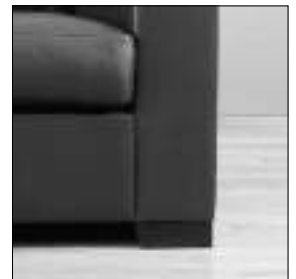

nienkämper

International Inc.

STOOLS AND BENCHES



STOOLS AND BENCHES

TABLE OF CONTENTS

Stools and Benches	155-177
32 Bench	157
Align	158
Blottoman™	159
Caravite	160
Corbu	161
Elevation™ Bench	162
Exhale	163
Hocker Stool	164
Jackal	165
Kloud® Benches	166
Max™ Benches	167
Mint	168
Moment Collection	169
Nienkämper River	170-171
Patkau Bench	172
Pullman™ Benches	173
Six® Collection Benches	174
Spin Stool/Tables	175
Wavelength® Benches	176
Zoo Stools	177

STOOLS AND BENCHES

32 Collection

— CDN Only —

Model Number	Seat H"	W"	D"	H"	Fabric Yds.	Leather Sq.Ft.	COM	COL	Neather	Verde	Grano	Cremoso	Knoll Textiles			
													1	2	3	4

32 BENCH SMALL (4 SQUARES X 9 SQUARES)

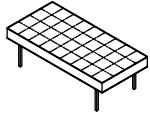

32031 17 54 26 17 2½ 45

2,855 2,995 3,085 4,165 4,390 4,500 3,195 3,540 3,920 4,285

32 BENCH LARGE (4 SQUARES X 14 SQUARES)

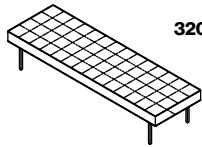

32032 17 84 26 17 4 72

3,565 3,745 3,935 5,615 5,975 6,155 4,120 4,670 5,270 5,865

Standard features:

- Standard with tufting on bench.
- Plywood frame with soy based polyurethane foam.
- Support frame & legs are standard in brushed aluminum finish.
- Powder coat finishes also available upon request.

**Model # 32031
32 Bench Small**



STOOLS AND BENCHES

Align Designer - Nienkämper

— CDN Only —

Model Number	Seat H"	W"	D"	H"	Fabric Yds.	Leather Sq.Ft.	COM	COL	Neather	Verde	Grano	Cremoso	Knoll Textiles			
													1	2	3	4

ALIGN STOOL

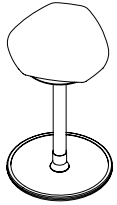

10880	23-32	15	15	23-32	¾	12	1,930	2,030	1,995	2,340	2,395	2,430	2,020	2,115	2,205	2,305
--------------	-------	----	----	-------	---	----	-------	-------	-------	-------	-------	-------	-------	-------	-------	-------

Standard features:

- Comfortable triangular seat with polyurethane foam.
- Seat height is adjustable from seating to standing height (23-32"H) with anti-twist gas spring.
- Base is standard in black with curved foot.



Model # 10880



STOOLS AND BENCHES

Blottoman™ Benches Designer - karim rashid

— CDN Only —

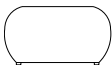
Model Number	Seat H"	W"	D"	H"	Fabric Leather		COM	COL	Verde	Grano	Cremoso	Knoll Textiles				
					Yds.	Sq. Ft.						1	2	3	4	
BLOTTOMAN																
	14902 Fully Upholstered	14	18	18	14	1 1/3	23									
								785	815	1,450	1,635	1,710	970	1,150	1,350	1,545
	14906 Contrasting fabric						1/2							855	920	995
	14907 Contrasting leather						9		815	1,450	1,635	1,710				
BLOTTOMAN SQUARE BENCH																
	14911 Fully Upholstered	17 1/2	24	24	17 1/2	1 1/3	23									
								1,255	1,325	2,120	2,340	2,445	1,445	1,625	1,825	2,025
	14912 Contrasting fabric					3/4								1,350	1,435	1,540
	14913 Contrasting leather						10		1,325	2,120	2,340	2,445				
BLOTTOMAN TWO SEAT BENCH																
	14914 Fully Upholstered	17 1/2	48	24	17 1/2	2 1/3	35									
								2,185	2,295	3,485	3,825	3,960	2,510	2,825	3,180	3,525
	14915 Contrasting fabric					1 1/3								2,415	2,645	2,900
	14916 Contrasting leather						22		2,295	3,485	3,825	3,960				
BLOTTOMAN LARGE SQUARE BENCH																
	14917 Fully Upholstered	17 1/2	34	34	17 1/2	1 1/3	30									
								1,955	2,050	3,080	3,380	3,490	2,185	2,410	2,670	2,910
	14918 Contrasting fabric					1 1/3								2,185	2,410	2,670
	14919 Contrasting leather						16		2,050	3,080	3,380	3,490				

Blottoman passes CAL 133 certified for an upcharge of \$380 list per square bench; two seat bench \$760 list; large square bench \$535 list; blottoman \$285 list. Certification applies to Nienkämper leathers and fabrics that have a minimum of 50% natural fibre content. COM's and COL's are subject to approval. Add the extension "-CAL" to the model number when ordering.

The curvaceous shape and soft molded foam of the Blottoman are conducive to fabrics with some stretch and minimum pattern.

When upholstered in two different fabrics or leathers, use the COM price and ship your fabric yardage or leather square footage to Nienkämper. See page 6 for COM and COL details.

Seams can have matching or contrasting stitching. Matching or contrasting welting detail can also be specified.

*For patterned or directional fabrics please contact Customer Service at 800.668.9318 for yardages.

**Right: Model #14912
Left: Model #14918
Shown with a Virso occasional table,
Model # 32020T1**

Model #14915



STOOLS AND BENCHES

Caravite Designer - busk + hertzog

Model Number	Seat H"	W"	D"	H"	Fabric		COM	COL	Neather	Verde	Grano	Cremoso	— CDN Only — Knoll Textiles			
					Yds.	Sq. Ft.							1	2	3	4

CARAVITE STOOL



10221	31 3/4	18	14	31 3/4	3/4	14	1,040	1,090	1,105	1,450	1,510	1,545	1,150	1,250	1,365	1,470
--------------	--------	----	----	--------	-----	----	-------	-------	-------	-------	-------	-------	-------	-------	-------	-------

CARAVITE BENCH

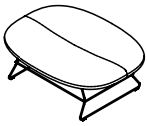

10222	16 1/2	47 3/4	35 3/4	16 1/2	2 1/2	41	1,730	1,820	1,935	2,860	3,060	3,150	2,070	2,410	2,795	3,165
--------------	--------	--------	--------	--------	-------	----	-------	-------	-------	-------	-------	-------	-------	-------	-------	-------

Model # 10222 & 10221
Caravite bench & stool



Standard features:

- Distinctive contoured seat cushion with polyurethane foam and plywood frame
- Top stitch detail is standard and contrasting stitching can also be specified.
- Tubular steel frame standard with black powder coat finish, other powder coat colors are available upon request.

STOOLS AND BENCHES

Corbu Bench & Ottoman Designer - Nienkämper

— CDN Only —

Model Number	Seat H"	W"	D"	Fabric		COM	COL	Verde	Grano	Cremoso	Knoll Textiles			
				Yds.	Sq.Ft.						1	2	3	4

CORBU BENCH

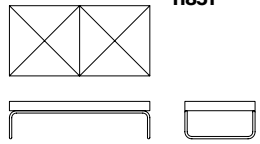
	11851	16	60	30	2%	40	3,525	3,700	4,610	4,980	5,100	3,900	4,260	4,665	5,060
---	--------------	----	----	----	----	----	-------	-------	-------	-------	-------	-------	-------	-------	-------

CORBU OTTOMAN

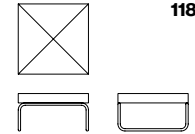
	11852	16	30	30	2%	20	2,310	2,415	2,860	3,040	3,105	2,635	2,955	3,305	3,655
---	--------------	----	----	----	----	----	-------	-------	-------	-------	-------	-------	-------	-------	-------

Model #11851



Model #11852



Standard Features

- Chrome tubular frame
- Button tufted with diamond upholstery pattern
- Cushion has 20% soy foam content

STOOLS AND BENCHES

Elevation™ Benches Designer - Johnson Chou

Model Number	W"	D"	H"	Fabric		COM	COL	Verde	Grano	Cremoso	— CDN Only — Knoll Textiles			
				Yds.	Sq. Ft.						1	2	3	4

ELEVATION™ BENCH SILVER PAINTED BASE

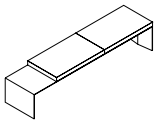
 23801	101	24	16½	3¾	68	8,460	8,885	10,310	10,935	11,125	8,980	9,500	10,065	10,625
--	-----	----	-----	----	----	-------	-------	--------	--------	--------	-------	-------	--------	--------

ELEVATION BENCH STAINLESS STEEL BASE

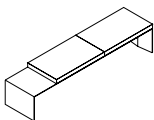
 23806	101	24	16½	3¾	68	10,300	10,815	12,150	12,760	12,970	10,815	11,325	11,895	12,450
--	-----	----	-----	----	----	--------	--------	--------	--------	--------	--------	--------	--------	--------

Elevation Bench passes CAL 133 certified for an upcharge of \$960 list per bench. Certification applies to Nienkämper leathers and fabrics that have a minimum of 50% natural fibre content. COM's and COL's are subject to approval. Add the extension "-CAL" to the model number when ordering.

Elevation Bench

- Cushion is 80" long.
- Price includes a silver painted base as standard.
Upcharges apply for a wood veneer base, contact Customer Service for finish options and pricing.

Model #23801
Elevation bench



STOOLS AND BENCHES

Exhale Designer -busk + hertzog

Model Number	Seat				Fabric Yds.	Leather Sq. Ft.	COM	COL	Neather	Verde	Grano	Cremoso	— CDN Only — KnollTextiles			
	H"	W"	D"	H"									1	2	3	4

EXHALE BENCH

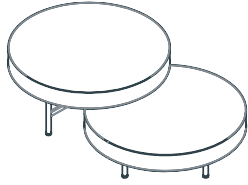

10295	16½ 24	80¼	48¼	16½ 24	6 yds (if same fabric is used for both circles)	108	4,300	4,515	4,810	6,960	7,465	7,710	5,155	6,005	6,930	7,855
10295-1	16½ 24	80¼	48¼	16½ 24	If different fabric is used for each circle; Each circle requires 4 yds	144	4,300	4,515	4,980	7,840	8,515	8,850	5,435	6,565	7,815	9,030

Exhale Bench

- Footprint Dimension: 80¼" x 48¼" x 16½" / 24"H
- Seat Element Dimension: 48¼" dia. x 6"
- Seat Material: all standard KnollTextiles and COM fabrics
- Leg Material: mild steel hollow tube
- Leg Finish: satin black powder coat
- Power Options: Byrne Dubbel, Garcia, Night Cap, Kia

Model # 10295-1

Exhale



STOOLS AND BENCHES

Hocker Office Stool Designer -Nienkämper

— CDN Only —

Model Number	Seat H"	W"	D"	Fabric Yds.	Leather Sq.Ft.	Knoll Textiles											
						COM	COL	Neather	Verde	Grano	Cremoso	1	2	3	4		

HOCKER OFFICE STOOL

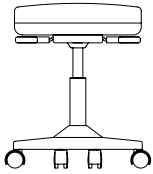

15201	18-21	18	18	$\frac{2}{3}$	12	760	785	825	1,060	1,125	1,200	855	940	1,045	1,140
--------------	-------	----	----	---------------	----	-----	-----	-----	-------	-------	-------	-----	-----	-------	-------

HOCKER OFFICE TALL STOOL

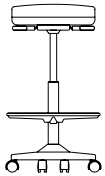

15202	25-35	18	18	$\frac{2}{3}$	12	840	885	910	1,130	1,210	1,280	930	1,025	1,125	1,225
--------------	-------	----	----	---------------	----	-----	-----	-----	-------	-------	-------	-----	-------	-------	-------

Standard features:

- Cushion has 25% soy foam content
- Pneumatic height adjustment
- Base is black
- Tall stool has polished aluminum foot ring

Model # 15201



Model # 15202



STOOLS AND BENCHES

Jackal Stool Designer - Fig40

Model Number	W"	D"	H"	List Price
--------------	----	----	----	------------

JACKAL STOOL



10226	20¾	19½	37 ⅞	1,510
-------	-----	-----	------	-------

Model # 10226
Jackal Stool





Standard Features

- Seat Material: stripy Beech 3D veneer
- Frame Material: stainless steel rod
- Seat Finish: standard stain & finish
- Frame Finish: brushed stainless, powder coat satin black

STOOLS AND BENCHES

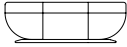
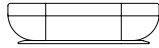
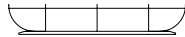



Kloud® Benches Designer - Karim Rashid

Model Number	Seat H"	W"	D"	Fabric		— CDN Only — Knoll Textiles											
				Yds.	Sq. Ft.	COM	COL	Verde	Grano	Cre moso	1	2	3	4			
TWO SEAT BENCH																	
	14998	16	48	30	3	56	2,815	2,955	4,370	5,010	5,195	3,235	3,650	4,095	4,545		
	Fully upholstered																
	14977	Contrasting Fabric			1½		2,815					3,025	3,235	3,460	3,685		
		Top/seat															
		Bottom			1½												
	14978	Contrasting Leather						2,955	4,370	5,010	5,195						
		Top/seat			27												
		Bottom			27												
TWO SEAT LARGE BENCH																	
	14953	16	60	30	3½	62	3,665	3,840	5,375	6,100	6,285	4,145	4,630	5,160	5,680		
	Fully upholstered																
	14951	Contrasting Fabric					3,665					3,910	4,145	4,410	4,675		
		Top/seat			1¾												
		Bottom			2												
	14952	Contrasting Leather						3,840	5,375	6,100	6,285						
		Top/seat			32												
		Bottom			36												
THREE SEAT BENCH																	
	14999	16	72	30	4	72	4,800	5,040	6,790	7,605	7,845	5,350	5,905	6,500	7,100		
	Fully upholstered																
	14979	Contrasting Fabric					4,800					5,075	5,350	5,650	5,950		
		Top/seat			2												
		Bottom			2½												
	14980	Contrasting Leather						5,040	6,790	7,605	7,845						
		Top/seat			36												
		Bottom			42												
OTTOMAN																	
	14990	16	30	30	2½	45	1,935	2,035	3,175	3,695	3,845	2,275	2,615	3,000	3,370		
	Fully upholstered																
	14961	Contrasting Fabric					1,935					2,125	2,300	2,500	2,700		
		Top/seat			1⅓												
		Bottom			1¼												
	14962	Contrasting Leather						2,035	3,175	3,695	3,845						
		Top/seat			24												
		Bottom			23												

Fabric to be upholstered on Kloud requires approval from Nienkamper's factory. Please contact customer service at 800 668 9318 for our fabric approval list.

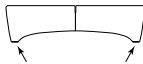
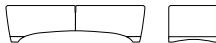
STOOLS AND BENCHES

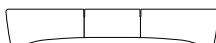
MAX™ Benches Designer - Mark Müller

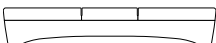
Model Number	Seat H"	W"	D"	H"	Fabric		Leather				— CDN Only — Knoll Textiles				
					Yds.	Sq.Ft.	COM	COL	Verde	Grano	Cremoso	1	2	3	4
TWO SEAT BENCH															
 16420	17	64	25	17	3¾	60	2,940	3,080	5,180	5,765	6,005	3,460	3,970	4,545	5,100
wood level ebonized unless specified															
TWO SEAT BENCH-WOOD RUNNER															
 16421	17	64	25	17	3¾	60	3,780	3,960	6,025	6,615	6,870	4,295	4,815	5,385	5,940
TWO SEAT BENCH-WOOD BASE															
 16422	17	64	25	17	2½	43	5,490	5,785	7,115	7,535	7,700	5,835	6,175	6,560	6,925
THREE SEAT BENCH															
 16430	17	87	25	17	4¾	84	3,895	4,080	7,025	7,855	8,200	4,545	5,200	5,920	6,615
THREE SEAT BENCH-WOOD RUNNER															
 16431	17	87	25	17	4¾	84	4,720	4,965	7,860	8,690	9,030	5,380	6,030	6,755	7,455
THREE SEAT BENCH-WOOD BASE															
 16432	17	87	25	17	3½	60	5,870	6,170	8,120	8,705	8,950	6,355	6,840	7,365	7,890

Max Benches pass CAL 133 certified for an upcharge \$435 list per 2 seat bench, and \$870 list per 3 seat bench. Certification applies to Nienkämper leathers and fabrics that have a minimum of 50% natural fibre content. COM's and COL's are subject to approval. Add the extension "-CAL" to the model number when ordering.

Max Benches

Benches are available fully upholstered (Model # 16420 and #16430), with a solid maple runner (Model # 16421 and # 16431), or with a wood veneer base (Model # 16422 and #16432). Wood runners and bases are available in standard Nienkämper veneers and stains, refer to page 12 for a listing. To match custom stains add \$600 list for each stain colour.

Model #16421



Model #16421



Model #16422



Model #16422



STOOLS AND BENCHES

Mint Designer - busk + hertzog

Model Number	Seat H"	W"	D"	H"	Fabric Yds.	Leather Sq.Ft.	COM	COL	Neather	Verde	Grano	Cremoso	— CDN Only — Knoll Textiles			
													1	2	3	4

MINT STOOL

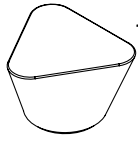

10780	16½	26¼	23¾	16½	2	36	1,700	1,785	1,885	2,720	2,900	2,990	1,975	2,250	2,555	2,855
--------------	-----	-----	-----	-----	---	----	-------	-------	-------	-------	-------	-------	-------	-------	-------	-------

Model # 10780



Standard features:

- Frame is constructed of FSC plywood core
- Stool with molded foam

STOOLS AND BENCHES

Moment collection Designer - busk + hertzog

— CDN Only —

Knoll Textiles

Model Number	W"	H"	Fabric Yds	Leather Sq.Ft.	COM	COL	Verde	Grano	Cre moso	1	2	3	4
--------------	----	----	------------	----------------	-----	-----	-------	-------	----------	---	---	---	---

MOMENT STOOLS

19½" top

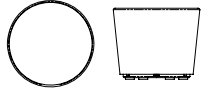

26011	19½ dia.	16	2	36	1,405	1,480	2,385	2,585	2,685	1,680	1,955	2,255	2,560
--------------	----------	----	---	----	-------	-------	-------	-------	-------	-------	-------	-------	-------

16½" top

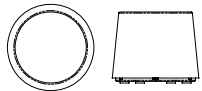

26012	16½ dia.	16	2	36	1,405	1,480	2,385	2,585	2,685	1,680	1,955	2,255	2,560
--------------	----------	----	---	----	-------	-------	-------	-------	-------	-------	-------	-------	-------

MOMENT TABLES

19½" top



26021/2	19½ dia.	16	Veneer	1,820
26021/5			P-Lam	1,200
26021/7			Paint	1,350

16½" top



26022/2	16½ dia.	16	Veneer	1,820
26022/5			P-Lam	1,200
26022/7			Paint	1,350

*List price for tables doesn't include power unit.

SIMPLE POP UP FORUM

(4 power pre-wired with 72" cord)

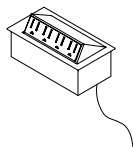

8174	975
-------------	-----

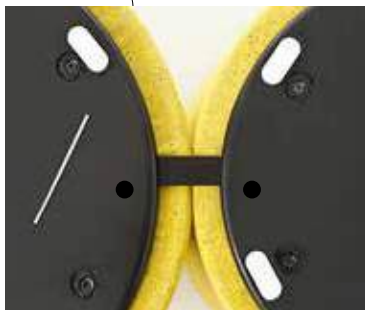

Linking device detail

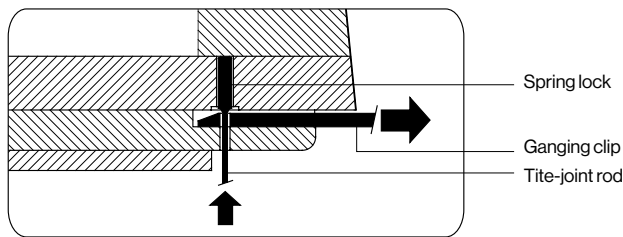

Standard features:

- Frame is constructed of FSC Plywood core
- Stool with molded foam
- The table is available in white, silver, or black paint finish or any standard wood veneer or P-Lam.
- With glides at bottom

STOOLS AND BENCHES

Nienkämper River Designer - busk + hertzog

— CDN Only —

Model Number	Seat H"	W"	D"	H"	Fabric Yds.	Leather Sq.Ft.	COM	COL	Neather	Verde	Grano	Cremoso	Knoll Textiles			
													1	2	3	4

NIENKÄMPER RIVER BENCH: LEFT ELEMENT

Model	Seat H"	W"	D"	H"	Fabric Yds.	Leather Sq.Ft.	
	17	74	29	17			
		(full dimension)					
11842	fully upholstered				3½	63	
11842/1	contrasting fabric	body			3½		
	sides & Hollow				1		
11842/2	contrasting leather	body			63		
	sides & Hollow				18		

3,635	3,820	3,960	5,420	5,750	5,910	4,120	4,600	5,130	5,650
3,635		3,960				4,120	4,600	5,130	5,650
	3,820		5,420	5,750	5,910				

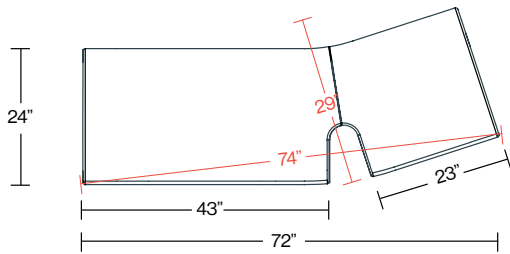

NIENKÄMPER RIVER BENCH: RIGHT ELEMENT

Model	Seat H"	W"	D"	H"	Fabric Yds.	Leather Sq.Ft.	
	17	74	29	17			
		(full dimension)					
11843	fully upholstered				3½	63	
11843/1	contrasting fabric	body			3½		
	sides & Hollow				1		
11843/2	contrasting leather	body			63		
	sides & Hollow				18		

3,635	3,820	3,960	5,420	5,750	5,910	4,120	4,600	5,130	5,650
3,635		3,960				4,120	4,600	5,130	5,650
	3,820		5,420	5,750	5,910				

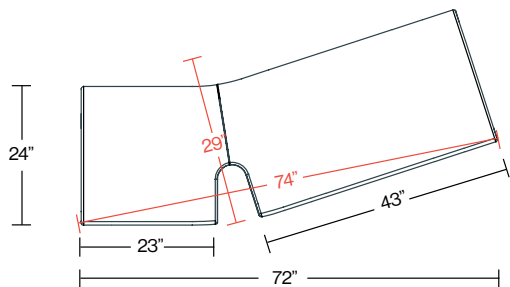

Model # 11842/1
River left element



Model # 11843/1
River right element



Standard features:

- Plywood frame with soy based flexible polyurethane seat foam
- Plastic glides at the bottom
- Contrasting leather or fabric upholstery can be specified for body, sides/hollow of the River bench with no upcharge
- More options of contrasting upholstery on the body of River bench is available with upcharge, please contact nienkämper customer service at 1-800-668-9318 for details

Optional features:

River has optional accessories available to be installed at "Hollow" Area:

- Coat Bar or support bar of the table is in aluminum finish available in black or white as standard
- Table top is in black marine-grade plastic as standard, veneer or P-lam option is also available with upcharge
- Single power outlet and stacked USB charger with 72" cord available in black or white as standard

Two centre elements (model #11841/1), one right element (model #11843/1) with two tables (model #11863) and coat bar (model #11862)



STOOLS AND BENCHES

Nienkämper River Designer - busk + hertzog

— CDN Only —

Model Number	Seat H"	W"	D"	H"	Fabric Leather		COM	COL	Neather	Verde	Grano	Cremoso	Knoll Textiles			
					Yds.	Sq. Ft.							1	2	3	4

NIENKÄMPER RIVER BENCH: CENTER ELEMENT

17 54 28 17
(full dimension)

11841	fully upholstered				3	54	2,920	3,070	3,195	4,430	4,695	4,825	3,335	3,745	4,200	4,650
11841/1	contrasting fabric	body			3		2,920		3,195				3,335	3,745	4,200	4,650
		sides & Hollow			1											
11841/2	contrasting leather	body			54			3,070		4,430	4,695	4,825				
		sides & Hollow			18											

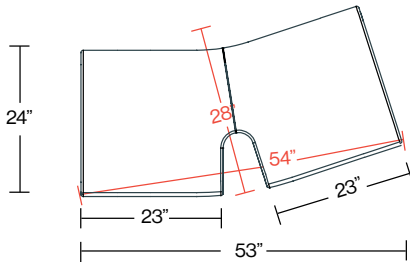

Nienkämper River Accessories at "Hollow" area

COAT BAR



11862					72		1,605
--------------	--	--	--	--	----	--	-------

TABLE



11863		16 dia.			25½		855
--------------	--	---------	--	--	-----	--	-----

POWER OUTLET



11864		2 dia.			2¼		285
--------------	--	--------	--	--	----	--	-----

STACKED USB CHARGER



11865		2 dia.			2		490
--------------	--	--------	--	--	---	--	-----

Standard features:

- Plywood frame with soy based flexible polyurethane seat foam
- Plastic glides at the bottom
- Contrasting leather or fabric upholstery can be specified for body, sides/ hollow of the River bench with no upcharge
- More options of contrasting upholstery on the body of River bench is available with upcharge, please contact nienkämper customer service at 1-800-668-9318 for details

Optional features:

River has optional accessories available to be installed at "Hollow" Area:

- Coat Bar or support bar of the table is in aluminum finish available in black or white as standard
- Table top is in black marine-grade plastic as standard, veneer or P-lam option is also available with upcharge
- Single power outlet and stacked USB charger with 72" cord available in black or white as standard

Model # 11841
River centre element



Model # 11865
Stacked USB charger at "Hollow" area



STOOLS AND BENCHES

Patkau Bench Designer - Patkau Architects

Model Number	W"	D"	H"	List Price
--------------	----	----	----	------------

PATKAUBENCH

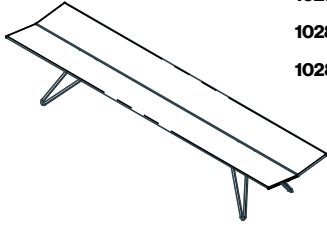

10281	48	21½	16½
10282	60	21½	16½
10283	72	21½	16½
10284	84	21½	16½
10285	96	21½	16½

9,360

9,970

10,640

11,150

11,665

Standard Features

- Seat Material Options: solid oak, walnut, maple (custom solids depend on specific availability)
- Frame Material: stainless steel rod
- Seat Finish: standard Nienkämper stains & finish
- Frame Finish: brushed stainless, powder coat satin black



Model # 10282 Patkau Bench



STOOLS AND BENCHES

Pullman™ Benches Designer - Nienkämper

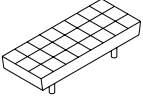
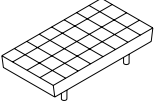
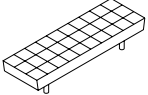
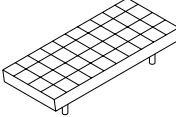
— CDN Only —

Model Number	Seat H"	W"	D"	H"	Fabric		COM	COL	Verde	Grano	Cremoso	Knoll Textiles											
					Yds.	Sq. Ft.						1	2	3	4								
BENCH (3 SQUARES X 8 SQUARES)																							
 15712 Fully Upholstered	16	64	25	16	3	56									3,880	4,075	5,985	6,530	6,745	4,290	4,705	5,160	5,605
BENCH (4 SQUARES X 8 SQUARES)																							
 15713 Fully Upholstered	16	64	33	16	3¾	70									4,335	4,540	6,940	7,625	7,910	4,850	5,370	5,935	6,490
BENCH (3 SQUARES X 10 SQUARES)																							
 15703 Fully upholstered	16	80	25	16	3½	65									4,440	4,655	6,875	7,520	7,760	4,915	5,400	5,930	6,455
BENCH (4 SQUARES X 10 SQUARES)																							
 15702 Fully upholstered	16	80	33	16	4¾	78									5,060	5,325	7,980	8,750	9,065	5,715	6,365	7,090	7,795
OTTOMAN																							
 15708 Fully upholstered	16	33	25	16	1¾	33									2,595	2,720	3,820	4,145	4,280	2,835	3,080	3,345	3,610
BOLSTER																							
 15705 Fully upholstered	6 dia.	23			¾	8									405	430	715	790	825	510	615	725	835

Pullman Bench

Fabric yardages are based on 54" width with no repeat, fabric must be railroaded, see Page 6 for instructions. The base is available in a brushed nickel finish as standard; add 5% for a polished chrome finish.

Model #15703
Pullman bench

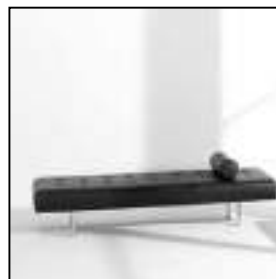





Model #15712
Pullman bench

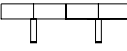
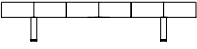

STOOLS AND BENCHES

Six® Collection Designer - Nienkämper

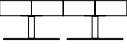
— CDN Only —



Model Number	Seat H"	W"	D"	Fabric		COM	COL	Neather	Verde	Grano	Cremoso	Knoll Textiles					
				Yds.	Sq.Ft.							1	2	3	4		
2 SEAT BENCH																	
 30303	17	63	31½	3	54	4,250	4,410	4,515	5,920	6,355	6,535	4,665	5,075	5,530	5,975		
3 SEAT BENCH																	
 30304	17	82	31½	4½	81	4,760	4,955	5,165	7,265	7,920	8,185	5,375	5,995	6,675	7,340		
OTTOMAN																	
 30305	17	28	27¾	1½	27	2,835	2,950	2,980	3,685	3,900	3,980	3,055	3,255	3,485	3,705		
OTTOMAN ON PEDESTALS																	
 30310	17	28	27¾	1½	27	2,125	2,235	2,260	2,960	3,175	3,265	2,335	2,535	2,760	2,980		
2 SEAT BENCH ON PEDESTALS																	
 30308	17	63	31½	3	54	3,525	3,695	3,805	5,200	5,640	5,815	3,940	4,355	4,805	5,250		
3 SEAT BENCH ON PEDESTALS																	
 30309	17	82	31½	4½	81	4,040	4,240	4,450	6,540	7,195	7,455	4,660	5,275	5,955	6,630		

Six Bench passes CAL 133 certified for an upcharge of \$635 per 2 seat bench, \$830 per 3 seat bench and \$380 per ottoman. Certification applies to Nienkämper leathers and fabrics that have a minimum of 50% natural fibre content. COM's and COL's are subject to approval. Add the extension "-CAL" to the model number when ordering.

STOOLS AND BENCHES

Spin Stool/Tables Designer - patty johnson

— CDN Only —

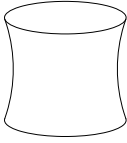
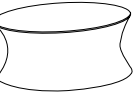
Model Number	W"	H"	Fabric Yds.	Leather Sq.Ft.	COM	COL	Neather	Verde	Grano	Creoso	Knoll 1	Textiles 2	3	4
SIDETABLE/STOOL														
	31901	12½	19¼											
	with Cushion													
	31901C			½	4	2,075	2,110	2,125	2,190	2,230	2,240	2,155	2,225	2,295 2,370
	31902	13½	13											
	with Cushion													
	31902C			½	4	1,815	1,845	1,855	1,925	1,955	1,970	1,885	1,955	2,030 2,110
	31904	22	19¼											
	with Cushion													
	31904C			1	10	3,675	3,700	3,770	3,940	4,040	4,060	3,820	3,950	4,105 4,255
COFFEE TABLE/STOOL														
	31903	24	10											
	with Cushion													
	31903C			1	10	2,195	2,235	2,295	2,475	2,565	2,595	2,345	2,480	2,620 2,780

Model #31903 & Model #31902 with black finish









Spin tables and stools are available in a clear or black, anodized finish specify at time of order.

Spin Tables/Stools are spun aluminum with a removable lid for storage capacity inside.

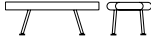

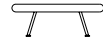



STOOLS AND BENCHES

Wavelength® Benches Designer - karim rashid



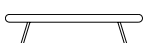

— CDN Only —

Model Number	Seat H"	W"	D"	H"	Fabric Leather		COM	COL	Verde	Grano	Cremoso	Knoll Textiles						
					Yds.	Sq. Ft.						1	2	3	4			
TWO SEAT BENCH																		
	1404_	16¾"	47¼"	23½"	16¾"													
	(Model #1)	Fully Upholstered				1½	24	3,950	4,145	4,845	5,090	5,180	4,160	4,370	4,595	4,815		
	(Model #2)	Fabric seat, fabric contrasting trim				¾	1½	3,950					4,060	4,160	4,275	4,385		
	(Model #3)	Leather seat, leather contrasting trim					12		4,145	4,845	5,090	5,180						
	(Model #4)	Fully Upholstered, rounded ends				1¾	28	3,950	4,145	4,845	5,090	5,180	4,200	4,440	4,700	4,965		
	(Model #5)	Fabric seat, fabric contrasting trim, rounded ends				1½	1¾	3,950					4,160	4,370	4,595	4,815		
	(Model #6)	Leather seat, leather contrasting trim, rounded ends					24		4,145	4,845	5,090	5,180						

THREE SEAT BENCH

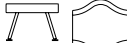
	1405_	16¾"	70¾"	23½"	16¾"													
	(Model #1)	Fully Upholstered				2¼	36	4,370	4,585	5,595	5,920	6,065	4,680	4,990	5,330	5,660		
	(Model #2)	Fabric seat, fabric contrasting trim				2¼	2¼	4,370					4,680	4,990	5,330	5,660		
	(Model #3)	Leather seat, leather contrasting trim					36		4,585	4,845	5,090	5,180						
	(Model #4)	Fully Upholstered, rounded ends				2½	40	4,370	4,585	5,595	5,920	6,065	4,710	5,055	5,435	5,805		
	(Model #5)	Fabric seat, fabric contrasting trim, rounded ends				2	2¼	4,370					4,650	4,915	5,220	5,525		
	(Model #6)	Leather seat, leather contrasting trim, rounded ends					32		4,585	5,595	5,920	6,065						

OTTOMAN

	1406_	16¾"	23¾"	23½"	16¾"													
	(Model #1)	Fully Upholstered				1	16	3,165	3,340	3,585	3,690	3,725	3,305	3,445	3,590	3,740		
	(Model #2)	Fabric seat, fabric contrasting trim				¾	½	3,165					3,275	3,375	3,490	3,595		
	(Model #3)	Leather seat, leather contrasting trim					12		3,340	3,585	3,690	3,725						

Wavelength Bench passes CAL 133 certified for an upcharge of \$505 list per 2 seat bench, \$760 list per 3 seat bench, \$380 list per ottoman. Certification applies to Nienkämper leathers and fabrics that have a minimum of 50% natural fibre content. COM's and COL's are subject to approval. Add the extension "-CAL" to the model number when ordering.

Fabric direction when railroaded

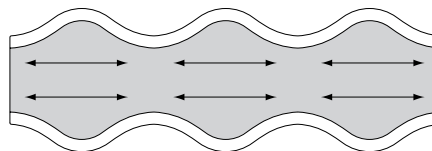

Wavelength Benches:

- Fabric yardages are based on plain fabrics with no apparent pattern direction. Fabric is railroaded.
- When upholstering in two different fabrics or leathers use the COM price or COL price and ship yardages or square footage as noted on page 6. Most fabrics and vinyl are suitable for the top seat portion but the contrasting trim must have stretch.
- Nienkämper reserves the right to determine the suitability of COM on our furniture. For further details regarding approvals, refer to page 6.
- specify polished or brushed aluminum frame.

Model #14041
Cast aluminum frame in polished aluminum



Model #14044
Two seat bench, polished aluminum frame





Model #14044
Two seat bench, rounded ends polished aluminum frame



Fabric to be upholstered on Wavelength requires approval from Nienkämper's factory. Please contact customer service at 800 668 9318 for our fabric approval list.

STOOLS AND BENCHES

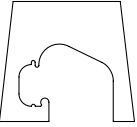
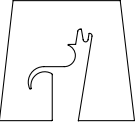
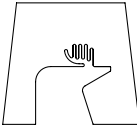
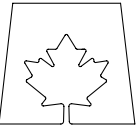
ZooStool Designer - Mouna & silvio russo

	Model Number	W"	D"	H"	List Price
BISON STOOL					
	20912	11	11	13¼	900
CAT STOOL					
	20911	11	11	13¼	900
DEER STOOL					
	20914	11	11	13¼	900
MAPLE LEAF STOOL					
	20915	11	11	13¼	900
SEAL STOOL					
	20913	11	11	13¼	900

Stackable Zoo Stools are constructed from FSC plywood core with laminate in bold primary colours:

Cat: yellow (Arborite Daffodil S480-CA)

Bison: blue (Abet 482SEI)

Seal: green (Abet 460SEI)

Deer: orange (Pionite bittersweet S0312)

Maple Leaf: red (Wilsonart Holly Berry D307-60)

Note: Custom colours and logos available for quantities of 4+

nienkämper

International Inc.

MEETING PODS



MEETING PODS

Patkau Cocoon Designer - Patkau Architects

Model Number	W"	D"	H"	Fabric Leather		COM	COL	Verde	Grano	Cremoso	— CDN Only — KnollTextiles			
				Yds.	Sq.Ft.						1	2	3	4
PATKAU COCOON														
10280	101½	105	104	4	130	67,810	70,290	74,005	75,180	75,780	68,915	70,005	71,215	72,410

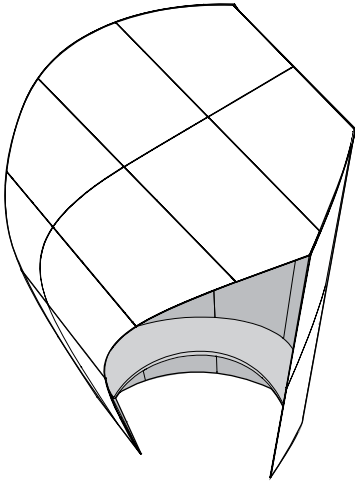

Standard features:

- Seat Upholstery: Leather and KnollTextiles
- Exterior Panel Finish: birch plywood natural finish
- Lighting: 12V pot lights (105 Lumen ea.) x 5 / motion detection switch.
- Power options mounted under seat



2 power, 1 USB charger



Dual USB charger

Model #10280



MEETING PODS

Patkau Ice Hut Designer - Patkau Architects

Model Number	W"	D"	H"	Fabric Leather		COM	COL	Verde	Grano	Cremoso	— CDN Only — Knoll Textiles			
				Yds.	Sq.Ft.						1	2	3	4

PATKAU ICE HUT

21000	60	60	96	9	162	47,075	49,435	58,265	59,370	60,470	48,195	49,320	50,550	51,810
--------------	----	----	----	---	-----	--------	--------	--------	--------	--------	--------	--------	--------	--------

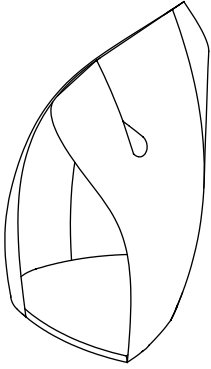

Model # 21000

