

**nienkämper**  
International Inc.

# SEATING & MEETING PODS

2024

# TABLE OF CONTENTS

<b>How to Order Nienkämper Seating</b>	<b>4</b>	<b>Lounge Seating</b>	<b>55-154</b>
<b>Upholstery Details</b>	<b>5-10</b>	32 Collection	56
Nienkämper Leather	5	Baden	57-58
Customer's Own Material (COM)	6	Bare	59
KnollTextiles	6	BASS Collection	60-61
Customer's Own Leather (COL)	6	Bay	62
Shipping Your Materials	6	Beam	63
KnollTextiles Categories and Index	7-10	Belle	64
<b>California Technical Bulletin 133</b>	<b>11</b>	Berkley® Collection	65-70
<b>Veneers / Finishes</b>	<b>12</b>	Bern	71
<b>Office Seating</b>	<b>13-42</b>	Blob	72
Rush Ship	15-16	BLOOR® Collection	73
AYA™	17	Carlisle	74
Emissary	18	Cocoon	75
Ingmar Conference	19	Divvi	76
Kris	20	Dobi	77
Nabu™	21-23	Dune Metal	78
Nienkämper NOW®	24-30	Dune Wood	79
Senator® Boardroom	31	Eden®	80-95
Senator® CEO	32	Elite	96
Senator® Classic	33	Expo 67	97
Senator® Executive	34	Godbout	98
Senator Mesh Back	35	HAB™	99
Senator® Nuvo Office	36	Heartbeat	100-101
Senit Chair	37	Ingmar Lounge	102
Shaker Chair	38	Isola 8	103
Slim	39	J + J Studio	104
Trench	40	Kloud® Collection	105
Vuelo	41	Kloud® Serpentine™	106
<b>Side Chairs</b>	<b>43-54</b>	LCS Club	107
Brackett®	44	Leaf	108
HSC	45	LINQ	109
Kush	46	LolliPOP	110
Nabu Side/Stacking Chair	47-49	Lucerne	111
Q Side Chair	50	Max™	112-118
Schultz	51	Mood Collection	119
Senator® Nuvo Sled Base	52	Nordic	120
Unesco™	53	Note	121
		Paris Archive	122
		Patkau Twist	123
		Polo Chair	124
		Pullman™	125-126
		Pyramid Chair	127
		Q Chair	128
		Radius	129

# TABLE OF CONTENTS

---

Radius on Legs	130
Rowan	131
Satori™	132
Six® Collection	133
Spirit	134
Turnaround® Collection	135
Tuxedo™	136-137
Tuxedo Classic™	138-141
Tuxedo Cove	142-145
Tuxedo™ High Back	146-147
Vuelo Lounge	148
Wavelength®	149-150
Work:Recline	151
Yabaco	152
Zurich	153-154

## **Stools and Benches 155-177**

32 Bench	157
Align	158
Blottoman™	159
Caravite	160
Corbu	161
Elevation Bench	162
Exhale	163
Hocker	164
Jackal	165
Kloud® Benches	166
Max™ Benches	167
Mint	168
Moment Collection	169
Nienkämper River	170-171
Patkau Bench	172
Pullman™ Benches	173
Six Collection® Benches	174
Spin Stool/Tables	175
Wavelength® Benches	176
Zoo Stools	177

<b>Meeting Pods 178-180</b>	
Patkau Cocoon	179
Patkau Ice Hut	180

# HOW TO ORDER NIENKÄMPER SEATING

---

## SELECT THE CHAIR:

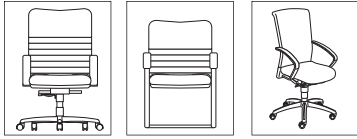

Select the style of chair that best suits your needs. All features are listed on each page.

### Sample:

Standard Features:

- Pneumatic height adjustment
- Back tilt locking mechanism
- Tension control
- Carpet casters
- Black five-star base

### Optional Features:

- Hard floor casters, add \$95 list per chair
- Glides, add \$95 list per chair
- Polished aluminum five-star base, add \$190 list
- Chrome finish sled base, add \$150 list

## SELECT YOUR ARM TYPE:



For each style of chair there are a number of arm options. These are listed under the model number with an extension. For example 1411\_ is the model number for the Senator Executive low back chair. Extension #1 specifies Urethane Arm, extension #3 specifies Urethane arm with cap & wrap, and so on.

### Sample:

1411\_

18½"-21½" 25" 25" 26" 36"

(Model #1) Urethane arm

fabric 1¼ Yds. leather 32 Sq. Ft.

(Model #2) Urethane arm with cap

fabric 2 Yds. leather 35 Sq. Ft.

(Model #3) Urethane arm with cap & wrap

fabric 2¼ Yds. leather 37 Sq. Ft.

## SELECT YOUR BASE:



At the end of each chair listing are notes indicating base options and finishes, where applicable. Review these notes and specify your base type and finish at the time you place your order.

### Cross Section Example:

Standard Features:

- Pneumatic height adjustment
- Back tilt locking mechanism
- Tension control
- Carpet casters
- Black five-star base

### Optional Features:

- Hard floor casters, add \$110 list per chair
- Glides, add \$110 list per chair
- Polished aluminum five-star base, add \$205 list
- Chrome finish sled base, add \$170 list

## SELECT YOUR OPTIONS:

Each chair has additional options to choose from, listed on each page.

Optional Features:

- Hard floor casters, add \$110 list per chair
- Glides, add \$110 list per chair
- Polished aluminum five-star base, add \$215 list
- Chrome finish sled base, add \$170 list

## SELECT YOUR FABRIC:

For each chair we have priced COM, COL, Nienkämper's three grades of leather and four grades of KnollTextiles. Refer to the row that corresponds to the chair you are ordering.

For information on COM and COL please refer to page 6.

## UPHOLSTERY DETAILS

---

### **NIENKÄMPER LEATHER:**

Nienkämper is universally known for its exquisite craftsmanship in leather furniture. Nienkämper leather on Nienkämper furniture offers you and your clients the highest quality of materials as well as favorable pricing. Our Verde and Grano leather is available as COL sold to the nearest half hide. Cremoso leather is available for Nienkämper furniture only.

#### **The Verde Collection:**

Available in 42 colors this collection provides a varied selection of neutrals, browns, reds and blues. It is organically tanned using a chrome-free process with a water-based semi-aniline finish. These improved techniques result in a more natural character, combined with a softer touch and brighter colors that are consistent from batch to batch.

Raw Material: Scandinavian Cow Hide

Thickness: 1.1-1.3 mm

Type: Chrome-free tanned with a water-based semi-aniline finish. Full natural grain, excellent durability yet soft and pliable, suitable for public environments. Some visible healed scars add natural character to this leather.

Average Hide Size: 55 sq.ft.

#### **The Grano Collection:**

The perfect balance between strength and softness. Semi-aniline Grano has exceptional natural beauty and pliancy. An easy-to-clean finish makes this leather appropriate for seating in reception areas, meeting rooms and managerial offices.

Raw Material: European Cow Hide

Thickness: 1.2-1.4 mm

Type: Semi-aniline dyed.

Average Hide Size: 55 sq.ft.

#### **The Neather Collection:**

Available in 8 colours, Neather is a synthetic material similar to vinyl. It comes in a standard 54" width. Neather is easy to clean and a good option for accessory or upholstery items.

To request leather samples please contact your local sales representative, for a listing or call Nienkämper Customer Service at 800.668.9318.

# UPHOLSTERY DETAILS

**CUSTOMER'S OWN MATERIALS (COM):**

Nienkämper reserves the right to determine the suitability of a particular COM on our furniture. If we determine, in our judgment, that the COM is inappropriate for use on a particular product we will notify the customer. If you have any questions on the appropriateness of your COM please submit a sample to Customer Service prior to your order.

**KNOLL TEXTILES:**

All Nienkämper seating available in fabric includes pricing for four grades of fabric, see the Knoll Textiles grade columns throughout this book. All fabric orders should be made when ordering the furniture. For Knoll Textiles samples contact the Knoll Textiles Customer Service department at 1.866.565.5858.

All yardage requirements are noted for each model number and option, refer to the pricing charts in this book. All yardage requirements shown in our price list are based on 54" plain material. Fabrics which have a repeat that must be matched, or are less than 54" wide, will require more yardage. Check with Customer Service before ordering. There may be yardage savings for quantity orders of the same model. Check with Customer Service before ordering. ALL COM WILL BE CUT AND APPLIED AT OUR DISCRETION UNLESS SPECIAL CUTTING INSTRUCTIONS ARE INCLUDED IN WRITING WITH THE ORDER. FABRIC PATTERNS SHOULD BE IDENTIFIED AS APPLIED VERTICALLY OR HORIZONTALLY ON A FRAME. WE CANNOT BE HELD RESPONSIBLE FOR RECEIPT OF DEFECTIVE FABRIC AS WE APPLY ALL COM AS FIRST QUALITY GOODS.

Fabric	Plain	2" - 14"	15" - 24"	25" - 27"	28" - 36"
Width	Fabric	Repeat	Repeat	Repeat	Repeat
54"	0%	10%	15%	20%	25%
50"	10%	20%	25%	30%	35%
48"	15%	25%	30%	35%	40%
45"	40%	50%	55%	60%	65%
36"	50%	60%	65%	70%	75%

We cannot be held responsible if yardage supplied is insufficient to complete an order.

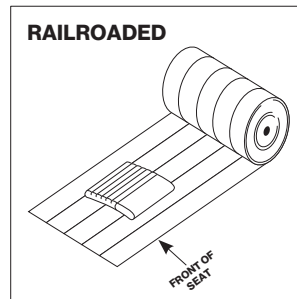
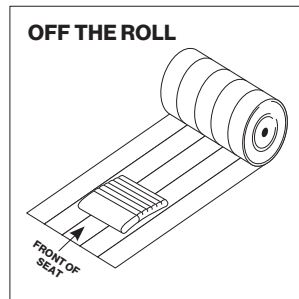

**CUSTOMER'S OWN LEATHER:**

All furniture listed in this price list that is available with leather has pricing in COL, refer to the COL column throughout this book. Leather is applied to avoid scars, however, some markings are inherent in this natural material. Square footage requirements are based on cow hides measuring 50 sq.ft. per hide. Consult Nienkämper's Customer Service Department for square footage requirements before ordering when using hides that do not meet these requirements. Application instructions must accompany all COL orders. In the absence of these instructions Nienkämper will determine the best method of upholstery.

**SHIPPING YOUR MATERIALS:**

For Canada  
Customer supplied material must be sent prepaid to:

Nienkämper International, Inc.  
257 Finchdene Square  
Toronto, Ontario  
Canada M1X 1B9

From all locations outside of Canada  
Customer supplied material must be sent prepaid to:

Livingston International  
c/o Nienkämper  
257 Finchdene Square  
Toronto, Ontario  
Canada M1X 1B9

All packages must include a copy of a commercial invoice showing the exact yardage, value and fibre content of the fabric and must indicate our order confirmation number, or customer's purchase order number, and the furniture for which it is intended.

# UPHOLSTERY DETAILS

An index of KnollTextiles fabric follows. Contact KnollTextiles customer service at 1.800.237.1625 for an updated listing. For fabric not graded in, please contact customer service for pricing.

## ALPHABETICAL INDEX:

CATEGORY 1			
Attire	K2340	Patchwork*	K2292
Axiom*	K1650	Petal Pusher*	K1968
Bistro	K1775	Prairie*	K1925
Boundary*	K1828	Prep*	K1076
Brigadoon*	K2167	Presto	K1000
Chameleon*	K2372	Prim*	K1884
Chance	K1552	Pullman	K2124
Code	K2251	Ransom	K1298
Color Field*	K2226	Retreat*	K2367
Commuter Cloth	K1778	Roam	K1657
Cross Tech	K2279	Rush Hour	K1824
Crossroad	K2085	Sonnet	K1460
Day Tripper	K2248	Spree	K1600
Delite	K2026	Stripemania*	K2225
Diva	K2051	Summit	K2020
Dottie	K2259	Sutton	K1750
Dune*	K2047	Synth	K1693
Entwine	K2355	Tabloid	K2022
Essence*	K2059	Tight Rope*	K1798
Ferry	K1697	Tilden*	K1779
Greenwich*	K1753	Tinge*	K2068
Groovy*	K2242	Topos*	K2397
Helios	K2089	Trophy	K1709
Holbrook	K1928	Uni-Form	K2125
Hourglass	K1523	Utopia*	K2371
Infinite	K2263	Venue	K1558
Instinct	K2258	Versa	K1698
Journey	K1806	Vibe II*	K2154
Kaya CR	K2122	Vinyl	K242
Keaton	K1596	Westwood*	K1949
Knoll Felt	K1207	Wild Thing*	K2240
Knoll Hopsack	K1206	Wit*	K2050
Little Devil	K2112	Yeni	K2082
Ludlow	K1998	Zen Wave	K2078
Magnolia*	K1999		
Melody*	K2067		
Monarch	K1149		
Oh La La	K2201		
On Point*	K2293		
Overture	K2169		
Palisade*	K2030		

CATEGORY 2			
Abacus	K715	Menagerie	K1322
Aegean	K2074	Midpoint	K2123
Alter Ego	K2140	Milestone*	K1886
Arrondissement	K2200	Mod Plaid	K1630
Atlas*	K1236	Modern Tweed	K2155
Biscayne	K1771	Nature Walk*	K2081
Buzz	K2373	Paradigm	K1101
Cameo	K1443	Plaidtastic*	K2238
Charm	K1049	Premier*	K2294
Chronicle	K1525	Quark	K781
Circa	K1054	Radiance	K1921
Cleo	K2168	Rebel	K2261
Color Collage	K2349	Sahara	HC1269
Dapper	K2338	Seurat	K2151
Demure LUXE	K2023	Sherman	K1789
Double Agent	K2199	Shima	K1468
Dristi	K872	Sideline*	K2210
Durand*	K1885	Sinclair*	K1555
Eclat Weave	K1104	Smart	K1268
Fancy Twill	K2348	Spot On	K1324
Feeling Plaid	K2150	Stepping Stones	K346
Glider	K1717	Swing	K479
Grandview*	K1463	Tempest	K2377
Highland	K2010	Totem	K1561
Hudson*	K1765	Utmost II	K2358
Ikat Square	K1703	Vatera	K2071
Imprint	K2333	Vice Versa*	K2361
In Stitches	K2190	Whip*	K1386
Island*	K2053	Woodland*	K2049
It's Complicated*	K2252	Zari CR	HC1008
Juno	K2152	Utmost II	K2358
Kabuki	K2084	Vatera	K2071
Katazome	K1459	Vice Versa*	K2361
Kimono	K1174	Whip*	K1386
Lore CR	HC1123	Woodland*	K2049
Marquee	K1608	Zari CR	HC1008

\* Fabric with "\*" is Bleach Cleanable

## UPHOLSTERY DETAILS (CONTINUED)

An index of KnollTextiles follows. Contact KnollTextiles customer service at 1.800.237.1625 for an updated listing. For fabric not graded in, please contact customer service for pricing.

### ALPHABETICAL INDEX:

CATEGORY 3	
All Star LUXE	K2209
Amore LUXE	K2080
Arezzo LUXE	K1442
Aswan	K2046
Atelier	K1607
Calais Cotton Velvet	K787
Catwalk	K2156
Chiseled	K2249
Doyenne LUXE	K2353
Floressence	K2357
Haze	K109
In Step	K2375
Jasmine LUXE	K2077
Kamani LUXE	K1580
Petite Floral LUXE	K2087
Rivington	K1080
Stretch Appeal	K2188
Striae Stripe	K1827
Stripe It*	K2368
Tara LUXE	K1967
Tivoli LUXE	K2063
Tryst	K1522
Twist Tie	K2264
Ultrasuede	K1021
Utrillo	K1807
World Piece	K2208

CATEGORY 4	
Bavaria LUXE	K1160
Chic LUXE	K2351
Constance LUXE	K1527
Cummings LUXE	K1378
Diamond Days LUXE	K1756
Duchess LUXE	K1209
Dynamic	K1617
Gibson	K1086
Hastings LUXE	K1087
Olema LUXE	K1764
Piper LUXE	K1706
Prince Hairy LUXE	K2237
Rutledge LUXE	K1707
Spencer	K1106
Tudor LUXE	K1579
Zimba LUXE	K1669

\* Fabric with "\*" is Bleach Cleanable



## UPHOLSTERY DETAILS (CONTINUED)

An index of KnollTextiles follows. Contact KnollTextiles customer service at 1.800.237.1625 for an updated listing. For fabric not graded in, please contact customer service for pricing.

### NUMERICAL INDEX:

CATEGORY 1			
Vinyl	K242	Palisade*	K2030
Presto	K1000	Dune*	K2047
Prep*	K1076	Wit*	K2050
Monarch	K1149	Diva	K2051
Knoll Hopsack	K1206	Essence*	K2059
Knoll Felt	K1207	Melody*	K2067
Ransom	K1298	Tinge*	K2068
Sonnet	K1460	Zen Wave	K2078
Hourglass	K1523	Yeni	K2082
Chance	K1552	Crossroad	K2085
Venue	K1558	Helios	K2089
Keaton	K1596	Little Devil	K2112
Spree	K1600	Kaya CR	K2122
Axiom*	K1650	Pullman	K2124
Roam	K1657	Uni-Form	K2125
Synth	K1693	Vibe II*	K2154
Ferry	K1697	Brigadoon*	K2167
Versa	K1698	Overture	K2169
Trophy	K1709	Oh La La	K2201
Sutton	K1750	Stripemania*	K2225
Greenwich*	K1753	Color Field*	K2226
Bistro	K1775	Wild Thing*	K2240
Commuter Cloth	K1778	Groovy*	K2242
Tilden*	K1779	Day Tripper	K2248
Tight Rope*	K1798	Code	K2251
Journey	K1806	Instinct	K2258
Rush Hour	K1824	Dottie	K2259
Boundary*	K1828	Infinite	K2263
Prim*	K1884	Cross Tech	K2279
Prairie*	K1925	Patchwork*	K2292
Holbrook	K1928	On Point*	K2293
Westwood*	K1949	Attire	K2340
Petal Pusher*	K1968	Entwine	K2355
Ludlow	K1998	Retreat*	K2367
Magnolia*	K1999	Utopia*	K2371
Summit	K2020	Chameleon*	K2372
Tabloid	K2022	Topos*	K2397
Delite	K2026	Utopia*	K2371
Summit	K2020	Chameleon*	K2372
Tabloid	K2022	Topos*	K2397
Delite	K2026		

CATEGORY 2			
Zari CR	HC1008	Milestone*	K1886
Lore CR	HC1123	Radiance	K1921
Sahara	HC1269	Highland	K2010
Stepping Stones	K346	Demure LUXE	K2023
Swing	K479	Woodland*	K2049
Abacus	K715	Island*	K2053
Quark	K781	Vatera	K2071
Dristi	K872	Aegean	K2074
Charm	K1049	Nature Walk*	K2081
Circa	K1054	Kabuki	K2084
Paradigm	K1101	Midpoint	K2123
Eclat Weave	K1104	Alter Ego	K2140
Kimono	K1174	Feeling Plaid	K2150
Atlas*	K1236	Seurat	K2151
Smart	K1268	Juno	K2152
Menagerie	K1322	Modern Tweed	K2155
Spot On	K1324	Cleo	K2168
Whip*	K1386	In Stitches	K2190
Cameo	K1443	Double Agent	K2199
Katazome	K1459	Arrondissement	K2200
Grandview*	K1463	Sideline*	K2210
Shima	K1468	Plaidtastic*	K2238
Chronicle	K1525	It's Complicated*	K2252
Sinclair*	K1555	Rebel	K2261
Totem	K1561	Premier*	K2294
Marquee	K1608	Imprint	K2333
Mod Plaid	K1630	Dapper	K2338
Ikat Square	K1703	Fancy Twill	K2348
Glider	K1717	Color Collage	K2349
Hudson*	K1765	Utmost II	K2358
Biscayne	K1771	Vice Versa*	K2361
Sherman	K1789	Buzz	K2373
Durand*	K1885	Tempest	K2377

\* Fabric with "\*\*\*" is Bleach Cleanable

## UPHOLSTERY DETAILS (CONTINUED)

An index of KnollTextiles follows. Contact KnollTextiles customer service at 1.800.237.1625 for an updated listing. For fabric not graded in, please contact customer service for pricing.

### NUMERICAL INDEX:

CATEGORY 3	
Haze	K109
Calais Cotton Velvet	K787
Ultrasuede	K1021
Rivington	K1080
Arezzo LUXE	K1442
Tryst	K1522
Kamani LUXE	K1580
Atelier	K1607
Utrillo	K1807
Striae Stripe	K1827
Tara LUXE	K1967
Aswan	K2046
Tivoli LUXE	K2063
Jasmine LUXE	K2077
Amore LUXE	K2080
Petite Floral LUXE	K2087
Catwalk	K2156
Stretch Appeal	K2188
World Piece	K2208
All Star LUXE	K2209
Chiseled	K2249
Twist Tie	K2264
Doyenne LUXE	K2353
Floressence	K2357
Stripe It*	K2368
In Step	K2375

CATEGORY 4	
Gibson	K1086
Hastings LUXE	K1087
Spencer	K1106
Bavaria LUXE	K1160
Duchess LUXE	K1209
Cummings LUXE	K1378
Constance LUXE	K1527
Tudor LUXE	K1579
Dynamic	K1617
Zimba LUXE	K1669
Piper LUXE	K1706
Rutledge LUXE	K1707
Diamond Days LUXE	K1756
Olema LUXE	K1764
Prince Hairy LUXE	K2237
Chic LUXE	K2351

\* Fabric with "\*" is Bleach Cleanable

# CALIFORNIA TECHNICAL BULLETIN 133

---

All chairs utilize California Bulletin 117 approved fire retardant, CFC-free polyurethane foam.

California 133 - Nienkämper seating designs can be manufactured to meet California Technical Bulletin 133. Certification applies to Nienkämper leathers and fabrics that have a minimum 50% natural fibre content. COM/COL's must be evaluated on an individual basis which may require testing of fabric on the furniture. Testing may require additional cost and lead time.

-Cost of testing a chair is \$750 NET, plus cost of product.

-Additional lead time for testing is 6 weeks.

-See individual product pages for seating that has been tested, applicable upcharge for CAL 133 stated on product page.

Boston Fire Code - Boston has adopted California 133 standards. All information pertaining to California Technical Bulletin 133 as stated above satisfies the Boston Fire Code.

<b>CAL 133 Available</b>	<b>Page</b>
<b>Office Seating:</b>	
Nabu™ Office Chair.....	21-22
Nienkämper NOW® .....	25
Senator® Boardroom.....	32
Senator® CEO .....	33
Senator® Executive .....	35
<b>Side Chairs:</b>	
Nabu™ Side Chair .....	47-48
<b>Lounge Seating:</b>	
Baden/Zurich.....	57-58
Berkley® Collection.....	64-67
Carlisle.....	73
Cocoon .....	74
Eden.....	77-92
Kloud Collection.....	102
Max™ .....	108-113
Satori™.....	126
Six® Collection.....	127
Spirit.....	128
Tuxedo™.....	130
Tuxedo™ Classic.....	132-135
Tuxedo™ High Back.....	140
Wavelength® .....	143-144
<b>Benches:</b>	
Blottoman.....	151
Elevation Bench.....	154
Max™ Benches.....	159
Six® Bench.....	166
Wavelength® Bench .....	168

Note: Add the extension "-CAL" at the end of each model number for each chair ordered as CAL 133 certified. For example, a Senator Executive, low back chair on casters with urethane arm, CAL 133 certified would be Model # 14111-CAL.

## VENEERS

All wood surfaces are protected with a durable polyurethane clear laquer with UV inhibitor. This finish is known for its exceptional durability, as well as abrasion, chemical, impact and scratch resistance. Standard sheen level is 45 degrees. Optional 10 and 35 degree sheen levels are available on request at no additional cost.

Wood Species	Order Code	Veneer/Stain	Upcharge
Maple	F-01	Natural Maple	No upcharge applies.
	F-02	Natural Curly Maple - Rotary Cut	Add 15%.
	F-03	Natural Bird's Eye Maple - Rotary Cut	Call Customer Service for pricing.
	F-04	Maple Stained Pear	No upcharge applies.
Cherry	F-05	Natural Cherry	No upcharge applies.
	F-06	Standard Cherry	No upcharge applies.
	F-07	Cherry Stained Amber	No upcharge applies.
	F-08	Cherry Stained Auburn	No upcharge applies.
	F-09	Cherry Stained Burgundy	No upcharge applies.
Mahogany	F-10	Light Mahogany	No upcharge applies.
	F-11	Medium Mahogany	No upcharge applies.
	F-12	Dark Mahogany	No upcharge applies.
	F-13	Red Mahogany	No upcharge applies.
Anagre	F-14	Natural Figured Anagre - Qtr. Cut Book-Match	Add 15%.
	F-15	Figured Anagre Stained Amber - Qtr. Cut Book-Match	Add 15%.
Sycamore	F-16	Natural Figured Sycamore - Qtr. Cut Book-Match	Add 15%.
Walnut	F-17	Burnt Walnut	No upcharge applies.
	F-19	Natural Walnut	No upcharge applies.
	F-24	Carbon Grey Walnut	No upcharge applies.
White Oak	F-18	Natural White Oak - Flat Cut Book-Match (10° sheen)	No upcharge applies.
		Natural White Oak - Rift Cut Slip-Match (10° sheen)	Add 5%
Sapele – Ribbon Stripe	F-20	Natural Ribbon Strip Sepele - Qtr. Cut Slip-Match	No upcharge applies.
Moabe (Cherry substitute)	F-21	Natural Moabe - Quarter - Qtr. Cut Book-Match	No upcharge applies.
Cape Coast Walnut	F-22	Dark Cape Coast Walnut - Qtr. Cut Slip-Match	No upcharge applies.
	F-23	Natural Cape Coast Walnut - Qtr. Cut Slip-Match	No upcharge applies.
Ash	F-25	Slate Grey Ash - Qtr. Cut Slip-Match	No upcharge applies.

## VENEER GRAIN OPTIONS

Nienkamper products utilize the best quality veneers available, and, combined with Nienkämper's patented veneering systems, create work environments of incredible quality and beauty.

All veneer furniture comes standard with flat cut book-match veneer; flat cut slip-match veneer can also be specified. Quarter cut slip-match and quarter cut book-match veneers are available at a 5% upcharge. Figured Anagre and Figured Sycamore veneers are Quarter cut book-matched. Bird's Eye Maple and Curly Maple are rotary cut.

Facet Edge, Taper edge and Flowform edge tops with veneer are manufactured with a solid wood edge. All edges are then veneer wrapped to create a seamless profile top.

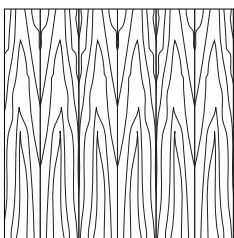

Standard Flat Cut Book-Match V1

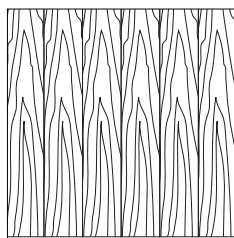

Flat Cut Slip-Match V2

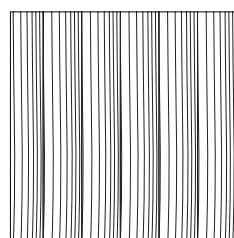

Quarter Cut Slip-Match Add 5% V3

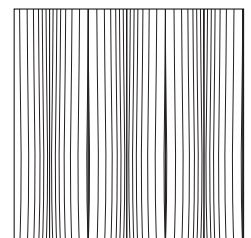

Quarter Cut Book-Match Add 5% V4

**nienkämper**

International Inc.

OFFICE SEATING



# OFFICE SEATING

## TABLE OF CONTENTS

---

<b>Office Seating</b>	<b>14-42</b>
Rush Ship	15-16
AYA™	17
Emissary	18
Ingmar Conference	19
Kris	20
Nabu™	21-23
Nienkämper NOW®	24-30
Senator® Boardroom	31
Senator® CEO	32
Senator® Classic	33
Senator® Executive	34
Senator Mesh Back	35
Senator® Nuvo Office	36
Senit Chair	37
Shaker	38
Slim	39
Trench	40
Vuelo	41

## Need chairs fast? 10 day delivery.

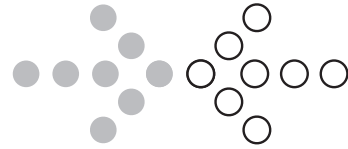

**Model 10932**



**Model 10602**

Within 10 business days from receipt of order, Nienkämper will deliver, 1 to 20:

- #14659 Senator Boardroom chair, upholstered in Verde Black leather, medium back, urethane arms with wrap.
- #14122 Senator Executive chair, medium back, urethane arms with cap, upholstered in Verde Black leather, black pneumatic base.
- #13022 Nienkämper NOW<sup>®</sup> Chair, upholstered in Verde black leather, polished arm supports, polished aluminum base, chrome casters.
- #13024 Nienkämper NOW<sup>®</sup> Chair, upholstered in Verde black leather, black base, black casters.
- #13060 Nienkämper NOW<sup>®</sup> Chair, upholstered in Verde black leather, multifunctional armrests, polished aluminum base, chrome casters.
- #10602 Nabu™ Chair with black (7209-BE) striped mesh back and seat, black base, cantilever arms.

Contact your representative to place your Rush Ship order. Effective January 1, 2020.

To Rush Ship call: **800.668.9318**

In Toronto call: **416.298.5700**

## Need chairs fast? 10 day delivery.

To Rush Ship call: **800 668 9318**

In Toronto call: **416 298 5700**



Nienkämper NOW® Medium Back  
**Model 13022, 13024 or 13060**



Senator® Boardroom Medium Back  
**Model 14659**



Senator® Executive Medium Back  
**Model 14122**



Nabu™  
**Model 10602**

Nienkämper  
Corporate Office  
Contract Showroom & Factory

257 Finchdene Square  
Toronto, Ontario  
Canada M1X 1B9  
[www.nienkamper.com](http://www.nienkamper.com)

Tel 800.668.9318  
Tel 416.298.5700  
Fax 416.298.9535  
[mail@nienkamper.com](mailto:mail@nienkamper.com)



# OFFICE SEATING

AYA™ Designer - Mark Saffell and David Ritch

— US Only —

Model Number	Seat H"	Arm H"	W"	D"	H"	Fabric Yds.	Leather Sq. Ft.	COM	COL	Verde	Grano	Cremoso	Knoll Textiles			
													1	2	3	4

## MEDIUM BACK

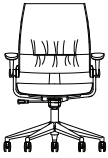

<b>13301</b> Black Base	18-21	24-27	26½	26	36-39	1¼	28	2,335	2,455	3,105	3,355	3,445	2,500	2,645	2,810	2,980
<b>13302</b> Polished Aluminum with Black Casters	18-21	24-27	26½	26	36-39	1¼	28	2,460	2,585	3,240	3,485	3,565	2,625	2,780	2,940	3,115
<b>13305</b> Polished Aluminum with Chrome Casters	18-21	24-27	26½	26	36-39	1¼	28	2,485	2,605	3,265	3,505	3,590	2,650	2,800	2,965	3,135

## HIGH BACK

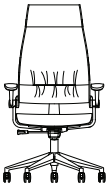

<b>13303</b> Black Base	18-21	24-27	26½	26	45-48	2	34	2,940	3,080	3,885	4,185	4,280	3,135	3,305	3,495	3,690
<b>13304</b> Polished Aluminum with Black Casters	18-21	24-27	26½	26	45-48	2	34	3,070	3,200	4,015	4,320	4,405	3,265	3,435	3,620	3,815
<b>13306</b> Polished Aluminum with Chrome Casters	18-21	24-27	26½	26	45-48	2	34	3,090	3,240	4,040	4,340	4,440	3,285	3,455	3,640	3,835



**Model # 13305**  
Medium Back



The ultimate in ergonomic elegance, the AYA™ Chair is based on the principles of natural body motion when reclining. The simplicity of function uses the occupant's own weight to control the seating position. As you recline and stop, the chair will stay in that position. There is no tension control, as the weight of the occupant rides up a ten degree incline, using gravity as the resistance and friction as the position control. There is only one control on the chair which adjusts height and locks the seat in one of five positions.

# OFFICE SEATING

Emissary Chair Designer – Aaron duke

Model Number	Seat H"	Arm H"	W"	D"	H"	Fabric Yds.	Leather Sq.Ft.	COM	COL	Neather	Verde	Grano	Cremoso	— US Only — KnollTextiles				
														1	2	3	4	
<b>EMISSARY LOW BACK</b>																		
	10061	18½-21	25-28	25	24	39-42	1¼	32	2,395	2,520	2,575	3,385	3,565	3,660	2,570	2,715	2,885	3,055
<b>EMISSARY MEDIUM BACK</b>																		
	10062	18½-21½	25-28	25	24	44-47	2	36	2,405	2,535	2,610	3,505	3,705	3,810	2,600	2,775	2,960	3,150
<b>EMISSARY HIGH BACK</b>																		
	10063	18½-21½	25-28	25	24	49-52	2¼	41	2,430	2,560	2,650	3,670	3,895	4,010	2,645	2,835	3,055	3,275

**Standard Features**

- Soy based rigid polyurethane inner shell
- Over moulded with soy based flexible polyurethane foam
- Pneumatic height adjustment
- Back tilt locking mechanism
- Carpet casters
- Black five-star base & casters
- Leather upholstered arm cap
- For chair with COM & KnollTextiles upholstery finish, leather upholstered arm cap is available in Nienkämper Verde/Grano/Cremoso leather

**Optional Features**

- Hard floor casters, add \$105 list per chair
- Glides, add \$105 list per chair
- Polished aluminum five-star base with chrome casters, add \$70 list

Model # 10063



Emissary high back chair fully upholstered in Cremoso leather, black CM795 with polished chrome base

# OFFICE SEATING

Ingmar Chair with Swivel Base Designer – Nienkämper

— US Only —

Model Number	Seat H"	Arm H"	W"	D"	H"	Fabric Yds.	Leather Sq.Ft.	COM	COL	Verde	Grano	Cremoso	Knoll Textiles			
													1	2	3	4

## INGMAR CHAIR WITH CHANNEL SLING



<b>13904</b>	19½	26	23	24	40	1½	18	3,375	3,545	4,035	4,140	4,185	3,515	3,650	3,790	3,935
--------------	-----	----	----	----	----	----	----	-------	-------	-------	-------	-------	-------	-------	-------	-------

## INGMAR CHAIR WITH SADDLE LEATHER SLING



<b>13905</b>	19½	26	23	24	40	1½	18	specify Brown (IVT05) or Black (IVT06)								
--------------	-----	----	----	----	----	----	----	--	--	--	--	--	--	--	--	--

specify Brown (IVT05) or Black (IVT06)

3,810

## INGMAR CHAIR WITH MESH SLING



<b>13906</b>	19½	26	23	24	40	1½	18	specify Black (IM01), Racing Green (IM02), or Beige (IM03)								
--------------	-----	----	----	----	----	----	----	--	--	--	--	--	--	--	--	--

specify Black (IM01), Racing Green (IM02), or Beige (IM03)

2,940

### Standard Features

- natural cherry, maple or walnut frame
- stained to match available: wood finish available in standard Nienkämper
- stains; to match custom stain add \$570 list per each stain colour
- channel sling available in fabrics and leathers
- saddle leather sling available in Brown (IVT05) or Black (IVT06)
- mesh sling available in Black (IM01), Racing Green (IM02) or Beige (IM03)
- chrome base and chrome casters



**Model # 13904**  
Ingmar with channel sling



# OFFICE SEATING

Kris Conference Chair Designer – BangDesign

— US Only —

Model Number	Seat H"	Arm H"	W"	D"	H"	Fabric Yds.	Leather Sq.Ft.	COM	COL	Neather	Verde	Grano	Cremoso	Knoll Textiles			
														1	2	3	4
<b>MEDIUM BACK</b>																	
<b>11461</b>	19-22	24-27	26	27	40½-43½	3½	32	2,485	2,605	2,795	3,355	3,660	3,735	2,800	3,090	3,400	3,720
																	
<b>HIGH BACK</b>																	
<b>11462</b>	19-22	24-27	26	27	49-52	3½	40	2,885	3,020	3,235	3,960	4,335	4,450	3,230	3,550	3,895	4,245
																	
<b>UPHOLSTERED ARM CAPS</b>																	
						½	2	90	95	140	140	155	160	145	180	240	280

**Model # 11461**  
Kris Medium Back



**Model # 11462**  
Kris High Back





## Standard Features

- Polished Aluminum base with black painted underside
- Frames are molded plywood
- Cushions are molded foam with 25 percent soy foam content
- Black polyurethane arm caps with brushed underside
- Upholstered arm caps an option
- Powder coat arms available upon request
- Black casters

# OFFICE SEATING

Nabu™ Chair – striped mesh back Designer – BangDesign

— US Only —

Model Number	Seat H"	Arm H"	W"	D"	H"	Fabric Yds.	Leather Sq.Ft.	COM	COL	Neather	Verde	Grano	Cremoso	Knoll Textiles											
														1	2	3	4								
<b>NABU™ CHAIR WITH CANTILEVER ARMS</b>																									
	<b>10601</b>	17½-21	25½-29	23½	25½	35-38½	¾	9	upholstered seat with striped mesh back						1,165	1,205	1,215	1,350	1,400	1,450	1,235	1,295	1,375	1,445	
	<b>10602</b>	17½-21	25½-29	23½	25½	35-38½			mesh seat with striped mesh back						1,180										
<b>NABU™ CHAIR WITH ADJUSTABLE ARMS</b>																									
	<b>10609</b>	17½-21	24½-28	24½	25½	35-38½	¾	9	upholstered seat with striped mesh back						1,190	1,235	1,250	1,375	1,435	1,480	1,260	1,320	1,400	1,470	
	<b>10610</b>	17½-21	24½-28	24½	25½	35-38½			mesh seat with striped mesh back						1,210										
<b>NABU™ CHAIR ARMLESS</b>																									
	<b>10603</b>	17½-21		20	25½	35-38½	¾	9	upholstered seat with striped mesh back						1,075	1,105	1,130	1,275	1,310	1,360	1,150	1,210	1,285	1,360	
	<b>10604</b>	17½-21		20	25½	35-38½			mesh seat with striped mesh back						1,095										

**Nabu™ Chairs (striped mesh back) are available as CAL 133 certified for an upcharge of \$135 list per chair. Certification applies to Nienkämper leathers and fabrics that have a minimum of 50% natural fibre content. COM's and COL's are subject to approval. Add the extension "-CAL" to the model number when ordering.**

**NOTE:**

- Teller Stool (height: 43" - 53") add "T" at the end of model # with an upcharge of \$200 list per chair.

**Standard features:**

- Seat available in 29 solid mesh colors. Back available in 34 contrasting mesh stripe. Back mesh has a horizontal stripe pattern as standard created by the strong elastomer fiber woven in the mesh.
- Cushions are molded foam with 25% soy foam content
- Spring loaded pivot action provides a rocking motion 6 degrees back and 3 degrees forward.
- Knee tilt action with tension control and 4 position back lock available for an upcharge of \$85 list
- Swivel base is black as standard; add \$70.00 list for polished aluminum with chrome casters
- Tubular steel leg or sled base is standard silver powder coat
- Back frame and arms are black as standard.
- Models 10605 through 10608 are stackable - 6 high on floor and 10 high on dolly. Footprint 23" wide x 32" deep.
- Dolly priced separately.

Model # 10601



Model # 10609



Model # 10603





Model # 10602T



# OFFICE SEATING

Nabu™ Chair – fully upholstered back Designer – BangDesign

— US Only —

Model Number	Seat H"	Arm H"	W"	D"	H"	Fabric Yds.	Leather Sq. Ft.	COM	COL	Neather	Verde	Grano	Cremoso	Knoll Textiles										
														1	2	3	4							
<b>NABU™ CHAIR WITH CANTILEVER ARMS</b>																								
	10611	17½-21	25½-29	23½	25½	35-38½	1½	24	fully upholstered seat and back						1,415	1,470	1,485	1,615	1,665	1,710	1,560	1,690	1,830	1,975
	10612	17½-21	25½-29	23½	25½	35-38½	¾	9	mesh seat with fully upholstered back						1,450	1,490	1,460	1,585	1,615	1,640	1,525	1,590	1,655	1,735
<b>NABU™ CHAIR WITH ADJUSTABLE ARMS</b>																								
	10619	17½-21	24½-28	24½	25½	35-38½	1½	24	fully upholstered seat and back						1,455	1,495	1,505	1,640	1,695	1,735	1,600	1,730	1,865	2,020
	10620	17½-21	24½-28	24½	25½	35-38½	¾	9	mesh seat with fully upholstered back						1,480	1,525	1,490	1,615	1,645	1,680	1,555	1,615	1,690	1,760
<b>NABU™ CHAIR ARMLESS</b>																								
	10613	17½-21		20	25½	35-38½	1½	24	fully upholstered seat and back						1,340	1,375	1,400	1,535	1,585	1,630	1,480	1,610	1,750	1,900
	10614	17½-21		20	25½	35-38½	¾	9	mesh seat with fully upholstered back						1,360	1,400	1,375	1,505	1,535	1,575	1,430	1,495	1,570	1,640

**Nabu™ Chairs (fully upholstered back) are available as CAL 133 certified for an upcharge of \$135 list per chair. Certification applies to Nienkämper leathers and fabrics that have a minimum of 50% natural fibre content. COM's and COL's are subject to approval. Add the extension "-CAL" to the model number when ordering.**

**NOTE:**

- Teller Stool (height: 43" - 53") add "T" at the end of model # with an upcharge of \$200 list per chair.

**Standard features:**

- Seat available in 29 solid mesh colors. Back available in 34 contrasting mesh stripe. Back mesh has a horizontal stripe pattern as standard created by the strong elastomer fiber woven in the mesh.
- Cushions are molded foam with 25% soy foam content
- Spring loaded pivot action provides a rocking motion 6 degrees back and 3 degrees forward.
- Knee tilt action with tension control and 4 position back lock available for an upcharge of \$85 list
- Swivel base is black as standard; add \$70.00 list for polished aluminum with chrome casters
- Tubular steel leg or sled base is standard silver powder coat
- Back frame and arms are black as standard.
- Models 10605 through 10608 are stachable - 6 high on floor and 10 high on dolly. Footprint 23" wide x 32" deep.
- Dolly priced separately.



Model # 10611



# OFFICE SEATING

Nabu™ Chair – fully upholstered mesh back Designer – BangDesign

— US Only —

Model Number	Seat H"	Arm H"	W"	D"	H"	Fabric Yds.	Leather Sq.Ft.	COM	COL	Neather	Verde	Grano	Cremoso	Knoll Textiles										
														1	2	3	4							
<b>NABU™ CHAIR WITH CANTILEVER ARMS</b>																								
	10621	17½-21	25½-29	23½	25½	35-38½	¾	9	upholstered seat with fully upholstered mesh back						1,200	1,245	1,255	1,385	1,445	1,485	1,275	1,340	1,410	1,485
	10622	17½-21	25½-29	23½	25½	35-38½			mesh seat with fully upholstered mesh back						1,215									
<b>NABU™ CHAIR WITH ADJUSTABLE ARMS</b>																								
	10629	17½-21	24½-28	24½	25½	35-38½	¾	9	upholstered seat with fully upholstered mesh back						1,230	1,275	1,285	1,385	1,470	1,505	1,300	1,365	1,435	1,510
	10630	17½-21	24½-28	24½	25½	35-38½			mesh seat with fully upholstered mesh back						1,250									
<b>NABU™ CHAIR ARMLESS</b>																								
	10623	17½-21		20	25½	35-38½	¾	9	upholstered seat with fully upholstered mesh back						1,105	1,150	1,175	1,305	1,355	1,400	1,185	1,245	1,315	1,395
	10624	17½-21		20	25½	35-38½			mesh seat with fully upholstered mesh back						1,130									

**NOTE:**

- Teller Stool (height: 43" - 53") add "T" at the end of model # with an upcharge of \$200 list per chair.

**Standard features:**

- Seat available in 29 solid mesh colors. Back available in 34 contrasting mesh stripe. Back mesh has a horizontal stripe pattern as standard created by the strong elastomer fiber woven in the mesh.
- Cushions are molded foam with 25% soy foam content
- Spring loaded pivot action provides a rocking motion 6 degrees back and 3 degrees forward.
- Knee tilt action with tension control and 4 position back lock available for an upcharge of \$85 list
- Swivel base is black as standard; add \$70.00 list for polished aluminum with chrome casters
- Tubular steel leg or sled base is standard silver powder coat
- Back frame and arms are black as standard.
- Models 10605 through 10608 are stachable - 6 high on floor and 10 high on dolly. Footprint 23" wide x 32" deep.
- Dolly priced separately.

Model # 10629



# OFFICE SEATING

Nienkämper NOW® Chair Designer - Mark Müller



Fixed Aluminum Arm Supports – Polished Finish  
(Available in Black Paint)



Multifunctional Armrest

## Multifunctional Arm Adjustments



Depth Adjustment  
• 5 Positions  
• 2" Range of Motion



Height Adjustment  
• 12 Positions  
• 4 3/8" Range of Motion



Swivel Adjustment  
• Left Swivel = 15°  
• Right Swivel = 15°



Width Adjustment  
• 3 Positions  
• Interior Arm Clearance= 18 1/2" to 20 3/4"  
(Can be increased up to 20 1/2" to 22 3/4")



Black Glides (Plastic)  
Available with Self-Return Base



Chrome Glides  
Available with Self-Return Base



75mm Black Plastic Casters  
Also available with soft-wheel

















75mm Casters  
(Chrome Centre Strip)  
Also available with soft wheel, or  
Electrical Static Discharge version



# OFFICE SEATING

Nienkämper NOW® Chair Designer - Mark Müller

— US Only —

Model Number	Seat H"	Arm H"	W"	D"	H"	Fabric Yds.	Leather Sq. Ft.	COM	COL	Neather	Verde	Grano	Cremoso	Knoll Textiles			
														1	2	3	4
<b>FULLY UPHOLSTERED</b>																	
Pneumatic Height Adjustment on Casters																	
	<b>13050</b>	Black Painted Arm Supports, Black Plastic Base, Black Casters															
	18-21	24½-27½	26	25	36½-39½	1¼	28	1,565	1,600	1,735	2,330	2,575	2,675	1,735	1,875	2,045	2,220
	<b>13052</b>	Black Painted Arm Supports, Polished Alum. Base, Chrome Casters															
	18-21	24½-27½	26	25	36½-39½	1¼	28	<b>1,745</b>	<b>1,785</b>	<b>2,075</b>	<b>2,505</b>	<b>2,760</b>	<b>2,855</b>	<b>1,920</b>	<b>2,060</b>	<b>2,230</b>	<b>2,395</b>
	<b>13024</b>	Polished Arm Supports, Black Plastic Base, Black Casters															
	18-21	24½-27½	26	25	36½-39½	1¼	28	1,635	1,675	1,810	2,395	2,645	2,730	1,810	1,955	2,125	2,290
	<b>13022</b>	Polished Arm Supports, Polished Alum. Base, Chrome Casters															
	18-21	24½-27½	26	25	36½-39½	1¼	28	<b>1,815</b>	<b>1,850</b>	<b>1,985</b>	<b>2,575</b>	<b>2,830</b>	<b>2,920</b>	<b>1,980</b>	<b>2,135</b>	<b>2,295</b>	<b>2,465</b>
	<b>13058</b>	Multifunctional Armrests, Black Plastic Base, Black Casters															
	18-21	24½-27½	27½	25	36½-39½	1¼	28	1,565	1,600	1,740	2,330	2,575	2,675	1,735	1,875	2,045	2,220
	<b>13060</b>	Multifunctional Armrests, Polished Alum. Base, Chrome Casters															
	18-21	24½-27½	27½	25	36½-39½	1¼	28	<b>1,745</b>	<b>1,785</b>	<b>1,925</b>	<b>2,505</b>	<b>2,760</b>	<b>2,855</b>	<b>1,920</b>	<b>2,060</b>	<b>2,230</b>	<b>2,395</b>
Pneumatic Height Adjustment on Glides																	
	<b>13062</b>	Black Painted Arm Supports, Black Plastic Base, Black Glides															
	18-21	24½-27½	26	25	36½-39½	1¼	28	1,525	1,555	1,695	2,275	2,530	2,615	1,695	1,840	2,010	2,175
	<b>13064</b>	Black Painted Arm Supports, Polished Alum. Base, Chrome Glides															
	18-21	24½-27½	26	25	36½-39½	1¼	28	<b>1,665</b>	<b>1,705</b>	<b>1,830</b>	<b>2,415</b>	<b>2,680</b>	<b>2,770</b>	<b>1,835</b>	<b>1,980</b>	<b>2,150</b>	<b>2,320</b>
	<b>13028</b>	Polished Arm Supports, Black Plastic Base, Black Glides															
	18-21	24½-27½	26	25	36½-39½	1¼	28	1,590	1,630	1,755	2,350	2,600	2,690	1,755	1,910	2,065	2,240
	<b>13027</b>	Polished Arm Supports, Polished Alum. Base, Chrome Glides															
	18-21	24½-27½	26	25	36½-39½	1¼	28	<b>1,735</b>	<b>1,760</b>	<b>1,910</b>	<b>2,490</b>	<b>2,750</b>	<b>2,835</b>	<b>1,910</b>	<b>2,050</b>	<b>2,220</b>	<b>2,385</b>
	<b>13070</b>	Multifunctional Armrests, Black Plastic Base, Black Glides															
	18-21	24½-27½	27½	25	36½-39½	1¼	28	1,525	1,555	1,695	2,275	2,530	2,615	1,695	1,840	2,010	2,175
	<b>13072</b>	Multifunctional Armrests, Polished Alum. Base, Chrome Glides															
	18-21	24½-27½	27½	25	36½-39½	1¼	28	<b>1,665</b>	<b>1,705</b>	<b>1,840</b>	<b>2,415</b>	<b>2,680</b>	<b>2,770</b>	<b>1,835</b>	<b>1,980</b>	<b>2,150</b>	<b>2,320</b>
Self-Return Jury Base with Pneumatic Height Adjustment																	
	<b>13074</b>	Black Painted Arm Supports, Black Aluminum Jury Base															
	18-22	24½-27½	26	25	36½-40½	1¼	28	1,720	1,805	1,860	2,415	2,615	2,730	1,885	2,035	2,195	2,370
	<b>13076</b>	Polished Painted Arm Supports, Black Aluminum Jury Base															
	18-22	24½-27½	26	25	36½-40½	1¼	28	<b>1,755</b>	<b>1,845</b>	<b>1,920</b>	<b>2,465</b>	<b>2,695</b>	<b>2,780</b>	<b>1,930</b>	<b>2,070</b>	<b>2,240</b>	<b>2,405</b>
	<b>13078</b>	Multifunctional Armrest, Black Aluminum Jury Base															
	18-22	24½-27½	27½	25	36½-40½	1¼	28	1,730	1,810	1,865	2,415	2,670	2,755	1,900	2,045	2,205	2,380

**Nienkämper NOW chair passes CAL 133 certified for an upcharge of \$305 list per chair. Certification applies to Nienkämper leathers and fabrics that have a minimum of 50% natural fibre content. COM's and COL's are subject to approval. Add the extension "-CAL" to the model number when ordering.**

The Nienkämper NOW® Chair brings Nienkämper's renowned fine upholstery and contemporary aesthetics to the conference-room chair. Height, back and tilt controls, firm lumbar support and a contoured back ensure a comfortable, ergonomic sitting experience. Top stitching on the edges, a distinctive Y detail on the back and a tuck on the seat and back emphasize the chair's crisp, tailored elegance.

#### Standard Features:

- Locking tilt with return safety function
- Pneumatic height adjustment
- Synchronized seat-and-back recline
- Tilt tension control
- Top-stitch detail on seat and back covers
- Jury base for auditorium seating
- Large 75mm, unhooded, hard wheel casters (for soft flooring)
- Chrome (zinc) or black (plastic) glides
- 26" diameter five-star base

Suffix	Optional Features:	
"A"	• Armless (remove painted arm supports)	(deduct \$150 list)
"B"	• Verde/Terraverde, Grano or Cremoso leather upholstered arm pads (for painted or polished arm supports) - plus additional 3 sq.ft. of COL	(add \$160 list)
"C"	• Verde/Terraverde, Grano or Cremoso leather upholstered arm pads & panels (remove painted arm supports) - plus additional 11 sq.ft. of COL	(add \$490 list)
"D"	• Contrast stitching (leather covers only)	(no upcharge)
"CAL"	• CAL 133 Certified applies to leather & fabric that has a minimum 50% natural fibre content. COM & COL subject to approval.	(add \$290 list)
<b>Caster Chair Options:</b>		
"E"	• Soft wheel caster (for hard floors); Black	(add \$75 list)
"F"	• Soft wheel caster (for hard floors); Chrome	(add \$55 list)
"G"	• Hard wheel Electrical Static Discharge (ESD) caster; Chrome (for soft flooring)	(add \$100 list)
"H"	• Fixed-height cylinder (no height adjustment, with swivel)	(no upcharge)
<b>Glide Chair Options:</b>		
"I"	• Self-Return Base with Pneumatic Height Adjustment	(add \$65 list)

# OFFICE SEATING

Nienkämper NOW® Chair – Slim Profile Back Designer - Mark Müller

— US Only —

Model Number	Seat H"	Arm H"	W"	D"	H"	Fabric Yds.	Leather Sq. Ft.	COM	COL	Neather	Verde	Grano	Cremoso	Knoll Textiles			
														1	2	3	4

## PILLOW BACK

Pneumatic Height Adjustment on Casters



<b>13110</b> Black Painted Arm Supports, Black Plastic Base, Black Casters	18-21	24½-27½	26	24	37½-40½	1¾	22	<b>1,950</b>	<b>2,015</b>	<b>2,110</b>	<b>2,555</b>	<b>2,755</b>	<b>2,815</b>	<b>2,125</b>	<b>2,265</b>	<b>2,430</b>	<b>2,600</b>
<b>13112</b> Black Painted Arm Supports, Polished Alum. Base, Chrome Casters	18-21	24½-27½	26	24	37½-40½	1¾	22	2,135	2,190	2,275	2,725	2,930	3,005	2,300	2,450	2,610	2,785
<b>13114</b> Polished Arm Supports, Black Plastic Base, Black Casters	18-21	24½-27½	26	24	37½-40½	1¾	22	<b>2,020</b>	<b>2,075</b>	<b>2,175</b>	<b>2,610</b>	<b>2,815</b>	<b>2,890</b>	<b>2,185</b>	<b>2,340</b>	<b>2,500</b>	<b>2,675</b>
<b>13116</b> Polished Arm Supports, Polished Alum. Base, Chrome Casters	18-21	24½-27½	26	24	37½-40½	1¾	22	2,195	2,260	2,350	2,795	3,005	3,070	2,370	2,515	2,685	2,855
<b>13118</b> Multifunctional Armrests, Black Plastic Base, Black Casters	18-21	24½-27½	27½	24	37½-40½	1¾	10	<b>1,950</b>	<b>2,015</b>	<b>2,110</b>	<b>2,555</b>	<b>2,755</b>	<b>2,815</b>	<b>2,125</b>	<b>2,265</b>	<b>2,430</b>	<b>2,600</b>
<b>13120</b> Multifunctional Armrests, Polished Alum. Base, Chrome Casters	18-21	24½-27½	27½	24	37½-40½	1¾	10	2,135	2,190	2,275	2,725	2,930	3,005	2,300	2,450	2,610	2,785

Pneumatic Height Adjustment on Glides



<b>13122</b> Black Painted Arm Supports, Black Plastic Base, Black Glides	18-21	24½-27½	26	24	37½-40½	1¾	22	<b>1,915</b>	<b>1,965</b>	<b>2,050</b>	<b>2,495</b>	<b>2,700</b>	<b>2,775</b>	<b>2,075</b>	<b>2,230</b>	<b>2,390</b>	<b>2,565</b>
<b>13124</b> Black Painted Arm Supports, Polished Alum. Base, Chrome Glides	18-21	24½-27½	26	24	37½-40½	1¾	22	2,045	2,115	2,195	2,645	2,855	2,920	2,220	2,365	2,530	2,700
<b>13126</b> Polished Arm Supports, Black Plastic Base, Black Glides	18-21	24½-27½	26	24	37½-40½	1¾	22	<b>1,970</b>	<b>2,035</b>	<b>2,125</b>	<b>2,570</b>	<b>2,775</b>	<b>2,845</b>	<b>2,145</b>	<b>2,290</b>	<b>2,455</b>	<b>2,620</b>
<b>13128</b> Polished Arm Supports, Polished Alum. Base, Chrome Glides	18-21	24½-27½	26	24	37½-40½	1¾	22	2,120	2,180	2,265	2,710	2,920	2,980	2,285	2,430	2,595	2,770
<b>13130</b> Multifunctional Armrests, Black Plastic Base, Black Glides	18-21	24½-27½	27½	24	37½-40½	1¾	10	<b>1,915</b>	<b>1,965</b>	<b>2,050</b>	<b>2,495</b>	<b>2,700</b>	<b>2,775</b>	<b>2,075</b>	<b>2,230</b>	<b>2,390</b>	<b>2,565</b>
<b>13132</b> Multifunctional Armrests, Polished Alum. Base, Chrome Glides	18-21	24½-27½	27½	24	37½-40½	1¾	10	2,045	2,115	2,195	2,645	2,855	2,920	2,220	2,365	2,530	2,700

Self-Return Jury Base with Pneumatic Height Adjustment



<b>13134</b> Black Painted Arm Supports, Black Aluminum Jury Base	18-22	24½-28½	26	24	37½-41½	1¾	22	<b>2,070</b>	<b>2,175</b>	<b>2,230</b>	<b>2,780</b>	<b>3,015</b>	<b>3,100</b>	<b>2,245</b>	<b>2,390</b>	<b>2,560</b>	<b>2,725</b>
<b>13136</b> Polished Arm Supports, Black Aluminum Jury Base	18-22	24½-28½	26	24	37½-41½	1¾	22	2,120	2,230	2,265	2,830	3,065	3,140	2,285	2,430	2,595	2,770
<b>13138</b> Multifunctional Armrest, Black Aluminum Jury Base	18-22	24½-28½	26	24	37½-41½	1¾	22	<b>2,045</b>	<b>2,145</b>	<b>2,195</b>	<b>2,755</b>	<b>2,990</b>	<b>3,070</b>	<b>2,220</b>	<b>2,365</b>	<b>2,530</b>	<b>2,700</b>

The Nienkämper NOW® Chair brings Nienkämper's renowned fine upholstery and contemporary aesthetics to the conference-room chair. Height, back and tilt controls, firm lumbar support and a contoured back ensure a comfortable, ergonomic sitting experience.

### Standard Features:

- Locking tilt with return safety function
- Pneumatic height adjustment
- Synchronized seat-and-back recline
- Tilt tension control
- Top-stitch detail on seat cover
- Jury base for auditorium seating
- Large 75mm, unhooded, hard wheel casters (for soft flooring)
- Chrome (zinc) or black (plastic) glides
- 26" diameter five-star base

Suffix	Optional Features:	
"A"	• Armless (remove painted arm supports)	(deduct \$160 list)
"B"	• Verde/Terraverde, Grano or Cremoso leather upholstered arm pads (for painted or polished arm supports) - plus additional 3 sq.ft. of COL	(add \$170 list)
"C"	• Verde/Terraverde, Grano or Cremoso leather upholstered arm pads & panels (remove painted arm supports) - plus additional 11 sq.ft. of COL	(add \$515 list)
"D"	• Contrast stitching (leather covers only)	(no upcharge)
"CAL"	• CAL 133 Certified applies to leather & fabric that has a minimum 50% natural fibre content. COM & COL subject to approval.	(add \$305 list)
<b>Caster Chair Options:</b>		
"E"	• Soft wheel caster (for hard floors); Black	(add \$80 list)
"F"	• Soft wheel caster (for hard floors); Chrome	(add \$60 list)
"G"	• Hard wheel Electrical Static Discharge (ESD) caster; Chrome (for soft flooring)	(add \$105 list)
"H"	• Fixed-height cylinder (no height adjustment, with swivel)	(no upcharge)
<b>Glide Chair Options:</b>		
"I"	• Self-Return Base with Pneumatic Height Adjustment	(add \$70 list)

# OFFICE SEATING

Nienkämper NOW® Chair – Slim Profile Back Designer - Mark Müller

— US Only —

Model Number	Seat H"	Arm H"	W"	D"	H"	Fabric Yds.	Leather Sq. Ft.	COM	COL	Neather	Verde	Grano	Cremoso	Knoll Textiles								
														1	2	3	4					
<b>HORIZONTAL BACK</b>																						
Pneumatic Height Adjustment on Casters																						
	<b>13140</b>	Black Painted Arm Supports, Black Plastic Base, Black Casters																				
		18-21	24½-27½	26	24	37½-40½	1¾	22														
									<b>1,950</b>	<b>2,015</b>	<b>2,110</b>	<b>2,555</b>	<b>2,755</b>	<b>2,815</b>	<b>2,125</b>	<b>2,265</b>	<b>2,430</b>	<b>2,600</b>				
	<b>13142</b>	Black Painted Arm Supports, Polished Alum. Base, Chrome Casters																				
		18-21	24½-27½	26	24	37½-40½	1¾	22														
									2,135	2,190	2,275	2,725	2,930	3,005	2,300	2,450	2,610	2,785				
	<b>13144</b>	Polished Arm Supports, Black Plastic Base, Black Casters																				
		18-21	24½-27½	26	24	37½-40½	1¾	22														
									<b>2,020</b>	<b>2,075</b>	<b>2,175</b>	<b>2,610</b>	<b>2,815</b>	<b>2,890</b>	<b>2,185</b>	<b>2,340</b>	<b>2,500</b>	<b>2,675</b>				
	<b>13146</b>	Polished Arm Supports, Polished Alum. Base, Chrome Casters																				
	18-21	24½-27½	26	24	37½-40½	1¾	22															
								2,195	2,260	2,350	2,795	3,005	3,070	2,370	2,515	2,685	2,855					
<b>13148</b>	Multifunctional Armrests, Black Plastic Base, Black Casters																					
	18-21	24½-27½	27½	24	37½-40½	1¾	10															
								<b>1,950</b>	<b>2,015</b>	<b>2,110</b>	<b>2,555</b>	<b>2,755</b>	<b>2,815</b>	<b>2,125</b>	<b>2,265</b>	<b>2,430</b>	<b>2,600</b>					
<b>13150</b>	Multifunctional Armrests, Polished Alum. Base, Chrome Casters																					
	18-21	24½-27½	27½	24	37½-40½	1¾	10															
								2,135	2,190	2,275	2,725	2,930	3,005	2,300	2,450	2,610	2,785					

Pneumatic Height Adjustment on Glides



	<b>13172</b>	Black Painted Arm Supports, Black Plastic Base, Black Glides																				
		18-21	24½-27½	26	24	37½-40½	1¾	22														
									<b>1,915</b>	<b>1,965</b>	<b>2,050</b>	<b>2,495</b>	<b>2,700</b>	<b>2,775</b>	<b>2,075</b>	<b>2,230</b>	<b>2,390</b>	<b>2,565</b>				
	<b>13174</b>	Black Painted Arm Supports, Polished Alum. Base, Chrome Glides																				
		18-21	24½-27½	26	24	37½-40½	1¾	22														
									2,045	2,115	2,195	2,645	2,855	2,920	2,220	2,365	2,530	2,700				
	<b>13176</b>	Polished Arm Supports, Black Plastic Base, Black Glides																				
		18-21	24½-27½	26	24	37½-40½	1¾	22														
									<b>1,970</b>	<b>2,035</b>	<b>2,125</b>	<b>2,570</b>	<b>2,775</b>	<b>2,845</b>	<b>2,145</b>	<b>2,290</b>	<b>2,455</b>	<b>2,620</b>				
	<b>13178</b>	Polished Arm Supports, Polished Alum. Base, Chrome Glides																				
	18-21	24½-27½	26	24	37½-40½	1¾	22															
								2,120	2,180	2,265	2,710	2,920	2,980	2,285	2,430	2,595	2,770					
<b>13180</b>	Multifunctional Armrests, Black Plastic Base, Black Glides																					
	18-21	24½-27½	27½	24	37½-40½	1¾	10															
								<b>1,915</b>	<b>1,965</b>	<b>2,050</b>	<b>2,495</b>	<b>2,700</b>	<b>2,775</b>	<b>2,075</b>	<b>2,230</b>	<b>2,390</b>	<b>2,565</b>					
<b>13182</b>	Multifunctional Armrests, Polished Alum. Base, Chrome Glides																					
	18-21	24½-27½	27½	24	37½-40½	1¾	10															
								2,045	2,115	2,195	2,645	2,855	2,920	2,220	2,365	2,530	2,700					

Self-Return Jury Base with Pneumatic Height Adjustment



	<b>13184</b>	Black Painted Arm Supports, Black Plastic Base, Black Casters																				
		18-22	24½-28½	26	24	37½-41½	1¾	22														
									<b>2,070</b>	<b>2,175</b>	<b>2,230</b>	<b>2,780</b>	<b>3,015</b>	<b>3,100</b>	<b>2,245</b>	<b>2,390</b>	<b>2,560</b>	<b>2,725</b>				
	<b>13186</b>	Black Painted Arm Supports, Polished Alum. Base, Chrome Casters																				
		18-22	24½-28½	26	24	37½-41½	1¾	22														
									2,120	2,230	2,265	2,830	3,065	3,140	2,285	2,430	2,595	2,770				
<b>13188</b>	Polished Arm Supports, Black Plastic Base, Black Casters																					
	18-22	24½-28½	26	24	37½-41½	1¾	22															
								<b>2,045</b>	<b>2,145</b>	<b>2,195</b>	<b>2,755</b>	<b>2,990</b>	<b>3,070</b>	<b>2,220</b>	<b>2,365</b>	<b>2,530</b>	<b>2,700</b>					

The Nienkämper NOW® Chair brings Nienkämper's renowned fine upholstery and contemporary aesthetics to the conference-room chair. Height, back and tilt controls, firm lumbar support and a contoured back ensure a comfortable, ergonomic sitting experience.

### Standard Features:

- Locking tilt with return safety function
- Pneumatic height adjustment
- Synchronized seat-and-back recline
- Tilt tension control
- Top-stitch detail on seat cover
- Jury base for auditorium seating
- Large 75mm, unhooded, hard wheel casters (for soft flooring)
- Chrome (zinc) or black (plastic) glides
- 26" diameter five-star base

### Suffix Optional Features:

<b>"A"</b>	• Armless (remove painted arm supports)	(deduct \$160 list)
<b>"B"</b>	• Verde/Terraverde, Grano or Cremoso leather upholstered arm pads (for painted or polished arm supports) - plus additional 3 sq.ft. of COL	(add \$170 list)
<b>"C"</b>	• Verde/Terraverde, Grano or Cremoso leather upholstered arm pads & panels (remove painted arm supports) - plus additional 11 sq.ft. of COL	(add \$515 list)
<b>"D"</b>	• Contrast stitching (leather covers only)	(no upcharge)
<b>"CAL"</b>	• CAL 133 Certified applies to leather & fabric that has a minimum fibre content. COM & COL subject to approval.	50% natural (add \$305 list)
<b>Caster Chair Options:</b>		
<b>"E"</b>	• Soft wheel caster (for hard floors); Black	(add \$80 list)
<b>"F"</b>	• Soft wheel caster (for hard floors); Chrome	(add \$60 list)
<b>"G"</b>	• Hard wheel Electrical Static Discharge (ESD) caster; Chrome (for soft flooring)	(add \$105 list)
<b>"H"</b>	• Fixed-height cylinder (no height adjustment, with swivel)	(no upcharge)
<b>Glide Chair Options:</b>		
<b>"I"</b>	• Self-Return Base with Pneumatic Height Adjustment	(add \$70 list)

# OFFICE SEATING

Nienkämper NOW® Chair – Mesh Back Designer - Mark Müller

— US Only —

Model Number	Seat H"	Arm H"	W"	D"	H"	Fabric Yds.	Leather Sq. Ft.	COM	COL	Mesh	Neather	Verde	Grano	Cremoso	Knoll Textiles			
															1	2	3	4
<b>STANDARD MESHBACK</b>																		
Pneumatic Height Adjustment on Casters																		
	<b>13080</b>	Black Painted Arm Supports, Black Plastic Base, Black Casters																
	18-21	24½-27½	26	24	37½-40½	1¾	10	<b>1,745</b>	<b>1,755</b>	<b>1,650</b>	<b>1,820</b>	<b>2,020</b>	<b>2,115</b>	<b>2,145</b>	<b>1,920</b>	<b>2,060</b>	<b>2,230</b>	<b>2,395</b>
	<b>13082</b>	Black Painted Arm Supports, Polished Alum. Base, Chrome Casters																
	18-21	24½-27½	26	24	37½-40½	1¾	10	1,930	1,945	1,840	2,010	2,195	2,295	2,330	2,095	2,245	2,405	2,580
	<b>13084</b>	Polished Arm Supports, Black Plastic Base, Black Casters																
	18-21	24½-27½	26	24	37½-40½	1¾	10	<b>1,815</b>	<b>1,830</b>	<b>1,730</b>	<b>1,870</b>	<b>2,090</b>	<b>2,180</b>	<b>2,205</b>	<b>1,980</b>	<b>2,135</b>	<b>2,295</b>	<b>2,465</b>
	<b>13086</b>	Polished Arm Supports, Polished Alum. Base, Chrome Casters																
	18-21	24½-27½	26	24	37½-40½	1¾	10	1,995	2,015	1,915	2,070	2,265	2,370	2,395	2,165	2,310	2,480	2,645
	<b>13088</b>	Multifunctional Armrests, Black Plastic Base, Black Casters																
	18-21	24½-27½	27½	24	37½-40½	1¾	10	<b>1,745</b>	<b>1,755</b>	<b>1,650</b>	<b>1,815</b>	<b>2,020</b>	<b>2,115</b>	<b>2,145</b>	<b>1,920</b>	<b>2,060</b>	<b>2,230</b>	<b>2,395</b>
	<b>13090</b>	Multifunctional Armrests, Polished Alum. Base, Chrome Casters																
	18-21	24½-27½	27½	24	37½-40½	1¾	10	1,930	1,945	1,840	1,995	2,195	2,295	2,330	2,095	2,245	2,405	2,580

Pneumatic Height Adjustment on Glides

	<b>13092</b>	Black Painted Arm Supports, Black Plastic Base, Black Glides															
	18-21	24½-27½	26	24	37½-40½	1¾	10	<b>1,705</b>	<b>1,720</b>	<b>1,615</b>	<b>1,760</b>	<b>1,970</b>	<b>2,055</b>	<b>2,110</b>	<b>1,870</b>	<b>2,025</b>	<b>2,185</b>
	<b>13094</b>	Black Painted Arm Supports, Polished Alum. Base, Chrome Glides															
	18-21	24½-27½	26	24	37½-40½	1¾	10	1,845	1,855	1,750	1,925	2,120	2,200	2,245	2,020	2,165	2,335
	<b>13096</b>	Polished Arm Supports, Black Plastic Base, Black Glides															
	18-21	24½-27½	26	24	37½-40½	1¾	10	<b>1,760</b>	<b>1,785</b>	<b>1,680</b>	<b>1,845</b>	<b>2,040</b>	<b>2,135</b>	<b>2,175</b>	<b>1,935</b>	<b>2,075</b>	<b>2,245</b>
	<b>13098</b>	Polished Arm Supports, Polished Alum. Base, Chrome Glides															
	18-21	24½-27½	26	24	37½-40½	1¾	10	1,920	1,930	1,820	1,985	2,185	2,270	2,310	2,080	2,235	2,395
	<b>13100</b>	Multifunctional Armrests, Black Plastic Base, Black Glides															
	18-21	24½-27½	27½	24	37½-40½	1¾	10	<b>1,705</b>	<b>1,720</b>	<b>1,615</b>	<b>1,775</b>	<b>1,970</b>	<b>2,055</b>	<b>2,110</b>	<b>1,870</b>	<b>2,025</b>	<b>2,185</b>
	<b>13102</b>	Multifunctional Armrests, Polished Alum. Base, Chrome Glides															
	18-21	24½-27½	27½	24	37½-40½	1¾	10	1,845	1,855	1,750	1,920	2,120	2,200	2,245	2,020	2,165	2,335

Self-Return Jury Base with Pneumatic Height Adjustment

	<b>13104</b>	Black Painted Arm Supports, Black Aluminum Jury Base															
	18-21	24½-28½	26	24	37½-41½	1¾	10	<b>1,860</b>	<b>1,955</b>	<b>1,775</b>	<b>1,955</b>	<b>2,270</b>	<b>2,410</b>	<b>2,465</b>	<b>2,035</b>	<b>2,180</b>	<b>2,350</b>
	<b>13106</b>	Polished Arm Supports, Black Aluminum Jury Base															
	18-21	24½-28½	26	24	37½-41½	1¾	10	1,935	2,035	1,845	2,030	2,350	2,480	2,530	2,110	2,250	2,410
	<b>13108</b>	Multifunctional Armrest, Black Aluminum Jury Base															
	18-21	24½-28½	27½	24	37½-41½	1¾	10	<b>1,845</b>	<b>1,935</b>	<b>1,750</b>	<b>1,935</b>	<b>2,260</b>	<b>2,390</b>	<b>2,445</b>	<b>2,020</b>	<b>2,165</b>	<b>2,335</b>

The Nienkämper NOW® Chair brings Nienkämper's renowned fine upholstery and contemporary aesthetics to the conference-room chair. Height, back and tilt controls, firm lumbar support and a contoured back ensure a comfortable, ergonomic sitting experience.

### Standard Features:

- Locking tilt with return safety function
- Pneumatic height adjustment
- Synchronized seat-and-back recline
- Tilt tension control
- 30 optional mesh colors
- Top-stitch detail on seat cover
- Polyamide mesh back cover
- Jury base for auditorium seating
- Large 75mm, unhooded, hard wheel casters (for soft flooring)
- Chrome (zinc) or black (plastic) glides
- 26" diameter five-star base

### Mesh Seat Features:



- When the knitted Seat & Back option is selected, the seat is knitted in one complete piece with no stitching.
- The Seat & Back can be coordinated in 30 standard colors or contrasted – example: Black Seat and Colored Back

Suffix	Optional Features:
"A"	• Armless (remove painted arm supports) (deduct \$160 list)
"B"	• Verde/Terraverde, Grano or Cremoso leather upholstered arm pads (for painted or polished arm supports) (add \$170 list) - plus additional 3 sq.ft. of COL
"C"	• Verde/Terraverde, Grano or Cremoso leather upholstered arm pads & panels (remove painted arm supports) (add \$515 list) - plus additional 11 sq.ft. of COL
"D"	• Contrast stitching (leather covers only) (no upcharge)
"CAL"	• CAL 133 Certified applies to leather & fabric that has a minimum 50% natural fibre content. COM & COL subject to approval. (add \$305 list)
<b>Caster Chair Options:</b>	
"E"	• Soft wheel caster (for hard floors); Black (add \$80 list)
"F"	• Soft wheel caster (for hard floors); Chrome (add \$60 list)
"G"	• Hard wheel Electrical Static Discharge (ESD) caster; Chrome (for soft flooring) (add \$105 list)
"H"	• Fixed-height cylinder (no height adjustment, with swivel) (no upcharge)
<b>Glide Chair Options:</b>	
"I"	• Self-Return Base with Pneumatic Height Adjustment (add \$70 list)



# OFFICE SEATING

Nienkämper NOW® Chair – Mesh Back Designer - Mark Müller



— US Only —

Model Number	Seat H"	Arm H"	W"	D"	H"	Fabric Yds.	Leather Sq. Ft.	COM	COL	Mesh	Neather	Verde	Grano	Cremoso	Knoll Textiles					
															1	2	3	4		
<b>HORIZONTAL MESH BACK</b>																				
Pneumatic Height Adjustment on Casters																				
	<b>13080H</b>	Black Painted Arm Supports, Black Plastic Base, Black Casters	18-21	24½-27½	26	24	37½-40½	¾	10	<b>1,745</b>	<b>1,755</b>	<b>1,650</b>	<b>1,820</b>	<b>2,020</b>	<b>2,115</b>	<b>2,145</b>	<b>1,820</b>	<b>1,875</b>	<b>1,955</b>	<b>2,030</b>
	<b>13082H</b>	Black Painted Arm Supports, Polished Alum. Base, Chrome Casters	18-21	24½-27½	26	24	37½-40½	¾	10	1,930	1,945	1,840	2,010	2,195	2,295	2,330	2,005	2,060	2,140	2,205
	<b>13084H</b>	Polished Arm Supports, Black Plastic Base, Black Casters	18-21	24½-27½	26	24	37½-40½	¾	10	<b>1,815</b>	<b>1,830</b>	<b>1,730</b>	<b>1,870</b>	<b>2,090</b>	<b>2,180</b>	<b>2,205</b>	<b>1,885</b>	<b>1,950</b>	<b>2,025</b>	<b>2,095</b>
	<b>13086H</b>	Polished Arm Supports, Polished Alum. Base, Chrome Casters	18-21	24½-27½	26	24	37½-40½	¾	10	1,995	2,015	1,915	2,070	2,265	2,370	2,395	2,065	2,135	2,200	2,275
	<b>13088H</b>	Multifunctional Armrests, Black Plastic Base, Black Casters	18-21	24½-27½	27½	24	37½-40½	¾	10	<b>1,745</b>	<b>1,755</b>	<b>1,650</b>	<b>1,815</b>	<b>2,020</b>	<b>2,115</b>	<b>2,145</b>	<b>1,820</b>	<b>1,875</b>	<b>1,955</b>	<b>2,030</b>
	<b>13090H</b>	Multifunctional Armrests, Polished Alum. Base, Chrome Casters	18-21	24½-27½	27½	24	37½-40½	¾	10	1,930	1,945	1,840	1,995	2,195	2,295	2,330	2,005	2,060	2,140	2,205

Pneumatic Height Adjustment on Glides

	<b>13092H</b>	Black Painted Arm Supports, Black Plastic Base, Black Glides	18-21	24½-27½	26	24	37½-40½	¾	10	<b>1,705</b>	<b>1,720</b>	<b>1,615</b>	<b>1,760</b>	<b>1,970</b>	<b>2,055</b>	<b>2,110</b>	<b>1,780</b>	<b>1,840</b>	<b>1,920</b>	<b>1,985</b>
	<b>13094H</b>	Black Painted Arm Supports, Polished Alum. Base, Chrome Glides	18-21	24½-27½	26	24	37½-40½	¾	10	1,845	1,855	1,750	1,925	2,120	2,200	2,245	1,925	1,980	2,055	2,135
	<b>13096H</b>	Polished Arm Supports, Black Plastic Base, Black Glides	18-21	24½-27½	26	24	37½-40½	¾	10	<b>1,760</b>	<b>1,785</b>	<b>1,680</b>	<b>1,845</b>	<b>2,040</b>	<b>2,135</b>	<b>2,175</b>	<b>1,835</b>	<b>1,900</b>	<b>1,970</b>	<b>2,045</b>
	<b>13098H</b>	Polished Arm Supports, Polished Alum. Base, Chrome Glides	18-21	24½-27½	26	24	37½-40½	¾	10	1,920	1,930	1,820	1,985	2,185	2,270	2,310	1,985	2,050	2,130	2,195
	<b>13100H</b>	Multifunctional Armrests, Black Plastic Base, Black Glides	18-21	24½-27½	27½	24	37½-40½	¾	10	<b>1,705</b>	<b>1,720</b>	<b>1,615</b>	<b>1,775</b>	<b>1,970</b>	<b>2,055</b>	<b>2,110</b>	<b>1,780</b>	<b>1,840</b>	<b>1,920</b>	<b>1,985</b>
	<b>13102H</b>	Multifunctional Armrests, Polished Alum. Base, Chrome Glides	18-21	24½-27½	27½	24	37½-40½	¾	10	1,845	1,855	1,750	1,920	2,120	2,200	2,245	1,925	1,980	2,055	2,135

Self-Return Jury Base with Pneumatic Height Adjustment

	<b>13104H</b>	Black Painted Arm Supports, Black Aluminum Jury Base	18-22	24½-28½	26	24	37½-41½	¾	10	<b>1,860</b>	<b>1,955</b>	<b>1,775</b>	<b>1,955</b>	<b>2,270</b>	<b>2,410</b>	<b>2,465</b>	<b>1,940</b>	<b>2,005</b>	<b>2,070</b>	<b>2,150</b>
	<b>13106H</b>	Polished Arm Supports, Black Aluminum Jury Base	18-22	24½-28½	26	24	37½-41½	¾	10	1,935	2,035	1,845	2,030	2,350	2,480	2,530	2,010	2,065	2,145	2,220
	<b>13108H</b>	Multifunctional Armrest, Black Aluminum Jury Base	18-22	24½-28½	27½	24	37½-41½	¾	10	<b>1,845</b>	<b>1,935</b>	<b>1,750</b>	<b>1,935</b>	<b>2,260</b>	<b>2,390</b>	<b>2,445</b>	<b>1,925</b>	<b>1,980</b>	<b>2,055</b>	<b>2,135</b>

The Nienkämper NOW® Chair brings Nienkämper's renowned fine upholstery and contemporary aesthetics to the conference-room chair. Height, back and tilt controls, firm lumbar support and a contoured back ensure a comfortable, ergonomic sitting experience.

### Standard Features:

- Locking tilt with return safety function
- Pneumatic height adjustment
- Synchronized seat-and-back recline
- Tilt tension control
- 30 optional mesh colors
- Top-stitch detail on seat cover
- Polyamide mesh back cover
- Jury base for auditorium seating
- Large 75mm, unhooded, hard wheel casters (for soft flooring)
- Chrome (zinc) or black (plastic) glides
- 26" diameter five-star base

### Mesh Seat Features:

- When the knitted Seat & Back option is selected, the seat is knitted in one complete piece with no stitching.
- The Seat & Back can be coordinated in 30 standard colors or contrasted – example: Black Seat and Colored Back



### Suffix Optional Features:

<b>"A"</b>	• Armless (remove painted arm supports)	(deduct \$160 list)
<b>"B"</b>	• Verde/Terraverde, Grano or Cremoso leather upholstered arm pads (for painted or polished arm supports) - plus additional 3 sq.ft. of COL	(add \$170 list)
<b>"C"</b>	• Verde/Terraverde, Grano or Cremoso leather upholstered arm pads & panels (remove painted arm supports) - plus additional 11 sq.ft. of COL	(add \$515 list)
<b>"D"</b>	• Contrast stitching (leather covers only)	(no upcharge)
<b>"CAL"</b>	• CAL 133 Certified applies to leather & fabric that has a minimum 50% natural fibre content. COM & COL subject to approval.	(add \$305 list)
<b>Caster Chair Options:</b>		
<b>"E"</b>	• Soft wheel caster (for hard floors); Black	(add \$80 list)
<b>"F"</b>	• Soft wheel caster (for hard floors); Chrome	(add \$60 list)
<b>"G"</b>	• Hard wheel Electrical Static Discharge (ESD) caster; Chrome (for soft flooring)	(add \$105 list)
<b>"H"</b>	• Fixed-height cylinder (no height adjustment, with swivel)	(no upcharge)
<b>Glide Chair Options:</b>		
<b>"I"</b>	• Self-Return Base with Pneumatic Height Adjustment	(add \$70 list)



# OFFICE SEATING

Nienkämper NOW® Chair – Mesh Back Designer - Mark Müller



— US Only —

Model Number	Seat H"	Arm H"	W"	D"	H"	Fabric Yds.	Leather Sq.Ft.	COM	COL	Mesh	Neather	Verde	Grano	Cremoso	Knoll Textiles					
															1	2	3	4		
<b>BOX MESH BACK</b>																				
Pneumatic Height Adjustment on Casters																				
	<b>13080B</b>	Black Painted Arm Supports, Black Plastic Base, Black Casters	18-21	24½-27½	26	24	37½-40½	¾	10	<b>1,745</b>	<b>1,755</b>	<b>1,650</b>	<b>1,820</b>	<b>2,020</b>	<b>2,115</b>	<b>2,145</b>	<b>1,820</b>	<b>1,875</b>	<b>1,955</b>	<b>2,030</b>
	<b>13082B</b>	Black Painted Arm Supports, Polished Alum. Base, Chrome Casters	18-21	24½-27½	26	24	37½-40½	¾	10	1,930	1,945	1,840	2,010	2,195	2,295	2,330	2,005	2,060	2,140	2,205
	<b>13084B</b>	Polished Arm Supports, Black Plastic Base, Black Casters	18-21	24½-27½	26	24	37½-40½	¾	10	<b>1,815</b>	<b>1,830</b>	<b>1,730</b>	<b>1,870</b>	<b>2,090</b>	<b>2,180</b>	<b>2,205</b>	<b>1,885</b>	<b>1,950</b>	<b>2,025</b>	<b>2,095</b>
	<b>13086B</b>	Polished Arm Supports, Polished Alum. Base, Chrome Casters	18-21	24½-27½	26	24	37½-40½	¾	10	1,995	2,015	1,915	2,070	2,265	2,370	2,395	2,065	2,135	2,200	2,275
	<b>13088B</b>	Multifunctional Armrests, Black Plastic Base, Black Casters	18-21	24½-27½	27½	24	37½-40½	¾	10	<b>1,745</b>	<b>1,755</b>	<b>1,650</b>	<b>1,815</b>	<b>2,020</b>	<b>2,115</b>	<b>2,145</b>	<b>1,820</b>	<b>1,875</b>	<b>1,955</b>	<b>2,030</b>
	<b>13090B</b>	Multifunctional Armrests, Polished Alum. Base, Chrome Casters	18-21	24½-27½	27½	24	37½-40½	¾	10	1,930	1,945	1,840	1,995	2,195	2,295	2,330	2,005	2,060	2,140	2,205

Pneumatic Height Adjustment on Glides

	<b>13092B</b>	Black Painted Arm Supports, Black Plastic Base, Black Glides	18-21	24½-27½	26	24	37½-40½	¾	10	<b>1,705</b>	<b>1,720</b>	<b>1,615</b>	<b>1,760</b>	<b>1,970</b>	<b>2,055</b>	<b>2,110</b>	<b>1,780</b>	<b>1,840</b>	<b>1,920</b>	<b>1,985</b>
	<b>13094B</b>	Black Painted Arm Supports, Polished Alum. Base, Chrome Glides	18-21	24½-27½	26	24	37½-40½	¾	10	1,845	1,855	1,750	1,925	2,120	2,200	2,245	1,925	1,980	2,055	2,135
	<b>13096B</b>	Polished Arm Supports, Black Plastic Base, Black Glides	18-21	24½-27½	26	24	37½-40½	¾	10	<b>1,760</b>	<b>1,785</b>	<b>1,680</b>	<b>1,845</b>	<b>2,040</b>	<b>2,135</b>	<b>2,175</b>	<b>1,835</b>	<b>1,900</b>	<b>1,970</b>	<b>2,045</b>
	<b>13098B</b>	Polished Arm Supports, Polished Alum. Base, Chrome Glides	18-21	24½-27½	26	24	37½-40½	¾	10	1,920	1,930	1,820	1,985	2,185	2,270	2,310	1,985	2,050	2,130	2,195
	<b>13100B</b>	Multifunctional Armrests, Black Plastic Base, Black Glides	18-21	24½-27½	27½	24	37½-40½	¾	10	<b>1,705</b>	<b>1,720</b>	<b>1,615</b>	<b>1,775</b>	<b>1,970</b>	<b>2,055</b>	<b>2,110</b>	<b>1,780</b>	<b>1,840</b>	<b>1,920</b>	<b>1,985</b>
	<b>13102B</b>	Multifunctional Armrests, Polished Alum. Base, Chrome Glides	18-21	24½-27½	27½	24	37½-40½	¾	10	1,845	1,855	1,750	1,920	2,120	2,200	2,245	1,925	1,980	2,055	2,135

Self-Return Jury Base with Pneumatic Height Adjustment

	<b>13104B</b>	Black Painted Arm Supports, Black Aluminum Jury Base	18-22	24½-28½	26	24	37½-41½	¾	10	<b>1,860</b>	<b>1,955</b>	<b>1,775</b>	<b>1,955</b>	<b>2,270</b>	<b>2,410</b>	<b>2,465</b>	<b>1,940</b>	<b>2,005</b>	<b>2,070</b>	<b>2,150</b>
	<b>13106B</b>	Polished Arm Supports, Black Aluminum Jury Base	18-22	24½-28½	26	24	37½-41½	¾	10	1,935	2,035	1,845	2,030	2,350	2,480	2,530	2,010	2,065	2,145	2,220
	<b>13108B</b>	Multifunctional Armrest, Black Aluminum Jury Base	18-22	24½-28½	26	24	37½-41½	¾	10	<b>1,845</b>	<b>1,935</b>	<b>1,750</b>	<b>1,935</b>	<b>2,260</b>	<b>2,390</b>	<b>2,445</b>	<b>1,925</b>	<b>1,980</b>	<b>2,055</b>	<b>2,135</b>

The Nienkämper NOW® Chair brings Nienkämper's renowned fine upholstery and contemporary aesthetics to the conference-room chair. Height, back and tilt controls, firm lumbar support and a contoured back ensure a comfortable, ergonomic sitting experience.

### Standard Features:

- Locking tilt with return safety function
- Pneumatic height adjustment
- Synchronized seat-and-back recline
- Tilt tension control
- 30 optional mesh colors
- Top-stitch detail on seat cover
- Polyamide mesh back cover
- Jury base for auditorium seating
- Large 75mm, unhooded, hard wheel casters (for soft flooring)
- Chrome (zinc) or black (plastic) glides
- 26" diameter five-star base

### Mesh Seat Features:

- When the knitted Seat & Back option is selected, the seat is knitted in one complete piece with no stitching.
- The Seat & Back can be coordinated in 30 standard colors or contrasted – example: Black Seat and Colored Back

Suffix	Optional Features:	
"A"	• Armless (remove painted arm supports)	(deduct \$160 list)
"B"	• Verde/Terraverde, Grano or Cremoso leather upholstered arm pads (for painted or polished arm supports) - plus additional 3 sq.ft. of COL	(add \$170 list)
"C"	• Verde/Terraverde, Grano or Cremoso leather upholstered arm pads & panels (remove painted arm supports) - plus additional 11 sq.ft. of COL	(add \$515 list)
"D"	• Contrast stitching (leather covers only)	(no upcharge)
"CAL"	• CAL 133 Certified applies to leather & fabric that has a minimum 50% natural fibre content. COM & COL subject to approval.	(add \$305 list)
<b>Caster Chair Options:</b>		
"E"	• Soft wheel caster (for hard floors); Black	(add \$80 list)
"F"	• Soft wheel caster (for hard floors); Chrome	(add \$60 list)
"G"	• Hard wheel Electrical Static Discharge (ESD) caster; Chrome (for soft flooring)	(add \$105 list)
"H"	• Fixed-height cylinder (no height adjustment, with swivel)	(no upcharge)
<b>Glide Chair Options:</b>		
"I"	• Self-Return Base with Pneumatic Height Adjustment	(add \$70 list)

# OFFICE SEATING

Senator® Boardroom Designer – Nienkämper

— US Only —

Model Number	Seat H"	Arm				Fabric Yds.	Leather Sq. Ft.	COM	COL	Neather	Verde	Grano	Cremoso	Knoll Textiles				
		H"	W"	D"	H"									1	2	3	4	
<b>1464</b>	18½-21½	25	25	25	36													
<b>(Model #1)</b>	Urethane arm					1¼	22	<b>1,980</b>	<b>2,070</b>	<b>2,120</b>	<b>2,800</b>	<b>3,015</b>	<b>3,110</b>	<b>2,155</b>	<b>2,300</b>	<b>2,465</b>	<b>2,635</b>	
<b>(Model #9)</b>	Urethane arm with wrap					1½	24	2,190	2,305	2,350	3,140	3,375	3,475	2,340	2,465	2,605	2,755	
<b>(Model #2)</b>	Urethane arm with cap					1½	24	<b>2,190</b>	<b>2,305</b>	<b>2,350</b>	<b>3,140</b>	<b>3,375</b>	<b>3,475</b>	<b>2,340</b>	<b>2,465</b>	<b>2,605</b>	<b>2,755</b>	
<b>(Model #3)</b>	Urethane arm with cap and wrap					1¾	26	2,250	2,370	2,455	3,270	3,545	3,635	2,415	2,570	2,730	2,905	

## LOWBACK



## MEDIUMBACK



<b>1465</b>	18½-21½	25	25	25	40½													
<b>(Model #1)</b>	Urethane arm					1¼	30	<b>2,010</b>	<b>2,110</b>	<b>2,140</b>	<b>3,125</b>	<b>3,420</b>	<b>3,545</b>	<b>2,130</b>	<b>2,235</b>	<b>2,355</b>	<b>2,475</b>	
<b>(Model #9)</b>	Urethane arm with wrap					1½	32	2,205	2,330	2,390	3,420	3,725	3,850	2,355	2,485	2,620	2,775	
<b>(Model #2)</b>	Urethane arm with cap					1½	32	<b>2,205</b>	<b>2,330</b>	<b>2,390</b>	<b>3,420</b>	<b>3,725</b>	<b>3,850</b>	<b>2,355</b>	<b>2,485</b>	<b>2,620</b>	<b>2,775</b>	
<b>(Model #3)</b>	Urethane arm with cap and wrap					1¾	34	2,295	2,400	2,480	3,485	3,805	3,930	2,465	2,610	2,780	2,950	

## HIGHBACK



<b>1466</b>	18½-21½	25	25	25	45													
<b>(Model #1)</b>	Urethane arm					1¼	36	<b>2,045</b>	<b>2,145</b>	<b>2,205</b>	<b>3,210</b>	<b>3,510</b>	<b>3,625</b>	<b>2,165</b>	<b>2,270</b>	<b>2,390</b>	<b>2,510</b>	
<b>(Model #9)</b>	Urethane arm with wrap					1¾	38	2,260	2,390	2,465	3,505	3,825	3,955	2,430	2,580	2,745	2,915	
<b>(Model #2)</b>	Urethane arm with cap					1¾	38	<b>2,260</b>	<b>2,390</b>	<b>2,415</b>	<b>3,385</b>	<b>3,685</b>	<b>3,805</b>	<b>2,430</b>	<b>2,580</b>	<b>2,745</b>	<b>2,915</b>	
<b>(Model #3)</b>	Urethane arm with cap and wrap					2	40	2,340	2,455	2,570	3,580	3,900	4,045	2,530	2,700	2,890	3,080	

Senator Boardroom series is available as CAL 133 certified for an upcharge of \$175 list per chair. Certification applies to Nienkämper leathers and fabrics that have a minimum of 50% natural fibre content. COM's and COL's are subject to approval. Add the extension "-CAL" to the model number when ordering.

Specify model number for arm selection.

### Standard Features:

- Pneumatic height adjustment
- Back tilt locking mechanism
- Back tilt tension control
- Carpet casters
- Black five-star base

### Optional Features:

- Hard floor casters, add \$105 list per chair
- Glides, add \$105 list per chair
- Polished aluminum five-star base, add \$210 list

Model # 14652  
Medium Back



Model # 14652  
Medium Back



# OFFICE SEATING

Senator® CEO Designer – Nienkämper

— US Only —

Model Number	Seat H"	Arm H"	W"	D"	H"	Fabric Yds.	Leather Sq. Ft.	COM	COL	Verde	Grano	Cremoso	Knoll Textiles					
													1	2	3	4		
<b>LOW BACK</b>																		
1461__	18½-21½	25	25	28	36													
(Model #1) Urethane arm						2	34											
(Model #9) Urethane arm with wrap						2¼	37	3,145	3,295	4,485	4,845	4,990	3,360	3,555	3,765	3,990		
(Model #2) Urethane arm with cap						2¼	27	3,145	3,295	4,485	4,845	4,990	3,360	3,555	3,765	3,990		
(Model #3) Urethane arm with cap and wrap						2½	39	3,235	3,380	4,715	5,105	5,270	3,475	3,690	3,920	4,160		
(Model #8) Closed arm						2¾	44	3,585	3,770	5,235	5,665	5,835	3,845	4,080	4,345	4,605		

## MEDIUM BACK

1462__	18½-21½	25	25	28	40½													
(Model #1) Urethane arm						2¼	38	3,055	3,200	4,395	4,765	4,895	3,270	3,460	3,670	3,895		
(Model #9) Urethane arm with wrap						2½	41	3,255	3,420	4,765	5,160	5,315	3,495	3,710	3,940	4,185		
(Model #2) Urethane arm with cap						2½	41	3,255	3,420	4,765	5,160	5,315	3,495	3,710	3,940	4,185		
(Model #3) Urethane arm with cap and wrap						2¾	43	3,350	3,510	4,995	5,425	5,605	3,615	3,850	4,115	4,375		
(Model #8) Closed arm						3	48	3,700	3,895	5,490	5,970	6,170	3,980	4,245	4,525	4,815		

## HIGH BACK

1463__	18½-21½	25	25	28	45													
(Model #1) Urethane arm						2½	40	3,635	3,820	5,145	5,535	5,705	3,875	4,090	4,325	4,570		
(Model #9) Urethane arm with wrap						2¾	43	3,145	4,055	5,525	5,940	6,125	3,405	3,650	3,910	4,165		
(Model #2) Urethane arm with cap						2¾	43	3,875	4,055	5,525	5,940	6,125	4,135	4,375	4,635	4,895		
(Model #3) Urethane arm with cap and wrap						3	45	3,950	4,145	5,755	6,215	6,415	4,240	4,495	4,785	5,070		
(Model #8) Closed arm						3¼	50	4,320	4,535	6,275	6,765	6,970	4,620	4,905	5,215	5,530		

Senator CEO series is available as CAL 133 certified for an upcharge of \$305 list per chair. Certification applies to Nienkämper leathers and fabrics that have a minimum of 50% natural fibre content. COM's and COL's are subject to approval. Add the extension "-CAL" to the model number when ordering.

Specify model number for arm selection.

### Standard Features:

- Pneumatic height adjustment
- Back tilt locking mechanism
- Back tilt tension control
- Carpet casters
- Black five-star base

### Optional Features:

- Hard floor casters, add \$105 list per chair
- Glides, add \$105 list per chair
- Polished aluminum five-star base, add \$210 list

Model # 14622  
Medium Back





# OFFICE SEATING

Senator® Classic Designer – Nienkämper

— US Only —

Model Number	Seat H"	Arm		D"	H"	Fabric Yds.	Leather Sq.Ft.	COM	COL	Verde	Grano	Cremoso	Knoll Textiles			
		H"	W"										1	2	3	4

## MEDIUM BACK



<b>14101</b>	19½-23	25½	25½	26	41-44½	3	54												
								3,780	3,960	5,605	6,100	6,300	4,065	4,330	4,610	4,900			

## HIGHBACK



<b>14102</b>	19½-23	25½	25½	26	44½-49	3	59												
								4,400	4,615	6,390	6,920	7,120	4,685	4,950	5,230	5,525			





### Standard Features

- Pneumatic height adjustment
- Back tilt locking mechanism
- Back tilt tension control
- Carpet casters
- Black five-star base



# OFFICE SEATING

Senator® Executive Designer – Nienkämper



— US Only —

Model Number	Seat H"	Arm				Fabric Yds.	Leather Sq.Ft.	Knoll Textiles											
		H"	W"	D"	H"			COM	COL	Neather	Verde	Grano	Cremoso	1	2	3	4		
<b>LOW BACK</b>																			
 	1411__	18½-21½	25	25	26	36													
<b>(Model #1)</b>	Urethane arm						1¼	32	<b>2,700</b>	<b>2,835</b>	<b>2,900</b>	<b>3,900</b>	<b>4,215</b>	<b>4,345</b>	<b>2,870</b>	<b>3,015</b>	<b>3,180</b>	<b>3,350</b>	
<b>(Model #2)</b>	Urethane arm with cap						2	35	2,920	3,065	3,145	4,240	4,575	4,710	3,115	3,285	3,475	3,665	
 	<b>(Model #3)</b>	Urethane arm with cap & wrap						2¼	37	<b>2,970</b>	<b>3,140</b>	<b>3,235</b>	<b>4,370</b>	<b>4,720</b>	<b>4,875</b>	<b>3,185</b>	<b>3,380</b>	<b>3,590</b>	<b>3,815</b>
<b>(Model #8)</b>	Closed arm						2¾	42	3,335	3,485	3,620	4,895	5,315	5,480	3,595	3,835	4,095	4,355	
<b>(Model #7)</b>	Sled base with cap						2¼	34	<b>3,690</b>	<b>3,880</b>	<b>3,940</b>	<b>4,965</b>	<b>5,295</b>	<b>5,430</b>	<b>3,905</b>	<b>4,095</b>	<b>4,300</b>	<b>4,525</b>	

## MEDIUM BACK

 	1412__	18½-21½	25	25	26	40½												
<b>(Model #1)</b>	Urethane arm						2	36	2,830	2,960	3,055	4,175	4,535	4,670	3,025	3,195	3,385	3,580
<b>(Model #2)</b>	Urethane arm with cap						2¼	39	<b>3,015</b>	<b>3,165</b>	<b>3,255</b>	<b>4,480</b>	<b>4,870</b>	<b>5,010</b>	<b>3,235</b>	<b>3,430</b>	<b>3,635</b>	<b>3,855</b>
<b>(Model #3)</b>	Urethane arm with cap & wrap						2½	41	3,110	3,255	3,380	4,645	5,050	5,200	3,345	3,560	3,800	4,040
<b>(Model #8)</b>	Closed arm						3	46	<b>3,440</b>	<b>3,610</b>	<b>3,770</b>	<b>5,160</b>	<b>5,605</b>	<b>5,795</b>	<b>3,720</b>	<b>3,980</b>	<b>4,265</b>	<b>4,560</b>

## HIGH BACK

 	1413__	18½-21½	25	25	26	45												
<b>(Model #1)</b>	Urethane arm						2¼	38	3,380	3,550	3,620	4,800	5,175	5,325	3,595	3,790	4,005	4,225
<b>(Model #2)</b>	Urethane arm with cap						2½	41	<b>3,590</b>	<b>3,775</b>	<b>3,875</b>	<b>5,115</b>	<b>5,530</b>	<b>5,705</b>	<b>3,830</b>	<b>4,045</b>	<b>4,275</b>	<b>4,515</b>
<b>(Model #3)</b>	Urethane arm with cap & wrap						2¾	43	3,670	3,845	3,960	5,270	5,705	5,870	3,930	4,165	4,435	4,690
<b>(Model #8)</b>	Closed arm						3	48	<b>4,005</b>	<b>4,185</b>	<b>4,340</b>	<b>5,795</b>	<b>6,275</b>	<b>6,465</b>	<b>4,280</b>	<b>4,545</b>	<b>4,825</b>	<b>5,115</b>

Senator Executive series is available as CAL 133 certified for an upcharge of \$305 list per chair. Certification applies to Nienkämper leathers and fabrics that have a minimum of 50% natural fibre content. COM's and COL's are subject to approval. Add the extension "-CAL" to the model number when ordering.

Specify model number for arm selection.

### Standard Features:

- Pneumatic height adjustment
- Back tilt locking mechanism
- Tension control
- Carpet casters
- Black five-star base

### Optional Features:

- Hard floor casters, add \$105 list per chair
- Glides, add \$105 list per chair
- Polished aluminum five-star base, add \$210 list
- Chrome finish sled base, add \$165 list

### Upholstery Details:

- Leather upholstery has channel stitching.
- Fabric upholstery is available with channel stitch finished with a French seam detail.

Model # 14122  
Medium Back



Model # 1  
Urethane Arm



Model # 2  
Urethane arm  
with Cap



Model # 3  
Urethane Arm with  
Cap and Wrap



Model # 8  
Closed Arm



# OFFICE SEATING

Senator Mesh Back Chair Designer – Nienkämper

— US Only —

Model Number	Seat H"	Arm H"	W"	D"	H"	Fabric Yds.	Leather Sq. Ft.	COM	COL	Neather	Verde	Grano	Cremoso	KnollTextiles			
														1	2	3	4

## SENATOR MESH BACK CHAIR - ADJUSTABLE ARMS



														Upholstered seat									
<b>14301</b>	Grey arms, back frame and base													1,070	1,120	1,145	1,470	1,540	1,575	1,140	1,200	1,280	1,350
	Grey arms, back frame and base													Mesh seat									
<b>14302</b>	Grey arms, back frame and base													1,070									

## SENATOR MESH BACK CHAIR - ADJUSTABLE ARMS



														Upholstered seat									
<b>14305</b>	Black arms, back frame and base													1,010	1,050	1,080	1,410	1,480	1,510	1,085	1,145	1,220	1,295
	Black arms, back frame and base													Mesh seat									
<b>14306</b>	Black arms, back frame and base													1,010									

### Standard Features

- Mesh back, fabric seat & headrest is standard in black
- Mesh back with lumbar support, lumbar support has 2" adjustment
- Adjustment arms with 3" height adjustment and 1 3/4" depth adjustment
- Pneumatic height adjustment
- Black or grey five star base is standard, add \$105 list for polished aluminum base with chrome casters

Model # 14301



Model # 14301



# OFFICE SEATING

Senator® Nuvo Designer – Nienkämper

— US Only —

Model Number	Seat H"	Arm H"	W"	D"	H"	Fabric Yds.	Leather Sq.Ft.	COM	COL	Verde	Grano	Cremoso	Knoll Textiles			
													1	2	3	4

## ARMCHAIR SLED BASE

	14103	17½	24½	23	25	31	1¼	31										
									2,135	2,240	2,750	3,005	3,070	2,250	2,360	2,480	2,595	

### Standard Features

- Chrome tubular sled base
- Plain upholstery

	14104	17½	24½	23	25	31	1¼	31										
									3,290	3,455	3,900	4,155	4,240	3,405	3,515	3,635	3,750	

### Standard Features

- Solid flat chrome sled base
- Tufted upholstery

## ARMCHAIR CASTERBASE

	14107	17½	24½	23	25	31	1¼	31										
									2,340	2,460	2,940	3,145	3,200	2,455	2,565	2,685	2,800	

### Standard Features

- Chrome or black base
- Chrome or black casters
- Plain upholstery

Model # 14103  
Senator® Nuvo Armchair  
with tubular chrome sled base



Model # 14105  
Senator® Nuvo Armchair  
with flat chrome sled base

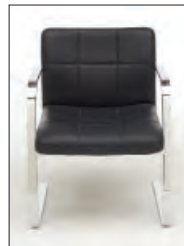

Model # 14107  
Senator® Nuvo Armchair Caster Base



# OFFICE SEATING

Senit Chair Designer – Nienkämper

— US Only —

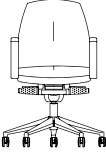
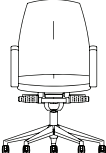
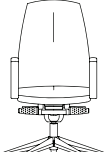
Model Number	Seat H"	Arm				Fabric Yds.	Leather Sq. Ft.	COM	COL	Neather	Verde	Grano	Cremoso	Knoll Textiles				
		H"	W"	D"	H"									1	2	3	4	
<b>LOW BACK</b>																		
	10950	18½-21½	25	25	25	36	1¼	22	1,010	1,060	1,125	1,600	1,810	1,860	1,125	1,235	1,355	1,470
<b>MEDIUM BACK</b>																		
	10951	18½-21½	25	25	25	40½	1¼	30	1,030	1,075	1,150	1,845	2,120	2,200	1,150	1,255	1,380	1,495
<b>HIGH BACK</b>																		
	10952	18½-21½	25	25	25	45	1½	36	1,065	1,105	1,200	2,035	2,375	2,475	1,205	1,340	1,480	1,625

### Standard Features:

- Pneumatic height adjustment
- Back tilt locking mechanism
- Back tilt tension control
- Carpet casters
- Black five-star base

### Optional Features:

- Hard floor casters, add \$105 list per chair
- Glides, add \$105 list per chair
- Polished aluminum five-star base, add \$210 list

Model # 10952



# OFFICE SEATING

Shaker Designer – Nienkamper

— US Only —

Model Number	Seat H"	W"	D"	H"	Fabric Yds.	Leather Sq.Ft.	COM	COL	Neather	Verde	Grano	Cremoso	KnollTextiles			
													1	2	3	4

## SHAKER CHAIR - SWIVEL BASE



<b>13910</b>	17½"	24½"	21¼"	29¼"	1¼"	28	2,455	2,580	2,610	3,345	3,445	3,530	2,535	2,600	2,680	2,755
--------------	------	------	------	------	-----	----	-------	-------	-------	-------	-------	-------	-------	-------	-------	-------

## SHAKER CHAIR - ON LEGS

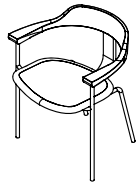

<b>13911</b>	17¼"	24½"	21½"	28½"	1¼"	28	2,190	2,305	2,355	3,075	3,175	3,265	2,275	2,345	2,415	2,495
--------------	------	------	------	------	-----	----	-------	-------	-------	-------	-------	-------	-------	-------	-------	-------

## SHAKER CHAIR - ON WOOD LEGS

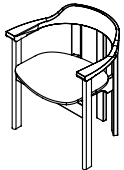

<b>13912</b>	17¼"	24½"	21½"	28½"	1¼"	28	2,905	3,650	3,750	3,835	2,825	2,895	2,970	3,045	2,825	2,900
--------------	------	------	------	------	-----	----	-------	-------	-------	-------	-------	-------	-------	-------	-------	-------

### Model # 13910, 13911 & 13912 Shaker Chairs



#### Standard Features

- Shaped hardwood arm, back and j-bar.
- Tubular steel leg frame, caster base and four wooden legs are standard
- Solid wood maple back/leg available in various Nienkamper stains and sheen levels.
- Upholstery available in all Neinkamper standard fabrics and leather.
- Metal base standard in satin black powder coat.

# OFFICE SEATING

Slim Chair Designer – Nienkämper

— US Only —

Model Number	Seat H"	Arm H"	W"	D"	H"	Fabric Yds.	Leather Sq.Ft.	COM	COL	Neather	Verde	Grano	Cremoso	Knoll Textiles			
														1	2	3	4

## SLIM HIGH BACK - ARMLESS



<b>10761</b>	19-22		19	25	45	1%	30	1,325	1,400	1,500	2,235	2,385	2,465	1,495	1,640	1,805	1,965
--------------	-------	--	----	----	----	----	----	-------	-------	-------	-------	-------	-------	-------	-------	-------	-------

## SLIM HIGH BACK - FIXED ARM



<b>10762</b>	19-22	26-29	25½	25	45	1%	30	1,600	1,675	1,760	2,505	2,670	2,745	1,755	1,910	2,060	2,230
--------------	-------	-------	-----	----	----	----	----	-------	-------	-------	-------	-------	-------	-------	-------	-------	-------

## SLIM HIGH BACK - CANTILEVER ARM



<b>10763</b>	19-22	26-29	25½	25	45	1%	30	1,565	1,630	1,705	2,300	2,445	2,510	1,725	1,870	2,035	2,195
--------------	-------	-------	-----	----	----	----	----	-------	-------	-------	-------	-------	-------	-------	-------	-------	-------

### Standard Features

- Moulded plywood seat shell
- Soy based flexible polyurethane foam
- Fixed arm model has polished aluminum arm supports and black soft textured arm cap
- Cantilever arm model has polished sides with black textured arm cap
- Pneumatic height adjustment
- Back tilt locking mechanism
- Carpet casters
- Black five-star base & casters

### Optional Features

- Hard floor casters, add \$105 list per chair
- Glides, add \$105 list per chair
- Polished aluminum five-star base with chrome casters, add \$70 list

Model # 10761



Model # 10762



Model # 10763



Slim high back with cantilever arms with polished sides and black textured arm cap

# OFFICE SEATING

Trench - Upholstered Arms Designer – Favaretto & Partners

— US Only —

Model Number	Seat H"	Arm H"	W"	D"	H"	Fabric Yds.	Leather Sq.Ft.	COM	COL	Neather	Verde	Grano	Cremoso	KnollTextiles			
														1	2	3	4

## TRENCH LOW BACK - UPHOLSTERED ARMS



<b>10371</b>	18-21	27-30	25½	26	35½-38½	2½	45	2,365	2,485	2,590	3,620	3,840	3,945	2,600	2,815	3,055	3,295
--------------	-------	-------	-----	----	---------	----	----	-------	-------	-------	-------	-------	-------	-------	-------	-------	-------

Extra sq. ft. COL for pleats detail on inside back: 5

## TRENCH MEDIUM BACK - UPHOLSTERED ARMS



<b>10372</b>	18-21	27-30	25½	26	40½-43½	3	54	2,475	2,595	2,745	3,960	4,225	4,350	2,755	3,015	3,300	3,590
--------------	-------	-------	-----	----	---------	---	----	-------	-------	-------	-------	-------	-------	-------	-------	-------	-------

Extra sq. ft. COL for pleats detail on inside back: 5

## TRENCH HIGH BACK WITH HEADREST - UPHOLSTERED ARMS



<b>10373</b>	18-21	27-30	25½	26	48½-51½	3-½	63	2,805	2,955	3,125	4,545	4,850	5,000	3,140	3,445	3,770	4,110
--------------	-------	-------	-----	----	---------	-----	----	-------	-------	-------	-------	-------	-------	-------	-------	-------	-------

Extra sq. ft. COL for pleats detail on inside back: 5

### Standard Features

- Seat depth : 20"D, Headrest : 8"H
- Steel frame with polyurethane foam
- Distinctive pleats on the convex inside back for both leather & fabric upholstery is standard in Verde leather
- Extra 5 sqft. COL is required for pleats detail
- Upholstered arms and adjustable arms are both available
- Pneumatic height adjustment
- Synchronized seat and back recline
- Black five star base and 3" dia. carpet casters are standard
- Add \$70 list for mirror polished base with chrome casters

Model # 10372



Trench medium back chair upholstered in Ecopell leather, colour Caramel EC363 with Ecopell leather, colour Milkshake EC737 pleats detail on inside back



# OFFICE SEATING

Vuelo Designer – Johnson chow

— US Only —

Model Number	Seat H"	Arm H"	W"	D"	H"	Fabric Yds.	Leather Sq.Ft.	COM	COL	Neather	Verde	Grano	Cremoso	KNOLL TEXTILES			
														1	2	3	4
<b>VUELO LOWBACK</b>																	
	17-20	23-26	26	23½	33-36												
	<b>10072</b>	fully upholstered				2¼	41	2,825	2,970	3,055	4,075	4,300	4,425	3,045	3,240	3,450	3,670
	<b>10072/1</b>	contrasting fabric seat & back arms & bottom				1¼	1	2,825		3,055				2,950	3,060	3,175	3,295
	<b>10072/2</b>	contrasting leather seat & back arms & bottom				23			2,970		4,075	4,300	4,425				
<b>10072/3</b>	fabric seat & back with Verde leather arms & bottom					1¼	18	3,460						3,580	3,690	3,810	3,925

## VUELO HIGH BACK

	17-20	23-26	26	25	42-45													
	<b>10071</b>	fully upholstered				2½	45	3,060	3,210	3,300	4,440	4,675	4,800	3,295	3,510	3,740	3,990	
	<b>10071/1</b>	contrasting fabric seat & back arms & bottom				1½	1	3,060		3,300				3,195	3,330	3,475	3,620	
	<b>10071/2</b>	contrasting leather seat & back arms & bottom				27			3,210		4,075	4,300	4,425					
<b>10071/3</b>	fabric seat & back with Verde leather arms & bottom					1½	18	3,700						3,840	3,965	4,115	4,260	

Model # 10072



Model # 10072/3

Fabric seat and back with Verde leather arms & bottom.



### Standard features:

- Moulded plywood seat and arm shell
- Soy based flexible polyurethane foam
- Polished aluminum five star base with chrome casters
- Pneumatic Height Adjustment
- Back tilt locking mechanism
- For model "/3" with fabric seat & back and verde leather arms & bottom, welting detail on the back in same Verde leather is standard

# nienkämper

International Inc.

## SIDE CHAIRS



# SIDE CHAIRS

## TABLE OF CONTENTS







---

<b>Side Chairs</b>	<b>43-54</b>
Brackett®	45
HSC	46
Kush	47
Nabu Side/Stacking Chair	48-50
Q Side Chair	51
Schultz	52
Senator® Nuvo Sled Base	53
Unesco™	54

# SIDE CHAIRS

Brackett® Chair Designer – lothar windel

— US Only —

Model Number	Seat H"	Arm		D"	H"	Fabric Leather		COM	COL	Verde	Grano	Cremoso	Knoll Textiles										
		H"	W"			Yds.	Sq.Ft.						1	2	3	4							
<b>LOW BACK</b>																							
	Five-star black base																						
<b>14761</b>	17½-20½	24½	26	26	31½-34½	2¼	40								1,820	1,920	3,065	3,385	3,510	2,035	2,230	2,440	2,665
	Four legs																						
<b>14762</b>	18½	25½	26	23	32	2¼	40								1,705	1,785	2,950	3,270	3,400	1,925	2,120	2,330	2,550
	Sled base																						
<b>14763</b>	18½	25½	26	23	32	2¼	40								1,730	1,810	2,960	3,290	3,420	1,945	2,140	2,350	2,570
<b>MEDIUM BACK</b>																							
	Five-star black base																						
<b>14765</b>	17½-20½	24½	26	26	36½-39½	2¼	45								1,855	1,950	3,250	3,620	3,775	2,070	2,265	2,480	2,700
	Four legs																						
<b>14766</b>	18½	25½	26	23	37	2½	45								1,735	1,815	3,135	3,490	3,635	1,970	2,185	2,415	2,670
	Sled base																						
<b>14767</b>	18½	25½	26	23	37	2½	45								1,745	1,840	3,145	3,505	3,675	1,980	2,195	2,430	2,680

## Standard Features

- Pneumatic height adjustment (Five-star base)
- Black tilt locking mechanism (Five-star base)
- Tension control (Five-star base)

## Optional Features

- Hard floor casters, add \$105 list per chair
- Polished Aluminum Five-star base, add \$150
- Swivel pedestal base in brushed nickel finish add \$315 list per chair on pricing of five star base model
- Specify chrome or black legs
- Specify chrome or black sled base

**Brackett  
Model #14761**



**Brackett  
Model #14762**



**Brackett  
Model #14765**



**Brackett with swivel  
pedestal base**



# SIDE CHAIRS

HSC Designer - HUB Design Studio

— US Only —

Model Number	Seat H"	W"	D"	H"	Fabric		COM	COL	Neather	Verde	Grano	Cremoso	Knoll Textiles			
					Yds.	Sq.Ft.							1	2	3	4

## HSC CHAIR ON WOOD LEGS



<b>38801</b>	17	25¾	24	31	2½	45	2,395	2,515	2,625	3,660	3,875	3,980	2,635	2,855	3,085	3,330
--------------	----	-----	----	----	----	----	-------	-------	-------	-------	-------	-------	-------	-------	-------	-------

## HSC CHAIR ON STEEL LEGS



<b>38802</b>	17	25¾	24	31	2½	45	1,910	2,005	2,135	3,140	3,355	3,465	2,145	2,360	2,590	2,830
--------------	----	-----	----	----	----	----	-------	-------	-------	-------	-------	-------	-------	-------	-------	-------

## HSC CHAIR ON CASTER BASE



<b>38803</b>	17-20	25¾	24	31-34	2½	45	1,840	1,935	2,065	3,075	3,290	3,395	2,075	2,295	2,530	2,775
--------------	-------	-----	----	-------	----	----	-------	-------	-------	-------	-------	-------	-------	-------	-------	-------

### Standard features:

- Seat depth: 18"; Seat width: 20½"
- Molded foam frame with flexible foam on seat and back.
- Wood legs available in 3 species: solid yellow birch, maple or walnut and finished natural or stained with any Nienkämper standard color.
- Steel legs available in silver, black or warm white powder coat finish.
- 5 star caster base is standard in mirror polished finish with chrome carpet casters.
- Pneumatic height adjustment and back tilt locking mechanism are standard features for caster base.

Model #38801



Model #38802



Model #38803



# SIDE CHAIRS

Kush Designer - MSDS Studio

— US Only —

Model Number	Seat H"	Arm H"	W"	D"	H"	Fabric		COM	COL	Neather	Verde	Grano	Cremoso	Knoll Textiles			
						Yds.	Sq.Ft.							1	2	3	4

## KUSH

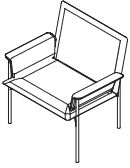

<b>10360</b>	19½	25½	28	25	34	3	54	2,665	2,790	2,925	2,990	4,410	4,550	2,940	3,200	3,490	3,775
--------------	-----	-----	----	----	----	---	----	-------	-------	-------	-------	-------	-------	-------	-------	-------	-------

### Model # 10360

Kush chair upholstered in Ecopell leather, colour Caramel EC 363.







### Standard features:

- Frame is constructed of FSC plywood core
- Seat & back cushions have a foam core with Dacron wrap
- Upholstered arm support with polyurethane foam
- Legs are standard in black powder coat finish

# SIDE CHAIRS

Nabu™ Stacking Chair and Nabu™ Side Chair – striped mesh back Designer - Bangdesign

— US Only —

Model Number	Seat H"	Arm H"	W"	D"	H"	Fabric		COM	COL	Neather	Verde	Grano	Cremoso	Knoll Textiles										
						Yds.	Sq. Ft.							1	2	3	4							
<b>NABU™ SIDE CHAIR WITH ARMS - SLED BASE</b>																								
	10631	18	26	22½	22½	36½	¾	9	upholstered seat with striped mesh back						1,450	1,505	1,525	1,755	1,815	1,845	1,525	1,590	1,655	1,735
									mesh seat with striped mesh back						1,470									
<b>NABU™ STACKING CHAIR ARMLESS - SLED BASE</b>																								
	10605	19		23½	22	32½	¾	9	upholstered seat with striped mesh back						945	1,005	1,015	1,150	1,200	1,245	1,025	1,085	1,165	1,235
									mesh seat with striped mesh back						980									
<b>NABU™ STACKING CHAIR ARMLESS - ON 4 LEGS</b>																								
	10607	19		23½	22	32½	¾	9	upholstered seat with striped mesh back						925	1,070	1,080	1,215	1,270	1,305	1,005	1,065	1,135	1,210
									mesh seat with striped mesh back						980									
<b>NABU™ STACKING CHAIR ARMLESS - ON 4 LEGS WITH CASTERS</b>																								
	10633	19		23½	22	32½	¾	9	upholstered seat with striped mesh back						1,025	1,165	1,175	1,305	1,355	1,400	1,095	1,165	1,235	1,305
									mesh seat with striped mesh back						1,040									

NOTE:  
White frame add - WH, Grey frame add - GR

**Nabu™ Chairs (striped mesh back) are available as CAL 133 certified for an upcharge of \$135 list per chair. Certification applies to Nienkämper leathers and fabrics that have a minimum of 50% natural fibre content. COM's and COL's are subject to approval. Add the extension "-CAL" to the model number when ordering.**

**Standard features:**

- Seat available in 29 solid mesh colors. Back available in 34 contrasting mesh stripe. Back mesh has a horizontal stripe pattern as standard created by the strong elastomer fiber woven in the mesh.
- Cushions are molded foam with 25% soy foam content
- Nabu side chair with arms on sled base available in polished chrome or black polished finish
- Arm clip in black urethane as a standard or upholstered arm cap to match the seat with an upcharge \$80 list per chair (plus addition 2 sq. ft. COL)
- Tubular steel leg or sled base is standard silver powder coat
- Back frame and arms are black as standard. White and grey optional. Custom colors available for quantities above 100.
- Models 10605 through 10608 are stackable - 6 high on floor and 10 high on dolly. Footprint 23" wide x 32" deep.
- Dolly priced separately.

Model # 10605



Model # 10631



Model # 10607



Model # 10633



# SIDE CHAIRS

Nabu™ Stacking Chair and Nabu™ Side Chair – fully upholstered back Designer - Bangdesign

— US Only —

Model Number	Seat H"	Arm H"	W"	D"	H"	Fabric Yds.	Leather Sq. Ft.	COM	COL	Knoll Textiles				— US Only —			
										Neather	Verde	Grano	Cre moso	1	2	3	4

## NABU™ SIDE CHAIR WITH ARMS - SLED BASE

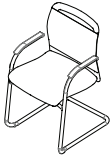

10635	18	26	22½	22½	36½	1⅓	22	fully upholstered seat & back							
								1,845	1,920	1,980	2,515	2,645	2,710	1,975	2,090
10636	18	26	22½	22½	36½	¾	13	mesh seat with fully upholstered back							
								1,860	1,935	1,965	2,295	2,380	2,405	1,930	1,985

## NABU™ STACKING CHAIR ARMLESS - SLED BASE



10615	19		23½	22	32½	1⅓	22	fully upholstered seat and back							
								1,200	1,245	1,325	1,845	1,970	2,040	1,325	1,445
10616	19		23½	22	32½	¾	13	mesh seat with fully upholstered back							
								1,215	1,270	1,285	1,630	1,710	1,745	1,280	1,345

## NABU™ STACKING CHAIR ARMLESS - ON 4 LEGS



10617	19		23½	22	32½	1⅓	22	fully upholstered seat and back							
								1,175	1,230	1,305	1,830	1,955	2,030	1,300	1,415
10618	19		23½	22	32½	¾	13	mesh seat with fully upholstered back							
								1,200	1,250	1,270	1,545	1,690	1,730	1,260	1,320

## NABU™ STACKING CHAIR ARMLESS - ON 4 LEGS WITH CASTERS

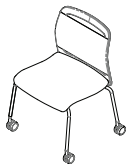

10637	19		23½	22	32½	1⅓	22	fully upholstered seat and back							
								1,270	1,310	1,400	1,925	2,045	2,120	1,400	1,510
10638	19		23½	22	32½	¾	13	mesh seat with fully upholstered back							
								1,285	1,340	1,355	1,640	1,775	1,815	1,350	1,410

**Nabu™ Chairs (fully upholstered back) are available as CAL 133 certified for an upcharge of \$135 list per chair. Certification applies to Nienkämper leathers and fabrics that have a minimum of 50% natural fibre content. COM's and COL's are subject to approval. Add the extension "-CAL" to the model number when ordering.**

### Standard features:

- Seat available in 29 solid mesh colors. Back available in 34 contrasting mesh stripe. Back mesh has a horizontal stripe pattern as standard created by the strong elastomer fiber woven in the mesh.
- Cushions are molded foam with 25% soy foam content
- Nabu side chair with arms on sled base available in polished chrome or black polished chrome finish
- Arm cap in black urethane as a standard or upholstered arm cap to match the seat with an upcharge \$80 list per chair (plus addition 2 sq. ft. COL)
- Tubular steel leg or sled base is standard silver powder coat
- Back frame is black as standard.
- Models 10605 through 10608 are stackable - 6 high on floor and 10 high on dolly. Footprint 23" wide x 32" deep.
- Dolly priced separately.

Model # 10615









# SIDE CHAIRS

Nabu™ Stacking Chair and Nabu™ Side Chair – fully upholstered mesh back Designer - Bangdesign

— US Only —

Model Number	Seat H"	Arm H"	W"	D"	H"	Fabric Leather		COM	COL	Neather	Verde	Grano	Cremoso	Knoll Textiles										
						Yds.	Sq.Ft.							1	2	3	4							
<b>NABU™ SIDE CHAIR WITH ARMS ON - SLED BASE</b>																								
	10639	18	26	22½	22½	36½	¾	9	upholstered seat with striped mesh back						1,535	1,600	1,615	1,850	1,915	1,935	1,610	1,670	1,745	1,820
										mesh seat with striped mesh back						1,555								
<b>NABU™ STACKING CHAIR ARMLESS - SLED BASE</b>																								
	10625	19		23½	22	32½	¾	9	upholstered seat with striped mesh back						990	1,030	1,065	1,180	1,230	1,275	1,065	1,125	1,200	1,275
										mesh seat with striped mesh back						1,010								
<b>NABU™ STACKING CHAIR ARMLESS - ON 4 LEGS</b>																								
	10627	19		23½	22	32½	¾	9	upholstered seat with striped mesh back						970	1,095	1,105	1,280	1,290	1,340	1,040	1,100	1,180	1,250
										mesh seat with striped mesh back						990								
<b>NABU™ STACKING CHAIR ARMLESS - ON 4 LEGS WITH CASTERS</b>																								
	10641	19		23½	22	32½	¾	9	upholstered seat with striped mesh back						1,060	1,190	1,205	1,340	1,385	1,435	1,130	1,195	1,270	1,345
										mesh seat with striped mesh back						1,075								

**Standard features:**

- Seat available in 29 solid mesh colors. Back available in 34 contrasting mesh stripe. Back mesh has a horizontal stripe pattern as standard created by the strong elastomer fiber woven in the mesh.
- Cushions are molded foam with 25% soy foam content
- Nabu side chair with arms on sled base available in polished chrome or black polished finish
- Arm clip in black urethane as a standard or upholstered arm cap to match the seat with an upcharge \$80 list per chair (plus addition 2 sq. ft. COL)
- Tubular steel leg or sled base is standard silver powder coat
- Back frame and arms are black as standard.
- Models 10605 through 10608 are stachable - 6 high on floor and 10 high on dolly. Footprint 23" wide x 32" deep.
- Dolly priced separately.

# SIDE CHAIRS

Q Chair Designer - Q Design

— US Only —

Model Number	Seat H"	Arm H"	W"	D"	H"		Fabric Yds.	Leather Sq.Ft.	COM	COL	Neather	Verde	Grano	Cremoso	Knoll Textiles			
															1	2	3	4

## Q LOUNGE CHAIR WITH VENEER



10051	16½	21¼	31½	31	34½	2	36		4,115	4,320	4,315	5,295	5,490	5,590	4,300	4,475	4,665	4,855
-------	-----	-----	-----	----	-----	---	----	--	-------	-------	-------	-------	-------	-------	-------	-------	-------	-------

## Q LOUNGE CHAIR - FULLY UPHOLSTERED



10053	15	20	31½	31	34½	4	72		3,905	4,105	4,090	5,035	5,215	5,320	4,280	4,630	5,005	5,390
-------	----	----	-----	----	-----	---	----	--	-------	-------	-------	-------	-------	-------	-------	-------	-------	-------

## Q SIDE CHAIR WITH VENEER



10052	18	24	27½	23	34	1½	27		3,545	3,710	3,690	4,450	4,595	4,670	3,690	3,820	3,955	4,110
-------	----	----	-----	----	----	----	----	--	-------	-------	-------	-------	-------	-------	-------	-------	-------	-------

## Q SIDE CHAIR - FULLY UPHOLSTERED



10054	18	24	27½	23	34	3	54		3,360	3,525	3,500	4,230	4,370	4,445	3,650	3,910	4,190	4,480
-------	----	----	-----	----	----	---	----	--	-------	-------	-------	-------	-------	-------	-------	-------	-------	-------

Model # 10051



Model # 10052



### Standard features:

- Moulded plywood seat & arm shell
- Soy based flexible polyurethane foam
- Maple or walnut veneer with any Nienkämper stains is available for model with veneer finish (Model #10051 & #10052)
- Q Side Chair with veneer back has only seat & arm shell but a fully upholstered back
- Polished aluminum 4-star base on glides for Q Lounge chair
- Polished aluminum cross base for Q Side chair

# SIDE CHAIRS

Schultz Designer - Richard Schultz

Model Number	Seat H"	Arm		D"	H"	Fabric Leather		COM	COL	Verde	Grano	Cremoso	— US Only — Knoll Textiles			
		H"	W"			Yds.	Sq.Ft.						1	2	3	4

## LOUNGE CHAIR



<b>RS48</b>	15½	21	26	29	26½	1½	28	2,900	3,045	3,900	4,175	4,280	3,040	3,170	3,310	3,460
-------------	-----	----	----	----	-----	----	----	-------	-------	-------	-------	-------	-------	-------	-------	-------

## SIDE CHAIR

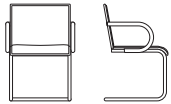

<b>RS46-1</b>	18	26	22½	23	32	1¼	20	2,830	3,005	3,635	3,845	3,920	2,955	3,065	3,180	3,300
---------------	----	----	-----	----	----	----	----	-------	-------	-------	-------	-------	-------	-------	-------	-------

**Model RS48  
Lounge Chair**



**Model RS46-1  
Side Chair**



The tubular steel frame standard finish is mirror polished chrome. For a stainless steel frame add \$810 list per chair. When the Lounge version, Model # RS48 is upholstered in fabric, channel stitching finishes the curve between the seat and back. Leather welting in Grano or Verde leather around the perimeter of the chair is standard. Unless the color of the leather welting is specified, Nienkämper will select a suitable color.

# OFFICE SEATING

Senator® Nuvo Designer – Nienkämper

— US Only —

Model Number	Seat H"	Arm H"	W"	D"	H"	Fabric Yds.	Leather Sq.Ft.	COM	COL	Verde	Grano	Cremoso	Knoll Textiles			
													1	2	3	4

## ARMCHAIR SLED BASE

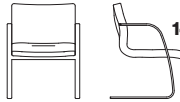
	14103	17½	24½	23	25	31	1¼	28	2,135	2,240	2,750	3,005	3,070	2,250	2,360	2,480	2,595

### Standard Features

- Chrome tubular sled base
- Plain upholstery

	14104	17½	24½	23	25	31	1¼	28	3,290	3,455	3,900	4,155	4,240	3,405	3,515	3,635	3,750

### Standard Features

- Solid flat chrome sled base
- Tufted upholstery

## ARMCHAIR CASTERBASE

	14107	17½	24½	23	25	31	1¼	28	2,340	2,460	2,940	3,145	3,200	2,455	2,565	2,685	2,800

### Standard Features

- Chrome or black base
- Chrome or black casters
- Plain upholstery

Model # 14103  
Senator® Nuvo Armchair  
with tubular chrome sled base



Model # 14105  
Senator® Nuvo Armchair  
with flat chrome sled base

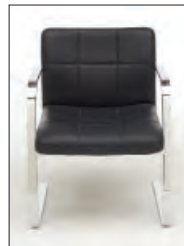

Model # 14107  
Senator® Nuvo Armchair Caster Base



# SIDE CHAIRS

Unesco™ Designer - Robert Haussmann

— US Only —

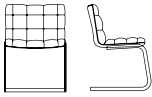
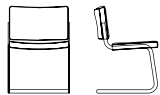
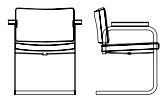
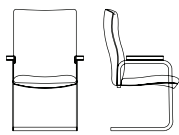
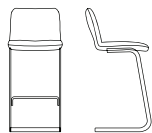
Model Number	Seat H"	Arm H"	W"	D"	H"	Fabric		Knoll Textiles								
						Yds.	Sq.Ft.	COM	COL	Verde	Grano	Cremoso	1	2	3	4
<b>SIDE CHAIR WITH BUTTON TUFTING</b>																
 <b>15600</b>	17½		20½	21	32	1½	24	2,565	2,680	3,465	3,690	3,780	2,705	2,830	2,975	3,125
<b>LOW BACK SIDE CHAIR</b>																
 <b>15601</b>	17½		20½	22	30	1¼	20	2,380	2,490	3,125	3,335	3,390	2,500	2,605	2,725	2,845
<b>LOW BACK</b>																
 <b>15611</b>	17½	25½	25½	22	30	1½	24	2,725	2,865	3,620	3,860	3,955	2,870	3,000	3,140	3,290
<b>HIGH BACK</b>																
 <b>15612</b>	17½	25½	25½	22	40	2½	40	2,835	2,970	4,340	4,720	4,890	3,080	3,295	3,525	3,770
<b>BAR STOOL</b>																
 <b>15613</b>	30		18	20	39½	1	16	2,565	2,680	3,150	3,305	3,380	2,665	2,745	2,835	2,935

**Unesco – Notes and Options**

Choose a brushed nickel or mirror-polished chrome finish for the oval-shaped tubular steel frame standard on all models.

**Optional Features:**

When ordering tufting on model numbers 15601, 15611, 15612, and 15613, add 20% to the list price and "-T" to the end of the model number.

**Model #15601**  
Low Back Side Chair



**Model #15611**  
Low Back



# nienkämper

International Inc.

## LOUNGE SEATING



# LOUNGE SEATING

## TABLE OF CONTENTS

### Lounge Seating

32 Collection	57
Baden	58-59
Bare	60
BASS Collection	61-62
Bay	63
Belle	64
Berkley® Collection	65-70
Bern	71
Blob	72
BLOOR® Collection	73
Carlisle	74
Cocoon	75
Divvi	76
Dobi	77
Dune	78-79
Eden®	80-95
Elite	96
Expo 67	97
Godbout	98
HAB™	99
Heartbeat	100-101
Ingmar Lounge	102
Isola 8	103
J + J Studio	104
Kloud® Collection	105
Kloud® Serpentine™	106
LCS Club	107
Leaf	108
LINQ	109

### 55-154

LolliPOP	110
Lucerne	111
Max™	112-118
Mood Collection	119
Nordic	120
Note	121
Paris Archive	122
Patkau Twist	123
Polo	124
Pullman™	125-126
Pyramid Chair	127
Q Chair	128
Radius	129
Radius on Legs	130
Rowan Lounge	131
Satori™	132
Six® Collection	133
Spirit	134
Turnaround® Collection	135
Tuxedo™	136-137
Tuxedo Classic™	138-141
Tuxedo Cove	142-145
Tuxedo™ High Back	146-147
Vuelo Lounge	148
Wavelength®	149-150
Work:Recline	151
Yabaco	152
Yabaco	153
Zurich	154

# LOUNGE SEATING

32 Collection

— US Only —

Knoll Textiles

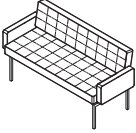
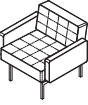
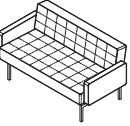
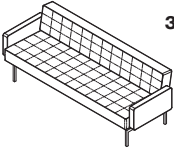
Model Number	Seat Arm			D"	H"	Fabric Yds.	Leather Sq. Ft.	COM	COL	Neather	Verde	Grano	Cremoso	Knoll Textiles			
	H"	H"	W"											1	2	3	4
<b>32 DINING CHAIR</b>																	
 <b>32011</b>	18½	24	27¾	25	31½	3	54	4,695	4,935	4,990	6,375	6,670	6,790	4,985	5,240	5,530	5,815
<b>32 DINING TWO SEAT SOFA</b>																	
 <b>32012</b>	18½	24	59¾	25	31½	4¾	86	6,985	7,340	7,450	9,645	10,095	10,310	7,435	7,850	8,290	8,755
<b>32 LOUNGE CHAIR</b>																	
 <b>32021</b>	16½	23	29¾	29¼	29½	4	72	5,050	5,305	5,430	7,230	7,600	7,790	5,430	5,775	6,150	6,540
<b>32 LOUNGE TWO SEAT SOFA</b>																	
 <b>32022</b>	16½	23	53¾	29¼	29½	6	108	7,400	7,770	7,975	10,675	11,220	11,495	7,965	8,480	9,045	9,625
<b>32 LOUNGE THREE SEAT SOFA</b>																	
 <b>32023</b>	16½	23	77¾	29¼	29½	8	144	8,240	8,660	9,010	12,530	13,265	13,295	8,995	9,695	10,445	11,215

**Standard Features:**

- Seat depth for Dining Collection: 18½"d
- Seat depth for Lounge Collection: 22"d
- Standard with tufting on seat & back
- Plywood frame with soy based polyurethane foam
- Support frame & legs are standard in brushed aluminum finish.
- Powder coat finishes also available upon request

**Model # 32011**  
32 dining chair upholstered in Ecopell leather, Blueberry EC700



**Model # 32012**  
32 Dining 2 Seat Sofa



**Model # 32023**  
32 Lounge 3 Seat Sofa







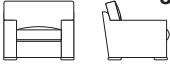
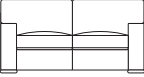

# LOUNGE SEATING

Baden/Zurich Designer – Nienkämper & robert haussmann

— US Only —

Model Number	Seat H"	Arm H"	W"	D"	H"	Fabric Yds.	Leather Sq. Ft.	Knoll Textiles								
								COM	COL	Verde	Grano	Cremoso	1	2	3	4
<b>LOUNGE CHAIR</b>																
 <b>312</b>	18	22	38	38	33	8	110	7,230	7,605	11,375	12,440	12,885	7,990	8,680	9,430	10,205
<b>TWO SEAT SOFA</b>																
 <b>312-2</b>	18	22	62	38	33	10	160	9,995	10,490	15,980	17,565	18,205	10,940	11,815	12,745	13,710
<b>THREE SEAT SOFA</b>																
 <b>312-3</b>	18	22	87	38	33	15	210	13,135	13,775	20,990	23,045	23,885	14,540	15,850	17,255	18,700
<b>FOUR SEAT SOFA</b>																
 <b>312-4</b>	18	22	112	38	33	18½	260	16,335	17,145	26,060	28,625	29,655	18,080	19,695	21,420	23,200
<b>OTTOMAN</b>																
 <b>312-5</b>			30	30	17	3¼	52	4,045	4,245	5,985	6,490	6,700	4,350	4,635	4,945	5,250

**Baden series passes CAL 133 certified for an upcharge of \$490 list per chair, \$975 list per two seater sofa, \$1460 list per three seat sofa, \$1945 list per four seat sofa, and \$485 list per ottoman. Certification applies to Nienkämper leathers and fabrics that have a minimum of 50% natural fibre content. COM's and COL's are subject to approval. Add the extension -CAL to the model number when ordering.**

When COM is lightweight, a welting detail is added to the perimeter of the seat and back cushions. Allow 5% additional yardage of COM to accommodate welting details.

When upholstered in leather, seat and back cushions have a foam core wrapped in a down and feather combination.

When upholstered in COM, seat and back cushions have a foam core wrapped in Dacron.

All seat and back cushions are loose.

Two base options are available. Radius feet, see photo on page 58, are offered ebonized as standard. Angled wood feet, see photo on page 58, are offered ebonized as standard. Both Radius and Angled feet are available in standard Nienkämper stains, see page 12 for a listing. To match custom stains add \$570 list per stain color.

**Model #312**



**Model #312-2**



**Model #312-3**



# LOUNGE SEATING

Baden/Zurich Designer – Nienkämper & robert haussmann

— US Only —

Model Number	Seat H"	Arm H"	W"	D"	H"	Fabric Yds.	Leather Sq. Ft.	COM	COL	Verde	Grano	Cremoso	Knoll Textiles			
													1	2	3	4

## SIX SEAT L-SHAPED SOFA

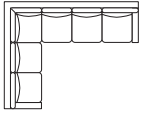

<b>312-6</b>	18	22	119	94	33	22	360	25,555	26,830	39,030	42,575	44,005	27,635	29,560	31,600	33,730
--------------	----	----	-----	----	----	----	-----	--------	--------	--------	--------	--------	--------	--------	--------	--------

## SEVEN SEAT L-SHAPED SOFA

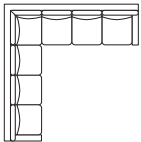

<b>312-7</b>	18	22	119	119	33	28	410	29,285	30,745	44,635	48,675	50,285	31,930	34,375	36,990	39,685
--------------	----	----	-----	-----	----	----	-----	--------	--------	--------	--------	--------	--------	--------	--------	--------

## EIGHT SEAT L-SHAPED SOFA

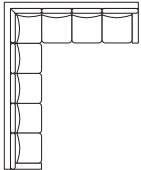

<b>312-8</b>	18	22	119	144	33	30	460	32,965	34,615	50,180	54,715	56,530	35,795	38,415	41,210	44,115
--------------	----	----	-----	-----	----	----	-----	--------	--------	--------	--------	--------	--------	--------	--------	--------

Baden series passes CAL 133 certified for an upcharge of \$2915 list for six seat, \$3400 list for seven seat, and \$3885 list for eight seat. Certification applies to Nienkämper leathers and fabrics that have a minimum of 50% natural fibre content. COM's and COL's are subject to approval. Add the extension -CAL to the model number when ordering.

When COM is lightweight, a welting detail is added to the perimeter of the seat and back cushions. Allow 5% additional yardage of COM to accommodate welting details.

When upholstered in leather, seat and back cushions have a foam core wrapped in a down and feather combination.

When upholstered in COM, seat and back cushions have a foam core wrapped in Dacron.

All seat and back cushions are loose.

Two base options are available. Radius feet, see photo below left, are offered ebonized as standard. Angled wood feet, see photo below right, are offered ebonized as standard. Both Radius and Angled feet are available in standard Nienkämper stains, see page 12 for a listing. To match custom stains add \$600 list per stain color.

Radius Foot



Angled Foot



# LOUNGE SEATING

Bare Designer - Evan bare

— US Only —

Model Number	Seat H"	Arm H"	Arm W"	D"	H"	Fabric Yds.	Leather Sq.Ft.	COM	COL	Neather	Verde	Grano	Cremoso	Knoll Textiles			
														1	2	3	4

## BARE CHAIR



<b>10321</b>	16¾	26		33	29½	3¾	68	4,620	4,865	4,995	6,690	7,025	7,205	4,985	5,305	5,655	6,020
					Seat	1¼	23										
					Back	2½	45										

## BARE TWO SEAT SOFA

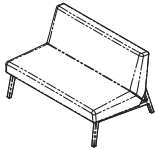

<b>10322</b>	16¾	50		33	29½	5¾	104	6,230	6,545	6,915	9,335	9,870	10,130	6,775	7,275	7,815	8,370
					Seat	2¼	41										
					Back	3½	63										

**Model # 10321**  
Bare Chair



**Model # 10322**  
Bare Two Seat Sofa



### Standard Features:

- Seat depth: 21"d
- Plywood frame with soy based polyurethane foam.
- Solid maple or walnut legs are standard in ebonized finish but also available in any Nienkämper stains.
- Custom stain is available with upcharge.

# LOUNGE SEATING

BASS Collection Designer - busk + hertzog

— US Only —

Model Number	Seat H"	Arm H"	W"	D"	H"	Fabric		COM	COL	Verde	Grano	Cremoso	Knoll Textiles			
						Yds.	Sq.Ft.						1	2	3	4

## BASS LOW BACK SMALL LOUNGE CHAIR

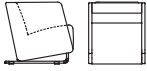

<b>12011</b>	17	26½	27	29	26½	5	90
		seat & back				3	54
		arms				3½	63

3,290	3,460	5,950	6,500	6,775	3,760	4,200	4,665	5,145
-------	-------	-------	-------	-------	-------	-------	-------	-------

## BASS LOW BACK LARGE LOUNGE CHAIR

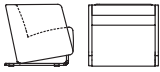

<b>12012</b>	17	26½	32	29	26½	6½	99
		seat & back				3	54
		arms				3½	63

3,405	3,590	6,310	6,915	7,205	4,025	4,590	5,200	5,825
-------	-------	-------	-------	-------	-------	-------	-------	-------

## BASS LOW BACK 2 SEATER SOFA

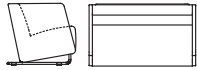

<b>12013</b>	17	26½	59	29	26½	7½	135
		seat & back				5	90
		arms				3½	63

4,565	4,795	7,860	8,540	8,885	5,270	5,925	6,615	7,345
-------	-------	-------	-------	-------	-------	-------	-------	-------

## BASS LOW BACK 3 SEATER SOFA

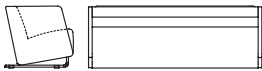

<b>12014</b>	17	26½	82	29	26½	9½	171
		seat & back				7	126
		arms				3½	63

6,335	6,665	10,050	10,800	11,170	7,230	8,060	8,950	9,865
-------	-------	--------	--------	--------	-------	-------	-------	-------

### Standard features:

- Frame is constructed of Solid Maple and FSC Hardwood Plywood with soy-based Polyurethane Foam covered with Fortrel
- Polished chrome tubular base

Model # 12011



Model # 12013



Model # 12014



# LOUNGE SEATING

BASS Collection Designer - busk + hertzog

— US Only —

Model Number	Seat H"	Arm H"	W"	D"	H"	Fabric		COM	COL	Verde	Grano	Cremoso	Knoll Textiles			
						Yds.	Sq.Ft.						1	2	3	4

## BASS HIGH BACK LARGE LOUNGE CHAIR

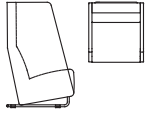

<b>12024</b>	17	46½	32	29	46½	7	126	4,700	4,945	8,105	8,810	9,165	5,370	5,975	6,630	7,305
		seat & back				4½	81									
		arms				5⅓	96									

## BASS HIGH BACK 2 SEATER SOFA

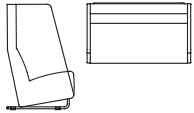

<b>12022</b>	17	46½	59	29	46½	11	198	5,930	6,230	11,210	12,325	12,870	6,970	7,925	8,960	10,015
		seat & back				6¾	122									
		arms				5⅓	96									

## BASS HIGH BACK 3 SEATER SOFA

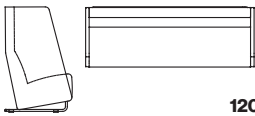

<b>12023</b>	17	46½	82	29	46½	13	234	7,795	8,190	14,080	15,375	16,030	9,015	10,155	11,375	12,625
		seat & back				9	162									
		arms				5⅓	96									

Model # 12022



Model # 12023



### Standard features:

- Frame is constructed of Solid Maple and FSC Hardwood Plywood with soy-based Polyurethane Foam covered with Fortrel
- Polished chrome tubular base

# LOUNGE SEATING

Bay Designer - busk + hertzog

— US Only —

Model Number	Seat H"	W"	D"	H"	Fabric		COM	COL	Neather	Verde	Grano	Cremoso	Knoll Textiles			
					Yds.	Sq.Ft.							1	2	3	4

## BAY CHAIR WITH UPHOLSTERED BASE



<b>10520</b>	16	26	27¼	26¼	3¼	59		2,640	2,780	2,970	4,380	4,700	4,865	2,950	3,235	3,540	3,850		
Fully upholstered																			
<b>10521</b>	Contrasting Fabric								2,640		2,970				2,950	3,235	3,540	3,850	
	Seat																		1¾
	Base																		1½
<b>10522</b>	Contrasting Leather																		
	Seat										2,780		4,380		4,700		4,865		32
	Base																		27

Model # 10521







### Standard features:

- Seat with plywood shell & soy based flexible polyurethane foam
- Base in soy based rigid polyurethane
- Base with plastic glides at bottom.

# LOUNGE SEATING

Beam Collection - Designer - Kenny Nguyen

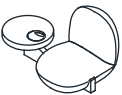
— US Only —

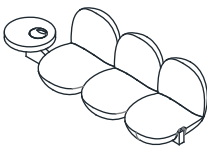
Model Number	Seat H"	W"	D"	H"	Fabric Yds.	Leather Sq.Ft.	COM	COL	Neather	Verde	Grano	Cremoso	Knoll Textiles				
													1	2	3	4	
<b>BEAM LOUNGE CHAIR</b>																	
	<b>14931</b>	16½	28¾	39¾	31	4.5	100	3,340	3,510	3,750	6,110	6,510	7,010	3,540	3,720	3,905	4,105
<b>BEAM 2 SEAT</b>																	
	<b>14932</b>	16½	58¾	39¾	31	9	200	6,680	7,015	7,500	12,215	13,015	14,015	7,080	7,440	7,805	8,205
<b>BEAM 3 SEAT</b>																	
	<b>14933</b>	16½	89	39¾	31	13.5	300	10,020	10,525	11,250	18,325	19,525	21,025	10,615	11,155	11,710	12,305
<b>BEAM CHAIR WITH TABLE</b>																	
	<b>14935</b>	16½	53¾	39¾	31	4.5	100	5,525	5,805	5,935	8,405	8,805	9,305	5,725	5,905	6,090	6,290
<b>BEAM 2 SEAT WITH END TABLE</b>																	
	<b>14936</b>	16½	84	39¾	31	9	200	8,865	9,310	9,685	14,510	15,310	16,310	9,265	9,625	9,990	10,390
<b>BEAM 2 SEAT WITH MID TABLE</b>																	
	<b>14937</b>	16½	84	39¾	31	9	200	8,865	9,310	9,685	14,510	15,310	16,310	9,265	9,625	9,990	10,390
<b>BEAM 3 SEAT WITH END TABLE</b>																	
	<b>14938</b>	16½	114¼	39¾	31	13.5	300	12,205	12,820	13,435	20,620	21,820	23,320	12,800	13,340	13,895	14,490

**Model # 14931**

Beam Lounge Chair  
 Back upholstered in Maharam Nico, 022 Jousting  
 Seat upholstered in Maharam Nico, 021 Rosin

**Model # 14937**

Beam Lounge Chair  
 Upholstered in Maharam Nico, 022 Jousting  
 Rift cut, creamy walnut veneer table and beam finish



**Standard features:**

- Constructed from high resilient foam molded over wood frame
- Structural wood beam available in all standard Veneer, stain and finish
- Tables are standard with courtesy 2 power unit.

# LOUNGE SEATING

Belle Lounge Designer - busk + hertzog

— US Only —

Model Number	Seat H"	W"	D"	H"	Fabric		COM	COL	Neather	Verde	Grano	Cremoso	Knoll Textiles			
					Yds.	Sq. Ft.							1	2	3	4

## BELLE LOUNGE



<b>37101</b>	16	33	28	30	4	72	3,005	3,160	3,370	4,985	5,330	5,505	3,385	3,730	4,110	4,490
	Inside Back & Seat Cushion				2	36										
	Outside Back and Bottom				2½	45										

Model # 37101



### Standard features:

- Frame: Durable construction with steel frame covered with molded foam
- Cushion: High resistant and flexible foam on seat cushion
- Base: Swivel brushed metal disc base as standard, fixed disc base is also an option.
- Base Finishes: Brushed black, brushed silver and powder coat finishes also available.



# LOUNGE SEATING

The Berkley® Collection Designer - Nienkämper

— US Only —

Model Number	Seat H"	W"	D"	H"	Fabric Yds.	Leather Sq. Ft.	COM	COL	Neather	Verde	Grano	Cremoso	Knoll Textiles			
													1	2	3	4

## SINGLE ELEMENT



Model #	Seat H"	W"	D"	H"	Fabric Yds.	Leather Sq. Ft.
<b>13410_</b>	16	24	35	27½		
/1	Armless with metal legs				3 ¾	60
/2	8 Angled arm				5 ½	88
/3	10 Angled arm				6 ¼	100
/4	8 Straight arm with leg				5 ½	88
/5	10 Straight arm with leg				6 ¼	100

Note: Width measurements do not include arms.

<b>3,145</b>	<b>3,380</b>	<b>3,390</b>	<b>4,515</b>	<b>4,890</b>	<b>5,040</b>	<b>3,505</b>	<b>3,830</b>	<b>4,180</b>	<b>4,545</b>
4,040	4,335	4,560	6,940	7,710	8,025	4,565	5,035	5,555	6,085
<b>4,160</b>	<b>4,470</b>	<b>4,695</b>	<b>7,100</b>	<b>7,845</b>	<b>8,155</b>	<b>4,760</b>	<b>5,295</b>	<b>5,890</b>	<b>6,485</b>
5,415	5,810	5,865	7,855	8,515	8,765	5,935	6,415	6,925	7,455
<b>5,475</b>	<b>5,870</b>	<b>5,920</b>	<b>7,915</b>	<b>8,565</b>	<b>8,820</b>	<b>6,065</b>	<b>6,605</b>	<b>7,195</b>	<b>7,800</b>

## TWO SEAT ELEMENT

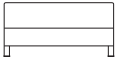

Model #	Seat H"	W"	D"	H"	Fabric Yds.	Leather Sq. Ft.
<b>13401_</b>	16	48	35	27½		
/1	Armless with metal legs				3 ¾	60
/2	8 Angled arm				5 ½	88
/3	10 Angled arm				6 ¼	100
/4	8 Straight arm with leg				5 ½	88
/5	10 Straight arm with leg				6 ¼	100

Note: Width measurements do not include arms.

<b>4,075</b>	<b>4,380</b>	<b>4,500</b>	<b>6,380</b>	<b>6,980</b>	<b>7,215</b>	<b>4,440</b>	<b>4,765</b>	<b>5,110</b>	<b>5,475</b>
4,965	5,335	5,655	8,795	9,800	10,210	5,485	5,965	6,480	7,005
<b>5,100</b>	<b>5,485</b>	<b>5,795</b>	<b>8,945</b>	<b>9,950</b>	<b>10,360</b>	<b>5,695</b>	<b>6,235</b>	<b>6,815</b>	<b>7,425</b>
6,340	6,805	6,950	9,715	10,615	10,970	6,865	7,335	7,855	8,380
<b>6,395</b>	<b>6,890</b>	<b>7,005</b>	<b>9,785</b>	<b>10,665</b>	<b>11,020</b>	<b>6,990</b>	<b>7,535</b>	<b>8,120</b>	<b>8,730</b>

## LARGE TWO SEAT ELEMENT

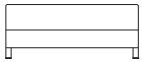

Model #	Seat H"	W"	D"	H"	Fabric Yds.	Leather Sq. Ft.
<b>13402_</b>	16	60	35	27½		
/1	Armless with metal legs				4 ¼	68
/2	8 Angled arm				6	96
/3	10 Angled arm				6 ¾	108
/4	8 Straight arm with leg				6	96
/5	10 Straight arm with leg				6 ¾	108

Note: Width measurements do not include arms.

<b>4,350</b>	<b>4,675</b>	<b>4,825</b>	<b>6,950</b>	<b>7,650</b>	<b>7,915</b>	<b>4,760</b>	<b>5,125</b>	<b>5,525</b>	<b>5,930</b>
5,245	5,625	5,995	9,385	10,470	10,900	5,815	6,340	6,900	7,480
<b>5,375</b>	<b>5,785</b>	<b>6,125</b>	<b>9,525</b>	<b>10,615</b>	<b>11,045</b>	<b>6,015</b>	<b>6,595</b>	<b>7,230</b>	<b>7,885</b>
6,615	7,115	7,310	10,305	11,275	11,640	7,190	7,710	8,270	8,855
<b>6,685</b>	<b>7,180</b>	<b>7,345</b>	<b>10,365</b>	<b>11,320</b>	<b>11,725</b>	<b>7,325</b>	<b>7,910</b>	<b>8,545</b>	<b>9,195</b>

Berkley Collection passes CAL 133 certified for an upcharge of \$435 list per single element, \$870 list per 2 seat element, and \$1,095 list per large 2 seat element. Certification applies to Nienkämper leathers and fabrics that have a minimum of 50% natural fibre content. COM's and COL's are subject to approval. Add the extension -CAL to the model number when ordering.



Model # 1  
Armless

Model # 2  
8 Angled Arm

Model # 3  
10 Angled Arm

Model # 4  
8 Angled Arm

Model # 5  
10 Angled Arm



# LOUNGE SEATING

The Berkley® Collection Designer – Nienkämper

— US Only —

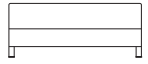
Model Number	Seat H"	W"	D"	H"	Fabric Yds.	Leather Sq. Ft.	COM	COL	Neather	Verde	Grano	Cremoso	Knoll Textiles						
													1	2	3	4			
<b>THREE SEAT ELEMENT</b>																			
	<b>13403_</b>	16	72	35	27½														
	<b>/1</b>	Armless with metal legs				5	80	<b>4,715</b>	<b>5,085</b>	<b>5,280</b>	<b>7,795</b>	<b>8,595</b>	<b>8,915</b>	<b>5,195</b>	<b>5,625</b>	<b>6,100</b>	<b>6,575</b>		
	<b>/2</b>	8 Angled arm				6¾	108	5,605	6,015	6,455	10,205	11,410	11,920	6,245	6,835	7,465	8,115		
	<b>/3</b>	10 Angled arm				7½	120	<b>5,745</b>	<b>6,170</b>	<b>6,575</b>	<b>10,350</b>	<b>11,545</b>	<b>12,040</b>	<b>6,450</b>	<b>7,095</b>	<b>7,790</b>	<b>8,500</b>		
	<b>/4</b>	8 Straight arm with leg				6¾	108	6,980	7,485	7,750	11,125	12,210	12,645	7,625	8,210	8,840	9,495		
	<b>/5</b>	10 Straight arm with leg				7½	120	<b>7,050</b>	<b>7,560</b>	<b>7,800</b>	<b>11,185</b>	<b>12,270</b>	<b>12,715</b>	<b>7,755</b>	<b>8,415</b>	<b>9,110</b>	<b>9,835</b>		

Note: Width measurements do not include arms.

## LARGE THREE SEAT ELEMENT

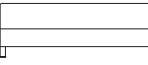
	<b>13404_</b>	16	84	35	27½														
	<b>/1</b>	Armless with metal legs				5 ¾	92	<b>5,195</b>	<b>5,575</b>	<b>5,825</b>	<b>8,735</b>	<b>9,645</b>	<b>10,010</b>	<b>5,735</b>	<b>6,235</b>	<b>6,775</b>	<b>7,330</b>		
	<b>/2</b>	8 Angled arm				7½	120	6,090	6,530	6,985	11,130	12,470	13,010	6,795	7,450	8,150	8,875		
	<b>/3</b>	10 Angled arm				8¼	132	<b>6,215</b>	<b>6,685</b>	<b>7,130</b>	<b>11,280</b>	<b>12,610</b>	<b>13,155</b>	<b>6,990</b>	<b>7,710</b>	<b>8,480</b>	<b>9,280</b>		
	<b>/4</b>	8 Straight arm with leg				7½	120	7,450	8,015	8,305	12,050	13,265	13,765	8,160	8,810	9,515	10,240		
	<b>/5</b>	10 Straight arm with leg				8¼	132	<b>7,525</b>	<b>8,070</b>	<b>8,350</b>	<b>12,115</b>	<b>13,325</b>	<b>13,815</b>	<b>8,305</b>	<b>9,020</b>	<b>9,795</b>	<b>10,585</b>		

Note: Width measurements do not include arms.

**Berkley Collection passes CAL 133 certified for an upcharge of \$1,305 list per 3 seat element, and \$1,535 per large 3 seat element. Certification applies to Nienkämper leathers and fabrics that have a minimum of 50% natural fibre content. COM's and COL's are subject to approval. Add the extension -CAL to the model number when ordering.**

The Berkley Collection is a Nienkämper classic in its contemporary style and simplicity of line. This is a collection that is elegant yet generous in proportions. Berkley works well in public spaces, executive lounges, lobbies, and residences.

**Frame:**  
Solid maple and plywood construction.

**Seat and Back:**  
The seat and back are polyurethane foam covered in Fortrel®. Upholstered in leather or fabric. Yardages are for plain non-directional fabrics. Fabrics are railroaded.

**Arms:**  
Two arm options are available, Angled and Straight. The Angled arm carries to the floor. The Straight arm rests on an aluminum base.

**Base:**  
On models with Angled arms, the base is solid maple runners painted matte black. Aluminum bases are available in a brushed, polished, or painted finish.

**Model # 1** Armless    **Model # 2** 8 Angled Arm    **Model # 3** 10 Angled Arm    **Model # 4** 8 Angled Arm    **Model # 5** 10 Angled Arm



# LOUNGE SEATING

The Berkley® Collection Designer - Nienkämper

— US Only —

Model Number	Seat H"	W"	D"	H"	Fabric Yds.	Leather Sq. Ft.	COM	COL	Neather	Verde	Grano	Cremoso	Knoll Textiles					
													1	2	3	4		
<b>FOUR SEAT ELEMENT</b>																		
 <b>13405_</b>	16	96	35	27½														
<b>/1</b> Armless with metal legs					6¼	100	<b>5,810</b>	<b>6,240</b>	<b>6,505</b>	<b>9,645</b>	<b>10,660</b>	<b>11,070</b>	<b>6,395</b>	<b>6,945</b>	<b>7,530</b>	<b>8,130</b>		
<b>/2</b> 8 Angled arm					8	128	6,700	7,190	7,660	12,055	13,495	14,045	7,455	8,155	8,905	9,680		
<b>/3</b> 10 Angled arm					8 ¾	140	<b>6,860</b>	<b>7,340</b>	<b>7,805</b>	<b>12,205</b>	<b>13,620</b>	<b>14,170</b>	<b>7,685</b>	<b>8,445</b>	<b>9,260</b>	<b>10,110</b>		
<b>/4</b> 8 Straight arm with leg					8	128	8,070	8,675	8,975	12,985	14,290	14,795	8,820	9,525	10,275	11,050		
<b>/5</b> 10 Straight arm with leg					8 ¾	140	<b>8,130</b>	<b>8,740</b>	<b>9,030</b>	<b>13,050</b>	<b>14,350</b>	<b>14,850</b>	<b>8,965</b>	<b>9,725</b>	<b>10,540</b>	<b>11,390</b>		

Note: Width measurements do not include arms.

## LARGE FOUR SEAT ELEMENT

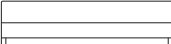
 <b>13418_</b>	16	108	35	27½														
<b>/1</b> Armless with metal legs					7	112	<b>6,480</b>	<b>6,945</b>	<b>7,240</b>	<b>10,760</b>	<b>11,895</b>	<b>12,345</b>	<b>7,140</b>	<b>7,750</b>	<b>8,410</b>	<b>9,080</b>		
<b>/2</b> 8 Angled arm					8¾	140	7,360	7,910	8,425	13,195	14,740	15,340	8,190	8,955	9,765	10,620		
<b>/3</b> 10 Angled arm					9½	152	<b>7,515</b>	<b>8,050</b>	<b>8,550</b>	<b>13,325</b>	<b>14,860</b>	<b>15,480</b>	<b>8,410</b>	<b>9,225</b>	<b>10,110</b>	<b>11,015</b>		
<b>/4</b> 8 Straight arm with leg					8¾	140	8,740	9,385	9,715	14,110	15,515	16,090	9,565	10,325	11,140	11,990		
<b>/5</b> 10 Straight arm with leg					9½	152	<b>8,790</b>	<b>9,450</b>	<b>9,780</b>	<b>14,160</b>	<b>15,580</b>	<b>16,140</b>	<b>9,690</b>	<b>10,520</b>	<b>11,405</b>	<b>12,325</b>		

Note: Width measurements do not include arms.

**Berkley Collection passes CAL 133 certified for an upcharge of \$1,755 list per 4 seat element, and \$1,975 per large 4 seat element. Certification applies to Nienkämper leathers and fabrics that have a minimum of 50% natural fibre content. COM's and COL's are subject to approval. Add the extension -CAL to the model number when ordering.**

The Berkley Collection is a Nienkämper classic in its contemporary style and simplicity of line. This is a collection that is elegant yet generous in proportions. Berkley works well in public spaces, executive lounges, lobbies, and residences.

### Frame:

Solid maple and plywood construction.

### Seat and Back:

The seat and back are polyurethane foam covered in Fortrel®. Upholstered in leather or fabric. Yardages are for plain non-directional fabrics. Fabrics are railroaded.

### Arms:

Two arm options are available, Angled and Straight. The Angled arm carries to the floor. The Straight arm rests on an aluminum base.

### Base:

On models with Angled arms, the base is solid maple runners painted matte black. Aluminum bases are available in a brushed, polished, or painted finish.

**Model # 1 Armless**      **Model # 2 8 Angled Arm**      **Model # 3 10 Angled Arm**      **Model # 4 8 Angled Arm**      **Model # 5 10 Angled Arm**



# LOUNGE SEATING



The Berkley® Collection Designer – Nienkämper

— US Only —

Model Number	Seat H"	W"	D"	H"	Fabric Yds.	Leather Sq.Ft.	COM	COL	Neather	Verde	Grano	Cremoso	Knoll Textiles						
													1	2	3	4			
<b>FIVE SEAT ELEMENT</b>																			
	<b>13419</b>	16	120	35	27½														
/1	Armless with metal legs				7 ¾	139½	<b>7,135</b>	<b>7,660</b>	<b>8,020</b>	<b>11,895</b>	<b>13,155</b>	<b>13,640</b>	<b>7,870</b>	<b>8,550</b>	<b>9,275</b>	<b>10,015</b>			
/2	8 Angled arm				9 ½	152	8,030	8,630	9,170	14,310	15,975	16,630	8,925	9,755	10,645	11,565			
/3	10 Angled arm				10 ¼	164	<b>8,160</b>	<b>8,775</b>	<b>9,310</b>	<b>14,445</b>	<b>16,120</b>	<b>16,780</b>	<b>9,130</b>	<b>10,020</b>	<b>10,980</b>	<b>11,970</b>			
/4	8 Straight arm with leg				9 ½	152	9,410	10,105	10,475	15,250	16,780	17,385	10,310	11,130	12,020	12,945			
/5	10 Straight arm with leg				10 ¼	164	<b>9,465</b>	<b>10,175</b>	<b>10,530</b>	<b>15,290</b>	<b>16,830</b>	<b>17,445</b>	<b>10,440</b>	<b>11,325</b>	<b>12,285</b>	<b>13,280</b>			

Note: Width measurements do not include arms.

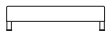
## BENCH

	<b>13411</b>	16	48	24	16	2 ¼	32	<b>2,110</b>	<b>2,250</b>	<b>2,320</b>	<b>3,340</b>	<b>3,635</b>	<b>3,775</b>	<b>2,320</b>	<b>2,510</b>	<b>2,720</b>	<b>2,940</b>		
	<b>13412</b>	16	60	24	16	2 ¾	40	2,160	2,310	2,405	3,545	3,900	4,050	2,415	2,665	2,920	3,180		
	<b>13413</b>	16	72	24	16	3 ¼	48	<b>2,520</b>	<b>2,710</b>	<b>2,800</b>	<b>4,055</b>	<b>4,465</b>	<b>4,610</b>	<b>2,825</b>	<b>3,115</b>	<b>3,420</b>	<b>3,730</b>		
	<b>13414</b>	16	84	24	16	3 ¾	56	3,255	3,505	3,570	4,955	5,385	5,565	3,615	3,935	4,285	4,655		
	<b>13415</b>	16	96	24	16	4 ¼	64	<b>3,445</b>	<b>3,690</b>	<b>3,775</b>	<b>5,280</b>	<b>5,760</b>	<b>5,940</b>	<b>3,845</b>	<b>4,220</b>	<b>4,610</b>	<b>5,020</b>		

Note: Width measurements do not include arms.

**Berkley Collection passes CAL 133 certified for an upcharge of \$2,195 list per 5 seat element, \$505 list per 48 bench, \$630 list per 60 bench, \$760 list per 72 bench, \$890 list per 84 bench, and \$1010 list per 96 bench. Certification applies to Nienkämper leathers and fabrics that have a minimum of 50% natural fibre content. COM's and COL's are subject to approval. Add the extension -CAL to the model number when ordering.**

The Berkley Collection is a Nienkämper classic in its contemporary style and simplicity of line. This is a collection that is elegant yet generous in proportions. Berkley works well in public spaces, executive lounges, lobbies, and residences.

### Frame:

Solid maple and plywood construction.

### Seat and Back:

The seat and back are polyurethane foam covered in Fortrel®. Upholstered in leather or fabric. Yardages are for plain non-directional fabrics. Fabrics are railroaded.

### Arms:

Two arm options are available, Angled and Straight. The Angled arm carries to the floor. The Straight arm rests on an aluminum base.

### Base:

On models with Angled arms, the base is solid maple runners painted matte black. Aluminum bases are available in a brushed, polished, or painted finish.

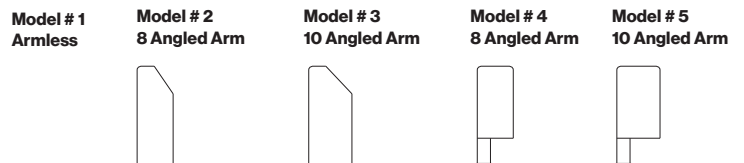

# LOUNGE SEATING

The Berkley® Collection Designer - Nienkämper

— US Only —

Model Number	Seat H"	W"	D"	H"	Fabric Yds.	Leather Sq.Ft.	COM	COL	Neather	Verde	Grano	Cremoso	Knoll Textiles			
													1	2	3	4

## LEFT CORNER ELEMENTS

<b>One Seat Left Element</b>																
13421_	16	23½-58½	35	27½												
/1	Armless with metal legs				4¼	68	<b>3,545</b>	<b>3,805</b>	<b>4,025</b>	<b>6,140</b>	<b>6,860</b>	<b>7,110</b>	<b>3,945</b>	<b>4,320</b>	<b>4,710</b>	<b>5,125</b>
/2	8 Angled arm				5	80	3,965	4,270	4,585	7,300	8,135	8,485	4,445	4,880	5,345	5,825
/3	10 Angled arm				5½	86	<b>4,050</b>	<b>4,350</b>	<b>4,650</b>	<b>7,340</b>	<b>8,225</b>	<b>8,560</b>	<b>4,575</b>	<b>5,050</b>	<b>5,565</b>	<b>6,100</b>
/4	8 Straight arm with leg				5	80	4,670	5,010	5,235	7,750	8,550	8,865	5,140	5,580	6,040	6,530
/5	10 Straight arm with leg				5½	86	<b>4,700</b>	<b>5,050</b>	<b>5,260</b>	<b>7,770</b>	<b>8,570</b>	<b>8,890</b>	<b>5,225</b>	<b>5,705</b>	<b>6,220</b>	<b>6,750</b>

Note: Width measurements do not include arms. One arm and one element must be specified with each element ordered

<b>Two Seat Left Element</b>																
13422_	16	47¼-82½	35	27½												
/1	Armless with metal legs				5¾	92	<b>4,470</b>	<b>4,805</b>	<b>5,110</b>	<b>8,000</b>	<b>8,945</b>	<b>9,305</b>	<b>5,015</b>	<b>5,515</b>	<b>6,050</b>	<b>6,605</b>
/2	8 Angled arm				6½	104	4,905	5,280	5,685	9,135	10,240	10,685	5,525	6,090	6,695	7,325
/3	10 Angled arm				7	110	<b>4,990</b>	<b>5,365</b>	<b>5,755</b>	<b>9,195</b>	<b>10,310</b>	<b>10,755</b>	<b>5,650</b>	<b>6,260</b>	<b>6,910</b>	<b>7,590</b>
/4	8 Straight arm with leg				6½	104	5,605	6,015	6,330	9,595	10,650	11,070	6,220	6,785	7,400	8,025
/5	10 Straight arm with leg				7	110	<b>5,625</b>	<b>6,065</b>	<b>6,365</b>	<b>9,620</b>	<b>10,665</b>	<b>11,085</b>	<b>6,295</b>	<b>6,900</b>	<b>7,550</b>	<b>8,230</b>

Note: Width measurements do not include arms. One arm and one element must be specified with each element ordered

<b>Three Seat Left Element</b>																
13423_	16	71½-106½	35	27½												
/1	Armless with metal legs				7¼	116	<b>5,105</b>	<b>5,490</b>	<b>5,925</b>	<b>9,555</b>	<b>10,730</b>	<b>11,200</b>	<b>5,795</b>	<b>6,425</b>	<b>7,100</b>	<b>7,805</b>
/2	8 Angled arm				8	128	5,560	5,970	6,490	10,695	12,040	12,590	6,320	7,015	7,760	8,540
/3	10 Angled arm				8½	134	<b>5,620</b>	<b>6,040</b>	<b>6,555</b>	<b>10,760</b>	<b>11,925</b>	<b>12,650</b>	<b>6,430</b>	<b>7,165</b>	<b>7,965</b>	<b>8,780</b>
/4	8 Straight arm with leg				8	128	6,240	6,710	7,135	11,165	12,440	12,960	6,995	7,695	8,445	9,215
/5	10 Straight arm with leg				8½	134	<b>6,280</b>	<b>6,740</b>	<b>7,165</b>	<b>11,185</b>	<b>12,490</b>	<b>12,985</b>	<b>7,090</b>	<b>7,825</b>	<b>8,625</b>	<b>9,435</b>

Note: Width measurements do not include arms. One arm and one element must be specified with each element ordered

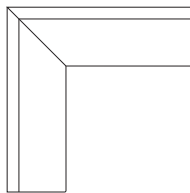
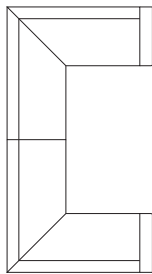

Model # 1  
Armless



Model # 2  
8 Angled Arm



Model # 3  
10 Angled Arm



Model # 4  
8 Angled Arm



Model # 5  
10 Angled Arm

Yardages are for plain non-directional fabrics. Fabrics are railroaded. COM must be approved before placing an order.

# LOUNGE SEATING

The Berkley® Collection Designer – Nienkämper

— US Only —

Model Number	Seat H"	W"	D"	H"	Fabric Yds.	Leather Sq.Ft.	Knoll Textiles											
							COM	COL	Neather	Verde	Grano	Cremoso	1	2	3	4		

## RIGHT CORNER ELEMENTS



### One Seat Right Element

Model #	Seat H"	W"	D"	H"	Fabric Yds.	Leather Sq.Ft.	COM	COL	Neather	Verde	Grano	Cremoso	1	2	3	4	
<b>13424_</b>	16	23½-58½	35	27½													
/1	Armless with metal legs				4¼	68	<b>3,545</b>	<b>3,805</b>	<b>4,025</b>	<b>6,140</b>	<b>6,860</b>	<b>7,110</b>	<b>3,945</b>	<b>4,320</b>	<b>4,710</b>	<b>5,125</b>	
/2	8 Angled arm				5	80	3,965	4,270	4,585	7,300	8,135	8,485	4,445	4,880	5,345	5,825	
/3	10 Angled arm				5½	86	<b>4,050</b>	<b>4,350</b>	<b>4,650</b>	<b>7,340</b>	<b>8,225</b>	<b>8,560</b>	<b>4,575</b>	<b>5,050</b>	<b>5,565</b>	<b>6,100</b>	
/4	8 Straight arm with leg				5	80	4,670	5,010	5,235	7,750	8,550	8,865	5,140	5,580	6,040	6,530	
/5	10 Straight arm with leg				5½	86	<b>4,700</b>	<b>5,050</b>	<b>5,260</b>	<b>7,770</b>	<b>8,570</b>	<b>8,890</b>	<b>5,225</b>	<b>5,705</b>	<b>6,220</b>	<b>6,750</b>	



### Two Seat Right Element

Model #	Seat H"	W"	D"	H"	Fabric Yds.	Leather Sq.Ft.	COM	COL	Neather	Verde	Grano	Cremoso	1	2	3	4	
<b>13425_</b>	16	47½-82½	35	27½													
/1	Armless with metal legs				5¾	92	<b>4,470</b>	<b>4,805</b>	<b>5,110</b>	<b>8,000</b>	<b>8,945</b>	<b>9,305</b>	<b>5,015</b>	<b>5,515</b>	<b>6,050</b>	<b>6,605</b>	
/2	8 Angled arm				6½	104	4,905	5,280	5,685	9,135	10,240	10,685	5,525	6,090	6,695	7,325	
/3	10 Angled arm				7	110	<b>4,990</b>	<b>5,365</b>	<b>5,755</b>	<b>9,195</b>	<b>10,310</b>	<b>10,755</b>	<b>5,650</b>	<b>6,260</b>	<b>6,910</b>	<b>7,590</b>	
/4	8 Straight arm with leg				6½	104	5,605	6,015	6,330	9,595	10,650	11,070	6,220	6,785	7,400	8,025	
/5	10 Straight arm with leg				7	110	<b>5,625</b>	<b>6,065</b>	<b>6,365</b>	<b>9,620</b>	<b>10,665</b>	<b>11,085</b>	<b>6,295</b>	<b>6,900</b>	<b>7,550</b>	<b>8,230</b>	

Note: Width measurements do not include arms. One arm and one element must be specified with each element ordered



### Three Seat Right Element

Model #	Seat H"	W"	D"	H"	Fabric Yds.	Leather Sq.Ft.	COM	COL	Neather	Verde	Grano	Cremoso	1	2	3	4	
<b>13426_</b>	16	71½-106½	35	27½													
/1	Armless with metal legs				7¼	116	<b>5,105</b>	<b>5,490</b>	<b>5,925</b>	<b>9,555</b>	<b>10,730</b>	<b>11,200</b>	<b>5,795</b>	<b>6,425</b>	<b>7,100</b>	<b>7,805</b>	
/2	8 Angled arm				8	128	5,560	5,970	6,490	10,695	12,040	12,590	6,320	7,015	7,760	8,540	
/3	10 Angled arm				8½	134	<b>5,620</b>	<b>6,040</b>	<b>6,555</b>	<b>10,760</b>	<b>11,925</b>	<b>12,650</b>	<b>6,430</b>	<b>7,165</b>	<b>7,965</b>	<b>8,780</b>	
/4	8 Straight arm with leg				8	128	6,240	6,710	7,135	11,165	12,440	12,960	6,995	7,695	8,445	9,215	
/5	10 Straight arm with leg				8½	134	<b>6,280</b>	<b>6,740</b>	<b>7,165</b>	<b>11,185</b>	<b>12,490</b>	<b>12,985</b>	<b>7,090</b>	<b>7,825</b>	<b>8,625</b>	<b>9,435</b>	

Note: Width measurements do not include arms. One arm and one element must be specified with each element ordered

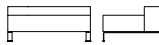

### Bench w/8 Arm

Model #	Seat H"	W"	D"	H"	Fabric Yds.	Leather Sq.Ft.	COM	COL	Neather	Verde	Grano	Cremoso	1	2	3	4
<b>13416</b>		48	32	21½	4	72	<b>4,575</b>	<b>4,800</b>	<b>4,955</b>	<b>6,690</b>	<b>7,385</b>	<b>7,610</b>	<b>4,955</b>	<b>5,295</b>	<b>5,670</b>	<b>6,055</b>

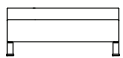

### Bench w/10 Arm

Model #	Seat H"	W"	D"	H"	Fabric Yds.	Leather Sq.Ft.	COM	COL	Neather	Verde	Grano	Cremoso	1	2	3	4
<b>13417</b>		48	34	21½	4	72	4,645	4,870	5,010	6,745	7,450	7,690	5,020	5,370	5,745	6,130



### Movable Cushion

Model #	Seat H"	W"	D"	H"	Fabric Yds.	Leather Sq.Ft.	COM	COL	Neather	Verde	Grano	Cremoso	1	2	3	4
<b>13430</b>		24	12	12	1	18	<b>900</b>	<b>910</b>	<b>1,015</b>	<b>1,435</b>	<b>1,615</b>	<b>1,665</b>	<b>995</b>	<b>1,080</b>	<b>1,180</b>	<b>1,275</b>

Model # 1  
Armless



Model # 2  
8 Angled Arm



Model # 3  
10 Angled Arm



Model # 4  
8 Angled Arm







Model # 5  
10 Angled Arm

# LOUNGE SEATING

Bern Designer – Nienkämper

— US Only —

Model Number	Seat		Arm H"	W"	D"	H"	Fabric Yds.	Leather Sq.Ft.	COM	COL	Neather	Verde	Grano	Cremoso	Knoll Textiles			
	H"	H"													1	2	3	4
<b>SMALL LOUNGE CHAIR</b>																		
 <b>10160</b>	16¼	27¾	33	29	27¾	4	72		3,930	4,140	4,340	6,135	6,520	6,705	4,315	4,660	5,030	5,420
<b>LARGE LOUNGE CHAIR</b>																		
 <b>10161</b>	16¼	27¾	37	29	27¾	4½	81		4,165	4,380	4,610	6,615	7,050	7,265	4,595	4,990	5,405	5,840
<b>TWO SEAT SOFA</b>																		
 <b>10162</b>	16¼	27¾	61	29	27¾	6	108		5,790	6,085	6,370	9,070	9,340	9,920	6,355	6,880	7,440	8,020
<b>THREE SEAT SOFA</b>																		
 <b>10163</b>	16¼	27¾	85	29	27¾	7	126		7,540	7,920	8,230	11,410	11,685	12,460	8,210	8,810	9,465	10,140
<b>THROW CUSHION</b>																		
 <b>10164</b>			12	12		½	9		285	295	330	570	640	685	335	375	430	475

**Model # 10161**

Bern Lounge Chair upholstered in Cremoso leather, Black CM795



**Model # 10163**  
Bern 3 Seat Sofa





**Standard Features:**

- Seat depth: 22"d
- Frame is constructed of Solid Maple and Plywood with soy based Polyurethane Foam covered with Fortrel.
- Square tubular or round legs made of cast aluminum are available in brushed finish. A polished finish is available for an upcharge of \$140 list per chair or sofa.

# LOUNGE SEATING

Blob™ Designer - karim rashid

— US Only —

Model Number	Seat H"	W"	D"	H"	Fabric		Leather				Knoll Textiles				
					Yds.	Sq.Ft.	COM	COL	Verde	Grano	Cremoso	1	2	3	4
<b>BLOB</b>															
	1490__ 16	26	32½	29											
	(Model #1) Fully Upholstered				2¾	50	2,095	2,190	3,585	3,965	4,140	2,360	2,595	2,860	3,120
	(Model #4) Contrasting fabric	sides			1½		2,095					2,240	2,370	2,510	2,665
			seat/back		1½										
	(Model #5) Contrasting leather	sides			27										
		seat/back			27										
<b>BLOB TWO SEAT SOFA</b>															
	16	52	32½	29											
	14908 Fully Upholstered				4¾	86	3,735	3,930	5,810	6,355	6,575	4,185	4,600	5,040	5,505
	14909 Contrasting fabric	sides			1½		3,735					3,880	4,015	4,150	4,295
		seat/back			3¼										
	14910 Contrasting leather	sides			27										
		seat/back			59										
<b>BLOB THREE SEAT SOFA</b>															
	16	78	32½	29											
	14921 Fully Upholstered				6½	117	5,205	5,475	8,060	8,810	9,100	5,840	6,430	7,060	7,710
	14922 Contrasting fabric	sides			1½		5,205					5,345	5,475	5,615	5,765
		seat/back			5										
	14923 Contrasting leather	sides			27										
		seat/back			90		5,475	8,060	8,810	9,100					

The curvaceous shape and soft molded foam of the Blob is conducive to fabrics with some stretch and minimum pattern.

When upholstered in two different fabrics or leathers, use the COM price and ship your fabric yardage or leather square footage to Nienkämper. See page 6 for COM and COL details.

Seams can have matching or contrasting stitching. Matching or contrasting welting detail can also be specified.

\*For patterned or directional fabrics please contact Customer Service at 800.668.9318 for yardages.

Fabric to be upholstered on Blob requires approval from Nienkämper's factory. Please contact customer service at 800 668 9318 for our fabric approval list.

**Model #14904**  
Contrasting fabric



**Model #14904**  
Contrasting fabric





# LOUNGE SEATING

Bloor® Collection Designer – Nienkämper

— US Only —

Model Number	Seat H"	Arm H"	W"	D"	H"	Fabric Yds.	Leather Sq. Ft.	COM	COL	Verde	Grano	Cremoso	Knoll Textiles			
													1	2	3	4

## CHAIR



<b>13481</b>	16	24	34	29	27½	4	74	4,035	4,340	6,300	6,900	7,130	4,410	4,765	5,135	5,525
--------------	----	----	----	----	-----	---	----	-------	-------	-------	-------	-------	-------	-------	-------	-------

## TWO SEAT SOFA

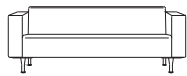

<b>13482</b>	16	24	72	29	27½	6	110	4,500	4,825	7,605	8,435	8,760	5,070	5,595	6,155	6,740
--------------	----	----	----	----	-----	---	-----	-------	-------	-------	-------	-------	-------	-------	-------	-------

## THREE SEAT SOFA

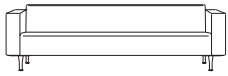

<b>13483</b>	16	24	90	29	27½	7½	140	5,995	6,460	9,810	10,825	11,225	6,700	7,350	8,050	8,780
--------------	----	----	----	----	-----	----	-----	-------	-------	-------	--------	--------	-------	-------	-------	-------



The frame is a laminated wood base frame with tubular steel support under the fixed cushion.

The seat and back are polyurethane foam. The seat foam is covered in Fortrel®. Upholstered in leather or fabric. Tufted seat when upholstered in leather. Back can be tufted if desired.





Laminated wood base frame with tubular steel support under the fixed cushion. The legs are solid aluminum in a brushed finish.



# LOUNGE SEATING

Carlisle Designer - George Yabu & Glenn Pushelburg

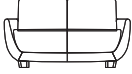
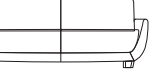
— US Only —

Model Number	Seat H"	Arm H"	W"	D"	H"	Fabric Yds.	Leather Sq.Ft.	Knoll Textiles															
								COM	COL	Neather	Verde	Grano	Cremoso	1	2	3	4						
<b>CHAIR WITH SWIVEL DISK</b>																							
	<b>16200</b>	16 ½	22	33	29	29																	
	COM cushions & frame	1¾ yds	¾ yds																				
	Fully upholstered						4 ½	75	3,440	3,610	3,930	6,240	6,970	7,290	3,860	4,255	4,675	5,110					
	COM seat & back cushions, leather frame						1¾	53		3,610	3,620	5,420	5,935	6,140									
<b>CHAIR WITH SWIVEL PEDESTAL BASE</b>																							
	<b>16240</b>	19	24 ½	33	29	32																	
	COM cushions & frame	1¾ yds	¾ yds																				
	Fully upholstered						4 ½	75	3,770	3,950	4,220	6,370	7,090	7,345	4,200	4,590	5,010	5,445					
	COM seat & back cushions, leather frame						1¾	53		3,950	3,960	5,455	5,900	6,075									
<b>CHAIR WITH LEGS</b>																							
	<b>16210</b>	16 ½	22	33	29	29																	
	COM cushions & frame	1¾ yds	¾ yds																				
	Fully upholstered						4	70	3,440	3,610	3,880	6,040	6,740	6,995	3,820	4,160	4,540	4,920					
	COM seat & back cushions, leather frame						1¾	45		3,610	3,620	5,115	5,560	5,730									
<b>TWO SEAT SOFA</b>																							
	<b>16220</b>	16 ½	22	56 ¾	29	29																	
	COM cushions & frame	3½ yds	¾ yds																				
	Fully upholstered						7	104	5,940	6,240	6,740	9,840	10,865	11,280	6,600	7,215	7,865	8,545					
	COM seat & back cushions, leather frame						3½	63		6,240	6,340	8,310	8,935	9,180									
<b>THREE SEAT SOFA</b>																							
	<b>16230</b>	16 ½	22	79 ¾	29	29																	
	COM cushions & frame	5¼ yds	5¼ yds																				
	Fully upholstered						10	136	8,780	9,220	9,905	13,890	15,210	15,745	9,725	10,595	11,525	12,490					
	COM seat & back cushions, leather frame						5¼	81		9,220	9,375	11,825	12,615	12,940									
<b>OTTOMAN</b>																							
	<b>16250</b>	24 ½			20	16	1 ½	25	2,190	2,305	2,335	3,140	3,375	3,475	2,330	2,440	2,565	2,690					

**Carlisle series passes CAL 133 certified for an upcharge of \$435 list per chair, \$870 list per two seater sofa, \$1305 list per three seat sofa, and \$380 list per ottoman. Certification applies to Nienkämper leathers and fabrics that have a minimum of 50% natural fibre content. COM's and COL's are subject to approval. Add the extension -CAL to the model number when ordering.**

Legs and swivel disk base are upholstered to match the frame.

Swivel pedestal base is in brushed nickel finish.

When upholstered in leather, the two seat sofa (model 16220) has a center seam. When upholstered in fabric, the two seat sofa (model 16220) does not have a center seam.

When upholstering in two different fabrics, use the COM price and ship yardages as noted on page 6.

**Model #16200**  
Fully upholstered



**Model #16240**  
Fully upholstered in Grano leather G7084 Basalt



# LOUNGE SEATING

COCOON Designer – Mark Saffell and David Ritch

— US Only —

Model Number	Seat H"	W"	D"	H"	Fabric Yds.	Leather Sq.Ft.	COM	COL	Verde	Grano	Cremoso	Knoll Textiles			
												1	2	3	4

## UPHOLSTERED SEAT

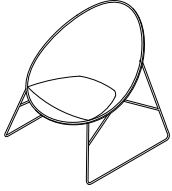

10901	17	30	30	35½	¾	10	1,150	1,205	1,285	1,325	1,350	1,210	1,275	1,325	1,400
-------	----	----	----	-----	---	----	-------	-------	-------	-------	-------	-------	-------	-------	-------

Cocoon chair passes CAL 133 certified for an upcharge of \$305 list per chair. Certification applies to Nienkämper leathers and fabrics that have a minimum of 50% natural fibre content. COM's and COL's are subject to approval. Add the extension -CAL to the model number when ordering.

Model # 10901  
Cocoon Lounge Chair



### Standard Features

- Seat cushion upholstered
- Frame: powder coat steel in silver, white, black or red
- Cover: available only in 30 mesh colors

# LOUNGE SEATING

Divvi Designer - Christopher Panichella

— US Only —

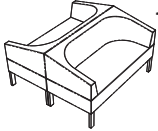
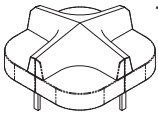
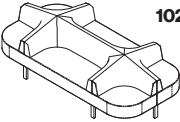
Model Number	Seat H"	Arm H"	W"	D"	H"	Fabric Yds	Leather Sq.Ft.	COM	COL	Verde	Grano	Cremoso	Knoll Textiles									
													1	2	3	4						
<b>DIVVI 2 SEATER</b>																						
	10241	17	25	52	26	31	5 3/8	102	4,135	4,340	6,520	7,120	7,700	4,670	5,170	5,695	6,240					
							3 3/8	66														
							2	36														
<b>DIVVI DOUBLE 2 SEATER</b>																						
	10242	17	25	52	52	31	11 1/8	204	8,240	8,660	12,995	14,190	15,375	9,315	10,305	11,355	12,445					
							7 1/8	132														
							4	72														
<b>DIVVI 4 SEATER</b>																						
	10243	17	25	52	52	31	8	144	10,360	10,870	13,725	14,565	15,405	11,115	11,820	12,565	13,335					
							4	72														
							4	72														
<b>DIVVI 8 SEATER</b>																						
	10244	17	25	106	52	31	15 1/8	276	18,575	19,495	25,015	26,625	28,240	20,020	21,360	22,785	24,275					
							8	144														
							7 1/8	132														

## Standard features:

- Brushed aluminum legs

Model # 10241



Model # 10242



Model # 10243



Model # 10244

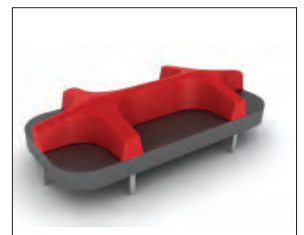

# LOUNGE SEATING

Dobi Designer – Nienkämper

— US Only —

Model Number	Seat H"	W"	D"	H"	Fabric Yds.	Leather Sq. Ft.	COM	COL	Verde	Grano	Cremoso	Knoll Textiles								
												1	2	3	4					
<b>11500</b>	16	30	30	31	3	54						2,350	2,465	3,815	4,315	4,510	2,625	2,895	3,175	3,465

**DOBI**

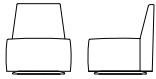

**Standard Features**

- 360 degree swivel base
- Foam has 20% soy content

**Model # 11500**  
**Dobi Chair**



# LOUNGE SEATING

Dune Metal Designer – busk + hertzog

— US Only —

Model Number	Seat H"	W"	D"	H"	Fabric Yds.	Leather Sq. Ft.	COM	COL	Neather	Verde	Grano	Cremoso	Knoll Textiles			
													1	2	3	4

## DUNE CHAIR



<b>10181</b>	15¾	33	31½	28½	4	54
--------------	-----	----	-----	-----	---	----

3,400	3,570	3,675	4,945	5,180	5,420	3,530	3,655	3,775	3,910
-------	-------	-------	-------	-------	-------	-------	-------	-------	-------

## DUNE 2 SEATER



<b>10182</b>	15¾	60½	31½	28½	6.5	117
--------------	-----	-----	-----	-----	-----	-----

5,605	5,890	6,195	8,860	9,370	9,890	5,895	6,150	6,420	6,700
-------	-------	-------	-------	-------	-------	-------	-------	-------	-------

## DUNE 3 SEATER

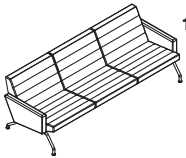

<b>10183</b>	15¾	88	31½	28½	10	180
--------------	-----	----	-----	-----	----	-----

7,805	8,200	8,705	12,760	13,555	14,350	8,245	8,645	9,055	9,495
-------	-------	-------	--------	--------	--------	-------	-------	-------	-------

**Model # 10181  
Dune Chair**



### Standard Features

- leg finish: mirror polish chrome, powder coat satin black

# LOUNGE SEATING

Dune Wood Designer – busk + hertzog

— US Only —

Model Number	Seat H"	W"	D"	H"	Fabric Yds.	Leather Sq. Ft.	COM	COL	Neather	Verde	Grano	Cremoso	Knoll Textiles			
													1	2	3	4

## DUNE CHAIR



<b>10184</b>	15¾	33	31½	28½	4	54	2,965	3,115	3,240	4,485	4,720	4,960	3,100	3,220	3,340	3,475
--------------	-----	----	-----	-----	---	----	-------	-------	-------	-------	-------	-------	-------	-------	-------	-------

## DUNE 2 SEATER

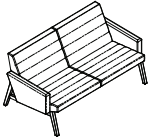

<b>10185</b>	15¾	60½	31½	28½	6.5	117	4,410	4,635	5,005	7,605	8,120	8,640	4,700	4,960	5,225	5,510
--------------	-----	-----	-----	-----	-----	-----	-------	-------	-------	-------	-------	-------	-------	-------	-------	-------

## DUNE 3 SEATER

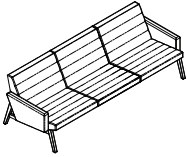

<b>10186</b>	15¾	88	31½	28½	10	180	5,900	6,195	6,800	10,760	11,550	12,345	6,340	6,740	7,140	7,585
--------------	-----	----	-----	-----	----	-----	-------	-------	-------	--------	--------	--------	-------	-------	-------	-------

**Model # 10184**  
Dune Chair



### Standard Features

- leg finish: Walnut and white oak.

# LOUNGE SEATING

Eden® Designer – Nienkämper

— US Only —

Model Number	Seat H"	Arm H"	* does not include arms			Fabric Yds.	Leather Sq. Ft.	COM	COL	Neather	Verde	Grano	Cremoso	Knoll Textiles			
			W"	D"	H"									1	2	3	4

## MEDIUM TWO SEAT WITH CLOSING ELEMENT

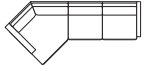

Left closing element

**1276\_** 17 24 ¼ 116 ¾ 56 ¼ 30 ¾

COM cushions & frame  
8 ¼ yds 10 yds

<b>(Model #6)</b> New York Arm, fully upholstered	17 ½	276	<b>16,670</b>	<b>17,500</b>	<b>18,620</b>	<b>25,605</b>	<b>27,965</b>	<b>28,910</b>	<b>18,320</b>	<b>19,840</b>	<b>21,475</b>	<b>23,170</b>
<b>(6)</b> New York Arm, COM cushions, leather frame	8 ¼	113		17,500		20,905	22,010	22,455				
<b>(Model #7)</b> Seattle Arm, fully upholstered	18	273	<b>16,925</b>	<b>17,770</b>	<b>18,950</b>	<b>25,955</b>	<b>28,310</b>	<b>29,265</b>	<b>18,620</b>	<b>20,195</b>	<b>21,875</b>	<b>23,610</b>
<b>(7)</b> Seattle Arm, COM cushions, leather frame	8 ¼	110		17,770		21,225	22,345	22,800				
<b>(Model #8)</b> Boston Arm, fully upholstered	18	279	<b>16,760</b>	<b>17,600</b>	<b>18,780</b>	<b>25,850</b>	<b>28,245</b>	<b>29,215</b>	<b>18,460</b>	<b>20,030</b>	<b>21,710</b>	<b>23,450</b>
<b>(8)</b> Boston Arm, COM cushions, leather frame	8 ¼	116		17,600		21,150	22,290	22,750				

## LARGE TWO SEAT WITH CLOSING ELEMENT

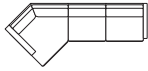

Left closing element

**1297\_** 17 24 ¼ 123 ¾ 56 ¼ 30 ¾

COM cushions & frame  
8 ¼ yds 10 ½ yds

<b>(Model #6)</b> New York Arm, fully upholstered	18	287	<b>17,105</b>	<b>17,955</b>	<b>19,105</b>	<b>26,560</b>	<b>29,060</b>	<b>30,045</b>	<b>18,805</b>	<b>20,370</b>	<b>22,050</b>	<b>23,790</b>
<b>(6)</b> New York Arm, COM cushions, leather frame	8 ¼	122		17,955		21,565	22,715	23,190				
<b>(Model #7)</b> Seattle Arm, fully upholstered	18 ½	285	<b>17,475</b>	<b>18,345</b>	<b>19,540</b>	<b>27,015</b>	<b>29,265</b>	<b>30,550</b>	<b>19,205</b>	<b>20,805</b>	<b>22,515</b>	<b>24,285</b>
<b>(7)</b> Seattle Arm, COM cushions, leather frame	8 ¼	120		18,345		22,010	23,190	23,660				
<b>(Model #8)</b> Boston Arm, fully upholstered	18 ½	290	<b>17,190</b>	<b>18,045</b>	<b>19,245</b>	<b>26,810</b>	<b>29,340</b>	<b>30,360</b>	<b>18,925</b>	<b>20,530</b>	<b>22,235</b>	<b>24,000</b>
<b>(8)</b> Boston Arm, COM cushions, leather frame	8 ¼	125		18,045		21,795	22,990	23,495				

Eden series passes CAL 133 certified for an upcharge of \$490 list per chair, \$975 list per two seater sofa, \$1460 list per three seater sofa, and \$485 list per ottoman. Certification applies to Nienkämper leathers and fabrics that have a minimum of 50% natural fibre content. COM's and COL's are subject to approval. Add the extension -CAL to the model number when ordering.

\*Add the width of the arm selected to the width of the sofa, see arm widths below right.

Back cushions have a foam core with Dacron wrap. Choose from two seat cushion fillings. Contract Filling is a firmer cushion. Residential Filling is a softer cushion. Both seat cushions are a combination of foam and down/feathers.

**Model #12958**  
Small two seat with closing element



**Model # 6**  
1 New York Arm  
3 ¾ W



**Model # 7**  
1 Seattle Arm  
4 ¾ W



**Model # 8**  
1 Boston Arm  
5 ½ W





# LOUNGE SEATING

Eden® Designer – Nienkämper

— US Only —

Model Number	Seat H"	Arm H"	* does not include arms			Fabric Yds.	Leather Sq. Ft.	COM	COL	Neather	Verde	Grano	Cremoso	Knoll Textiles			
			W"	D"	H"									1	2	3	4

## SMALL LOUNGE



**1277\_** 17 24 ¼ 23 ½ 33 30 ¾  
COM cushions & frame  
2 ¼ yds 4 yds



<b>(Model #1)</b> New York Arm, fully upholstered	6	87
<b>(1)</b> New York Arm, COM cushions, leather frame	2 ¼	57
<b>(Model #2)</b> Seattle Arm, fully upholstered	6	88
<b>(2)</b> Seattle Arm, COM cushions, leather frame	2 ¼	58
<b>(Model #3)</b> Phoenix Arm, fully upholstered	6	90
<b>(3)</b> Phoenix Arm, COM cushions, leather frame	2 ¼	60
<b>(Model #4)</b> Dallas Arm, fully upholstered	6	96
<b>(4)</b> Dallas Arm, COM cushions, leather frame	2 ¼	66
<b>(Model #5)</b> Miami Arm, fully upholstered	6	88
<b>(5)</b> Miami Arm, COM cushions, leather frame	2 ¼	58

<b>4,670</b>	<b>4,895</b>	<b>5,235</b>	<b>7,845</b>	<b>8,685</b>	<b>9,025</b>	<b>5,235</b>	<b>5,760</b>	<b>6,325</b>	<b>6,900</b>
	4,895		6,720	7,290	7,500				
<b>4,910</b>	<b>5,175</b>	<b>5,505</b>	<b>8,225</b>	<b>9,080</b>	<b>9,430</b>	<b>5,480</b>	<b>6,005</b>	<b>6,565</b>	<b>7,140</b>
	5,175		7,105	7,655	7,895				
<b>4,770</b>	<b>5,005</b>	<b>5,340</b>	<b>8,130</b>	<b>9,025</b>	<b>9,375</b>	<b>5,335</b>	<b>5,855</b>	<b>6,420</b>	<b>6,995</b>
	5,005		6,995	7,600	7,840				
<b>4,910</b>	<b>5,175</b>	<b>5,505</b>	<b>8,440</b>	<b>9,365</b>	<b>9,740</b>	<b>5,480</b>	<b>6,005</b>	<b>6,565</b>	<b>7,140</b>
	5,175		7,325	7,955	8,220				
<b>4,770</b>	<b>5,005</b>	<b>5,340</b>	<b>8,320</b>	<b>9,260</b>	<b>9,635</b>	<b>5,335</b>	<b>5,855</b>	<b>6,420</b>	<b>6,995</b>
	5,005		7,190	7,840	8,100				

## LARGE LOUNGE



**1270\_** 17 24 ¼ 27 ½ 33 30 ¾  
COM cushions & frame  
2 ¾ yds 4 yds



<b>(Model #1)</b> New York Arm, fully upholstered	6 ¼	96
<b>(1)</b> New York Arm, COM cushions, leather frame	2 ¾	61
<b>(Model #2)</b> Seattle Arm, fully upholstered	6 ¼	97
<b>(2)</b> Seattle Arm, COM cushions, leather frame	2 ¾	62
<b>(Model #3)</b> Phoenix Arm, fully upholstered	6 ¼	99
<b>(3)</b> Phoenix Arm, COM cushions, leather frame	2 ¾	64
<b>(Model #4)</b> Dallas Arm, fully upholstered	6 ½	105
<b>(4)</b> Dallas Arm, COM cushions, leather frame	2 ¾	70
<b>(Model #5)</b> Miami Arm, fully upholstered	6 ½	97
<b>(5)</b> Miami Arm, COM cushions, leather frame	2 ¾	62

<b>4,670</b>	<b>4,895</b>	<b>5,235</b>	<b>8,035</b>	<b>8,935</b>	<b>9,275</b>	<b>5,260</b>	<b>5,805</b>	<b>6,385</b>	<b>6,990</b>
	4,895		6,915	7,520	7,750				
<b>4,910</b>	<b>5,175</b>	<b>5,505</b>	<b>8,415</b>	<b>9,320</b>	<b>9,670</b>	<b>5,505</b>	<b>6,045</b>	<b>6,640</b>	<b>7,235</b>
	5,175		7,300	7,895	8,150				
<b>4,770</b>	<b>5,005</b>	<b>5,340</b>	<b>8,320</b>	<b>9,260</b>	<b>9,635</b>	<b>5,355</b>	<b>5,905</b>	<b>6,485</b>	<b>7,090</b>
	5,005		7,190	7,840	8,100				
<b>4,910</b>	<b>5,175</b>	<b>5,505</b>	<b>8,630</b>	<b>9,605</b>	<b>9,995</b>	<b>5,530</b>	<b>6,100</b>	<b>6,700</b>	<b>7,330</b>
	5,175		7,520	8,185	8,460				
<b>4,770</b>	<b>5,005</b>	<b>5,340</b>	<b>8,515</b>	<b>9,500</b>	<b>9,890</b>	<b>5,380</b>	<b>5,945</b>	<b>6,555</b>	<b>7,185</b>
	5,005		7,380	8,070	8,350				

Eden series passes CAL 133 certified for an upcharge of \$490 list per chair. Certification applies to Nienkämper leathers and fabrics that have a minimum of 50% natural fibre content. COM's and COL's are subject to approval. Add the extension -CAL to the model number when ordering.

\*Add the width of the arms selected to the width of the sofa, see arm widths below right.

Back cushions have a foam core with Dacron wrap. Choose from two seat cushion fillings. Contract Filling is a firmer cushion. Residential Filling is a softer cushion. Both seat cushions are a combination of foam and down/feathers.

Model # 1 2 New York Arms 6¾ W	Model # 2 2 Seattle Arms 9¾ W	Model # 3 2 Phoenix Arms 12¼ W	Model # 4 2 Dallas Arms 17¼ W	Model # 5 2 Miami Arms 17¼ W

# LOUNGE SEATING

Eden® Designer – Nienkämper

— US Only —

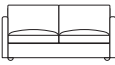
Model Number	Seat H"	Arm H"	* does not include arms			Fabric Yds.	Leather Sq. Ft.	COM	COL	Neather	Verde	Grano	Cremoso	Knoll Textiles			
			W"	D"	H"									1	2	3	4
<b>SMALL TWO SEAT SOFA</b>																	
	<b>1271_</b>	17	24¼	55	33	30¾											
	COM cushions & frame 5 ½ yds 6 yds																
<b>(Model #1)</b>	New York Arm, fully upholstered	10 ½	149	<b>7,110</b>	<b>7,440</b>	<b>8,105</b>	<b>12,440</b>	<b>13,870</b>	<b>14,425</b>	<b>8,105</b>	<b>9,015</b>	<b>10,000</b>	<b>11,010</b>				
<b>(1)</b>	New York Arm, COM cushions, leather frame	5 ½	80		7,440		10,285	11,115	11,455								
<b>(Model #2)</b>	Seattle Arm, fully upholstered	10 ½	150	<b>7,360</b>	<b>7,730</b>	<b>8,355</b>	<b>12,810</b>	<b>14,255</b>	<b>14,835</b>	<b>8,355</b>	<b>9,265</b>	<b>10,250</b>	<b>11,265</b>				
<b>(2)</b>	Seattle Arm, COM cushions, leather frame	5 ½	81		7,730		10,580	11,415	11,755								
<b>(Model #3)</b>	Phoenix Arm, fully upholstered	10 ½	152	<b>7,190</b>	<b>7,555</b>	<b>8,220</b>	<b>12,740</b>	<b>14,185</b>	<b>14,790</b>	<b>8,185</b>	<b>9,100</b>	<b>10,080</b>	<b>11,090</b>				
<b>(3)</b>	Phoenix Arm, COM cushions, leather frame	5 ½	83		7,555		10,490	11,360	11,705								
<b>(Model #4)</b>	Dallas Arm, fully upholstered	10 ½	158	<b>7,360</b>	<b>7,730</b>	<b>8,380</b>	<b>13,050</b>	<b>14,550</b>	<b>15,140</b>	<b>8,355</b>	<b>9,265</b>	<b>10,250</b>	<b>11,265</b>				
<b>(4)</b>	Dallas Arm, COM cushions, leather frame	5 ½	89		7,730		10,805	11,705	12,055								
<b>(Model #5)</b>	Miami Arm, fully upholstered	10 ½	150	<b>7,190</b>	<b>7,555</b>	<b>8,285</b>	<b>12,935</b>	<b>14,425</b>	<b>15,050</b>	<b>8,185</b>	<b>9,100</b>	<b>10,080</b>	<b>11,090</b>				
<b>(5)</b>	Miami Arm, COM cushions, leather frame	5 ½	81		7,555		10,680	11,595	11,970								





## MEDIUM TWO SEAT SOFA

	<b>1272_</b>	17	24¼	60½	33	30¾									
	COM cushions & frame 5 ½ yds 6 yds														
<b>(Model #1)</b>	New York Arm, fully upholstered	10 ½	159	<b>7,655</b>	<b>8,040</b>	<b>8,735</b>	<b>13,385</b>	<b>14,880</b>	<b>15,490</b>	<b>8,650</b>	<b>9,565</b>	<b>10,545</b>	<b>11,560</b>		
<b>(1)</b>	New York Arm, COM cushions, leather frame	5 ½	81		8,040		11,220	12,155	12,530						
<b>(Model #2)</b>	Seattle Arm, fully upholstered	10 ½	160	<b>7,930</b>	<b>8,320</b>	<b>8,945</b>	<b>13,770</b>	<b>15,295</b>	<b>15,920</b>	<b>8,925</b>	<b>9,840</b>	<b>10,830</b>	<b>11,835</b>		
<b>(2)</b>	Seattle Arm, COM cushions, leather frame	5 ½	82		8,320		11,515	12,470	12,845						
<b>(Model #3)</b>	Phoenix Arm, fully upholstered	10 ½	162	<b>7,770</b>	<b>8,150</b>	<b>8,780</b>	<b>13,695</b>	<b>15,250</b>	<b>15,870</b>	<b>8,765</b>	<b>9,680</b>	<b>10,660</b>	<b>11,670</b>		
<b>(3)</b>	Phoenix Arm, COM cushions, leather frame	5 ½	84		8,150		11,440	12,405	12,785						
<b>(Model #4)</b>	Dallas Arm, fully upholstered	10 ½	168	<b>7,930</b>	<b>8,320</b>	<b>8,960</b>	<b>13,985</b>	<b>15,585</b>	<b>16,220</b>	<b>8,925</b>	<b>9,840</b>	<b>10,830</b>	<b>11,835</b>		
<b>(4)</b>	Dallas Arm, COM cushions, leather frame	5 ½	90		8,320		11,750	12,755	13,155						
<b>(Model #5)</b>	Miami Arm, fully upholstered	10 ½	160	<b>7,760</b>	<b>8,135</b>	<b>8,860</b>	<b>13,870</b>	<b>15,465</b>	<b>16,115</b>	<b>8,760</b>	<b>9,675</b>	<b>10,655</b>	<b>11,665</b>		
<b>(5)</b>	Miami Arm, COM cushions, leather frame	5 ½	82		8,135		11,610	12,625	13,030						

Eden series passes CAL 133 certified for an upcharge of \$975 list per two seater sofa. Certification applies to Nienkämper leathers and fabrics that have a minimum of 50% natural fibre content. COM's and COL's are subject to approval. Add the extension -CAL to the model number when ordering.

\*Add the width of the arms selected to the width of the sofa, see arm widths below right.

Back cushions have a foam core with Dacron wrap. Choose from two seat cushion fillings. Contract Filling is a firmer cushion. Residential Filling is a softer cushion. Both seat cushions are a combination of foam and down/feathers.

Model # 1 2 New York Arms 6¾ W	Model # 2 2 Seattle Arms 9¾ W	Model # 3 2 Phoenix Arms 12¼ W	Model # 4 2 Dallas Arms 17¼ W	Model # 5 2 Miami Arms 17¼ W
				

# LOUNGE SEATING

Eden® Designer – Nienkämper

— US Only —

Model Number	Seat H"	Arm H"	*does not include arms			Fabric Yds.	Leather Sq. Ft.	COM	COL	Neather	Verde	Grano	Cremoso	Knoll Textiles			
			W"	D"	H"									1	2	3	4

## LARGE TWO SEAT SOFA

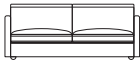

**1273\_** 17 24 ¼ 67 33 30 ¾

COM cushions & frame  
5 ½ yds 6 yds

<b>(Model #1)</b> New York Arm, fully upholstered	10 ½	170	<b>8,265</b>	<b>8,685</b>	<b>9,405</b>	<b>14,540</b>	<b>16,165</b>	<b>16,825</b>	<b>9,260</b>	<b>10,175</b>	<b>11,160</b>	<b>12,170</b>
<b>(1)</b> New York Arm, COM cushions, leather frame	5 ½	90		8,685		11,535	12,400	12,735				
<b>(Model #2)</b> Seattle Arm, fully upholstered	10 ½	171	<b>8,520</b>	<b>8,955</b>	<b>9,640</b>	<b>14,840</b>	<b>16,505</b>	<b>17,155</b>	<b>9,515</b>	<b>10,430</b>	<b>11,410</b>	<b>12,420</b>
<b>(2)</b> Seattle Arm, COM cushions, leather frame	5 ½	91		8,955		11,840	12,735	13,085				
<b>(Model #3)</b> Phoenix Arm, fully upholstered	10 ½	173	<b>8,375</b>	<b>8,790</b>	<b>9,505</b>	<b>14,825</b>	<b>16,515</b>	<b>17,190</b>	<b>9,370</b>	<b>10,285</b>	<b>11,270</b>	<b>12,275</b>
<b>(3)</b> Phoenix Arm, COM cushions, leather frame	5 ½	93		8,790		11,830	12,740	13,090				
<b>(Model #4)</b> Dallas Arm, fully upholstered	10 ½	177	<b>8,520</b>	<b>8,955</b>	<b>9,670</b>	<b>15,065</b>	<b>16,790</b>	<b>17,480</b>	<b>9,515</b>	<b>10,430</b>	<b>11,410</b>	<b>12,420</b>
<b>(4)</b> Dallas Arm, COM cushions, leather frame	5 ½	97		8,955		11,815	13,010	13,385				
<b>(Model #5)</b> Miami Arm, fully upholstered	10 ½	172	<b>8,375</b>	<b>8,790</b>	<b>9,540</b>	<b>15,005</b>	<b>16,750</b>	<b>17,445</b>	<b>9,370</b>	<b>10,285</b>	<b>11,270</b>	<b>12,275</b>
<b>(5)</b> Miami Arm, COM cushions, leather frame	5 ½	92		8,790		12,015	12,970	13,345				

## THREE SEAT SOFA

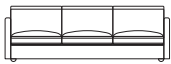

**1274\_** 17 24 ¼ 82 ½ 33 30 ¾

COM cushions & frame  
8 yds 8 yds

<b>(Model #1)</b> New York Arm, fully upholstered	15	203	<b>9,905</b>	<b>10,395</b>	<b>11,375</b>	<b>16,830</b>	<b>18,655</b>	<b>19,380</b>	<b>11,315</b>	<b>12,630</b>	<b>14,030</b>	<b>15,475</b>
<b>(1)</b> New York Arm, COM cushions, leather frame	8	100		10,395		13,465	14,400	14,785				
<b>(Model #2)</b> Seattle Arm, fully upholstered	15	203	<b>10,170</b>	<b>10,680</b>	<b>11,625</b>	<b>17,195</b>	<b>19,050</b>	<b>19,790</b>	<b>11,590</b>	<b>12,895</b>	<b>14,295</b>	<b>15,740</b>
<b>(2)</b> Seattle Arm, COM cushions, leather frame	8	100		10,680		13,820	14,795	15,185				
<b>(Model #3)</b> Phoenix Arm, fully upholstered	15	206	<b>10,000</b>	<b>10,515</b>	<b>11,470</b>	<b>17,115</b>	<b>18,990</b>	<b>19,735</b>	<b>11,415</b>	<b>12,730</b>	<b>14,125</b>	<b>15,575</b>
<b>(3)</b> Phoenix Arm, COM cushions, leather frame	8	103		10,515		13,745	14,745	15,105				
<b>(Model #4)</b> Dallas Arm, fully upholstered	15	209	<b>10,170</b>	<b>10,680</b>	<b>11,640</b>	<b>17,420</b>	<b>19,345</b>	<b>20,110</b>	<b>11,590</b>	<b>12,895</b>	<b>14,295</b>	<b>15,740</b>
<b>(4)</b> Dallas Arm, COM cushions, leather frame	8	108		10,680		14,055	15,070	15,490				
<b>(Model #5)</b> Miami Arm, fully upholstered	15	204	<b>10,000</b>	<b>10,515</b>	<b>11,495</b>	<b>17,305</b>	<b>19,230</b>	<b>19,995</b>	<b>11,415</b>	<b>12,730</b>	<b>14,125</b>	<b>15,575</b>
<b>(5)</b> Miami Arm, COM cushions, leather frame	8	101		10,515		13,940	14,980	15,380				

Eden series passes CAL 133 certified for an upcharge of \$1460 list per three seat sofa. Certification applies to Nienkämper leathers and fabrics that have a minimum of 50% natural fibre content. COM's and COL's are subject to approval. Add the extension -CAL to the model number when ordering.

\*Add the width of the arms selected to the width of the sofa, see arm widths below right.

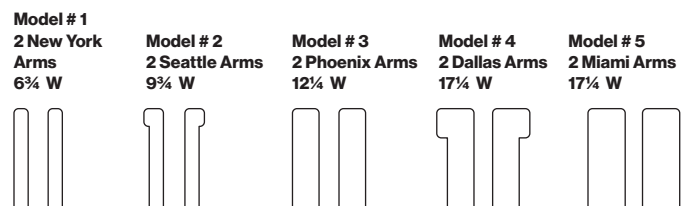

Back cushions have a foam core with Dacron wrap. Choose from two seat cushion fillings. Contract Filling is a firmer cushion. Residential Filling is a softer cushion. Both seat cushions are a combination of foam and down/feathers.



# LOUNGE SEATING

Eden® Designer – Nienkämper

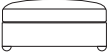
— US Only —

Model Number	W"	D"	H"	Fabric Yds.	Leather Sq.Ft.	COM	COL	Neather	Verde	Grano	Cremoso	Knoll Textiles			
												1	2	3	4
<b>SMALL OTTOMAN</b>															
 <b>1275</b>	27½	19¾	17	2½	45	1,870	1,980	2,140	3,380	3,775	3,930	2,120	2,335	2,565	2,805
<b>LARGE OTTOMAN</b>															
 <b>1276</b>	34¾	34¾	17	3½	54	2,310	2,430	2,640	4,105	4,585	4,785	2,645	2,950	3,280	3,615
<b>SMALL THROW CUSHION</b>															
 <b>127S</b>	16	16		½	8	285	295	330	570	640	685	335	375	430	475
<b>LARGE THROW CUSHION</b>															
 <b>127L</b>	20	20		¾	10	285	295	355	640	745	790	360	420	495	570

**Eden series passes CAL 133 certified for an upcharge of \$485 list per ottoman. Certification applies to Nienkämper leathers and fabrics that have a minimum of 50% natural fibre content. COM's and COL's are subject to approval. Add the extension -CAL to the model number when ordering.**

Seat cushions are a combination of foam and down/feathers.

# LOUNGE SEATING

Eden® Designer – Nienkämper

— US Only —

Model Number	Seat H"	Arm H"	* does not include arms			Fabric Yds.	Leather Sq. Ft.	COM	COL	Neather	Verde	Grano	Cremoso	Knoll Textiles			
			W"	D"	H"									1	2	3	4

## SMALL TWO SEAT SOFA, DEEP

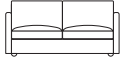

**1280\_** 17 24 1/4 55 38 1/2 30 3/4

COM cushions & frame  
5 2/3 yds 6 1/2 yds

<b>(Model #1)</b> New York Arm, fully upholstered	12	152	<b>8,200</b>	<b>8,595</b>	<b>9,320</b>	<b>14,110</b>	<b>15,670</b>	<b>16,295</b>	<b>9,330</b>	<b>10,375</b>	<b>11,495</b>	<b>12,650</b>
<b>(1)</b> New York Arm, COM cushions, leather frame	5 3/4	82		8,595		11,110	11,880	12,200				
<b>(Model #2)</b> Seattle Arm, fully upholstered	12	156	<b>8,440</b>	<b>8,865</b>	<b>9,555</b>	<b>14,425</b>	<b>16,010</b>	<b>16,630</b>	<b>9,575</b>	<b>10,625</b>	<b>11,735</b>	<b>12,895</b>
<b>(2)</b> Seattle Arm, COM cushions, leather frame	5 3/4	86		8,865		11,440	12,220	12,540				
<b>(Model #3)</b> Phoenix Arm, fully upholstered	12	157	<b>8,285</b>	<b>8,705</b>	<b>9,415</b>	<b>14,380</b>	<b>15,990</b>	<b>16,640</b>	<b>9,420</b>	<b>10,465</b>	<b>11,590</b>	<b>12,745</b>
<b>(3)</b> Phoenix Arm, COM cushions, leather frame	5 3/4	87		8,705		11,400	12,210	12,550				
<b>(Model #4)</b> Dallas Arm, fully upholstered	12	163	<b>8,440</b>	<b>8,865</b>	<b>9,595</b>	<b>14,645</b>	<b>16,295</b>	<b>16,940</b>	<b>9,575</b>	<b>10,625</b>	<b>11,735</b>	<b>12,895</b>
<b>(4)</b> Dallas Arm, COM cushions, leather frame	5 3/4	93		8,865		11,640	12,515	12,845				
<b>(Model #5)</b> Miami Arm, fully upholstered	12	162	<b>8,285</b>	<b>8,705</b>	<b>9,440</b>	<b>14,575</b>	<b>16,230</b>	<b>16,905</b>	<b>9,420</b>	<b>10,465</b>	<b>11,590</b>	<b>12,745</b>
<b>(5)</b> Miami Arm, COM cushions, leather frame	5 3/4	92		8,705		11,590	12,440	12,790				

## LARGE TWO SEAT SOFA, DEEP

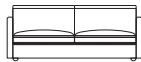

**1281\_** 17 24 1/4 67 38 1/2 30 3/4

COM cushions & frame  
5 3/4 yds 6 1/2 yds

<b>(Model #1)</b> New York Arm, fully upholstered	12	173	<b>9,475</b>	<b>9,950</b>	<b>10,935</b>	<b>16,400</b>	<b>18,230</b>	<b>18,955</b>	<b>10,615</b>	<b>11,650</b>	<b>12,770</b>	<b>13,930</b>
<b>(1)</b> New York Arm, COM cushions, leather frame	15 3/4	90		9,950		13,030	13,960	14,350				
<b>(Model #2)</b> Seattle Arm, fully upholstered	12	177	<b>9,730</b>	<b>10,215</b>	<b>11,185</b>	<b>16,760</b>	<b>18,615</b>	<b>19,360</b>	<b>10,865</b>	<b>11,905</b>	<b>13,030</b>	<b>14,185</b>
<b>(2)</b> Seattle Arm, COM cushions, leather frame	15 3/4	94		10,215		13,395	14,360	14,750				
<b>(Model #3)</b> Phoenix Arm, fully upholstered	12	178	<b>9,590</b>	<b>10,070</b>	<b>11,040</b>	<b>16,690</b>	<b>18,575</b>	<b>19,330</b>	<b>10,730</b>	<b>11,775</b>	<b>12,890</b>	<b>14,050</b>
<b>(3)</b> Phoenix Arm, COM cushions, leather frame	15 3/4	95		10,070		13,325	14,320	14,695				
<b>(Model #4)</b> Dallas Arm, fully upholstered	12	184	<b>9,730</b>	<b>10,215</b>	<b>11,220</b>	<b>17,000</b>	<b>18,910</b>	<b>19,665</b>	<b>10,865</b>	<b>11,905</b>	<b>13,030</b>	<b>14,185</b>
<b>(4)</b> Dallas Arm, COM cushions, leather frame	5 3/4	101		10,215		13,620	14,640	15,060				
<b>(Model #5)</b> Miami Arm, fully upholstered	12	183	<b>9,590</b>	<b>10,070</b>	<b>11,075</b>	<b>16,880</b>	<b>18,810</b>	<b>19,570</b>	<b>10,730</b>	<b>11,775</b>	<b>12,890</b>	<b>14,050</b>
<b>(5)</b> Miami Arm, COM cushions, leather frame	5 3/4	100		10,070		13,515	14,550	14,975				

Eden series passes CAL 133 certified for an upcharge of \$975 list per two seater sofa. Certification applies to Nienkämper leathers and fabrics that have a minimum of 50% natural fibre content. COM's and COL's are subject to approval. Add the extension -CAL to the model number when ordering.

\*Add the width of the arms selected to the width of the sofa, see arm widths below right.

Back cushions have a foam core with Dacron wrap. Choose from two seat cushion fillings. Contract Filling is a firmer cushion. Residential Filling is a softer cushion. Both seat cushions are a combination of foam and down/feathers.

**Model #12813**  
Large two seat, deep



**Model # 1**  
2 New York Arms  
6 3/4 W



**Model # 2**  
2 Seattle Arms  
9 3/4 W



**Model # 3**  
2 Phoenix Arms  
12 1/4 W

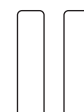

**Model # 4**  
2 Dallas Arms  
17 1/4 W

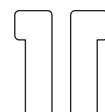

**Model # 5**  
2 Miami Arms  
17 1/4 W

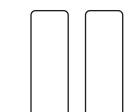

# LOUNGE SEATING

Eden® Designer – Nienkämper

— US Only —

Model Number	Seat H"	Arm H"	* does not include arms			Fabric Yds.	Leather Sq. Ft.	COM	COL	Neather	Verde	Grano	Cremoso	Knoll Textiles				
			W"	D"	H"									1	2	3	4	
<b>THREE SEAT SOFA, DEEP</b>																		
																		
1282_	17	24 <sup>1</sup> / <sub>4</sub>	82 <sup>1</sup> / <sub>2</sub>	38 <sup>1</sup> / <sub>2</sub>	30 <sup>3</sup> / <sub>4</sub>													
COM cushions & frame 5 <sup>2</sup> / <sub>3</sub> yds 6 <sup>1</sup> / <sub>2</sub> yds																		
<b>(Model #1)</b>	New York Arm, fully upholstered					<b>12</b>	<b>205</b>	<b>10,880</b>	<b>11,415</b>	<b>12,435</b>	<b>18,435</b>	<b>20,420</b>	<b>21,220</b>	<b>12,015</b>	<b>13,060</b>	<b>14,175</b>	<b>15,340</b>	
<b>(1)</b>	New York Arm, COM cushions, leather frame					5 <sup>1</sup> / <sub>2</sub>	100		11,415		14,680	15,700	16,110					
<b>(Model #2)</b>	Seattle Arm, fully upholstered					<b>12</b>	<b>210</b>	<b>11,130</b>	<b>11,690</b>	<b>12,745</b>	<b>18,775</b>	<b>20,775</b>	<b>21,595</b>	<b>12,270</b>	<b>13,315</b>	<b>14,435</b>	<b>15,595</b>	
<b>(2)</b>	Seattle Arm, COM cushions, leather frame					5 <sup>2</sup> / <sub>3</sub>	105		11,690		15,035	16,050	16,465					
<b>(Model #3)</b>	Phoenix Arm, fully upholstered					<b>12</b>	<b>211</b>	<b>10,990</b>	<b>11,535</b>	<b>12,590</b>	<b>18,730</b>	<b>20,770</b>	<b>21,580</b>	<b>12,125</b>	<b>13,170</b>	<b>14,290</b>	<b>15,450</b>	
<b>(3)</b>	Phoenix Arm, COM cushions, leather frame					5 <sup>2</sup> / <sub>3</sub>	106		11,535		14,990	16,045	16,455					
<b>(Model #4)</b>	Dallas Arm, fully upholstered					<b>12</b>	<b>216</b>	<b>11,130</b>	<b>11,690</b>	<b>12,745</b>	<b>18,995</b>	<b>21,075</b>	<b>21,885</b>	<b>12,270</b>	<b>13,315</b>	<b>14,435</b>	<b>15,595</b>	
<b>(4)</b>	Dallas Arm, COM cushions, leather frame					5 <sup>2</sup> / <sub>3</sub>	110		11,690		15,260	16,340	16,780					
<b>(Model #5)</b>	Miami Arm, fully upholstered					<b>12</b>	<b>215</b>	<b>10,990</b>	<b>11,535</b>	<b>12,590</b>	<b>18,925</b>	<b>21,000</b>	<b>21,830</b>	<b>12,125</b>	<b>13,170</b>	<b>14,290</b>	<b>15,450</b>	
<b>(5)</b>	Miami Arm, COM cushions, leather frame					5 <sup>2</sup> / <sub>3</sub>	110		11,535		15,185	16,290	16,720					

Eden series passes CAL 133 certified for an upcharge of \$1460 list per three seat sofa. Certification applies to Nienkämper leathers and fabrics that have a minimum of 50% natural fibre content. COM's and COL's are subject to approval. Add the extension -CAL to the model number when ordering.

\*Add the width of the arms selected to the width of the sofa, see arm widths below right.

Back cushions have a foam core with Dacron wrap. Choose from two seat cushion fillings. Contract Filling is a firmer cushion. Residential Filling is a softer cushion. Both seat cushions are a combination of foam and down/feathers.

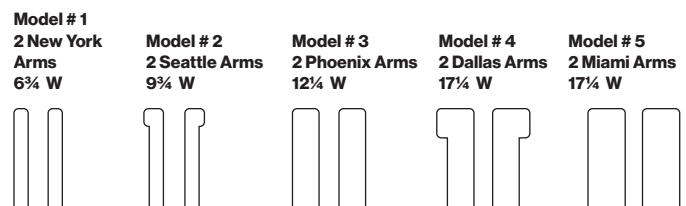

# LOUNGE SEATING

Eden® Designer – Nienkämper

— US Only —

Model Number	Seat H"	Arm H"	* does not include arms			Fabric Yds.	Leather Sq.Ft.	COM	COL	Neather	Verde	Grano	Cremoso	Knoll Textiles			
			W"	D"	H"									1	2	3	4
<b>FOUR SEAT 90° CORNER</b>																	
 <b>1283_</b>	17	24 ¼	88	60 ½	30 ¾												
COM cushions & frame 12 ⅔ yds 9 yds																	
<b>(Model #1)</b> New York Arm, fully upholstered						20 ⅔	289	<b>15,830</b>	<b>16,630</b>	<b>17,865</b>	<b>25,230</b>	<b>27,700</b>	<b>28,695</b>	<b>17,780</b>	<b>19,590</b>	<b>21,510</b>	<b>23,510</b>
<b>(1)</b> New York Arm, COM cushions, leather frame						12 ⅔	136		16,630		20,370	21,570	22,030				
<b>(Model #2)</b> Seattle Arm, fully upholstered						20 ⅔	289	<b>16,115</b>	<b>16,915</b>	<b>18,150</b>	<b>25,605</b>	<b>28,110</b>	<b>29,105</b>	<b>18,055</b>	<b>19,870</b>	<b>21,790</b>	<b>23,785</b>
<b>(2)</b> Seattle Arm, COM cushions, leather frame						12 ⅔	136		16,915		20,755	21,980	22,455				
<b>(Model #3)</b> Phoenix Arm, fully upholstered						20 ⅔	291	<b>15,930</b>	<b>16,730</b>	<b>17,970</b>	<b>25,505</b>	<b>28,035</b>	<b>29,050</b>	<b>17,880</b>	<b>19,685</b>	<b>21,605</b>	<b>23,605</b>
<b>(3)</b> Phoenix Arm, COM cushions, leather frame						12 ⅔	138		16,730		20,655	21,885	22,385				
<b>(Model #4)</b> Dallas Arm, fully upholstered						21 ¼	298	<b>16,115</b>	<b>16,915</b>	<b>18,210</b>	<b>25,840</b>	<b>28,405</b>	<b>29,430</b>	<b>18,115</b>	<b>19,975</b>	<b>21,955</b>	<b>24,000</b>
<b>(4)</b> Dallas Arm, COM cushions, leather frame						12 ⅔	145		16,915		20,965	22,245	22,755				
<b>(Model #5)</b> Miami Arm, fully upholstered						21 ¼	284	<b>15,930</b>	<b>16,730</b>	<b>18,030</b>	<b>25,705</b>	<b>28,265</b>	<b>29,295</b>	<b>17,930</b>	<b>19,790</b>	<b>21,770</b>	<b>23,815</b>
<b>(5)</b> Miami Arm, COM cushions, leather frame						12 ⅔	131		16,730		20,840	22,120	22,655				

## FIVE SEAT 90° CORNER

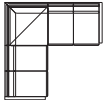
 <b>1284_</b>	17	24 ¼	88	88	30 ¾												
COM cushions & frame 15 ⅓ yds 10 ⅓ yds																	
<b>(Model #1)</b> New York Arm, fully upholstered						24 ⅔	342	<b>18,320</b>	<b>19,240</b>	<b>20,210</b>	<b>29,390</b>	<b>32,305</b>	<b>33,465</b>	<b>20,650</b>	<b>22,805</b>	<b>25,095</b>	<b>27,480</b>
<b>(1)</b> New York Arm, COM cushions, leather frame						15 ⅓	154		19,240		23,520	24,885	25,445				
<b>(Model #2)</b> Seattle Arm, fully upholstered						24 ⅔	342	<b>18,580</b>	<b>19,510</b>	<b>21,000</b>	<b>29,760</b>	<b>32,705</b>	<b>33,895</b>	<b>20,910</b>	<b>23,065</b>	<b>25,355</b>	<b>27,740</b>
<b>(2)</b> Seattle Arm, COM cushions, leather frame						15 ⅓	154		19,510		23,890	25,290	25,845				
<b>(Model #3)</b> Phoenix Arm, fully upholstered						24 ⅔	344	<b>18,435</b>	<b>19,360</b>	<b>20,855</b>	<b>29,695</b>	<b>32,665</b>	<b>33,840</b>	<b>20,760</b>	<b>22,920</b>	<b>25,215</b>	<b>27,590</b>
<b>(3)</b> Phoenix Arm, COM cushions, leather frame						15 ⅓	156		19,360		23,815	25,230	25,810				
<b>(Model #4)</b> Dallas Arm, fully upholstered						25 ¼	351	<b>18,580</b>	<b>19,510</b>	<b>20,530</b>	<b>29,985</b>	<b>33,000</b>	<b>34,200</b>	<b>20,965</b>	<b>23,170</b>	<b>25,525</b>	<b>27,960</b>
<b>(4)</b> Dallas Arm, COM cushions, leather frame						15 ⅓	163		19,510		24,115	25,570	26,170				
<b>(Model #5)</b> Miami Arm, fully upholstered						25 ¼	343	<b>18,435</b>	<b>19,360</b>	<b>20,925</b>	<b>29,890</b>	<b>32,895</b>	<b>34,095</b>	<b>20,815</b>	<b>23,020</b>	<b>25,380</b>	<b>27,810</b>
<b>(5)</b> Miami Arm, COM cushions, leather frame						15 ¼	155		19,360		24,000	25,465	26,060				

Eden series passes CAL 133 certified for an upcharge of \$2140 list per four seat sofa. Certification applies to Nienkämper leathers and fabrics that have a minimum of 50% natural fibre content. COM's and COL's are subject to approval. Add the extension -CAL to the model number when ordering.

\*Add the width of the arms selected to the width of the sofa, see arm widths below right.

Back cushions have a foam core with Dacron wrap. Choose from two seat cushion fillings. Contract Filling is a firmer cushion. Residential Filling is a softer cushion. Both seat cushions are a combination of foam and down/feathers.

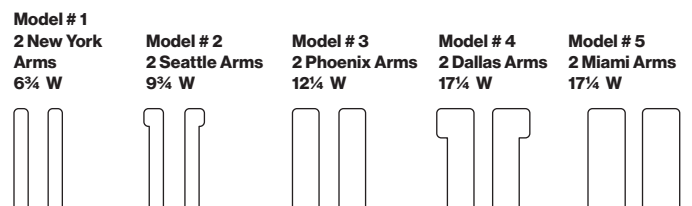

# LOUNGE SEATING

Eden® Designer – Nienkämper

— US Only —

Model Number	Seat		Arm			Fabric Yds.	Leather Sq. Ft.	COM	COL	Neather	Verde	Grano	Cremoso	Knoll Textiles			
	H"	H"	W"	D"	H"									1	2	3	4

\* does not include arms

## SIX SEAT 90° CORNER

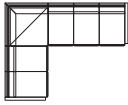

**1285\_** 17 24 ¼ 115 ½ 88 30 ¾

COM cushions & frame  
18yds 11 ½ yds

<b>(Model #1)</b> New York Arm, fully upholstered	28%	407	<b>21,090</b>	<b>22,125</b>	<b>23,920</b>	<b>33,845</b>	<b>37,210</b>	<b>38,545</b>	<b>23,790</b>	<b>26,300</b>	<b>28,970</b>	<b>31,735</b>
<b>(1)</b> New York Arm, COM cushions, leather frame	18	174		22,125		26,970		28,510		29,110		
<b>(Model #2)</b> Seattle Arm, fully upholstered	28%	407	<b>21,345</b>	<b>22,425</b>	<b>24,165</b>	<b>34,215</b>	<b>37,610</b>	<b>38,970</b>	<b>24,055</b>	<b>26,555</b>	<b>29,230</b>	<b>31,990</b>
<b>(2)</b> Seattle Arm, COM cushions, leather frame	18	174		22,425		27,335		29,050		29,540		
<b>(Model #3)</b> Phoenix Arm, fully upholstered	28%	409	<b>21,190</b>	<b>22,245</b>	<b>24,015</b>	<b>34,155</b>	<b>37,555</b>	<b>38,920</b>	<b>23,895</b>	<b>26,405</b>	<b>29,070</b>	<b>31,840</b>
<b>(3)</b> Phoenix Arm, COM cushions, leather frame	18	176		22,245		27,255		28,855		29,485		
<b>(Model #4)</b> Dallas Arm, fully upholstered	29 ¼	416	<b>21,345</b>	<b>22,425</b>	<b>24,220</b>	<b>34,435</b>	<b>37,890</b>	<b>39,265</b>	<b>24,105</b>	<b>26,655</b>	<b>29,385</b>	<b>32,210</b>
<b>(4)</b> Dallas Arm, COM cushions, leather frame	18	183		22,425		27,555		29,190		29,835		
<b>(Model #5)</b> Miami Arm, fully upholstered	29 ¼	408	<b>21,190</b>	<b>22,245</b>	<b>24,075</b>	<b>34,335</b>	<b>37,795</b>	<b>39,175</b>	<b>23,955</b>	<b>26,510</b>	<b>29,235</b>	<b>32,055</b>
<b>(5)</b> Miami Arm, COM cushions, leather frame	18	175		22,245		27,435		29,095		29,745		

## SEVEN SEAT 90° CORNER

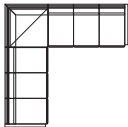

**1286\_** 17 24 ¼ 115 ½ 115 ½ 30 ¾

COM cushions & frame  
20 ¾ yds 13 yds

<b>(Model #1)</b> New York Arm, fully upholstered	32%	450	<b>23,815</b>	<b>25,010</b>	<b>27,035</b>	<b>38,270</b>	<b>42,070</b>	<b>43,595</b>	<b>26,905</b>	<b>29,760</b>	<b>32,800</b>	<b>35,945</b>
<b>(1)</b> New York Arm, COM cushions, leather frame	20%	192		25,010		30,370		32,085		32,785		
<b>(Model #2)</b> Seattle Arm, fully upholstered	32%	450	<b>24,075</b>	<b>25,280</b>	<b>27,290</b>	<b>38,625</b>	<b>42,465</b>	<b>44,005</b>	<b>27,155</b>	<b>30,010</b>	<b>33,045</b>	<b>36,200</b>
<b>(2)</b> Seattle Arm, COM cushions, leather frame	20%	192		25,280		30,725		32,480		33,200		
<b>(Model #3)</b> Phoenix Arm, fully upholstered	32%	452	<b>23,920</b>	<b>25,105</b>	<b>27,150</b>	<b>38,550</b>	<b>42,420</b>	<b>43,950</b>	<b>27,005</b>	<b>29,860</b>	<b>32,900</b>	<b>36,050</b>
<b>(3)</b> Phoenix Arm, COM cushions, leather frame	20%	194		25,105		30,660		32,435		33,140		
<b>(Model #4)</b> Dallas Arm, fully upholstered	33 ¼	459	<b>24,075</b>	<b>25,280</b>	<b>27,360</b>	<b>38,845</b>	<b>42,730</b>	<b>44,300</b>	<b>27,205</b>	<b>30,115</b>	<b>33,215</b>	<b>36,420</b>
<b>(4)</b> Dallas Arm, COM cushions, leather frame	20%	201		25,280		30,905		32,780		33,490		
<b>(Model #5)</b> Miami Arm, fully upholstered	33 ¼	452	<b>23,920</b>	<b>25,105</b>	<b>27,195</b>	<b>38,740</b>	<b>42,650</b>	<b>44,200</b>	<b>27,055</b>	<b>29,965</b>	<b>33,060</b>	<b>36,270</b>
<b>(5)</b> Miami Arm, COM cushions, leather frame	20%	194		25,105		30,850		32,675		33,405		

Eden series passes CAL 133 certified for an upcharge of \$2915 list for six seat and \$3400 list for seven seat. Certification applies to Nienkämper leathers and fabrics that have a minimum of 50% natural fibre content. COM's and COL's are subject to approval. Add the extension -CAL to the model number when ordering.

\*Add the width of the arms selected to the width of the sofa, see arm widths below right.

Back cushions have a foam core with Dacron wrap. Choose from two seat cushion fillings. Contract Filling is a firmer cushion. Residential Filling is a softer cushion. Both seat cushions are a combination of foam and down/feathers.

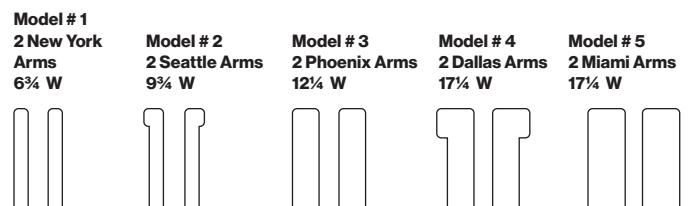



# LOUNGE SEATING

Eden® Designer – Nienkämper

— US Only —

Model Number	Seat H"	Arm H"	W"	*does not include arms			Fabric Yds.	Leather Sq.Ft.	COM	COL	Neather	Verde	Grano	Cremoso	Knoll Textiles			
				D"	H"										1	2	3	4

## FIVE SEAT QUADRILATERAL CORNER

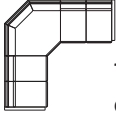

**1287\_** 17 24¼ 102 130 30¾

COM cushions & frame  
15yds 13yds

<b>(Model #1)</b> New York Arm, fully upholstered	27¼	372	<b>21,105</b>	<b>22,165</b>	<b>23,785</b>	<b>33,570</b>	<b>36,850</b>	<b>38,160</b>	<b>23,680</b>	<b>26,060</b>	<b>28,600</b>	<b>31,230</b>
<b>(1)</b> New York Arm, COM cushions, leather frame	15	163		22,165		26,865	28,395	29,015				
<b>(Model #2)</b> Seattle Arm, fully upholstered	27¾	372	<b>21,375</b>	<b>22,440</b>	<b>24,105</b>	<b>33,960</b>	<b>37,255</b>	<b>38,560</b>	<b>23,990</b>	<b>26,410</b>	<b>28,980</b>	<b>31,655</b>
<b>(2)</b> Seattle Arm, COM cushions, leather frame	15	163		22,440		27,235	28,810	29,415				
<b>(Model #3)</b> Phoenix Arm, fully upholstered	27¾	375	<b>21,220</b>	<b>22,275</b>	<b>23,950</b>	<b>33,865</b>	<b>37,190</b>	<b>38,525</b>	<b>23,825</b>	<b>26,240</b>	<b>28,820</b>	<b>31,485</b>
<b>(3)</b> Phoenix Arm, COM cushions, leather frame	15	166		22,275		27,170	28,730	29,355				
<b>(Model #4)</b> Dallas Arm, fully upholstered	27¾	386	<b>21,375</b>	<b>22,440</b>	<b>24,105</b>	<b>34,175</b>	<b>37,550</b>	<b>38,885</b>	<b>23,990</b>	<b>26,410</b>	<b>28,980</b>	<b>31,655</b>
<b>(4)</b> Dallas Arm, COM cushions, leather frame	15	173		22,440		27,475	29,070	29,730				
<b>(Model #5)</b> Miami Arm, fully upholstered	27¾	365	<b>21,220</b>	<b>22,275</b>	<b>23,950</b>	<b>34,050</b>	<b>37,420</b>	<b>38,790</b>	<b>23,825</b>	<b>26,240</b>	<b>28,820</b>	<b>31,485</b>
<b>(5)</b> Miami Arm, COM cushions, leather frame	15	164		22,275		27,355	28,960	29,620				

Eden series passes CAL 133 certified for an upcharge of \$2915 list for six seat, \$3400 list for seven seat, and \$3700 list for eight seat. Certification applies to Nienkämper leathers and fabrics that have a minimum of 50% natural fibre content. COM's and COL's are subject to approval. Add the extension -CAL to the model number when ordering.

\*Add the width of the arms selected to the width of the sofa, see arm widths below right.

Back cushions have a foam core with Dacron wrap. Choose from two seat cushion fillings. Contract Filling is a firmer cushion. Residential Filling is a softer cushion. Both seat cushions are a combination of foam and down/feathers.

<b>Model # 1</b> 2 New York Arms 6¾ W	<b>Model # 2</b> 2 Seattle Arms 9¾ W	<b>Model # 3</b> 2 Phoenix Arms 12¾ W	<b>Model # 4</b> 2 Dallas Arms 17¾ W	<b>Model # 5</b> 2 Miami Arms 17¾ W

# LOUNGE SEATING

Eden® Designer – Nienkämper

— US Only —

Model Number	Seat Arm		* does not include arms			Fabric Yds.	Leather Sq. Ft.	COM	COL	Neather	Verde	Grano	Cremoso	Knoll Textiles			
	H"	H"	W"	D"	H"									1	2	3	4

## SIX SEAT QUADRILATERAL CORNER

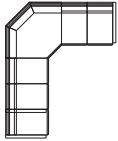

**1288\_** 17 24¼ 102½ 130 30¾

COM cushions & frame  
17½ yds 14 ½ yds

<b>(Model #1)</b> New York Arm, fully upholstered	31¼	427	<b>23,865</b>	<b>25,065</b>	<b>26,950</b>	<b>38,010</b>	<b>41,725</b>	<b>43,220</b>	<b>26,810</b>	<b>29,540</b>	<b>32,455</b>	<b>35,465</b>
<b>(1)</b> New York Arm, COM cushions, leather frame	17½	183		25,065		30,300	32,005	32,680				
<b>(Model #2)</b> Seattle Arm, fully upholstered	31¾	427	<b>24,115</b>	<b>25,305</b>	<b>27,225</b>	<b>38,355</b>	<b>42,115</b>	<b>43,620</b>	<b>27,105</b>	<b>29,870</b>	<b>32,820</b>	<b>35,875</b>
<b>(2)</b> Seattle Arm, COM cushions, leather frame	17½	183		25,305		30,660	32,395	33,060				
<b>(Model #3)</b> Phoenix Arm, fully upholstered	31¾	429	<b>23,955</b>	<b>25,135</b>	<b>27,060</b>	<b>38,295</b>	<b>42,060</b>	<b>43,575</b>	<b>26,940</b>	<b>29,705</b>	<b>32,655</b>	<b>35,710</b>
<b>(3)</b> Phoenix Arm, COM cushions, leather frame	17½	185		25,135		30,580	32,320	33,010				
<b>(Model #4)</b> Dallas Arm, fully upholstered	31¾	435	<b>24,115</b>	<b>25,305</b>	<b>27,225</b>	<b>38,590</b>	<b>42,420</b>	<b>43,935</b>	<b>27,105</b>	<b>29,870</b>	<b>32,820</b>	<b>35,875</b>
<b>(4)</b> Dallas Arm, COM cushions, leather frame	17½	192		25,305		30,885	32,675	33,385				
<b>(Model #5)</b> Miami Arm, fully upholstered	31¾	428	<b>23,955</b>	<b>25,135</b>	<b>27,060</b>	<b>38,480</b>	<b>42,295</b>	<b>43,825</b>	<b>26,940</b>	<b>29,705</b>	<b>32,655</b>	<b>35,710</b>
<b>(5)</b> Miami Arm, COM cushions, leather frame	17½	184		25,135		30,775	32,575	33,265				

Eden series passes CAL 133 certified for an upcharge of \$2915 list for six seat. Certification applies to Nienkämper leathers and fabrics that have a minimum of 50% natural fibre content. COM's and COL's are subject to approval. Add the extension -CAL to the model number when ordering.

\*Add the width of the arms selected to the width of the sofa, see arm widths below right.

Back cushions have a foam core with Dacron wrap. Choose from two seat cushion fillings. Contract Filling is a firmer cushion. Residential Filling is a softer cushion. Both seat cushions are a combination of foam and down/feathers.

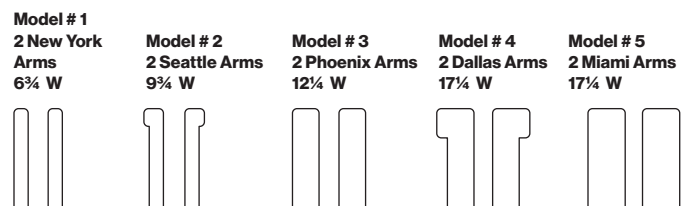

# LOUNGE SEATING

Eden® Designer – Nienkämper

— US Only —

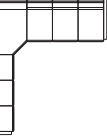
Model Number	Seat Arm		* does not include arms			Fabric Yds.	Leather Sq.Ft.	COM	COL	Neather	Verde	Grano	Cremoso	Knoll Textiles				
	H"	H"	W"	D"	H"									1	2	3	4	
<b>SEVEN SEAT QUADRILATERAL CORNER</b>																		
	1289_	17	24 ¼	130	130	30 ¾												
	COM cushions & frame 20 ¼ yds 15 ¾ yds																	
<b>(Model #1)</b>	New York Arm, fully upholstered						35 ¼	481	<b>26,600</b>	<b>27,940</b>	<b>30,070</b>	<b>42,435</b>	<b>46,590</b>	<b>48,255</b>	<b>29,925</b>	<b>33,005</b>	<b>36,290</b>	<b>39,685</b>
<b>(1)</b>	New York Arm, COM cushions, leather frame						20 ¼	201		27,940		33,705	35,570	36,315				
<b>(Model #2)</b>	Seattle Arm, fully upholstered						35 ¾	480	<b>26,860</b>	<b>28,200</b>	<b>30,380</b>	<b>42,800</b>	<b>47,000</b>	<b>48,675</b>	<b>30,225</b>	<b>33,350</b>	<b>36,665</b>	<b>40,105</b>
<b>(2)</b>	Seattle Arm, COM cushions, leather frame						20 ¼	201		28,200		34,070	35,990	36,750				
<b>(Model #3)</b>	Phoenix Arm, fully upholstered						35 ¾	483	<b>26,705</b>	<b>28,035</b>	<b>30,210</b>	<b>42,715</b>	<b>46,935</b>	<b>48,635</b>	<b>30,060</b>	<b>33,180</b>	<b>36,495</b>	<b>39,950</b>
<b>(3)</b>	Phoenix Arm, COM cushions, leather frame						20 ¼	204		28,035		34,000	35,910	36,695				
<b>(Model #4)</b>	Dallas Arm, fully upholstered						35 ¾	489	<b>26,860</b>	<b>28,200</b>	<b>30,380</b>	<b>43,020</b>	<b>47,285</b>	<b>48,990</b>	<b>30,225</b>	<b>33,350</b>	<b>36,665</b>	<b>40,105</b>
<b>(4)</b>	Dallas Arm, COM cushions, leather frame						20 ¼	210		28,200		34,305	36,275	37,020				
<b>(Model #5)</b>	Miami Arm, fully upholstered						35 ¾	481	<b>26,705</b>	<b>28,035</b>	<b>30,210</b>	<b>42,910</b>	<b>47,175</b>	<b>48,885</b>	<b>30,060</b>	<b>33,180</b>	<b>36,495</b>	<b>39,950</b>
<b>(5)</b>	Miami Arm, COM cushions, leather frame						20 ¼	202		28,035		34,190	36,145	36,945				

Eden series passes CAL 133 certified for an upcharge of \$3400 list for seven seat. Certification applies to Nienkämper leathers and fabrics that have a minimum of 50% natural fibre content. COM's and COL's are subject to approval. Add the extension -CAL to the model number when ordering.

\*Add the width of the arms selected to the width of the sofa, see arm widths below right.

Back cushions have a foam core with Dacron wrap. Choose from two seat cushion fillings. Contract Filling is a firmer cushion. Residential Filling is a softer cushion. Both seat cushions are a combination of foam and down/feathers.

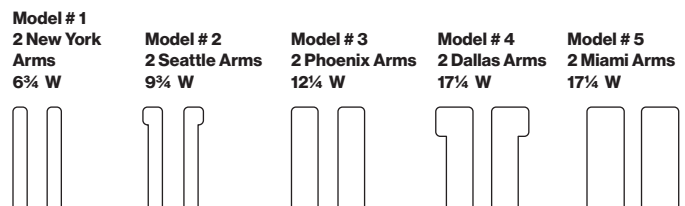

# LOUNGE SEATING

Eden® with Legs Designer – Nienkämper

— US Only —

Model Number	Seat H"	Arm H"	*does not include arms			Fabric Yds.	Leather Sq. Ft.	COM	COL	Neather	Verde	Grano	Cremoso	Knoll Textiles			
			W"	D"	H"									1	2	3	4

## SMALL LOUNGE



**1278\_** 17 24¼ 23½ 33 30¾  
COM cushions & frame  
2 ¼ yds 4 yds

<b>(Model #6)</b> New York Arm, fully upholstered	5 ⅓	82	<b>4,890</b>	<b>5,115</b>	<b>5,485</b>	<b>7,575</b>	<b>8,285</b>	<b>8,565</b>	<b>5,395</b>	<b>5,860</b>	<b>6,355</b>	<b>6,875</b>	<b>7,025</b>
<b>(6)</b> New York Arm, COM cushions, leather frame	2 ¼	52		5,115		6,475	6,875	7,025					
<b>(Model #7)</b> Seattle Arm, fully upholstered	5 ⅓	80	<b>5,130</b>	<b>5,385</b>	<b>5,760</b>	<b>7,895</b>	<b>8,630</b>	<b>8,935</b>	<b>5,660</b>	<b>6,160</b>	<b>6,685</b>	<b>7,235</b>	
<b>(7)</b> Seattle Arm, COM cushions, leather frame	2 ¼	50		5,385		6,765	7,205	7,380					
<b>(Model #8)</b> Boston Arm, fully upholstered	5 ⅓	85	<b>4,990</b>	<b>5,235</b>	<b>5,620</b>	<b>7,830</b>	<b>8,570</b>	<b>8,880</b>	<b>5,525</b>	<b>6,020</b>	<b>6,545</b>	<b>7,095</b>	
<b>(8)</b> Boston Arm, COM cushions, leather frame	2 ¼	55		5,235		6,485	6,890	7,025					

## LARGE LOUNGE



**1290\_** 17 24¼ 27½ 33 30¾  
COM cushions & frame  
2 ⅔ yds 4 yds

<b>(Model #6)</b> New York Arm, fully upholstered	6	92	<b>4,890</b>	<b>5,115</b>	<b>5,515</b>	<b>7,770</b>	<b>8,520</b>	<b>8,820</b>	<b>5,455</b>	<b>5,980</b>	<b>6,545</b>	<b>7,120</b>	
<b>(6)</b> New York Arm, COM cushions, leather frame	2 ⅔	57		5,115		6,665	7,110	7,305					
<b>(Model #7)</b> Seattle Arm, fully upholstered	6 ¼	90	<b>5,130</b>	<b>5,385</b>	<b>5,825</b>	<b>8,075</b>	<b>8,865</b>	<b>9,180</b>	<b>5,720</b>	<b>6,265</b>	<b>6,855</b>	<b>7,450</b>	
<b>(7)</b> Seattle Arm, COM cushions, leather frame	2 ⅔	55		5,385		6,950	7,440	7,640					
<b>(Model #8)</b> Boston Arm, fully upholstered	6 ¼	95	<b>4,990</b>	<b>5,235</b>	<b>5,685</b>	<b>8,025</b>	<b>8,810</b>	<b>9,135</b>	<b>5,580</b>	<b>6,125</b>	<b>6,705</b>	<b>7,310</b>	
<b>(8)</b> Boston Arm, COM cushions, leather frame	2 ⅔	60		5,235		6,905	7,400	7,595					

## SMALL TWO SEAT SOFA

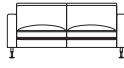

**1291\_** 17 24¼ 55 33 30¾  
COM cushions & frame  
5 ⅓ yds 6 yds

<b>(Model #6)</b> New York Arm, fully upholstered	10 ½	146	<b>7,405</b>	<b>7,770</b>	<b>8,340</b>	<b>11,895</b>	<b>13,085</b>	<b>13,545</b>	<b>8,395</b>	<b>9,310</b>	<b>10,290</b>	<b>11,300</b>	
<b>(6)</b> New York Arm, COM cushions, leather frame	5 ⅓	76		7,770		10,095	10,825	11,085					
<b>(Model #7)</b> Seattle Arm, fully upholstered	10 ½	140	<b>7,655</b>	<b>8,040</b>	<b>8,640</b>	<b>12,220</b>	<b>13,415</b>	<b>13,920</b>	<b>8,650</b>	<b>9,565</b>	<b>10,545</b>	<b>11,560</b>	
<b>(7)</b> Seattle Arm, COM cushions, leather frame	5 ⅓	74		8,040		10,430	11,165	11,455					
<b>(Model #8)</b> Boston Arm, fully upholstered	10 ½	149	<b>7,520</b>	<b>7,860</b>	<b>8,475</b>	<b>12,150</b>	<b>13,365</b>	<b>13,870</b>	<b>8,515</b>	<b>9,425</b>	<b>10,410</b>	<b>11,420</b>	
<b>(8)</b> Boston Arm, COM cushions, leather frame	5 ⅓	79		7,860		10,360	11,105	11,400					

Eden series passes CAL 133 certified for an upcharge of \$490 list per chair and \$975 list per two seater sofa. Certification applies to Nienkämper leathers and fabrics that have a minimum of 50% natural fibre content. COM's and COL's are subject to approval. Add the extension -CAL to the model number when ordering.

\*Add the width of the arms selected to the width of the sofa, see arm widths below right.

Back cushions have a foam core with Dacron wrap. Choose from two seat cushion fillings. Contract Filling is a firmer cushion. Residential Filling is a softer cushion. Both seat cushions are a combination of foam and down/feathers.

Model #12908  
Large Lounge



Model # 6  
2 New York Arms  
6¾ W



Model # 7  
2 Seattle Arms  
9¾ W

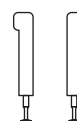

Model # 8  
2 Boston Arms  
10¾ W

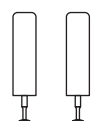

# LOUNGE SEATING

Eden® with Legs Designer – Nienkämper

— US Only —

Model Number	Seat Arm		*does not include arms			Fabric Yds.	Leather Sq. Ft.	COM	COL	Neather	Verde	Grano	Cremoso	Knoll Textiles			
	H"	H"	W"	D"	H"									1	2	3	4

## MEDIUM TWO SEAT SOFA



**1292\_** 17 24¼ 60½ 33 30¾

COM cushions & frame  
5 ½ yds 6 yds

<b>(Model #6)</b> New York Arm, fully upholstered	10½	151	<b>7,980</b>	<b>8,375</b>	<b>8,985</b>	<b>13,030</b>	<b>14,360</b>	<b>14,880</b>	<b>8,975</b>	<b>9,890</b>	<b>10,870</b>	<b>11,880</b>				
<b>(6)</b> New York Arm, COM cushions, leather frame	5⅓	78		8,375		10,895	11,650	11,980								
<b>(Model #7)</b> Seattle Arm, fully upholstered	10½	153	<b>8,240</b>	<b>8,665</b>	<b>9,280</b>	<b>13,370</b>	<b>14,740</b>	<b>15,260</b>	<b>9,230</b>	<b>10,145</b>	<b>11,125</b>	<b>12,145</b>				
<b>(7)</b> Seattle Arm, COM cushions, leather frame	5⅓	75		8,665		11,230	12,030	12,340								
<b>(Model #8)</b> Boston Arm, fully upholstered	10½	158	<b>8,100</b>	<b>8,505</b>	<b>9,145</b>	<b>13,310</b>	<b>14,655</b>	<b>15,210</b>	<b>9,090</b>	<b>10,005</b>	<b>10,990</b>	<b>12,000</b>				
<b>(8)</b> Boston Arm, COM cushions, leather frame	5⅓	80		8,505		11,170	11,970	12,300								

## LARGE TWO SEAT SOFA

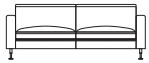

**1293\_** 17 24¼ 67 33 30¾

COM cushions & frame  
5 ½ yds 6 yds

<b>(Model #6)</b> New York Arm, fully upholstered	10½	166	<b>8,610</b>	<b>9,030</b>	<b>9,645</b>	<b>14,170</b>	<b>15,655</b>	<b>16,235</b>	<b>9,605</b>	<b>10,520</b>	<b>11,500</b>	<b>12,515</b>				
<b>(6)</b> New York Arm, COM cushions, leather frame	5⅓	86		9,030		11,705	12,530	12,865								
<b>(Model #7)</b> Seattle Arm, fully upholstered	10½	164	<b>8,865</b>	<b>9,310</b>	<b>9,950</b>	<b>14,535</b>	<b>16,010</b>	<b>16,600</b>	<b>9,860</b>	<b>10,770</b>	<b>11,755</b>	<b>12,765</b>				
<b>(7)</b> Seattle Arm, COM cushions, leather frame	5⅓	84		9,310		12,040	12,885	13,210								
<b>(Model #8)</b> Boston Arm, fully upholstered	10½	169	<b>8,705</b>	<b>9,145</b>	<b>9,790</b>	<b>14,425</b>	<b>15,930</b>	<b>16,535</b>	<b>9,705</b>	<b>10,625</b>	<b>11,605</b>	<b>12,615</b>				
<b>(8)</b> Boston Arm, COM cushions, leather frame	5⅓	89		9,145		11,970	12,810	13,160								

Eden series passes CAL 133 certified for an upcharge of \$975 list per two seater sofa. Certification applies to Nienkämper leathers and fabrics that have a minimum of 50% natural fibre content. COM's and COL's are subject to approval. Add the extension -CAL to the model number when ordering.

\*Add the width of the arms selected to the width of the sofa, see arm widths below right.

Back cushions have a foam core with Dacron wrap. Choose from two seat cushion fillings. Contract Filling is a firmer cushion. Residential Filling is a softer cushion. Both seat cushions are a combination of foam and down/feathers.

**Model #12938**  
Large two seat sofa



**Model # 6**  
2 New York Arms  
6¾ W



**Model # 7**  
2 Seattle Arms  
9¾ W

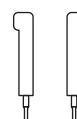

**Model # 8**  
2 Boston Arms  
10¾ W

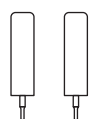

# LOUNGE SEATING

Eden® with Legs Designer – Nienkämper

Model Number	Seat Arm		* does not include arms			Fabric Yds.	Leather Sq. Ft.	COM	COL	Neather	Verde	Grano	Cremoso	— US Only — Knoll Textiles			
	H"	H"	W"	D"	H"									1	2	3	4

## THREE SEAT SOFA

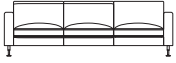

**1279\_** 17 24¼ 82¼ 33 30¾

COM cushions & frame  
8 yds 7 ½ yds

<b>(Model #6)</b> New York Arm, fully upholstered	14 ½	198	<b>10,240</b>	<b>10,755</b>	<b>11,700</b>	<b>17,155</b>	<b>18,990</b>	<b>19,725</b>	<b>11,610</b>	<b>12,870</b>	<b>14,225</b>	<b>15,625</b>
<b>(6)</b> New York Arm, COM cushions, leather frame	8	95	10,755	13,785	14,745	15,095						
<b>(Model #7)</b> Seattle Arm, fully upholstered	14 ½	195	<b>10,495</b>	<b>11,020</b>	<b>11,170</b>	<b>14,160</b>	<b>15,105</b>	<b>15,500</b>	<b>11,860</b>	<b>13,135</b>	<b>14,480</b>	<b>15,880</b>
<b>(7)</b> Seattle Arm, COM cushions, leather frame	8	92	11,020	21,225	22,345	22,800						
<b>(Model #8)</b> Boston Arm, fully upholstered	14 ½	201	<b>10,350</b>	<b>10,865</b>	<b>11,795</b>	<b>17,450</b>	<b>19,335</b>	<b>20,085</b>	<b>11,720</b>	<b>12,985</b>	<b>14,335</b>	<b>15,740</b>
<b>(8)</b> Boston Arm, COM cushions, leather frame	8	98	10,865	14,095	15,065	15,465						

Eden series passes CAL 133 certified for an upcharge of per three seat sofa. Certification applies to Nienkämper leathers and fabrics that have a minimum of 50% natural fibre content. COM's and COL's are subject to approval. Add the extension -CAL to the model number when ordering.

\*Add the width of the arms selected to the width of the sofa, see arm widths below right.

Back cushions have a foam core with Dacron wrap. Choose from two seat cushion fillings. Contract Filling is a firmer cushion. Residential Filling is a softer cushion. Both seat cushions are a combination of foam and down/feathers.

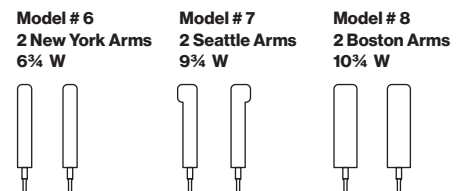

# LOUNGE SEATING

Eden® with Legs Designer – Nienkämper

— US Only —

Model Number	Seat H"	Arm H"	* does not include arms			Fabric Yds.	Leather Sq. Ft.	COM	COL	Neather	Verde	Grano	Cremoso	Knoll Textiles			
			W"	D"	H"									1	2	3	4

## SMALL OTTOMAN

	<b>12980</b>		27 ¼	19 ¾	17	2 ½	41	1,980	2,070	2,340	3,700	4,155	4,340	2,225	2,440	2,675	2,915
--	--------------	--	------	------	----	-----	----	-------	-------	-------	-------	-------	-------	-------	-------	-------	-------

## LARGE OTTOMAN

	<b>12990</b>		34 ¾	34 ¾	17	3 ½	50	2,415	2,540	2,855	4,480	5,015	5,245	2,755	3,060	3,385	3,720
--	--------------	--	------	------	----	-----	----	-------	-------	-------	-------	-------	-------	-------	-------	-------	-------

## LOUNGE WITH CLOSING ELEMENT

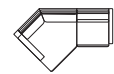
	<b>1294_</b>	17	24 ¼	83 ¾	56 ¼	30 ¾												
			COM cushions & frame															
			8 ⅔ yds 7 yds															
Left closing element	<b>(Model #6)</b> New York Arm, fully upholstered	13	213	<b>13,230</b>	<b>13,905</b>	<b>14,685</b>	<b>20,160</b>	<b>21,995</b>	<b>22,710</b>	<b>14,465</b>	<b>15,600</b>	<b>16,815</b>	<b>18,070</b>					
	<b>(6)</b> New York Arm, COM cushions, leather frame	6 ¾	93		13,905		16,685	17,590	17,945									
	<b>(Model #7)</b> Seattle Arm, fully upholstered	13 ½	212	<b>13,510</b>	<b>14,165</b>	<b>15,005</b>	<b>20,490</b>	<b>22,330</b>	<b>23,070</b>	<b>14,765</b>	<b>15,935</b>	<b>17,175</b>	<b>18,460</b>					
	<b>(7)</b> Seattle Arm, COM cushions, leather frame	6 ¾	93		14,165		17,020	17,945	18,320									
	<b>(Model #8)</b> Boston Arm, fully upholstered	13 ½	215	<b>13,345</b>	<b>14,000</b>	<b>14,840</b>	<b>20,410</b>	<b>22,285</b>	<b>23,025</b>	<b>14,610</b>	<b>15,770</b>	<b>17,010</b>	<b>18,295</b>					
	<b>(8)</b> Boston Arm, COM cushions, leather frame	6 ¾	96		14,000		18,035	17,890	18,255									

## SMALL TWO SEAT WITH CLOSING ELEMENT

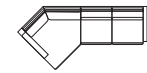
	<b>1295_</b>	17	24 ¼	111 ¼	56 ¼	30 ¾												
			COM cushions & frame															
			8 yds 9 ⅔ yds															
Left closing element	<b>(Model #6)</b> New York Arm, fully upholstered	17	267	<b>15,760</b>	<b>16,540</b>	<b>17,670</b>	<b>24,135</b>	<b>26,370</b>	<b>27,220</b>	<b>17,365</b>	<b>18,845</b>	<b>20,430</b>	<b>22,075</b>					
	<b>(6)</b> New York Arm, COM cushions, leather frame	8	112		16,540		19,795	20,855	21,280									
	<b>(Model #7)</b> Seattle Arm, fully upholstered	17 ½	264	<b>16,020</b>	<b>16,825</b>	<b>17,965</b>	<b>24,490</b>	<b>26,710</b>	<b>27,600</b>	<b>17,660</b>	<b>19,170</b>	<b>20,780</b>	<b>22,455</b>					
	<b>(7)</b> Seattle Arm, COM cushions, leather frame	8	110		16,825		20,150	21,225	21,660									
	<b>(Model #8)</b> Boston Arm, fully upholstered	17 ½	269	<b>15,870</b>	<b>16,660</b>	<b>17,815</b>	<b>24,395</b>	<b>26,635</b>	<b>27,545</b>	<b>17,505</b>	<b>19,025</b>	<b>20,635</b>	<b>22,310</b>					
	<b>(8)</b> Boston Arm, COM cushions, leather frame	8	114		16,660		20,055	21,170	21,600									

Eden series passes CAL 133 certified for an upcharge of \$485 list per ottoman. Certification applies to Nienkämper leathers and fabrics that have a minimum of 50% natural fibre content. COM's and COL's are subject to approval. Add the extension -CAL to the model number when ordering.

\*Add the width of the arm selected to the width of the sofa, see arm widths below right.

Back cushions have a foam core with Dacron wrap. Choose from two seat cushion fillings. Contract Filling is a firmer cushion. Residential Filling is a softer cushion. Both seat cushions are a combination of foam and down/feathers.

### Model #12958 Small two seat with closing element



**Model # 6**  
1 New York Arm  
3 ¾ W



**Model # 7**  
1 Seattle Arm  
4 ¾ W



**Model # 8**  
1 Boston Arm  
5 ½ W



# LOUNGE SEATING

Elite Designer - Nienkämper

— US Only —  
KnollTextiles

Model Number	Seat H"	W"	D"	H"	Fabric		COM	COL	Neather	Verde	Grano	Cremoso	KnollTextiles			
					Yds.	Sq.Ft.							1	2	3	4

## ELITE CHAIR WITH FIXED BASE



15411	17	28	27½	30	2¾	50	3,195	3,360	3,460	4,685	4,930	5,050	3,460	3,700	3,955	4,225
-------	----	----	-----	----	----	----	-------	-------	-------	-------	-------	-------	-------	-------	-------	-------

## ELITE CHAIR WITH SWIVEL BASE

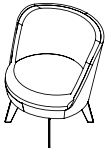

15412	17	28	27½	31¼	2¾	50	3,805	3,960	4,060	5,290	5,535	5,650	4,060	4,295	4,565	4,820
-------	----	----	-----	-----	----	----	-------	-------	-------	-------	-------	-------	-------	-------	-------	-------

Model # 15411



### Standard features:

- Interior clearance of the seat is 24"W x 20"D
- back with 2" thick lumbar foam wedge
- swivel base is standard with 180 degree swivel and memory return
- steel base is standard in Silver powder coat PC-01 or Black powder coat PC-06



# LOUNGE SEATING

Expo 67 Chair Designer - Christen Sorensen

— US Only —

Model Number	Seat H"	W"	D"	H"	Fabric		COM	COL	Neather	Verde	Grano	Cremoso	Knoll Textiles			
					Yds.	Sq.Ft.							1	2	3	4

## EXPO 67 CHAIR



<b>10264</b>	16	31	27	30½	1¼	23	2,920	3,075	3,040	3,655	3,765	3,820	3,040	3,145	3,270	3,385
--------------	----	----	----	-----	----	----	-------	-------	-------	-------	-------	-------	-------	-------	-------	-------

Model # 10264



### Standard features:

- Moulded plywood frame in natural beech veneer finish
- Seat and back cushions with polyurethane foam
- Polished aluminum swivel base on glides

# LOUNGE SEATING

Godbout Designer – charles godbout

— US Only —

Model Number	Seat H"	Arm H"	W"	D"	H"	Fabric Yds.	Leather Sq.Ft.	COM	COL	Verde	Grano	Cremoso	Knoll Textiles			
													1	2	3	4

## LOUNGE CHAIR

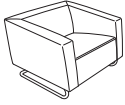

<b>12201</b>	14	22½	33	30	25¼	4	75	4,715	4,960	6,995	7,650	7,895	5,100	5,445	5,820	6,210
--------------	----	-----	----	----	-----	---	----	-------	-------	-------	-------	-------	-------	-------	-------	-------

## TWO SEAT SOFA

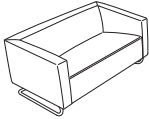

<b>12202</b>	14	22½	56	30	25¼	6	110	5,800	6,100	9,165	10,105	10,470	6,365	6,890	7,450	8,030
--------------	----	-----	----	----	-----	---	-----	-------	-------	-------	--------	--------	-------	-------	-------	-------

## THREE SEAT SOFA

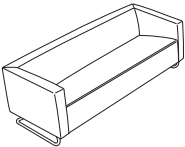

<b>12203</b>	14	22½	82	30	25¼	7½	140	6,980	7,335	11,275	12,470	12,935	7,690	8,345	9,040	9,765
--------------	----	-----	----	----	-----	----	-----	-------	-------	--------	--------	--------	-------	-------	-------	-------

### Standard Features

- Plywood frame construction
- Seat and back are webbed
- Polyurethane foam
- Fortrel® on seat, back and arms
- Reinforced tubular steel base in chrome powder coat finish

Distinct faceted look in contemporary style and comfort with a sweeping tubular base.

# LOUNGE SEATING

HAB™ Designer – brigitte shim and howard sutcliffe

Model Number	Seat H"	Arm H"	W"	D"	H"	Fabric Yds.	Leather Sq. Ft.	COM	COL	Verde	Grano	Creoso
<b>CHAIR</b>												
	<b>13201</b>	Wood										
	15	23½	35½	30¼	32½	3	40	4,430				
	<b>13202</b>	With upholstered seat and back pad										
							12	4,870	5,325	5,430	5,480	
	<b>13203</b>	With upholstered arm pad										
		Seat and back pad only										
							11	4,770	5,180	5,285	5,330	
		Arm pad only										
								490	920	1,040	1,080	
								375	785	900	920	



The HAB™ Chair is available in veneered molded plywood with upholstered pad for seat and back in leather, fabric or vinyl and a steel base.

The HAB™ Chair is perfect for large public spaces, as it commands a presence and is a beautiful piece of sculptured-looking wood whether approached from the front or back.

# LOUNGE SEATING

Heartbeat Designer - Karim Rashid

— US Only —

Model Number	Seat H"	Arm H"	W"	D"	H"	Fabric		COM	COL	Neather	Verde	Grano	Cremoso	Knoll Textiles			
						Yds.	Sq.Ft.							1	2	3	4

## HEARTBEAT CONVEX ELEMENT



10401	17		51	37 $\frac{3}{4}$	31 $\frac{1}{2}$	5 $\frac{1}{2}$	130	4,280	4,500					4,805	5,280	5,800	6,330
-------	----	--	----	------------------	------------------	-----------------	-----	-------	-------	--	--	--	--	-------	-------	-------	-------

## HEARTBEAT CONCAVE ELEMENT

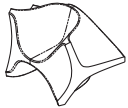

10402	17		54 $\frac{1}{4}$	32	31 $\frac{1}{2}$	5 $\frac{1}{2}$	130	4,280	4,500					4,760	5,195	5,655	6,140
-------	----	--	------------------	----	------------------	-----------------	-----	-------	-------	--	--	--	--	-------	-------	-------	-------

## HEARTBEAT STRAIGHT ELEMENT

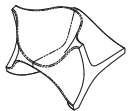

10403	17		40	35	31 $\frac{1}{2}$	5 $\frac{1}{2}$	130	4,070	4,275					4,595	5,070	5,590	6,120
-------	----	--	----	----	------------------	-----------------	-----	-------	-------	--	--	--	--	-------	-------	-------	-------

## HEARTBEAT CONVEX TABLE ELEMENT

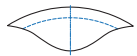

	Finish	W"	D"	Thickness"	
10404/2	Veneer	35 $\frac{9}{16}$	12 $\frac{3}{8}$	1 $\frac{1}{4}$	1,320
10404/5	P-Lam	35 $\frac{9}{16}$	12 $\frac{3}{8}$	1 $\frac{1}{4}$	1,175

## HEARTBEAT CONCAVE TABLE ELEMENT

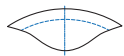

10405/2	Veneer	32 $\frac{9}{16}$	11 $\frac{13}{16}$	1 $\frac{1}{4}$	1,320
10405/5	P-Lam	32 $\frac{9}{16}$	11 $\frac{13}{16}$	1 $\frac{1}{4}$	1,175

### Standard features:

- Rigid core frame with durable foam cover.
- Convex/Concave/Straight sofa elements can be arranged in limitless quantity and configuration to create double sided seating.
- Optional Convex/Concave table element with 3" taper edge mounts between sofa elements to frame with metal support.
- Optional dual USB Charger can be added to underside of table.

### Note:

Fabric with 4 way stretch is recommended on Heartbeat chair, COM should be approved by Nienkämper factory.



# LOUNGE SEATING

Heartbeat Designer - Karim Rashid

## Heartbeat Layout

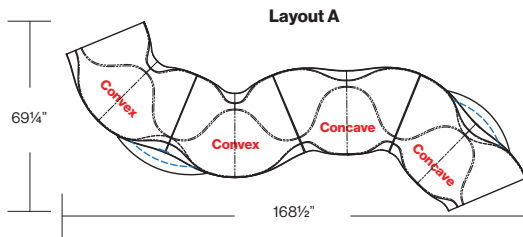
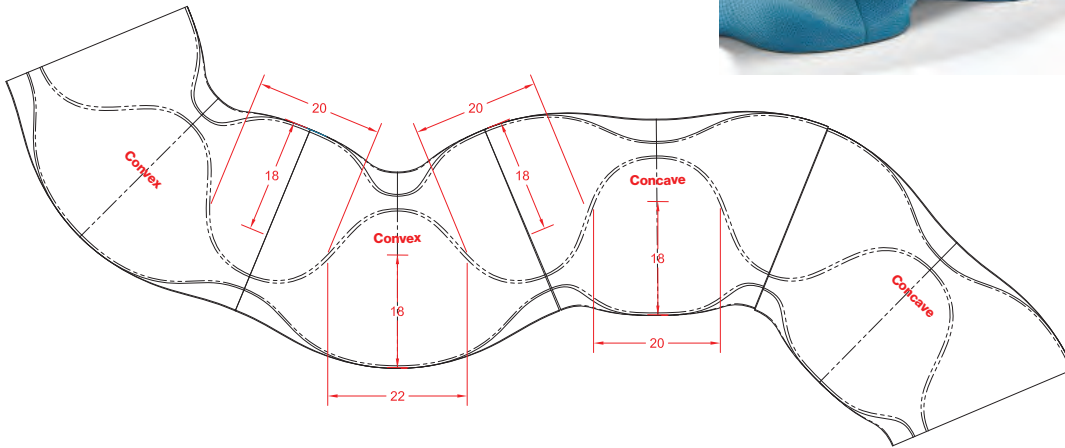
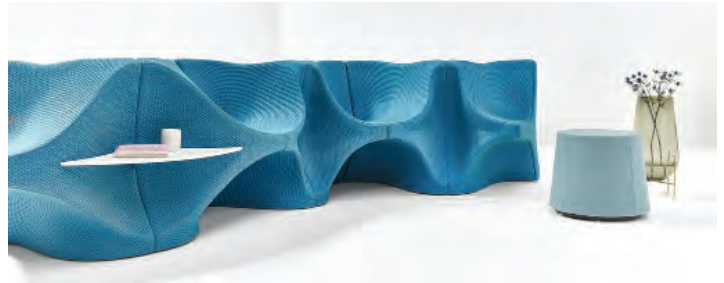

**Layout "A" consists of:**  
 4 Sofa Elements & 2 Table Elements providing a total of 7 Seats  
 From left to right: Convex Sofa Element #10401, Convex Table Element #10404/5, Convex Sofa Element #10401, Concave Sofa Element #10402, Concave Sofa Element #10402, Concave Table Element #10405/5

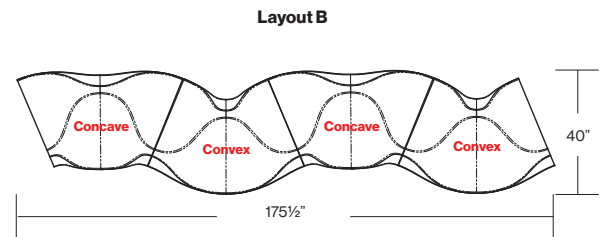

**Layout "B" consists of:**  
 4 Sofa Elements providing a total of 7 Seats  
 From left to right: Concave Sofa Element #10402, Convex Sofa Element #10401, Concave Sofa Element #10402, Convex Sofa Element #10401

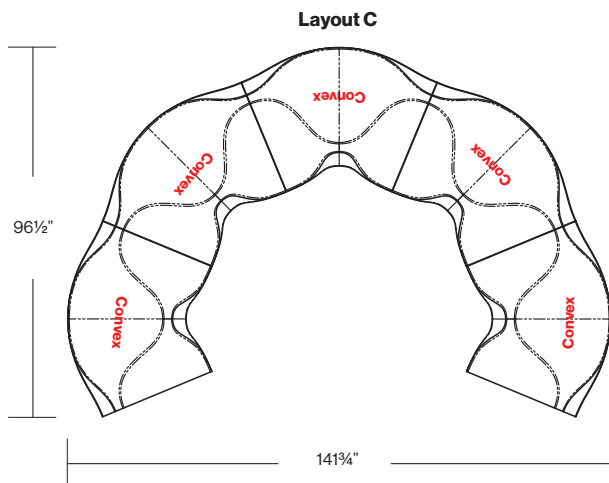

**Layout "C" consists of:**  
 5 Sofa Elements providing a total of 9 Seats  
 From left to right: Convex Sofa Element #10401, Convex Sofa Element #10401, Convex Sofa Element #10401, Convex Sofa Element #10401, Convex Sofa Element #10401

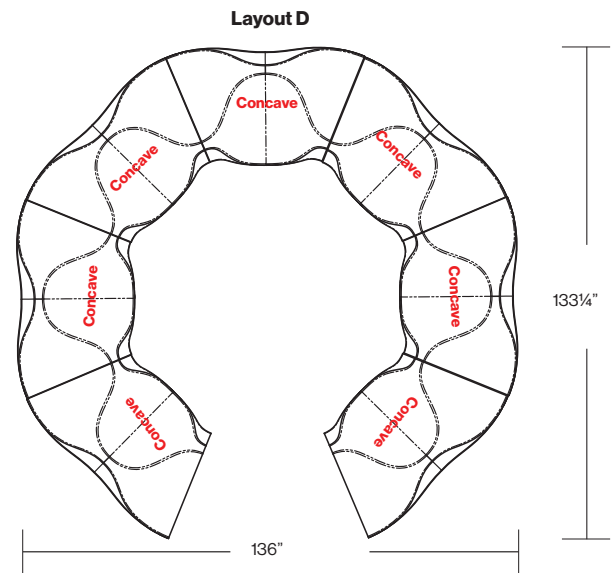

**Layout "D" consists of:**  
 7 Sofa Elements providing a total of 13 Seats  
 From left to right: Concave Sofa Element #10402, Concave Sofa Element #10402, Concave Sofa Element #10402, Concave Sofa Element #10402, Concave Sofa Element #10402, Concave Sofa Element #10402, Concave Sofa Element #10402

# LOUNGE SEATING

Ingmar Chair on Legs Designer – nienkämper

Model Number	Seat Arm			D"	H"	Fabric Yds.	Leather Sq.Ft.	COM	COL	Verde	Grano	Cremoso	— US Only — Knoll Textiles			
	H"	H"	W"										1	2	3	4

## INGMAR CHAIR WITH CHANNEL SLING



<b>13901</b>	16 ½	21 ½	25	26	34 ½	1 ½	18	3,375	3,545	4,035	4,140	4,185	3,515	3,650	3,790	3,935
--------------	------	------	----	----	------	-----	----	-------	-------	-------	-------	-------	-------	-------	-------	-------

## INGMAR CHAIR WITH SADDLE LEATHER SLING



<b>13902</b>	16 ½	21 ½	25	26	34 ½	1 ½	18	specify Brown (IVT05) or Black (IVT06)							
								3,810							

## INGMAR CHAIR WITH MESH SLING



<b>13903</b>	16 ½	21 ½	25	26	34 ½	1 ½	18	specify Black (IM01), Racing Green (IM02), or Beige (IM03)							
								2,940							

### Standard Features

- natural cherry, maple or walnut frame
- stained to match available: wood finish available in standard Nienkämper
- stains; to match custom stain add \$600 list per each stain colour
- channel sling available in fabrics and leathers
- saddle leather sling available in Brown (IVT05) or Black (IVT06)
- mesh sling available in Black (IM01), Racing Green (IM02) or Beige (IM03)

**Model # 13901**  
Ingmar with Padded Sling



**Model # 13902**  
Ingmar with Saddle Leather Sling



**Model # 13903**  
Ingmar with Mesh Sling



# LOUNGE SEATING

Isola 8 Designer – Karim Rashid

— US Only —

Model Number	Seat H"	W"	D"	H"	Fabric Yds.	Leather Sq. Ft.	COM	COL	Verde	Grano	Cremoso	Knoll Textiles			
												1	2	3	4

## ISOLA 8

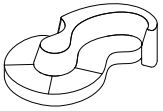

### 10210

Fully	16	110	70	32	15½	126	14,680	15,425	22,275	24,795	25,645	16,145	17,495	18,945	20,435
Back					8½	153									
Seat					7	280									

### Frame:

FSC plywood.

### Seat and Back:

Soy based foam and fortrel.

### Base:



FSC Mdf Base.



# LOUNGE SEATING

J + J Studio Sofa Designer - MSDS Studio

— US Only —

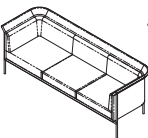
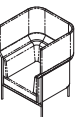
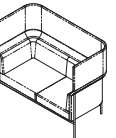
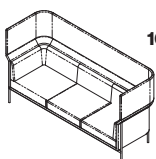
Model Number	Seat H"	W"	D"	H"	Fabric Leather		COM	COL	Neather	Verde	Grano	Cremoso	Knoll Textiles					
					Yds.	Sq. Ft.							1	2	3	4		
<b>J + J STUDIO LOW BACK LOUNGE CHAIR</b>																		
	10271	17	35	30 3/4	33	Fully upholstered	6	108	4,915	5,165	5,480	8,025	8,550	8,805	5,485	6,010	6,570	7,150
						COM cushions, leather frame	3	52		5,165		6,590	6,865	6,985				
<b>J + J STUDIO LOW BACK 2 SEAT SOFA</b>																		
	10272	17	59	30 3/4	33	Fully upholstered	8 1/2	153	7,180	7,540	7,970	11,600	12,340	12,715	7,990	8,730	9,520	10,335
						COM cushions, leather frame	4 1/4	75		7,540		9,585	9,960	10,140				
<b>J + J STUDIO LOW BACK 3 SEAT SOFA</b>																		
	10273	17	85	30 3/4	33	Fully upholstered	11 3/4	212	8,660	9,090	9,745	14,715	15,735	16,240	9,775	10,790	11,890	13,030
						COM cushions, leather frame	6 3/4	90		9,090		11,480	11,910	12,130				
<b>J + J STUDIO HIGH BACK LOUNGE CHAIR</b>																		
	10275	17	35	30 3/4	49	Fully upholstered	8 1/4	149	5,905	6,190	6,675	10,140	10,865	11,220	6,680	7,405	8,175	8,970
						COM cushions, leather frame	3	95		6,190		8,705	9,170	9,400				
<b>J + J STUDIO HIGH BACK 2 SEAT SOFA</b>																		
	10276	17	59	30 3/4	49	Fully upholstered	11 1/2	207	8,620	9,045	9,690	14,535	15,530	16,030	9,700	10,705	11,780	12,890
						COM cushions, leather frame	4 1/4	130		9,045		12,495	13,120	13,425				
<b>J + J STUDIO HIGH BACK 3 SEAT SOFA</b>																		
	10277	17	85	30 3/4	49	Fully upholstered	15 1/4	275	10,385	10,905	11,800	18,205	19,530	20,190	11,830	13,160	14,585	16,050
						COM cushions, leather frame	6 3/4	153		10,905		14,970	15,705	16,065				

**Standard features:**

- Solid maple and plywood construction frame wrapped with foam
- Seat and back cushions have molded foam inside and wrapped in Dacron.
- Exposed steel frame available in clear coated raw finish, polished chrome, brushed chrome and black powder coat finish.

Model # 10277 J & J Studio high back 3 seat sofa



Model # 10273 J & J Studio low back 3 seat sofa



Frame upholstered in Ecopell leather, Blueberry EC700



# LOUNGE SEATING

Kloud® Designer – Karim Rashid

— US Only —

Model Number	Seat Arm		W"	D"	H"	Fabric Leather		COM	COL	Verde	Grano	Cremoso	Knoll Textiles			
	H"	H"				Yds.	Sq.Ft.						1	2	3	4

## CHAIR



Fully upholstered  
**14981**

17 24½ 38 28½ 31 4½ 81

2,955 3,105 5,370 6,005 6,265 3,380 3,770 4,190 4,630

## TWO SEAT SOFA

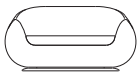

Fully upholstered  
**14984**

17 24½ 63 28½ 31 6 108

5,115 5,370 8,175 9,255 9,975 5,685 6,210 6,770 7,345

## THREE SEAT SOFA

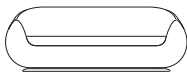

Fully upholstered  
**14987**

17 24½ 86 28½ 31 7½ 135

7,560 7,940 11,470 12,850 13,580 8,270 8,925 9,625 10,350

**Kloud Collection passes CAL 133 certified for an upcharge of \$435 list per chair, \$870 list per 2 seat sofa and \$1,240 list per 3 seat sofa. Certification applies to Nienkämper leathers and fabrics that have a minimum of 50% natural fibre content. COM's and COL's are subject to approval. Add the extension -CAL to the model number when ordering.**

Laminated wood base frame with rubber webbing under the fixed cushion. The foam body is supported with a tubular steel frame inside.

The seat and back are polyurethane foam covered in Fortrel®. Upholstered in leather or fabric.

The swivel base is painted silver. The swivel base can be upholstered to match the frame;  
add ⅓ yds 6 sq. ft. chair  
add ⅔ yds 12 sq. ft. two seat sofa  
add 1⅓ yds 18 sq. ft. three seat sofa





The curvaceous shape and soft molded foam of the Kloud chair are conducive to fabrics with some stretch and minimum pattern. COM fabrics should be approved by customer service. (800.668.9318)

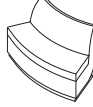
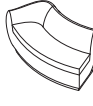

# LOUNGE SEATING

Kloud® Serpentine™ Designer – Karim Rashid

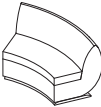
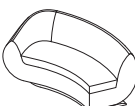
— US Only —

	Model Number	Seat H"	Arm H"	W"	D"	H"	Fabric Yds.	Leather Sq. Ft.	COM	COL	Verde	Grano	Cremoso	Knoll Textiles			
														1	2	3	4
<b>CONVEX</b>																	
<b>Right end</b>	<b>14994</b>	17	25¾	73	28½	30½	6¾	122	4,785	5,010	8,255	9,550	9,950	5,425	6,010	6,645	7,295
																	
<b>Centre element</b>	<b>14991</b>	17		54	28½	30½	4¾	86	3,160	3,320	5,610	6,530	6,800	3,610	4,025	4,465	4,920
																	
<b>Left end</b>	<b>14993</b>	17	25¾	73	28½	30½	6¾	122	4,785	5,010	8,255	9,550	9,950	5,425	6,010	6,645	7,295
																	
<b>CONCAVE</b>																	
<b>Right end</b>	<b>14997</b>	17	25¾	67	28½	30½	7	126	5,085	5,330	8,675	10,005	10,415	5,750	6,355	7,005	7,685
																	
<b>Centre element</b>	<b>14992</b>	17		52	28½	30½	5	90	3,495	3,675	6,080	7,015	7,325	3,960	4,400	4,870	5,350
																	
<b>Left end</b>	<b>14996</b>	17	25¾	67	28½	30½	7	126	5,085	5,330	8,675	10,005	10,415	5,750	6,355	7,005	7,685
																	
<b>STRAIGHT</b>																	
<b>Left end</b>	<b>14995</b>	17		24	28½	30½	2½	45	2,915	3,055	3,590	3,845	3,930	3,150	3,370	3,600	3,845
																	

**Frame:**

Laminated wood base frame with rubber webbing under the fixed cushion. The foam body is supported with a tubular steel frame inside.

**Seat and Back:**

The seat and back are polyurethane foam, seat covered in Fortrel®. Upholstered in leather or fabric.

**Base:**

The base is painted silver.

The curvaceous shape and soft molded foam of the Kloud chair are conducive to fabrics with some stretch and minimum pattern. COM fabrics should be approved by customer service. (800.668.9318)

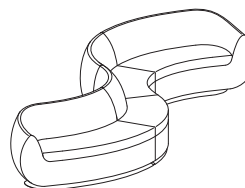

**Consists of (from Left to Right when facing) :**

- 1 x **14993** Convex Left End
- 1 x **14991** Convex Centre Element
- 1 x **14992** Concave Centre Element
- 1 x **14997** Concave Right End

# LOUNGE SEATING

LCS Club Designer – Nienkamper

— US Only —

Model Number	Seat H"	W"	D"	H"	Fabric Yds.	Leather Sq. Ft.	COM	COL	Neather	Verde	Grano	Cremoso	Knoll Textiles			
													1	2	3	4

## LCS CLUB CHAIR

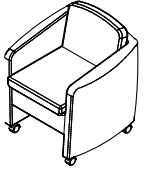

<b>11005</b>	15	30	31	26	6.75	120	3,080	3,240		6,505	6,915	7,325	3,380	3,650	3,925	4,230
--------------	----	----	----	----	------	-----	-------	-------	--	-------	-------	-------	-------	-------	-------	-------

**Model # 11005  
LCS Club Chair**



### Standard Features

- The reclining feature that allows for the seat and back to change simply by leaning back. Casters allow the chair to move freely.

# LOUNGE SEATING

Leaf Designer - busk + hertzog

— US Only —

Model Number	Seat H"	Arm H"	W"	D"	H"	Fabric Yds.	Leather Sq.Ft.	COM	COL	Neather	Verde	Grano	Cremoso	Knoll Textiles			
														1	2	3	4

## LEAF CHAIR



10310	17		36½	28	25¼	2½	45	3,245	3,395	3,450	4,380	4,580	4,675	3,485	3,700	3,930	4,175
-------	----	--	-----	----	-----	----	----	-------	-------	-------	-------	-------	-------	-------	-------	-------	-------

Model # 10310



### Standard features:

- Seat with plywood shell
- Soy based flexible polyurethane foam for seat & back
- Polished chrome base

Fabric to be upholstered on Leaf Chair needs to be approved by Nienkämper Factory, please contact Customer Service at 800 668 9318 for our fabric approval list.



# LOUNGE SEATING

LINQ Designer - Nienkämper

— US Only —

Model Number	Seat H"	W"	D"	H"	Fabric Yds.	Leather Sq.Ft.	COM	COL	Neather	Verde	Grano	Cremoso	Knoll Textiles			
													1	2	3	4

## LINQ SEAT WITH BACK MODULE

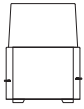

<b>10911</b>	16 ½	22	32	29 ½	3	54	2,295	2,400	2,570	3,765	4,250	4,410	2,580	2,835	3,125	3,410
--------------	------	----	----	------	---	----	-------	-------	-------	-------	-------	-------	-------	-------	-------	-------

## LINQ SEAT MODULE



<b>10912</b>		22	26	16 ½	2 ¼	40	1,375	1,470	1,590	2,465	2,830	2,950	1,590	1,780	1,985	2,205
--------------	--	----	----	------	-----	----	-------	-------	-------	-------	-------	-------	-------	-------	-------	-------

## LINQ ARM



<b>10913</b>		5 ½	26	21	1 ½	27	945	1,040	1,095	1,690	1,930	2,015	1,090	1,225	1,365	1,510
--------------	--	-----	----	----	-----	----	-----	-------	-------	-------	-------	-------	-------	-------	-------	-------

## LINQ TABLE



<b>10915</b>		22	26	12 ¼												
--------------	--	----	----	------	--	--	--	--	--	--	--	--	--	--	--	--

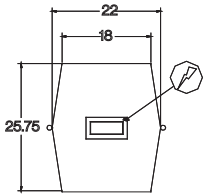

### Paint

4,330

### Wood

5,610

## SIMPLE POP UP FORUM

(4 power pre-wired with 72 cord)

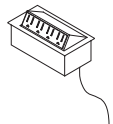

**8174**

885

Frame is constructed of FSC Plywood core with molded foam. Any number of the three modules or table can be combined for different effects. The flexible hinge mechanism allows easy reconfiguration into any combination of straight, concave or convex layouts.

The table is available in white, silver, or black paint finish or any standard wood veneer and finishes.

Contact Customer Services at 800 668 9318 for options of other Simple Pop-up Forum

### LINQ Sofa

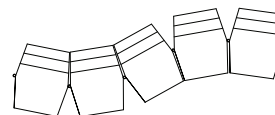
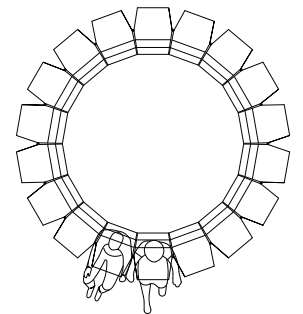
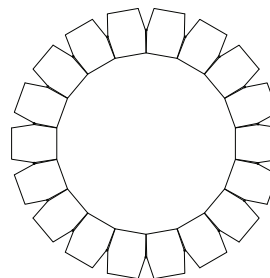

# LOUNGE SEATING

LolliPOP Designer - Robin Bush 1960

— US Only —

Model Number	Seat H"	W"	D"	H"	Fabric Yds.	Leather Sq.Ft.	COM	COL	Neather	Verde	Grano	Cremoso	Knoll Textiles			
													1	2	3	4

## LOLLIPOP 2 SEATER

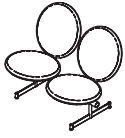

<b>10252</b>	18	45	33	34	3	54											
					Seat	1¼	23										
					Back	1¾	32										

4,770	5,010	5,055	6,465	6,740	6,880	5,050	5,315	5,595	5,890
-------	-------	-------	-------	-------	-------	-------	-------	-------	-------

## LOLLIPOP 3 SEATER



<b>10253</b>	18	69	33	34	4½	81											
					Seat	1¾	32										
					Back	2¾	50										

6,055	6,355	6,490	8,535	8,950	9,150	6,485	6,880	7,300	7,735
-------	-------	-------	-------	-------	-------	-------	-------	-------	-------

## LOLLIPOP 4 SEATER



<b>10254</b>	18	93	33	34	6	108											
					Seat	2½	45										
					Back	3½	63										

7,275	7,630	7,840	10,530	11,080	11,355	7,845	8,365	8,925	9,510
-------	-------	-------	--------	--------	--------	-------	-------	-------	-------

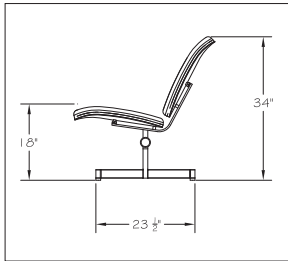

Side elevation

Model # 10252  
LolliPOP 2 Seater



Model # 10253  
LolliPOP 3 Seater front



Model # 10253  
LolliPOP 3 Seater back



Model # 10254  
LolliPOP 4 Seater



### Standard Features:

- Each seat: 21" w x 22" d
- Plywood seat pan with soy based polyurethane foam
- Metal base with black powder coat horizontal steel bar and brushed nickel foot

# LOUNGE SEATING

Lucerne Designer – Robert Haussmann

— US Only —

Model Number	Seat H"	Arm H"	W"	D"	H"	Fabric Yds.	Leather Sq. Ft.	COM	COL	Verde	Grano	Cremoso	Knoll Textiles			
													1	2	3	4

## LOUNGE CHAIR



<b>302</b>	19½	25½	36	31¾	30½	6	105	8,175	8,570	12,110	13,145	13,545	8,745	9,260	9,825	10,405
------------	-----	-----	----	-----	-----	---	-----	-------	-------	--------	--------	--------	-------	-------	-------	--------

## TWO SEAT SOFA



<b>302-2</b>	19½	25½	60	31¾	30½	9½	163	12,400	13,010	18,500	20,110	20,755	13,295	14,125	15,010	15,930
--------------	-----	-----	----	-----	-----	----	-----	--------	--------	--------	--------	--------	--------	--------	--------	--------

## THREE SEAT SOFA

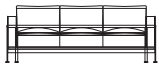

<b>302-3</b>	19½	25½	84	31¾	30½	12½	221	16,730	17,570	25,010	27,180	28,055	17,910	19,000	20,160	21,370
--------------	-----	-----	----	-----	-----	-----	-----	--------	--------	--------	--------	--------	--------	--------	--------	--------

Model #302



The solid bar stock steel frame is finished in mirror polished chrome. Loose seat and back cushions are down filled.

Model #302-2



# LOUNGE SEATING

Max™ Designer – mark müller

— US Only —

Model Number	Seat H"	Arm		D"	H"	Fabric Yds.	Leather Sq.Ft.	COM	COL	Neather	Verde	Grano	Cremoso	KnollTextiles			
		H"	W"											1	2	3	4

## ARMLESS LOUNGE CHAIR



<b>1110</b>	16 ½		23	33	29	2 ½	42	2,780	2,925	3,070	4,350	4,770	4,945	3,015	3,235	3,465	3,710
-------------	------	--	----	----	----	-----	----	-------	-------	-------	-------	-------	-------	-------	-------	-------	-------

## LOUNGE CHAIR



<b>1111_</b>	16 ½	24 ½	33 ½	33	29													
<b>(Model #1)</b> Closed upholstered arm						<b>78</b>		<b>4,620</b>	<b>4,870</b>	<b>5,250</b>	<b>7,555</b>	<b>8,320</b>	<b>8,630</b>	<b>5,145</b>	<b>5,620</b>	<b>6,140</b>	<b>6,670</b>	
<b>(Model #4)</b> Open wood arm						42		3,670	3,845	3,950	5,245	5,655	5,810	3,910	4,125	4,355	4,600	
<b>(Model #5)</b> Wood arm, upholstered panel						<b>73</b>		<b>4,200</b>	<b>4,410</b>	<b>4,815</b>	<b>6,930</b>	<b>7,650</b>	<b>7,940</b>	<b>4,715</b>	<b>5,200</b>	<b>5,715</b>	<b>6,240</b>	
<b>(Model #6)</b> Wood arm, wood panel						38		4,670	4,900	4,960	6,105	6,480	6,615	4,905	5,125	5,355	5,600	

wood level  
ebonized unless specified

## TWO SEAT SOFA

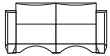

<b>1112_</b>	16 ½	24 ½	58	33	29													
<b>(Model #1)</b> Closed upholstered arm						<b>120</b>		<b>6,790</b>	<b>7,130</b>	<b>7,605</b>	<b>11,285</b>	<b>12,470</b>	<b>12,945</b>	<b>7,480</b>	<b>8,110</b>	<b>8,785</b>	<b>9,495</b>	
<b>(Model #4)</b> Open wood arm						80		5,810	6,110	6,285	8,795	9,595	9,905	6,215	6,580	6,980	7,385	
<b>(Model #5)</b> Wood arm, upholstered panel						<b>111</b>		<b>6,370</b>	<b>6,695</b>	<b>6,865</b>	<b>10,520</b>	<b>11,625</b>	<b>12,050</b>	<b>6,775</b>	<b>7,140</b>	<b>7,540</b>	<b>7,950</b>	
<b>(Model #6)</b> Wood arm, wood panel						76		6,860	7,180	7,320	9,690	10,430	10,730	7,260	7,630	8,025	8,435	

## THREE SEAT SOFA

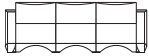

<b>1113_</b>	16 ½	24 ½	81	33	29													
<b>(Model #1)</b> Closed upholstered arm						<b>158</b>		<b>8,975</b>	<b>9,415</b>	<b>9,990</b>	<b>14,875</b>	<b>16,440</b>	<b>17,055</b>	<b>9,825</b>	<b>10,615</b>	<b>11,445</b>	<b>12,320</b>	
<b>(Model #4)</b> Open wood arm						118		7,980	8,375	8,655	12,405	13,555	14,025	8,550	9,070	9,630	10,210	
<b>(Model #5)</b> Wood arm, upholstered panel						<b>149</b>		<b>8,540</b>	<b>8,960</b>	<b>9,550</b>	<b>14,125</b>	<b>15,580</b>	<b>16,165</b>	<b>9,390</b>	<b>10,170</b>	<b>11,010</b>	<b>11,880</b>	
<b>(Model #6)</b> Wood arm, wood panel						114		9,025	9,465	9,695	13,295	14,405	14,850	9,595	10,120	10,680	11,265	

Arm width and height dimensions are based on Model # 1, the fully upholstered closed arm option. Wood arms, Model # 4, # 5, and # 6 are available in standard Nienkämper veneers and stains, refer to page 12 for a listing. Add \$600 list for each custom stain required.

The solid wood front foot on the upholstered arm, Model # 1, is available in standard Nienkämper veneers and stains or ebonized, refer to page 12 for a listing. To match custom stains add \$570 list per chair, for each stain colour. An optional solid wood rear foot detail (see illustration at right) is available in standard Nienkämper veneers and stains or ebonized, refer to page 12 for a listing. Add \$275 list per chair or sofa for the rear foot.

**Max series passes CAL 133 certified for an upcharge of \$435 list per chair, \$870 list per two seater sofa, and \$1305 list per three seat sofa. Certification applies to Nienkämper leathers and fabrics that have a minimum of 50% natural fibre content. COM's and COL's are subject to approval. Add the extension -CAL to the model number when ordering.**

Model # 11114 & # 11100



Model # 1  
Closed  
Upholstered Arm

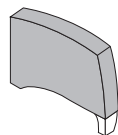

Model # 4  
Open  
Wood Arm



Model # 5  
Wood Arm  
Upholstered  
Panel

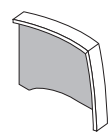

Model # 6  
Wood Arm  
Wood Panel

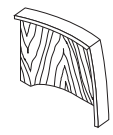

Closed Arm  
Optional Rear  
Wood Foot

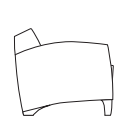

Open Arm  
Optional Rear  
Wood Foot





# LOUNGE SEATING

Max™ Designer – mark müller

— US Only —

Model Number	Seat H"	Arm H"	W"	D"	H"	Fabric Yds.	Leather Sq. Ft.	COM	COL	Neather	Verde	Grano	Cremoso	Knoll Textiles			
														1	2	3	4

## FOUR SEAT SOFA

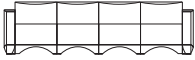

1114\_ 16½ 24½ 104 33 29

(Model #1) Closed upholstered arm	10¾	196	11,595	12,180	12,790	18,930	20,855	21,640	12,610	13,540	14,545	15,590
(Model #4) Open wood arm	7¾	156	10,620	11,130	11,490	16,445	17,995	18,610	11,340	12,020	12,750	13,495
(Model #5) Wood arm, upholstered panel	10¾	187	11,170	11,730	12,385	18,155	20,005	20,755	12,190	13,120	14,130	15,170
(Model #6) Wood arm, wood panel	7¾	152	11,635	12,210	12,515	17,325	18,820	19,425	12,370	13,045	13,770	14,515

## OTTOMAN



11300 16 23 23 16 1¾ 38

1,810	1,910	1,995	3,235	3,590	3,765	1,965	2,120	2,265	2,425
-------	-------	-------	-------	-------	-------	-------	-------	-------	-------



11100 16 28 28 16 2¾ 42

1,980	2,070	2,295	3,550	3,955	4,135	2,245	2,485	2,745	3,005
-------	-------	-------	-------	-------	-------	-------	-------	-------	-------

Max series passes CAL 133 certified for an upcharge of \$1825 list per four seat sofa, and \$400 list per ottoman. Certification applies to Nienkämper leathers and fabrics that have a minimum of 50% natural fibre content. COM's and COL's are subject to approval. Add the extension -CAL to the model number when ordering.

Arm width and height dimensions are based on Model # 1, the fully upholstered closed arm option. Wood arms, Model # 4, # 5, and # 6 are available in standard Nienkämper veneers and stains, refer to page 12 for a listing. Add \$600 list for each custom stain required.

The solid wood front foot on the upholstered arm, Model # 1, is available in standard Nienkämper veneers and stains or ebonized, refer to page 12 for a listing. To match custom stains add \$600 list per chair, for each stain colour. An optional solid wood rear foot detail (see illustration at right) is available in standard Nienkämper veneers and stains or ebonized, refer to page 12 for a listing. Add \$290 list per chair or sofa for the rear foot.

Model # 11131  
Three seat sofa with closed upholstered arm



Model # 1  
Closed Upholstered Arm

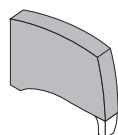

Model # 4  
Open Wood Arm



Model # 5  
Wood Arm Upholstered Panel

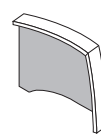

Model # 6  
Wood Arm Wood Panel

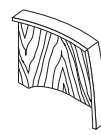

Closed Arm  
Optional Rear Wood Foot



Open Arm  
Optional Rear Wood Foot



# LOUNGE SEATING

Max™ Convex Designer – mark müller

— US Only —

Model Number	Seat H"	Arm H"	Front W"	Rear W"	D"	H"	Fabric Yds.	Leather Sq. Ft.	COM	COL	Neather	Verde	Grano	Cremoso	Knoll Textiles			
															1	2	3	4
<b>LOUNGE</b>																		
 <b>1121_</b>	16½	24¼	38½	29	34¾	29												
<b>(Model #1)</b> Closed upholstered arm							5¾	79	<b>5,235</b>	<b>5,485</b>	<b>5,895</b>	<b>8,185</b>	<b>8,960</b>	<b>9,265</b>	<b>5,785</b>	<b>6,280</b>	<b>6,815</b>	<b>7,375</b>
<b>(Model #4)</b> Open wood arm							2¾	42	4,255	4,465	4,565	5,815	6,300	6,395	4,510	4,760	5,015	5,275
<b>(Model #5)</b> Wood arm, upholstered panel							5¾	67	<b>4,810</b>	<b>5,055</b>	<b>5,475</b>	<b>7,325</b>	<b>7,980</b>	<b>8,240</b>	<b>5,355</b>	<b>5,855</b>	<b>6,390</b>	<b>6,950</b>
<b>(Model #6)</b> Wood arm, wood panel							2¾	39	5,280	5,535	5,580	6,740	7,125	7,300	5,545	5,785	6,040	6,310

## TWO SEAT SOFA

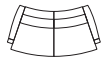

<b>1122_</b>	16½	24¼	67¼	49	37½	29												
<b>(Model #1)</b> Closed upholstered arm							7¾	118	<b>8,015</b>	<b>8,415</b>	<b>8,880</b>	<b>12,415</b>	<b>13,580</b>	<b>14,055</b>	<b>8,750</b>	<b>9,420</b>	<b>10,145</b>	<b>10,890</b>
<b>(Model #4)</b> Open wood arm							4¾	81	7,015	7,370	7,555	10,070	10,850	11,170	7,465	7,875	8,320	8,780
<b>(Model #5)</b> Wood arm, upholstered panel							7¾	106	<b>7,560</b>	<b>7,955</b>	<b>8,435</b>	<b>11,535</b>	<b>12,320</b>	<b>13,000</b>	<b>8,295</b>	<b>8,975</b>	<b>9,700</b>	<b>10,445</b>
<b>(Model #6)</b> Wood arm, wood panel							4¾	78	8,040	8,455	8,570	10,980	11,745	12,040	8,485	8,905	9,345	9,805

## THREE SEAT SOFA

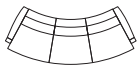

<b>1123_</b>	16½	24¼	93½	69¼	43¼	29												
<b>(Model #1)</b> Closed upholstered arm							9¾	157	<b>10,755</b>	<b>11,295</b>	<b>11,840</b>	<b>16,625</b>	<b>18,175</b>	<b>18,795</b>	<b>11,675</b>	<b>12,530</b>	<b>13,430</b>	<b>14,375</b>
<b>(Model #4)</b> Open wood arm							6¾	120	9,790	10,280	10,550	14,290	15,465	15,930	10,435	11,015	11,645	12,300
<b>(Model #5)</b> Wood arm, upholstered panel							9¾	145	<b>10,350</b>	<b>10,865</b>	<b>11,440</b>	<b>15,765</b>	<b>17,195</b>	<b>17,770</b>	<b>11,275</b>	<b>12,125</b>	<b>13,035</b>	<b>13,975</b>
<b>(Model #6)</b> Wood arm, wood panel							6¾	117	10,830	11,360	11,590	15,200	16,350	16,820	11,465	12,050	12,675	13,330

## FOUR SEAT SOFA



<b>1124_</b>	16½	24¼	128	90	48	29												
<b>(Model #1)</b> Closed upholstered arm							11¾	196	<b>13,940</b>	<b>14,625</b>	<b>15,260</b>	<b>21,270</b>	<b>23,190</b>	<b>23,970</b>	<b>15,055</b>	<b>16,075</b>	<b>17,170</b>	<b>18,305</b>
<b>(Model #4)</b> Open wood arm							8¾	159	12,945	13,590	13,930	18,910	20,460	21,090	13,770	14,530	15,355	16,195
<b>(Model #5)</b> Wood arm, upholstered panel							11¾	184	<b>13,510</b>	<b>14,165</b>	<b>14,825</b>	<b>20,385</b>	<b>22,210</b>	<b>22,930</b>	<b>14,625</b>	<b>15,640</b>	<b>16,740</b>	<b>17,880</b>
<b>(Model #6)</b> Wood arm, wood panel							8¾	156	13,965	14,665	14,975	19,805	21,365	21,980	14,800	15,565	16,375	17,220

## RADIUS OTTOMAN



<b>11200</b>	16½			29	32	16½	2¾	40	2,115	2,205	2,410	3,610	4,005	4,155	2,370	2,605	2,870	3,130
--------------	-----	--	--	----	----	-----	----	----	-------	-------	-------	-------	-------	-------	-------	-------	-------	-------

Max series passes CAL 133 certified for an upcharge of \$435 list per chair, \$870 list per two seater sofa, \$1370 list per three seat sofa, \$1650 list per four seat sofa, and \$380 list per ottoman. Certification applies to Nienkämper leathers and fabrics that have a minimum of 50% natural fibre content. COM's and COL's are subject to approval. Add the extension -CAL to the model number when ordering.

**Model # 11236**  
Three seat sofa with wood arm, wood panel

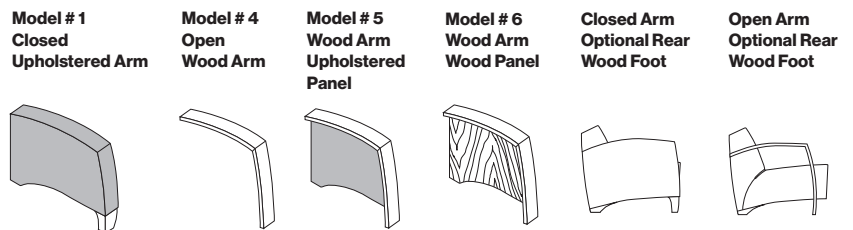

# LOUNGE SEATING

Max™ Concave Designer – mark müller

— US Only —

Model Number	Seat H"	Arm H"	Front W"	Rear W"	D"	H"	Fabric Yds.	Leather Sq.Ft.	COM	COL	Neather	Verde	Grano	Cremoso	Knoll Textiles			
															1	2	3	4
<b>TWO SEAT SOFA</b>																		
	<b>1132_</b>	16½	24¼	41¼	69½	37	29											
	<b>(Model #1)</b>	Closed upholstered arm					8¼	124	<b>8,015</b>	<b>8,415</b>	<b>8,945</b>	<b>12,645</b>	<b>13,885</b>	<b>14,360</b>	<b>8,790</b>	<b>9,515</b>	<b>10,285</b>	<b>11,080</b>
	<b>(Model #4)</b>	Open wood arm					5¼	87	7,015	7,370	7,605	10,285	11,130	11,490	7,515	7,970	8,460	8,970
	<b>(Model #5)</b>	Wood arm, upholstered panel					8¼	107	<b>7,560</b>	<b>7,955</b>	<b>8,485</b>	<b>11,575</b>	<b>12,625</b>	<b>13,050</b>	<b>8,345</b>	<b>9,065</b>	<b>9,835</b>	<b>10,635</b>
	<b>(Model #6)</b>	Wood arm, wood panel					5¼	84	8,040	8,455	8,640	11,185	12,020	12,345	8,545	8,995	9,495	9,995

## THREE SEAT SOFA

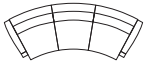

<b>1133_</b>	16½	24¼	72½	101½	43	29											
<b>(Model #1)</b>	Closed upholstered arm					10¾	166	<b>10,755</b>	<b>11,295</b>	<b>11,970</b>	<b>16,960</b>	<b>18,610</b>	<b>19,255</b>	<b>11,775</b>	<b>12,715</b>	<b>13,715</b>	<b>14,750</b>
<b>(Model #4)</b>	Open wood arm					7¾	129	9,790	10,280	10,660	14,620	15,895	16,395	10,525	11,200	11,925	12,665
<b>(Model #5)</b>	Wood arm, upholstered panel					10¾	149	<b>10,350</b>	<b>10,865</b>	<b>11,545</b>	<b>15,920</b>	<b>17,385</b>	<b>17,970</b>	<b>11,375</b>	<b>12,305</b>	<b>13,310</b>	<b>14,350</b>
<b>(Model #6)</b>	Wood arm, wood panel					7¾	126	10,830	11,360	11,690	15,520	16,780	17,290	11,560	12,230	12,960	13,705

## FOUR SEAT SOFA

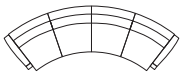

<b>1134_</b>	16½	24¼	78½	123¾	48	29											
<b>(Model #1)</b>	Closed upholstered arm					12¾	208	<b>13,940</b>	<b>14,625</b>	<b>15,360</b>	<b>21,705</b>	<b>23,765</b>	<b>24,580</b>	<b>15,145</b>	<b>16,255</b>	<b>17,455</b>	<b>18,675</b>
<b>(Model #4)</b>	Open wood arm					10¾	171	12,945	13,590	14,155	19,350	21,025	21,695	13,955	14,895	15,900	16,940
<b>(Model #5)</b>	Wood arm, upholstered panel					12¾	191	<b>13,510</b>	<b>14,165</b>	<b>14,930</b>	<b>20,650</b>	<b>22,520</b>	<b>23,265</b>	<b>14,715</b>	<b>15,825</b>	<b>17,020</b>	<b>18,245</b>
<b>(Model #6)</b>	Wood arm, wood panel					10¾	168	13,965	14,665	15,185	20,250	21,910	22,570	14,985	15,925	16,930	17,965

## RADIUS OTTOMAN



<b>11200</b>	16½		29	32	16½	2¾	40	2,115	2,205	2,410	3,610	4,005	4,155	2,370	2,605	2,870	3,130
--------------	-----	--	----	----	-----	----	----	-------	-------	-------	-------	-------	-------	-------	-------	-------	-------

Max series passes CAL 133 certified for an upcharge of \$870 list per two seater sofa, \$1305 list per three seat sofa, \$1735 list per four seat sofa, and \$380 list per ottoman. Certification applies to Nienkämper leathers and fabrics that have a minimum of 50% natural fibre content. COM's and COL's are subject to approval. Add the extension -CAL to the model number when ordering.

### Convex and Concave Elements with wood arm and wood panel



**Model # 1**  
Closed Upholstered Arm

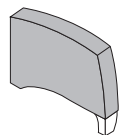

**Model # 4**  
Open Wood Arm



**Model # 5**  
Wood Arm Upholstered Panel

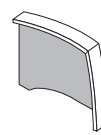

**Model # 6**  
Wood Arm Wood Panel

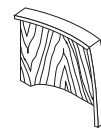

**Closed Arm**  
Optional Rear Wood Foot



**Open Arm**  
Optional Rear Wood Foot



# LOUNGE SEATING

Max™ Elements Designer – mark müller

— US Only —

Model Number	Seat H"	W"	D"	H"	Fabric Yds.	Leather Sq.Ft.	COM	COL	Neather	Verde	Grano	Cremoso	Knoll Textiles						
													1	2	3	4			
<b>STRAIGHT ELEMENT OR ARMLESS END</b>																			
	1115_	16½	23	33	29														
(Model #0) Armless center						2	38	<b>2,205</b>	<b>2,330</b>	<b>2,445</b>	<b>3,625</b>	<b>4,010</b>	<b>4,160</b>	<b>2,400</b>	<b>2,575</b>	<b>2,760</b>	<b>2,955</b>		
(Model #1) One upholstered arm						3½	58	3,400	3,580	3,805	5,575	6,140	6,370	3,735	4,040	4,370	4,700		
(Model #4) One open arm						2	41	<b>3,040</b>	<b>3,175</b>	<b>3,255</b>	<b>4,575</b>	<b>4,975</b>	<b>5,130</b>	<b>3,235</b>	<b>3,400</b>	<b>3,590</b>	<b>3,780</b>		
(Model #5) One wood arm, upholstered panel						3½	50	3,235	3,380	3,615	5,095	5,580	5,785	3,565	3,870	4,200	4,535		
(Model #6) One wood arm, wood panel						2	38	<b>3,450</b>	<b>3,615</b>	<b>3,675</b>	<b>4,870</b>	<b>5,245</b>	<b>5,395</b>	<b>3,640</b>	<b>3,815</b>	<b>4,005</b>	<b>4,190</b>		
(Model #7) Armless end with foot						2	41	2,600	2,730	2,830	4,140	4,540	4,710	2,795	2,965	3,150	3,345		

## CONVEX ELEMENT OR ARMLESS END

	1125_	16½	31½	33	29														
(Model #0) Armless center						2	39	<b>2,815</b>	<b>2,955</b>	<b>3,045</b>	<b>4,270</b>	<b>4,660</b>	<b>4,805</b>	<b>3,010</b>	<b>3,180</b>	<b>3,370</b>	<b>3,560</b>		
(Model #1) One upholstered arm						3½	59	4,010	4,215	4,395	6,225	6,790	7,025	4,340	4,645	4,975	5,305		
(Model #4) One open arm						2	42	<b>3,525</b>	<b>3,700</b>	<b>3,765</b>	<b>5,100</b>	<b>5,525</b>	<b>5,685</b>	<b>3,720</b>	<b>3,895</b>	<b>4,075</b>	<b>4,270</b>		
(Model #5) One wood arm, upholstered panel						3½	51	3,805	4,005	4,185	5,715	6,215	6,420	4,135	4,440	4,770	5,100		
(Model #6) One wood arm, wood panel						2	39	<b>4,045</b>	<b>4,245</b>	<b>4,265</b>	<b>5,490</b>	<b>5,895</b>	<b>6,030</b>	<b>4,240</b>	<b>4,405</b>	<b>4,595</b>	<b>4,790</b>		
(Model #7) Armless end with foot						2	42	3,210	3,375	3,445	4,785	5,195	5,365	3,400	3,570	3,760	3,950		

## CONCAVE ELEMENT OR ARMLESS END

	1135_	16½	31½	33	29														
(Model #0) Armless center						2¾	42	<b>2,815</b>	<b>2,955</b>	<b>3,125</b>	<b>4,380</b>	<b>4,800</b>	<b>4,965</b>	<b>3,080</b>	<b>3,320</b>	<b>3,580</b>	<b>3,840</b>		
(Model #1) One upholstered arm						4¼	62	4,010	4,215	4,480	6,330	6,940	7,185	4,405	4,780	5,175	5,585		
(Model #4) One open arm						2¾	45	<b>3,525</b>	<b>3,700</b>	<b>3,825</b>	<b>5,205</b>	<b>5,655</b>	<b>5,825</b>	<b>3,790</b>	<b>4,030</b>	<b>4,285</b>	<b>4,550</b>		
(Model #5) One wood arm, upholstered panel						4¼	54	3,805	4,005	4,270	5,825	6,365	6,565	4,210	4,575	4,975	5,380		
(Model #6) One wood arm, wood panel						2¾	42	<b>4,045</b>	<b>4,245</b>	<b>4,345</b>	<b>5,605</b>	<b>6,015</b>	<b>6,185</b>	<b>4,300</b>	<b>4,545</b>	<b>4,805</b>	<b>5,065</b>		
(Model #7) Armless end with foot						2¾	45	3,210	3,375	3,510	4,895	5,335	5,525	3,475	3,710	3,965	4,235		

Max series passes CAL 133 certified for an upcharge of \$435 list per element. Certification applies to Nienkämper leathers and fabrics that have a minimum of 50% natural fibre content. COM's and COL's are subject to approval. Add the extension -CAL to the model number when ordering.

Arm width and height dimensions are based on Model # 1, the fully upholstered closed arm option. Wood arms, Model # 4, # 5, and # 6 are available in standard Nienkämper veneers and stains, refer to page 12 for a listing. To match custom stains add \$600 list per chair, for each stain colour.

Creative or traditional shaped sectional sofas are possible by combining a variety of Max Elements.

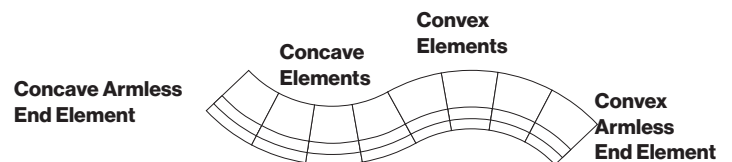

# LOUNGE SEATING

Max™ Elements Designer – mark müller

— US Only —

Model Number	Seat H"	W"	D"	H"	Fabric Yds.	Leather Sq.Ft.	COM	COL	Neather	Verde	Grano	Cremoso	KnollTextiles			
													1	2	3	4

## SQUARE CORNER



<b>11160</b>	16 ½	33	33	29	4 ¼	55	4,060	4,265	4,540	6,125	6,680	6,900	4,465	4,830	5,230	5,640
--------------	------	----	----	----	-----	----	-------	-------	-------	-------	-------	-------	-------	-------	-------	-------

## RADIUS CORNER

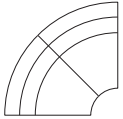

<b>11170</b>	16 ½	42	42	29	4 ½	64	4,535	4,765	5,050	6,925	7,555	7,805	4,960	5,350	5,770	6,210
--------------	------	----	----	----	-----	----	-------	-------	-------	-------	-------	-------	-------	-------	-------	-------

Max series passes CAL 133 certified for an upcharge \$435 list per element. Certification applies to Nienkämper leathers and fabrics that have a minimum of 50% natural fibre content. COM's and COL's are subject to approval. Add the extension -CAL to the model number when ordering.

Creative or traditional shaped sectional sofas are possible by combining a variety of Max Elements.

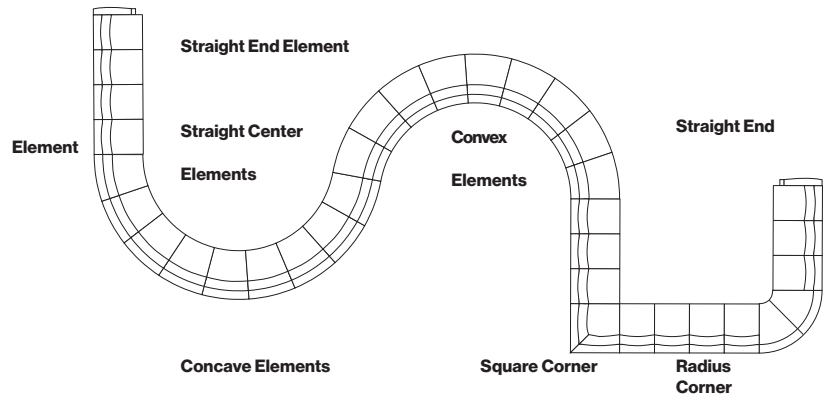



with wood arm and wood panel



# LOUNGE SEATING

Max Tuxedo™ Designer – mark müller

— US Only —

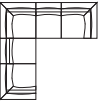
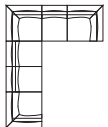
Model Number	Seat H"	Arm H"	W"	D"	H"	Fabric Yds.	Leather Sq.Ft.	COM	COL	Neather	Verde	Grano	Cremoso	Knoll Textiles				
														1	2	3	4	
<b>TWO SEAT SOFA</b>																		
	<b>11020</b>	16½	29	66	33	29	10	110	9,355	9,825	10,470	13,465	14,550	14,985	10,300	11,170	12,100	13,065
<b>THREE SEAT SOFA</b>																		
	<b>11030</b>	16½	29	89	33	29	12	148	11,515	12,100	12,870	17,055	18,515	19,100	12,650	13,700	14,820	15,975
<b>FOUR SEAT SOFA</b>																		
	<b>11040</b>	16½	29	112	33	29	14	184	13,695	14,365	15,260	20,570	22,385	23,115	15,015	16,235	17,545	18,890
<b>FIVE SEAT L-SHAPED SOFA</b>																		
	<b>11070</b>	16½	29	89	89	29	16¾	229	16,415	17,240	18,300	24,985	27,235	28,135	18,005	19,460	21,025	22,640
<b>SIX SEAT L-SHAPED SOFA</b>																		
	<b>11080</b>	16½	29	89	112	29	18¾	261	18,585	19,525	20,695	28,365	30,920	31,955	20,355	21,995	23,745	25,550







**Model # 11030**  
Three seat sofa

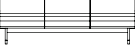

# LOUNGE SEATING

Mood Collection Designer – Charles Godbout

— US Only —

Model Number	Seat H"	Arm H"	W"	D"	H"	Fabric Yds.	Leather Sq. Ft.	COM	COL	Verde	Grano	Cremoso	Knoll Textiles				
													1	2	3	4	
<b>LOUNGE CHAIR, ARMLESS</b>																	
 <b>11481</b>	15½		29½	31	29½	2½	34	5,985	6,280	6,910	7,205	7,325	6,225	6,440	6,675	6,915	
<b>TWO SEAT SOFA, ARMLESS</b>																	
 <b>11482</b>	15½		59¼	31	29½	5	58	7,930	8,320	9,510	10,020	10,205	8,410	8,845	9,310	9,790	
<b>THREE SEAT SOFA, ARMLESS</b>																	
 <b>11483</b>	15½		89	31	29½	7½	83	8,575	9,005	10,840	11,590	11,840	9,290	9,940	10,640	11,360	
<b>LOUNGE CHAIR WITH ARMS</b>																	
 <b>11485</b>	15½	22¼	40	31	29¾	2½	41	6,905	7,220	8,015	8,380	8,505	7,140	7,360	7,595	7,840	
<b>TWO SEAT SOFA WITH ARMS</b>																	
 <b>11486</b>	15½	22¼	69¾	31	29¾	5	65	8,840	9,275	10,615	11,195	11,390	9,310	9,745	10,210	10,690	
<b>THREE SEAT SOFA WITH ARMS</b>																	
 <b>11487</b>	15½	22¼	99½	31	29¾	7½	90	9,500	9,975	11,945	12,760	13,030	10,205	10,860	11,560	12,280	

**Model # 11481**  
Mood Lounge Chair, Armless



**Model # 11485**  
Mood Lounge Chair with Arms



## Standard Features

- Brushed Nickel frame
- FSC certified hardwood plywood frame
- Foam cushions with 25 percent soya content

# LOUNGE SEATING

Nordic Designer - Nienkämper

— US Only —

Model Number	Seat H"	W"	D"	H"	Fabric		COM	COL	Neather	Verde	Grano	Cremoso	Knoll Textiles			
					Yds.	Sq.Ft.							1	2	3	4

## NORDIC



<b>10262</b>	16½	28	26	29½	2	36	3,080	3,235	3,270	4,165	4,350	4,450	3,275	3,445	3,630	3,825
--------------	-----	----	----	-----	---	----	-------	-------	-------	-------	-------	-------	-------	-------	-------	-------

Model # 10262



### Standard features:

- Moulded plywood frame
- Seat and back cushions with polyurethane foam
- Base is beech plywood available in natural finish and standard nienkämper paint finish
- Custom stained to match on the base is also available with upcharge



# LOUNGE SEATING

Note Designer - busk + hertzog

— US Only —

Model Number	Seat H"	Arm H"	W"	D"	H"	Fabric Yds.	Leather Sq.Ft.	COM	COL	Neather	Verde	Grano	Cremoso	Knoll Textiles			
														1	2	3	4

## NOTE CHAIR ON GLIDES

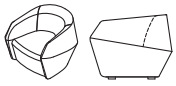

**10651** 16 25¼ 33 34½ 27¾ 5½ 99

3,735 3,925 4,240 6,440 6,875 7,310 3,980 4,200 4,430 4,670

## NOTE CHAIR WITH SWIVEL DISK

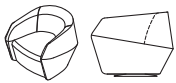

**10654** 16 25¼ 33 34½ 27¾ 6½ 113

4,040 4,245 4,630 7,110 7,610 8,110 4,330 4,585 4,850 5,135

## NOTE TWO SEAT SOFA

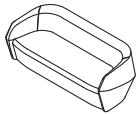

**10652** 16 25¼ 69 34½ 27¾ 8½ 153

5,070 5,325 5,840 9,205 9,885 10,555 5,445 5,790 6,135 6,505

## NOTE THREE SEAT SOFA

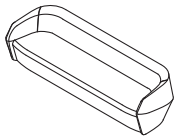

**10653** 16 25¼ 93 34½ 27¾ 9½ 171

6,345 6,665 7,205 11,000 11,755 12,515 6,765 7,140 7,530 7,950

### Standard Features:

- Frame is constructed of solid maple & FSC hardwood plywood with soy based polyurethane foam.
- Note chair is available on glides or with swivel disk in upholstery finish.
- Contrasting stitching can be specified on outside back with no upcharge.

Optional contrast stitching on outside back:

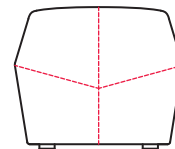

Back Elevation

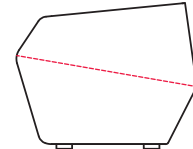

Side Elevation

**Model # 10651**  
Note chair



**Model # 10652**  
Note two seat sofa



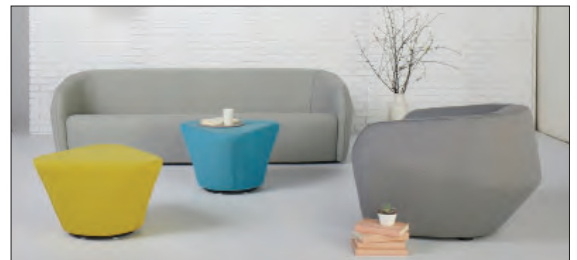

**Model # 10651 & 10653**  
Note chair & three seat sofa with Mint Stools



# LOUNGE SEATING

Paris Archive Designer – Nienkämper

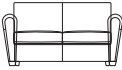
— US Only —

Model Number	Seat		Arm H"	W"	D"	H"	Fabric Yds.	Leather Sq. Ft.	COM	COL	Verde	Grano	Cremoso	Knoll Textiles			
	H"	H"												1	2	3	4
<b>CLUB CHAIR</b>																	
	<b>250</b>	17	22½	34	37	31	8	105	7,690	8,070	11,625	12,650	13,080	8,445	9,145	9,895	10,665
<b>SMALL TWO SEAT SOFA</b>																	
	<b>250-2</b>	17	22½	57	37	31	11	144	8,685	9,130	14,080	15,490	16,060	9,730	10,685	11,715	12,775
<b>LARGE TWO SEAT SOFA</b>																	
	<b>250-2L</b>	17	22½	73	37	31	13	170	9,265	9,730	15,635	17,305	17,970	10,495	11,630	12,845	14,100
<b>OTTOMAN</b>																	
	<b>250-5</b>			32	32	17	4	52	2,295	2,400	4,245	4,755	4,960	2,680	3,020	3,395	3,780

Feet are 2" high. Feet can be ordered in wood and are available in standard Nienkämper veneers and stains, refer to page 12 for a listing. Custom stains are available, add \$600 list for each custom stain required.

The price of contrasting leather is included in the COM and COL prices. The following leather square footages should be added for the welting:

Paris Archive Club Model # 250 – 6 Sq. Ft.

Small Two Seat Sofa Model # 250-2 – 9 Sq. Ft.

Large Two Seat Sofa Model # 250-2L – 11 Sq. Ft.

Ottoman Model # 250-5 – 3 Sq. Ft.

**Model #250**



**Model #250-5**



# LOUNGE SEATING

Patkau Twist Designer – Patkau Architects

---

Model Number	Seat H"	W"	D"	H"	List Price
--------------	---------	----	----	----	------------

---

## PATKAU TWIST

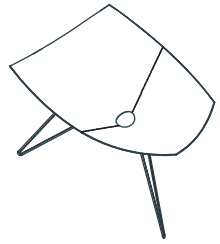

10286

16

51

30¾

30½

(Seat Dimensions:  
51" x 23½" x 16")

---

3,940

---

### Standard Features

- Seat Material: plywood
- Frame Material: stainless steel rod
- Seat Finish: standard stain & finish
- Frame Finish: brushed stainless, powder coat satin black

Model # 10286  
Patkau Twist



# LOUNGE SEATING

Polo Designer – Nienkamper

— US Only —

Model Number	Seat H"	W"	D"	H"	Fabric Yds.	Leather Sq.Ft.	COM	COL	Verde	Grano	Cremoso	Knoll Textiles			
												1	2	3	4

## POLO CHAIR

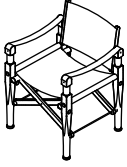

<b>13917</b>	17¼	22½	21	33	2	36	2,970	3,125	4,110	4,235	4,350	3,065	3,140	3,220	3,310
--------------	-----	-----	----	----	---	----	-------	-------	-------	-------	-------	-------	-------	-------	-------

**Model # 13917**  
Polo Chair





### Standard Features

- Solid wood legs

# LOUNGE SEATING

Pullman™ Designer – Nienkämper

— US Only —

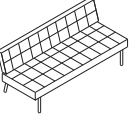
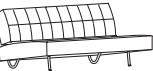
Model Number	Seat H"	W"	D"	H"	Fabric Yds.	Leather Sq. Ft.	COM	COL	Verde	Grano	Cremoso	Knoll Textiles						
												1	2	3	4			
<b>LOUNGE CHAIR</b>																		
	<b>15704</b>	16	28	30	30													
	Fully upholstered - Tufted					2¼	32	3,550	3,720	4,965	5,335	5,490	3,765	3,955	4,165	4,390		
Fully upholstered - Plain						2¼		3,550				3,765	3,955	4,165	4,390			
<b>TWO SEAT SOFA</b>																		
	<b>15706</b>	16	49	30	30													
	Fully upholstered - Tufted					3	54	5,375	5,650	7,165	7,640	7,840	5,655	5,920	6,205	6,490		
Fully upholstered - Plain						3		5,375				5,655	5,920	6,205	6,490			
<b>THREE SEAT SOFA</b>																		
	<b>15707</b>	16	70	30	30													
	Fully upholstered - Tufted					4½	76	7,340	7,710	10,060	10,755	11,025	7,770	8,160	8,580	9,015		
Fully upholstered - Plain						4½		7,340				7,770	8,160	8,580	9,015			
<b>SLEEPER SOFA</b>																		
	<b>15701</b>	16	80	42	30½													
	Fully upholstered - Tufted					7	112	8,025	8,430	12,210	13,320	13,745	8,685	9,300	9,950	10,630		
Fully upholstered - Plain						7		8,025				8,685	9,300	9,950	10,630			

### Pullman Chair

Fabric yardages are based on a 54" width with no repeat, see page 6 for instructions. The base is available in a brushed nickel finish as standard; add 5% for a polished chrome finish.

### Pullman Sleeper Sofa





Fabric yardages are based on a 54" width with no repeat, fabric must be railroaded, see page 6 for instructions. The base is available in a brushed nickel finish as standard; add 5% for a polished chrome finish. Measurements of the Sleeper Sofa used as a bed are: width 80" x depth 50" x height 16".



# LOUNGE SEATING

Pullman™ Designer – Nienkämper

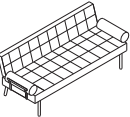
— US Only —

	Model Number	Seat H"	Arm H"	W"	D"	H"	Fabric Yds	Leather Sq.Ft.	COM	COL	Verde	Grano	Cremoso	Knoll Textiles			
														1	2	3	4
<b>LOUNGE CHAIR WITH ARMS</b>																	
	<b>15714</b>	17	24½	35	30	30											
	Fully upholstered - tufted						3¼	48	5,315	5,575	7,330	7,855	8,070	5,615	5,905	6,210	6,525
	Fully upholstered - plain						3¼	5,315					5,615	5,905	6,210	6,525	
<b>TWO SEAT SOFA WITH ARMS</b>																	
	<b>15715</b>	16	24½	56	30	30											
	Fully upholstered - tufted						4	70	7,135	7,515	9,540	10,170	10,415	7,520	7,865	8,240	8,630
	Fully upholstered - plain						4	7,135					7,520	7,865	8,240	8,630	
<b>THREE SEAT SOFA WITH ARMS</b>																	
	<b>15716</b>	16	24½	77	30	30											
	Fully upholstered - tufted						5½	92	9,125	9,555	12,405	13,280	13,620	9,645	10,125	10,645	11,170
	Fully upholstered - plain						5½	9,125					9,645	10,125	10,645	11,170	
<b>SLEEPER SOFA WITH ARMS</b>																	
	<b>15717</b>	16	22	87	42	30½											
	Fully upholstered - tufted						8	128	9,785	10,280	14,025	15,830	16,340	10,540	11,235	11,990	12,760
	Fully upholstered - plain						8	9,785					10,540	11,235	11,990	12,760	

### Pullman Chair

Fabric yardages are based on a 54" width with no repeat, see page 6 for instructions. The base is available in a brushed nickel finish as standard; add 5% for a polished chrome finish.

### Pullman Sleeper Sofa

Fabric yardages are based on a 54" width with no repeat, fabric must be railroaded, see page 6 for instructions. The base is available in a brushed nickel finish as standard; add 5% for a polished chrome finish. Measurements of the Sleeper Sofa used as a bed are: width 87" x depth 50" x height 16".



# LOUNGE SEATING

Pyramid Chair Designer—Karim Rashid

— US Only —

Model Number	W"	D"	H"	Fabric Yds.	Leather Sq. Ft.	COM	COL	Verde	Grano	Cremoso	Knoll Textiles			
											1	2	3	4

## PYRAMID CHAIR

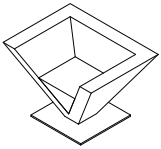

### 10510

Fully	38	29	26	7	126	2,540	2,675	5,955	7,115	7,500	3,200	3,815	4,465	5,140
Body				6	108									
Seat				1	18									

### Frame:

FSC plywood.

### Seat and Back:

Soy based foam and fortrel.

### Base:

Brushed stainless steel base.

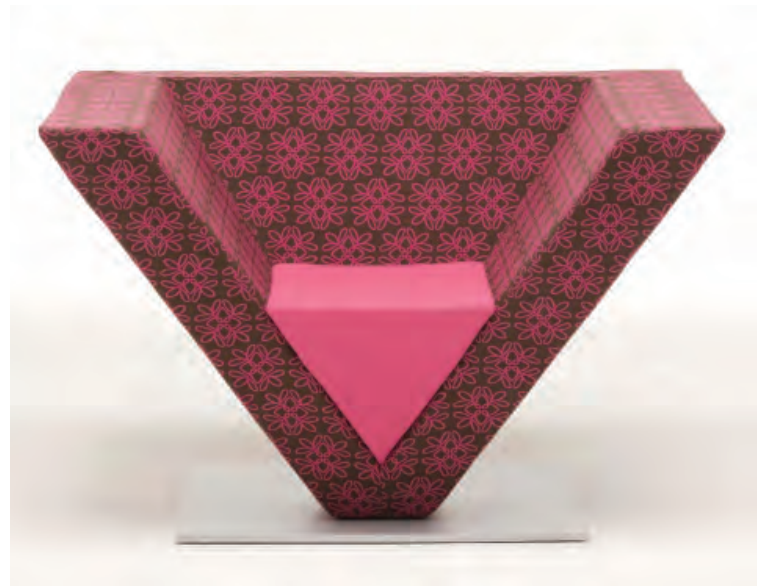

# LOUNGE SEATING

Q Chair Designer - Q Design

— US Only —

Model Number	Seat H"	Arm H"	W"	D"	H"	Fabric		COM	COL	Neather	Verde	Grano	Cremoso	Knoll Textiles			
						Yds.	Sq.Ft.							1	2	3	4

## Q LOUNGE CHAIR WITH VENEER



10051	16½	21¼	31½	31	34½	2¾	49	4,115	4,320	4,315	5,295	5,490	5,590	4,370	4,600	4,845	5,100
-------	-----	-----	-----	----	-----	----	----	-------	-------	-------	-------	-------	-------	-------	-------	-------	-------

## Q LOUNGE CHAIR - FULLY UPHOLSTERED



10053	16½	21¼	31½	31	34½	4	72	3,905	4,105	4,090	5,035	5,215	5,320	4,280	4,630	5,005	5,390
-------	-----	-----	-----	----	-----	---	----	-------	-------	-------	-------	-------	-------	-------	-------	-------	-------

## Q SIDE CHAIR WITH VENEER



10052	18	24	27½	23	34	1½	27	3,545	3,710	3,690	4,450	4,595	4,670	3,690	3,820	3,955	4,110
-------	----	----	-----	----	----	----	----	-------	-------	-------	-------	-------	-------	-------	-------	-------	-------

## Q SIDE CHAIR - FULLY UPHOLSTERED



10054	18	24	27½	23	34	3	54	3,360	3,525	3,500	4,230	4,370	4,445	3,650	3,910	4,190	4,480
-------	----	----	-----	----	----	---	----	-------	-------	-------	-------	-------	-------	-------	-------	-------	-------

Model # 10051



Model # 10052



### Standard features:

- Moulded plywood seat & arm shell
- Soy based flexible polyurethane foam
- Maple or walnut veneer with any Nienkämper stains is available for model with veneer finish (Model #10051 & #10052)
- Q Side Chair with veneer back has only seat & arm shell but a fully upholstered back
- Polished aluminum 4-star base on glides for Q Lounge chair
- Polished aluminum cross base for Q Side chair



# LOUNGE SEATING

Radius Designer - Christopher Panichella

— US Only —

Model Number	Seat Arm			D"	H"	Fabric Yds.	Leather Sq.Ft.	COM	COL	Neather	Verde	Grano	Cremoso	Knoll Textiles			
	H"	H"	W"											1	2	3	4

## RADIUS LOW BACK - WITH WOOD BACK



10770	16	27	33¼	33	29	3½	63	5,815	6,045	5,905	7,790	8,120	8,285	6,150	6,455	6,780	7,115
-------	----	----	-----	----	----	----	----	-------	-------	-------	-------	-------	-------	-------	-------	-------	-------

## RADIUS LOW BACK - FULLY UPHOLSTERED



10771	16	27	33¼	33	29	4½	81	4,565	4,795	5,010	7,025	7,455	7,680	4,990	5,380	5,800	6,235
-------	----	----	-----	----	----	----	----	-------	-------	-------	-------	-------	-------	-------	-------	-------	-------

## RADIUS HIGH BACK

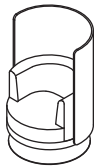

10772	16	27	33¼	33	48	6¾	122	7,190	7,555	7,865	10,940	11,575	11,895	7,830	8,420	9,045	9,700
-------	----	----	-----	----	----	----	-----	-------	-------	-------	--------	--------	--------	-------	-------	-------	-------

## ACCESSORIES

### TABLET ARM



12461				20	12	½		1,505									
-------	--	--	--	----	----	---	--	-------	--	--	--	--	--	--	--	--	--

### CUP HOLDER



10774							4 dia	610									
-------	--	--	--	--	--	--	-------	-----	--	--	--	--	--	--	--	--	--

## POWER

### Simple Dot Forums



White receptacle, model #11867/W \$???	White stacked USB, model #11868/W \$???	Black receptacle, model #11967/B \$???	Black stacked USB, model #11868/B \$???
--	---	--	---

### Vox Simple Dot Forums with Trim



Satin nickel trim with white receptacle, model #11864NW \$285 List	Satin nickel trim with white stacked USB, model #11865NW \$490 list	Satin nickel trim with black receptacle, model #11864NB \$285 list	Satin nickel trim with black stacked USB, model #11865NB \$490 list
--	---	--	---

### Standard Features:

- Seat depth: 22"d
- Seat and back cushions have a foam core with Dacron wrap.
- Legs standard in mirror polish.
- Radius Low Back chair is available with wood back on exterior. Select from standard Nienkämper veneer & stains.
- Radius High Back chair is only available fully upholstered.

### Optional Features:

- Tablet top available in ½" thick solid Fingerprint Resistance P-lam in pure White or Black.
- Tablet arm support in silver or white powder coat finish
- Cup holder available in polished or brushed aluminum.
- Cup holder top with leather or vinyl inset in white or black as standard.
- Power Outlet or stacked USB Charger with 72" cord in satin nickel standard

Model # 10770  
Radius low back  
with wood back



Radius low back  
upholstered in Ecopell  
leather Blackberry EC100

Model # 10772  
Radius high back with tablet,  
cup holder & power



Tablet arm available in white or  
silver finish

# LOUNGE SEATING

Radius on Legs Designer - Christopher Panichella

— US Only —

Model Number	Seat Arm		W"	D"	H"	Fabric Yds.	Leather Sq. Ft.	COM	COL	Neather	Verde	Grano	Cremoso	Knoll Textiles			
	H"	H"												1	2	3	4

## RADIUS LOW BACK - WITH WOOD BACK

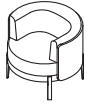

10775	16	28¼	33½	32¾	28¼	3½	63	5,695	5,920	5,765	7,660	7,990	8,160	6,025	6,330	6,660	6,990
-------	----	-----	-----	-----	-----	----	----	-------	-------	-------	-------	-------	-------	-------	-------	-------	-------

## RADIUS LOW BACK - FULLY UPHOLSTERED



10776	16	28¼	33½	32¾	28¼	4½	81	4,440	4,665	4,880	6,910	7,330	7,545	4,865	5,250	5,670	6,115
-------	----	-----	-----	-----	-----	----	----	-------	-------	-------	-------	-------	-------	-------	-------	-------	-------

## RADIUS HIGH BACK

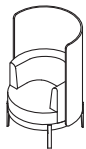

10777	16	28¼	33½	32¾	47½	6¾	122	7,080	7,430	7,740	10,805	11,440	11,775	7,715	8,305	8,935	9,585
-------	----	-----	-----	-----	-----	----	-----	-------	-------	-------	--------	--------	--------	-------	-------	-------	-------

## ACCESSORIES

### TABLET ARM



12461			20	12	½			1,505									
-------	--	--	----	----	---	--	--	-------	--	--	--	--	--	--	--	--	--

### CUP HOLDER



10774			4 dia					610									
-------	--	--	-------	--	--	--	--	-----	--	--	--	--	--	--	--	--	--

## POWER

### Simple Dot Forums



White receptacle, model #11867/W \$??? List



White stacked USB, model #11868/W \$??? list



Black receptacle, model #11967/B \$??? List



Black stacked USB, model #11868/B \$??? list

### Simple Dot Forums with Trim



Satin nickel trim with white receptacle, model #11864NW \$285 List



Satin nickel trim with white stacked USB, model #11865NW \$490 list



Satin nickel trim with black receptacle, model #11864NB \$285 list



Satin nickel trim with black stacked USB, model #11865NB \$490 list

Model # 10777  
Radius on legs



Tablet arm available in white or silver finish



### Standard Features:

- Seat depth: 22"d
- Seat and back cushions have a foam core with Dacron wrap.
- Legs standard in mirror polish.
- Radius Low Back chair is available with wood back on exterior. Select from standard Nienkämper veneer & stains.
- Radius High Back chair is only available fully upholstered.

### Optional Features:

- Tablet top available in ½" thick solid Fingerprint Resistance P-lam in pure White or Black.
- Tablet arm support in silver or white powder coat finish
- Cup holder available in polished or brushed aluminum.
- Cup holder top with leather or vinyl inset in white or black as standard.
- Power Outlet or stacked USB Charger with 72" cord in satin nickel standard

# LOUNGE SEATING

Rowan Lounge Collection Designer - Yabu Pushelburg

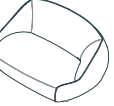
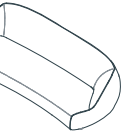
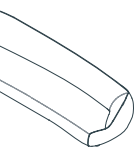
Model Number	Seat		D"	H"	Fabric Yds.	Leather Sq. Ft.	— US Only —										
	H"	W"					COM								Knoll Textiles		
							COL	Neather	Verde	Grano	Cremoso	1	2	3	4		
<b>ROWAN LOUNGE CHAIR</b>																	
	<b>10660</b> on glides	16	34%	36	27%	5.5	99	4,115	4,325	4,610	6,835	7,560	10,220	4,355	4,575	4,800	5,040
	<b>10661</b> swivel base	16	34%	36	27%	5.5	99	4,275	4,490	4,780	7,005	7,730	10,390	4,515	4,740	4,965	5,210
<b>ROWAN LARGE LOUNGE CHAIR</b>																	
	<b>10662</b>	16	52%	36	27%	6.5	117	4,725	4,965	5,320	7,935	8,450	8,970	4,975	5,195	5,420	5,660
<b>ROWAN 2-SEATER SOFA</b>																	
	<b>10663</b>	16	82%	36	27%	7	126	5,580	5,860	6,215	9,060	9,615	10,170	5,890	6,165	6,455	6,765
<b>ROWAN 3-SEATER SOFA</b>																	
	<b>10664</b>	16	118%	36	27%	8	144	6,980	7,330	7,705	10,985	11,620	12,255	7,330	7,650	7,975	8,330

**Standard Features:**

- Constructed from soybased polyurethane foam over rigid frame
- Sofa sits on glides
- Chairs available on glide or swivel base

**Model # 10661**  
Rowan Arm Lounge Chair upholstered in Knoll Velvetk 784/74 Moss



**Model # 10664**  
Rowan Lounge 3 Seater Sofa upholstered in Maharam 466420 Huddle Pottery 002



# LOUNGE SEATING

Satori™ & Satori™ with Tablet Arm Designer - Mark saffell & David ritich

Model Number	Seat H"	Arm H"	W"	D"	H"	Fabric Yds.	Leather Sq. Ft.	COM	COL	Neather	Verde	Grano	Cremoso	— US Only — Knoll Textiles			
														1	2	3	4

## SATORI



<b>23201</b>	17½	28½	26½	25	30	3½	52	3,070	3,220	3,465	5,020	5,540	5,745	3,400	3,705	4,035	4,370
--------------	-----	-----	-----	----	----	----	----	-------	-------	-------	-------	-------	-------	-------	-------	-------	-------

## SATORI WITH LOW ARM



<b>23203</b>	17½	24¾	26½	25	30	3½	50	2,975	3,135	3,375	4,945	5,460	5,655	3,310	3,615	3,940	4,275
--------------	-----	-----	-----	----	----	----	----	-------	-------	-------	-------	-------	-------	-------	-------	-------	-------

## SATORI WITH TABLET ARM

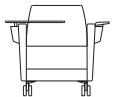

<b>23202</b>	17¼	24¾	30¾	24¼	30½	3½	50	4,605	4,845	5,010	6,565	7,100	7,305	4,945	5,240	5,575	5,910
--------------	-----	-----	-----	-----	-----	----	----	-------	-------	-------	-------	-------	-------	-------	-------	-------	-------

Satori and Satori with Tablet Arm are available as CAL 133 certified for an upcharge of \$4 list per chair. Certification applies to Nienkämper leathers and fabrics that have a minimum of 50% natural fibre content. COM's and COL's are subject to approval. Add the extension -CAL to the model number when ordering.

**Model # 23201**  
Satori



**Model # 23202**  
A mesh pocket for storage and interchangeable cup holder.

**Model # 23202**  
Satori with interchangeable tablet arm accommodates right and left-handed users.



Castors on the Satori chair make it easy to reconfigure meeting space.

### Satori with Tablet Arm





Mesh pocket dimensions are 21" w x 11" h. The tablet arm is made of marine-grade plastic. Legs are cast aluminum.

Specify polished or brushed aluminum finish for tablet holder, cup holder & leg finish.

Handle is in brushed stainless steel finish

# LOUNGE SEATING

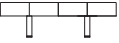
Six Collection Designer – Nienkämper

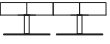
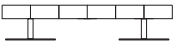



Model Number	Seat H"	Arm H"	W"	D"	H"	Fabric Yds.	Leather Sq.Ft.	COM	COL	Verde	Grano	Cremoso	— US Only — KnollTextiles													
													1	2	3	4										
<b>LOUNGE CHAIR</b>																										
 <b>30301</b>	16	23¾	32	28	30½	3	45								3,175	3,320	3,375	4,300	4,595	4,710	3,460	3,720	4,010	4,290		
<b>LOUNGE CHAIR W TABLET</b>																										
 <b>30302</b>	16	23¾	32	28	30½	3	45								3,745	3,935	3,935	4,870	5,165	5,270	4,035	4,290	4,580	4,870		
<b>2 SEAT BENCH</b>																										
 <b>30303</b>	17		55	31½		3	45								4,250	4,410	4,515	5,920	6,355	6,535	4,535	4,795	5,075	5,370		
<b>3 SEAT BENCH</b>																										
 <b>30304</b>	17		82	31½		4½	81								4,760	4,955	5,165	7,265	7,920	8,185	5,180	5,575	5,995	6,430		
<b>OTTOMAN</b>																										
 <b>30305</b>	17		28	27¾		1½	27								2,835	2,950	2,980	3,685	3,900	3,980	2,980	3,115	3,255	3,400		
<b>30310</b>	17		28	27¾		1½	27								2,125	2,235	2,260	2,960	3,175	3,265	2,260	2,390	2,535	2,685		
<b>2 SEAT BENCH ON PEDESTALS</b>																										
 <b>30308</b>	17		63	31½		3	54								3,525	3,695	3,805	5,200	5,640	5,815	3,815	4,070	4,355	4,650		
<b>3 SEAT BENCH ON PEDESTALS</b>																										
 <b>30309</b>	17		82	31½		4½	81								4,040	4,240	4,450	6,540	7,195	7,455	4,465	4,855	5,275	5,715		
<b>SIX COLLECTION A</b>																										
Cup <b>30306</b>																									90	
Cup holder <b>30307</b>																										95

Six Collection passes CAL 133 certified for an upcharge of \$440 list per chair, \$640 per 2 seat bench, \$830 per 3 seat chair and \$380 per ottoman. Certification applies to Nienkämper leathers and fabrics that have a minimum of 50% natural fibre content. COM's and COL's are subject to approval. Add the extension -CAL to the model number when ordering.

# LOUNGE SEATING

Spirit Designer – Brian Kane

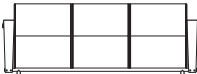
— US Only —

Model Number	Seat H"	Arm H"	W"	D"	H"	Fabric Yds.	Leather Sq.Ft.	COM	COL	Verde	Grano	Cremoso	Knoll Textiles				
													1	2	3	4	
<b>LOUNGE CHAIR</b>																	
 <b>16110</b>	17½	23½	33½	33	30	3	40	6,205	6,505	7,700	8,100	8,255	6,485	6,750	7,030	7,320	
<b>TWO SEAT SOFA</b>																	
 <b>16120</b>	17½	23½	57½	33	30	6	80	9,385	9,865	12,200	12,940	13,220	9,950	10,470	11,040	11,615	
<b>THREE SEAT SOFA</b>																	
 <b>16130</b>	17½	23½	81½	33	30	9	120	12,780	13,415	16,905	17,995	18,430	13,630	14,420	15,260	16,130	
<b>OTTOMAN</b>																	
 <b>16150</b>			24	22	17½	1½	28	3,145	3,295	4,575	4,955	5,095	3,305	3,455	3,610	3,765	

**Spirit series passes CAL 133 certified for an upcharge of \$415 list per chair, \$825 list per two seater sofa, and \$1240 list per three seat sofa and \$360 list per ottoman. Certification applies to Nienkämper leathers and fabrics that have a minimum of 50% natural fibre content. COM's and COL's are subject to approval. Add the extension -CAL to the model number when ordering.**

Model #16110



Model #16110



Model #16120



Model #16150







Select one of the following finishes for the tubular steel frame: Brushed stainless steel, matte black or gloss black. Laminated maple armrests, with black veneer detail, are available in standard Nienkämper veneers and stains, or ebonized, see page 12 for a complete listing. Optional veneers are not offered.

# LOUNGE SEATING

Turnaround® Designer - Nienkämper

— US Only —



Model Number	Seat H"	Arm		D"	H"	Fabric Yds.	Leather Sq.Ft.	COM	COL	Verde	Grano	Cremoso	Knoll Textiles										
		H"	W"										1	2	3	4							
<b>LOUNGE CHAIR WITHOUT ARMS</b>																							
	<b>15401</b>	18¾	25	32	32¼	2½	41								2,415	2,555	3,625	4,040	4,160	2,665	2,880	3,110	3,350
<b>LOUNGE CHAIR WITH ARMS</b>																							
	<b>15402</b>	18¾	25¼	36	32	32¼	3½	50							3,580	3,765	5,050	5,535	5,705	3,915	4,220	4,545	4,880
<b>LOUNGE CHAIR WITH TABLET ARMS</b>																							
	<b>15405</b>	18¾	25¼	36	32	32¼	3	50							5,195	5,445	6,740	7,140	7,320	5,475	5,735	6,020	6,315
<b>OTTOMAN</b>																							
	<b>15403</b>	17½	21½	21½		1¾	30								1,175	1,230	2,110	2,340	2,445	1,325	1,480	1,630	1,795
<b>OPTIONAL OTTOMAN TOP ACCESSORY</b>																							
	<b>15404</b>		22½	22½	1¾		8									790	825						

## Turnaround

- Hardwood/Plywood frame, polyurethane foam and fortrell.
- The back rest on the Armless chair can swivel 360 degrees around the seat with also turns.
- The back swivels independent of the seat and base.
- The Armchair turns (swivels) on its base.
- The round ottoman turns (swivels) and has an optional leather tray that acts as a cocktail table.
- Tablet Arm is made of marine-grade plastic.

# LOUNGE SEATING

Tuxedo™ Designer – Nienkämper

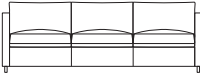
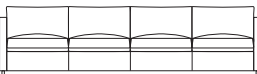
														— US Only —					
Model Number	Seat H"	Arm H"	W"	D"	H"	Fabric Leather		COM	COL	Verde	Grano	Cremoso	Knoll Textiles						
						Yds.	Sq. Ft.						1	2	3	4			
<b>ARMLESS LOUNGE</b>																			
	<b>765</b>	18		25¾	35¾	29	4	65											
<b>LOUNGE</b>																			
	<b>765-1</b>	18	24¾	31¾	35¾	29	7½	92											
<b>TWO SEAT SOFA</b>																			
	<b>765-2</b>	18	24¾	57½	35¾	29	11½	132											
<b>THREE SEAT SOFA</b>																			
	<b>765-3</b>	18	24¾	83¾	35¾	29	16	172											
<b>FOUR SEAT SOFA</b>																			
	<b>765-4</b>	18	24¾	109	35¾	29	20½	212											

**Tuxedo passes CAL 133 certified for an upcharge of \$440 list per chair for armless and arm chair, \$870 list per 2 seat sofa, \$1,305 list per 3 seat sofa and \$1,755 list per 4 seat sofa. Certification applies to Nienkämper leathers and fabrics that have a minimum of 50% natural fibre content. COM's and COL's are subject to approval. Add the extension -CAL to the model number when ordering.**

This Tuxedo sofa is offered without a welting detail. The armless lounge chair has finished sides.

When upholstered in leather or COM, seat and back cushions are a foam core with a Dacron wrap. Seat and back cushions are loose.



The base is a recessed ebonized runner.



# LOUNGE SEATING

Tuxedo™ Designer – Nienkämper

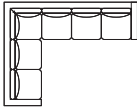
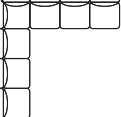
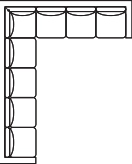
— US Only —

Model Number	Seat H"	Arm H"	W"	D"	H"	Fabric Yds.	Leather Sq. Ft.	COM	COL	Verde	Grano	Cremoso	Knoll Textiles										
													1	2	3	4							
<b>SIX SEAT L-SHAPED SOFA</b>																							
 <b>765-6</b>	18	24¾	116	90¼	29	32	322								21,420	22,495	38,245	42,655	44,410	24,440	27,230	30,210	33,300
<b>SEVEN SEAT L-SHAPED SOFA</b>																							
 <b>765-7</b>	18	24¾	116	116	29	36	362								23,970	25,185	43,105	48,130	50,140	27,365	30,510	33,865	37,340
<b>EIGHT SEAT L-SHAPED SOFA</b>																							
 <b>765-8</b>	18	24¾	116	141¼	29	40	402								27,330	28,695	48,765	54,415	56,670	31,105	34,595	38,320	42,180
<b>OTTOMAN</b>																							
 <b>765-5</b>			25¾	25¾	17¾	2½	42								2,205	2,330	4,270	4,810	5,040	2,450	2,670	2,900	3,140

This Tuxedo sofa is offered without a welting detail.





When upholstered in leather or COM, seat and back cushions are a foam core with a Dacron wrap. Seat and back cushions are loose.

The base is a recessed ebonized runner.

# LOUNGE SEATING

Tuxedo Classic™ Low Arm Designer – Nienkämper

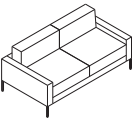
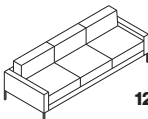
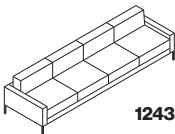
— US Only —

Model Number	Seat Arm		W"	D"	H"	Fabric Yds.	Leather Sq.Ft.	COM	COL	Neather	Verde	Grano	Cremoso	Knoll Textiles			
	H"	H"												1	2	3	4
<b>LOUNGE CHAIR ON LEGS</b>																	
 <b>12431</b>	17	21¾	30½	30½	29¾	4½	72	3,815	4,345	4,005	6,505	7,210	7,515	4,125	4,510	4,935	5,375
<b>LOUNGE CHAIR - SWIVEL BASE</b>																	
 <b>12443</b>	17	21¾	30½	30½	29¾	5½	72	3,660	3,825	4,130	6,225	6,915	7,165	4,180	4,660	5,175	5,705
<b>TWO SEAT SOFA</b>																	
 <b>12432</b>	17	21¾	55	30½	29¾	6	96	5,560	5,825	6,225	9,150	10,095	10,470	6,130	6,655	7,215	7,795
<b>THREE SEAT SOFA</b>																	
 <b>12433</b>	17	21¾	79½	30½	29¾	7½	120	7,310	7,655	8,130	11,790	12,970	13,435	8,020	8,670	9,370	10,100
<b>FOUR SEAT SOFA</b>																	
 <b>12434</b>	17	21¾	104	30½	29¾	9	150	8,885	9,330	9,890	14,505	15,975	16,575	9,740	10,525	11,360	12,230
<b>OTTOMAN</b>																	
 <b>12425</b>	17		25	25	17	2¾	24	1,755	1,850	2,055	2,670	2,900	3,005	2,020	2,255	2,515	2,780

**Tuxedo Classic with legs passes CAL 133 certified for an upcharge of \$440 list per chair, \$870 list per two seat sofa, \$1305 list per three seat sofa, \$1735 list per four seat sofa, and \$380 list per ottoman. Certification applies to Nienkämper leathers and fabrics that have a minimum of 50% natural fibre content. COM's and COL's are subject to approval. Add the extension -CAL to the model number when ordering.**

Tuxedo Classic is offered without a welting detail. Seat and back cushions have a foam core with Dacron wrap. Back cushions are attached to the frame. Seat cushions are loose.

Square tubular legs made of aluminum are available in a brushed finish. A polished finish is available for an upcharge of \$140 per chair or sofa.

The swivel disk base is upholstered to match the frame.





**Model #12431**  
Lounge chair fully upholstered in leather



# LOUNGE SEATING

Tuxedo Classic™ Low Arm with Tufting Designer – Nienkämper

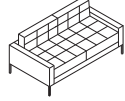
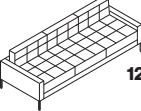
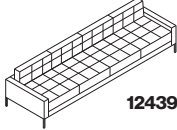
— US Only —

Model Number	Seat H"	Arm H"	W"	D"	H"	Fabric Yds.	Leather Sq.Ft.	COM	COL	Neather	Verde	Grano	Cremoso	Knoll Textiles			
														1	2	3	4
<b>LOUNGE CHAIR ON LEGS</b>																	
 <b>12436</b>	17	21¼	30½	30½	29¾	4½	72	4,045	4,245	4,540	6,740	7,440	7,730	4,470	4,865	5,280	5,720
<b>LOUNGE CHAIR - SWIVEL BASE</b>																	
 <b>12444</b>	17	21¼	30½	30½	29¾	5½	72	3,875	4,055	4,345	6,460	7,125	7,380	4,395	4,875	5,390	5,920
<b>TWO SEAT SOFA</b>																	
 <b>12437</b>	17	21¼	55	30½	29¾	6	96	5,955	6,260	6,640	9,550	10,495	10,880	6,530	7,050	7,610	8,190
<b>THREE SEAT SOFA</b>																	
 <b>12438</b>	17	21¼	79½	30½	29¾	7½	120	7,870	8,265	8,725	12,370	13,545	14,025	8,580	9,230	9,935	10,660
<b>FOUR SEAT SOFA</b>																	
 <b>12439</b>	17	21¼	104	30½	29¾	9	150	9,640	10,120	10,650	15,260	16,730	17,325	10,495	11,280	12,115	12,985
<b>OTTOMAN</b>																	
 <b>12430</b>	17		25	25	17	2¾	24	1,920	2,015	2,205	2,805	3,045	3,145	2,175	2,410	2,680	2,935

**Tuxedo Classic with legs passes CAL 133 certified for an upcharge of \$440 list per chair, \$870 list per two seat sofa, \$1305 list per three seat sofa, \$1735 list per four seat sofa, and \$380 list per ottoman. Certification applies to Nienkämper leathers and fabrics that have a minimum of 50% natural fibre content. COM's and COL's are subject to approval. Add the extension -CAL to the model number when ordering.**

Tuxedo Classic with tufting is offered with a welting detail on seat and back cushions. Seat and back cushions have a foam core with Dacron wrap. Back cushions are attached to the frame. Seat cushions are loose.





Square tubular legs made of aluminum are available in a brushed finish. A polished finish is available for an upcharge of \$140 per chair or sofa.

The swivel disk base is upholstered to match the frame.

# LOUNGE SEATING

Tuxedo Classic™ High Arm Designer – Nienkämper

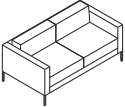
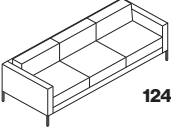
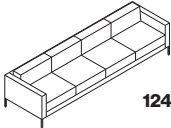
— US Only —

Model Number	Seat H"	Arm H"	W"	D"	H"	Fabric Yds.	Leather Sq.Ft.	COM	COL	Neather	Verde	Grano	Cremoso	Knoll Textiles			
														1	2	3	4
<b>LOUNGE CHAIR ON LEGS</b>																	
 <b>12421</b>	17	28	30½	30½	29¾	4½	72	3,905	4,105	4,410	6,600	7,325	7,595	4,330	4,715	5,140	5,580
<b>LOUNGE CHAIR - SWIVEL BASE</b>																	
 <b>12441</b>	17	28	30½	30½	29¾	4½	72	3,735	3,930	4,230	6,330	6,995	7,295	4,160	4,560	4,980	5,415
<b>TWO SEAT SOFA</b>																	
 <b>12422</b>	17	28	55	30½	29¾	6	96	5,655	5,935	6,325	9,320	10,185	10,490	6,225	6,750	7,310	7,890
<b>THREE SEAT SOFA</b>																	
 <b>12423</b>	17	28	79½	30½	29¾	7½	120	7,400	7,770	8,240	11,885	13,080	13,540	8,105	8,760	9,450	10,180
<b>FOUR SEAT SOFA</b>																	
 <b>12424</b>	17	28	104	30½	29¾	9	150	8,985	9,430	9,995	14,595	16,080	16,670	9,835	10,625	11,460	12,330
<b>OTTOMAN</b>																	
 <b>12425</b>	17		25	25	17	2¾	24	1,755	1,850	2,055	2,670	2,900	3,005	2,020	2,255	2,515	2,780

**Tuxedo Classic passes CAL 133 certified for an upcharge of \$440 list per chair, \$870 list per two seat sofa, \$1305 list per three seat sofa, \$1735 list per four seat sofa, and \$380 list per ottoman. Certification applies to Nienkämper leathers and fabrics that have a minimum of 50% natural fibre content. COM's and COL's are subject to approval. Add the extension -CAL to the model number when ordering.**

**Model #12421**  
Lounge chair fully upholstered in leather



Tuxedo Classic is offered without a welting detail. Seat and back cushions have a foam core with Dacron wrap. Back cushions are attached to the frame. Seat cushions are loose.





Square tubular legs made of aluminum are available in a brushed finish. A polished finish is available for an upcharge of \$140 per chair or sofa.

The swivel disk base is upholstered to match the frame.

# LOUNGE SEATING

Tuxedo Classic™ High Arm with Tufting Designer – Nienkämper

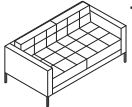
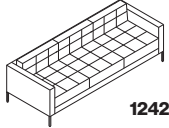
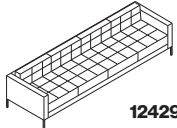
— US Only —

Model Number	Seat H"	Arm H"	W"	D"	H"	Fabric Yds.	Leather Sq. Ft.	COM	COL	Neather	Verde	Grano	Cremoso	Knoll Textiles			
														1	2	3	4
<b>LOUNGE CHAIR ON LEGS</b>																	
 <b>12426</b>	17	28	30½	30½	29¾	4½	72	4,140	4,345	4,645	6,860	7,550	7,820	4,570	4,960	5,380	5,815
<b>LOUNGE CHAIR - SWIVEL BASE</b>																	
 <b>12442</b>	17	28	30½	30½	29¾	5½	72	4,035	4,155	4,445	6,540	7,210	7,500	4,560	5,030	5,550	6,080
<b>TWO SEAT SOFA</b>																	
 <b>12427</b>	17	28	55	30½	29¾	6	96	6,065	6,365	6,720	9,645	10,600	10,980	6,640	7,155	7,715	8,295
<b>THREE SEAT SOFA</b>																	
 <b>12428</b>	17	28	79½	30½	29¾	7½	120	7,980	8,365	8,810	12,470	13,640	14,135	8,685	9,340	10,045	10,765
<b>FOUR SEAT SOFA</b>																	
 <b>12429</b>	17	28	104	30½	29¾	9	150	9,740	10,215	10,750	15,355	16,830	17,420	10,585	11,380	12,215	13,085
<b>OTTOMAN</b>																	
 <b>12430</b>	17		25	25	17	2¾	24	1,920	2,015	2,205	2,805	3,045	3,145	2,770	3,550	4,390	5,260

**Tuxedo Classic passes CAL 133 certified for an upcharge of \$440 list per chair, \$870 list per two seat sofa, \$1305 list per three seat sofa, \$1735 list per four seat sofa, and \$380 list per ottoman. Certification applies to Nienkämper leathers and fabrics that have a minimum of 50% natural fibre content. COM's and COL's are subject to approval. Add the extension -CAL to the model number when ordering.**

Tuxedo Classic with tufting is offered with a welting detail on seat and back cushions. Seat and back cushions have a foam core with Dacron wrap. Back cushions are attached to the frame. Seat cushions are loose.

Square tubular legs made of aluminum are available in a brushed finish. A polished finish is available for an upcharge of \$140 per chair or sofa.

The swivel disk base is upholstered to match the frame.

**Model #12426  
Lounge chair**



**Model #12427  
Two seat sofa**



**Model #12427  
Two seat sofa**



**Model #12428  
Three seat sofa**



# LOUNGE SEATING

Tuxedo™ Cove Designer – Nienkämper

— US Only —

Model Number	Seat H"	Arm H"	W"	D"	H"	Fabric Yds.	Leather Sq.Ft.	COM	COL	Verde	Grano	Cremoso	Knoll Textiles			
													1	2	3	4

## TUXEDO™ COVE THREE SEAT SOFA LEFT

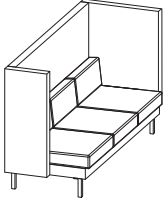

<b>12449</b>	17	46	79¼	31	46	12	216										
COM Frame						8¼	149										
COM Seat & Back Cushion						4½	81										

10,050	10,550	15,090	16,840	17,440	11,185	12,225	13,345	14,505
--------	--------	--------	--------	--------	--------	--------	--------	--------

## TUXEDO™ COVE THREE SEAT SOFA RIGHT

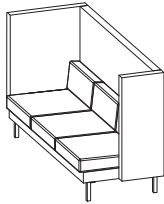

<b>12450</b>	17	46	79¼	31	46	12	216										
COM Frame						8¼	149										
COM Seat & Back Cushion						4½	81										

10,050	10,550	15,090	16,840	17,440	11,185	12,225	13,345	14,505
--------	--------	--------	--------	--------	--------	--------	--------	--------

## INTERCONNECTING PANEL

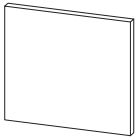

<b>12451</b>			44	3	38¾	2¾	50										
--------------	--	--	----	---	-----	----	----	--	--	--	--	--	--	--	--	--	--

2,345	2,465	3,845	4,115	4,245	2,600	2,835	3,105	3,360
-------	-------	-------	-------	-------	-------	-------	-------	-------

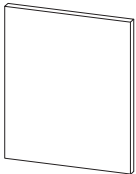

<b>12452</b>			44	3	46	3½	63										
--------------	--	--	----	---	----	----	----	--	--	--	--	--	--	--	--	--	--

2,835	2,980	4,725	5,055	5,225	3,175	3,480	3,810	4,140
-------	-------	-------	-------	-------	-------	-------	-------	-------

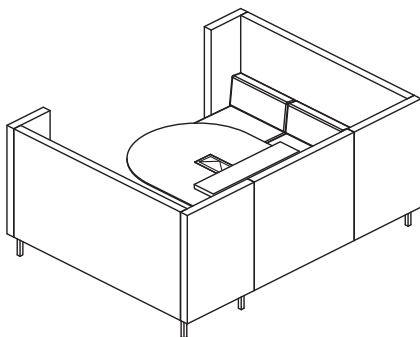

Tuxedo™ Cove Sofa with interconnecting panel  
Model # 12451

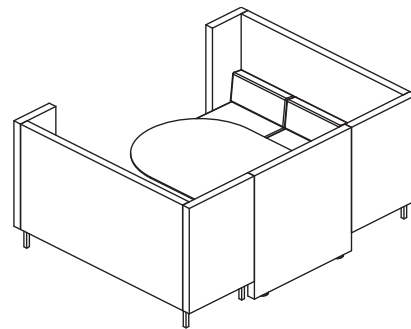

Tuxedo™ Cove Sofa with interconnecting panel  
Model # 12452  
panel with integrated cavity for wire management

## LOUNGE SEATING

Tuxedo™ Cove & Gateway™ Media Lift/Wall Mounted Table Designer – Nienkämper & busk + hertzog

Tuxedo™ Cove is composed of two 3 seat high back sofas with an interconnecting panel and table to form an enclosed booth for meetings, collaborative tasks or to be used as a touchdown base for the day. The high sides and back provide total seclusion from the surrounding environment without the need for interior substructures while additional privacy is maintained via the acoustic benefits of the interconnecting panel and the sofas high walls.

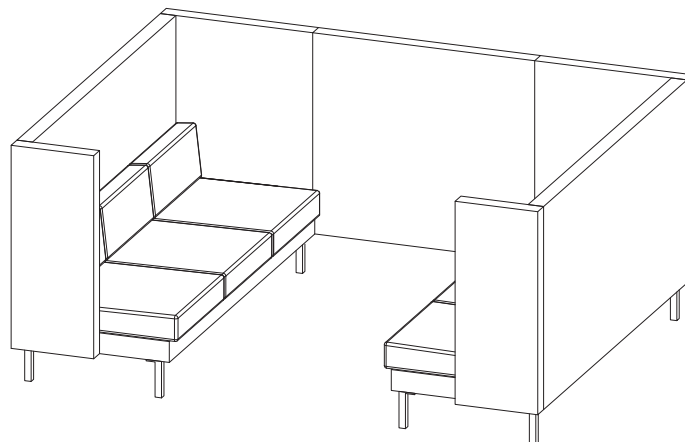

# LOUNGE SEATING

Tuxedo™ Cove & Gateway™ Media Lift Table Designer – Nienkämper & busk + hertzog

Table options for Tuxedo™ Cove include the Gateway™ tables, with a full range of connectivity. The Gateway™ Media Lift Table with Relaxed Work Height (26" H) provides a free standing solution while the Gateway™ Wall Mounted Table with Relaxed Work Height (26" H) offers another option for television screen and monitor to be mounted on the interconnecting panel.

Gateway™ Media Lift Table effortlessly transforms meeting tables to create innovative multimedia solutions for communication, presentations and interactive work spaces. At the touch of the remote control, the unit raises the monitor screen up from the base cabinet. The ultimate in professional appearance, Gateway™ Media Lift combines sophistication and function to create additional space, protect your TV from damage or to hide it away from sight.

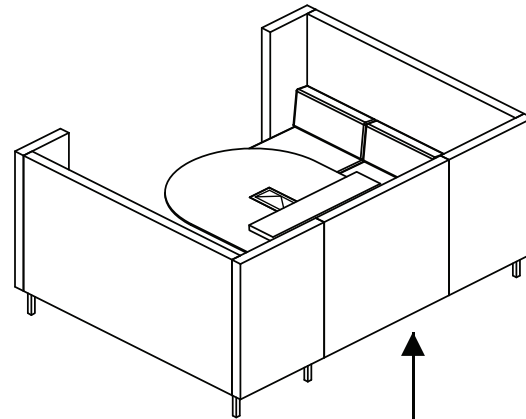

interconnecting panel: 39" h  
**Model # 12451**

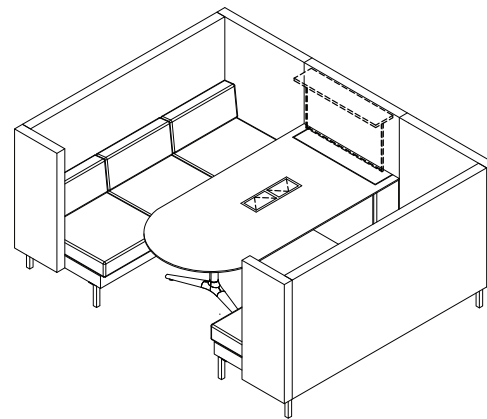
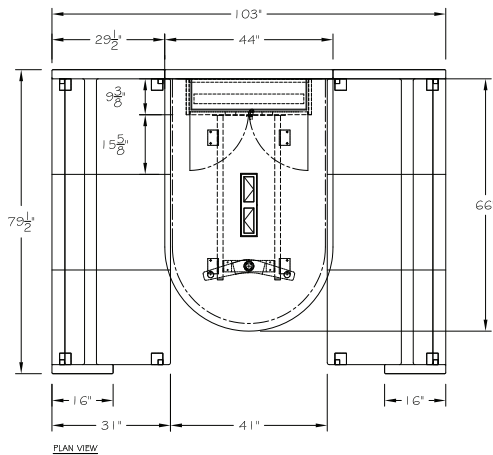

Model #	Description	Quantity	List Price
<b>12449</b>	Tuxedo™ Cove Three Seat Sofa Left in COM	1	10,050
<b>12450</b>	Tuxedo™ Cove Three Seat Sofa Right in COM	1	10,050
<b>12451</b>	Interconnecting Panel (39" H) in COM	1	2,345
<b>43031/5</b>	Gateway Media Lift Table – Relaxed Work Height 26" H in Standard P-lam	1	12,880
<b>85213</b>	Simple Side by Side Pop Up Forum Each side with two power & two open ports	1	1,325
<b>Total List:</b>			<b>36,630</b>

**Note:**

- Gateway™ Media Lift Table Dimension 66" L x 44" D x 26" H.
- For standard veneer finish, model #43031/2, list price is \$14,040
- TV lift can accommodate a maximum TV size of 32".
- TV lift is included. TV is not included.



# LOUNGE SEATING

Tuxedo™ Cove & Gateway™ Wall Mounted Table Designer – Nienkämper & busk + hertzog

Gateway™ Wall Mounted Table provides a simple solution by mounting a TV or monitor screen directly onto the interconnecting panel. The wall mounted Gateway™ table with single base provides maximum knee space for users.

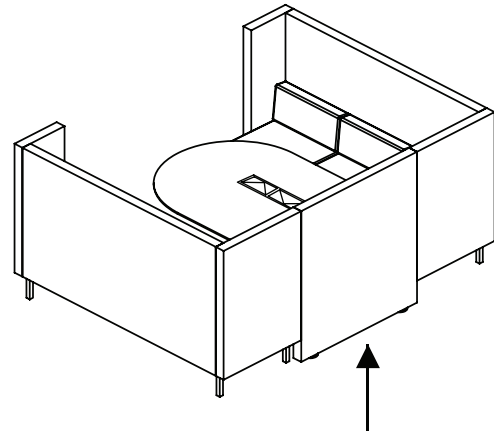

interconnecting panel: 46" h  
Model # 12452

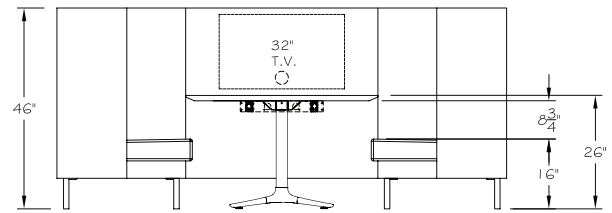
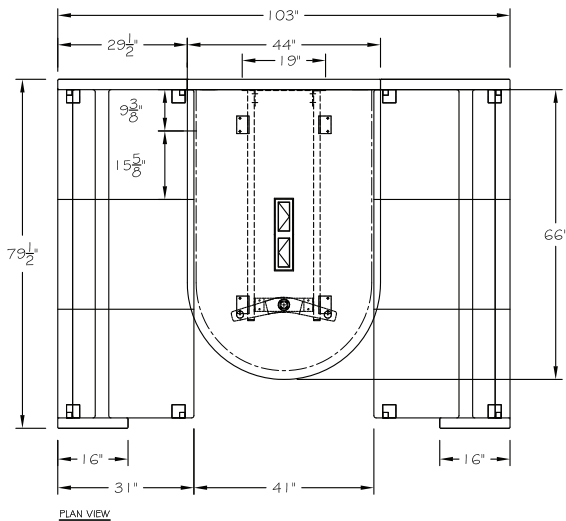

Model #	Description	Quantity	List Price
12449	Tuxedo™ Cove Three Seat Sofa Left in COM	1	10,050
12450	Tuxedo™ Cove Three Seat Sofa Right in COM	1	10,050
12452	Interconnecting Panel (46" H) in COM	1	2,835
43041/5	Gateway Wall Mounted Table – Relaxed Work Height 26" H in Standard P-lam	1	6,640
85213	Simple Forum Side by Side Each side with two power & two open ports	1	1,325
<b>Total List:</b>			30,885



**Note:**

- Gateway Wall Mounted Table Dimension 66" L x 44" D x 26" H.
- For standard veneer finish, model # 43041/2, list price is \$7,795
- Maximum TV size to be mounted on panel is 32".
- TV & TV mount are not included.

# LOUNGE SEATING

Tuxedo™ High Back Designer – Nienkämper

— US Only —

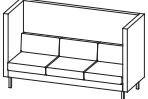
Model Number	Seat			D"	H"	Fabric Yds.	Leather Sq.Ft.	COM	COL	Verde	Grano	Cremoso	Knoll Textiles								
	H"	H"	W"										1	2	3	4					
<b>TWO SEAT SOFA</b>																					
	<b>12445</b>	17	46	55	31	46	9¼	167	7,910	8,305	12,320	13,780	14,265	8,785	9,590	10,455	11,340				
	COM Frame						6¾	112													
	COM Seat & Back Cushion						3	54													
<b>LARGE TWO SEAT SOFA</b>																					
	<b>12447</b>	17	46	64	31	46	11¼	203	9,200	9,645	14,330	16,030	16,605	10,265	11,245	12,295	13,380				
	COM Frame						7½	135													
	COM Seat & Back Cushion						3¾	68													
<b>THREE SEAT SOFA</b>																					
	<b>12446</b>	17	46	79½	31	46	12½	225	10,575	11,105	15,955	17,755	18,350	11,760	12,850	14,020	15,225				
	COM Frame						8¾	157													
	COM Seat & Back Cushion						4½	81													

Tuxedo™ High Back passes CAL 133 certified for an upcharge of \$870 list per two seat sofa and \$1305 list per three seat sofa. Certification applies to Nienkämper leathers and fabrics that have a minimum of 50% natural fibre content. COM's and COL's are subject to approval. Add the extension -CAL to the model number when ordering.

Model # 12446  
Tuxedo High Back 3 Seat Sofa



# LOUNGE SEATING

Tuxedo™ High Back Designer – Nienkämper

— US Only —

Model Number	Seat Arm			D"	H"	Fabric Yds.	Leather Sq.Ft.	COM	COL	Verde	Grano	Cremoso	Knoll Textiles			
	H"	H"	W"										1	2	3	4

## HIGH BACK LOUNGE CHAIR



<b>12448</b>	17	46	37¼	31	46	8	144	5,935	6,925	9,915	10,485	10,765	6,690	7,385	8,135	8,910
COM Frame						6½	117									
COM Seat & Back Cushion						2	36									

## ACCESSORIES

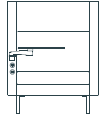

Lounge chair with tablet & power

## ARM SIDE CUSHION

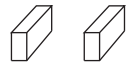

<b>12460</b>			19	3	7	¾	14	855	900	1,285	1,360	1,400	925	990	1,065	1,135
--------------	--	--	----	---	---	---	----	-----	-----	-------	-------	-------	-----	-----	-------	-------

Note: Dimension is for one piece. List price & yardage is for a set of two pieces

## TABLET

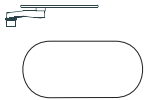

<b>12461</b>			20	12	½			1,505								
--------------	--	--	----	----	---	--	--	-------	--	--	--	--	--	--	--	--

## Features

**Cushion:** Seat and back cushions have a foam core with Dacron wrap. Back cushions are attached to the frame. Seat cushions are loose.

**Legs:** Square tubular legs made of cast aluminum are available in a brushed finish. A polished finish is available for an upcharge of \$130 list per chair or sofa.

**Tablet:** Fingerprint resistance solid plastic laminate top in ½" thick, colour available in pure white or black, with silver or white powder coat arm support

**Power:** Standard with satin nickel frame, white receptacles and 72" cords.

## Vox Simple Dot Forums with Trim



Satin nickel trim with white receptacle, model # 11864NW \$285 List



Satin nickel trim with white stacked USB, model # 11865NW \$490 list



Satin nickel trim with black receptacle, model # 11864NB \$285 list



Satin nickel trim with black stacked USB, model # 11865NB \$490 list

## Vox Simple Dot Forums



White receptacle, model # 11867/W \$??? List



White stacked USB, model # 11868/W \$??? list



Black receptacle, model # 11967/B \$??? List



Black stacked USB, model # 11868/B \$??? list



2 Port, power & USB charger white, model # 11866W \$930 list



2 Port, power & USB charger black, model # 11866/B \$930 list

**Model # 12448**  
Tuxedo High Back Lounge Chair upholstered in Verde leather / Graphite VE 6008 with arm side cushion, tablet & power

**Model # 12448**



# LOUNGE SEATING

Vuelo Lounge Designer - johnson chou

— US Only —

Model Number	Seat H"	Arm H"	W"	D"	H"	Fabric Leather		COM	COL	Neather	Verde	Grano	Cremoso	KNOLL TEXTILES			
						Yds.	Sq.Ft.							1	2	3	4

## VUELO LOUNGE CHAIR HIGH BACK



Model	Seat H"	Arm H"	W"	D"	H"	Fabric Yds.	Leather Sq.Ft.	COM	COL	Neather	Verde	Grano	Cremoso	KNOLL TEXTILES 1	KNOLL TEXTILES 2	KNOLL TEXTILES 3	KNOLL TEXTILES 4
10073	15	20	29	30	41	3	54	4,020	4,225	4,320	5,695	5,985	6,125	4,295	4,565	4,845	5,135
10073/1						2		4,020		4,320				4,215	4,380	4,570	4,765
							1										
10073/2						36			4,225		5,695	5,985	6,125				
							18										
10073/3						2		4,710						4,905	5,075	5,265	5,455
							18										

## VUELO OTTOMAN



Model	Seat H"	Arm H"	W"	D"	H"	Fabric Yds.	Leather Sq.Ft.	COM	COL	Neather	Verde	Grano	Cremoso	KNOLL TEXTILES 1	KNOLL TEXTILES 2	KNOLL TEXTILES 3	KNOLL TEXTILES 4
10074	15	20	29	29	15	1	18	1,355	1,425	1,455	1,915	2,015	2,055	1,450	1,535	1,630	1,730

Model # 10073 & 10074



### Standard features:

- Moulded plywood seat and arm shell
- Soy based flexible polyurethane foam
- Polished aluminum 4-star base on glides
- For model /3 with fabric seat & back and verde leather arms & bottom, welding detail on the back in same Verde leather is standard

# LOUNGE SEATING

Wavelength® Designer - karim rashid

— US Only —

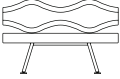
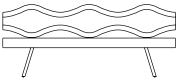
Model Number	Seat H"	W"	D"	H"	Fabric Leather		COM	COL	Verde	Grano	Cremoso	Knoll Textiles							
					Yds.	Sq.Ft.						1	2	3	4				
<b>CHAIR</b>																			
	1401_	16¾	23¾	31	30¾														
	(Model #1)	Fully upholstered				1½	24	3,445	3,620	4,300	4,535	4,630	3,580	3,705	3,840	3,980			
	(Model #2)	Fabric seat & back, fabric contrasting trim				¾	¾	3,445					3,515	3,570	3,645	3,715			
(Model #3)	Leather seat & back, leather contrasting trim				12	12		3,620	4,300	4,535	4,630								
<b>TWO SEAT SOFA</b>																			
	1402_	16¾	47¾	31	30¾														
	(Model #1)	Fully upholstered				3	48	4,075	4,285	5,800	6,235	6,420	4,350	4,595	4,865	5,140			
	(Model #2)	Fabric seat & back, fabric contrasting trim				1½	1½	4,075					4,215	4,340	4,470	4,610			
(Model #3)	Leather seat & back, leather contrasting trim				24	24		4,285	5,800	6,235	6,420								
<b>THREE SEAT SOFA</b>																			
	1403_	16¾	70¾	31	33														
	(Model #1)	Fully upholstered				4½	72	4,725	4,955	7,290	7,965	8,240	5,130	5,505	5,905	6,325			
	(Model #2)	Fabric seat & back, fabric contrasting trim				2¼	2¼	4,725					4,930	5,115	5,315	5,525			
(Model #3)	Leather seat & back, leather contrasting trim				36	36		4,955	7,290	7,965	8,240								

Wavelength passes CAL 133 certified for an upcharge of \$440 list per chair, \$870 list per 2 seat sofa and \$1,305 list per 3 seat sofa. Certification applies to Nienkämper leathers and fabrics that have a minimum of 50% natural fibre content. COM's and COL's are subject to approval. Add the extension -CAL to the model number when ordering.

**Fabric direction when railroaded**

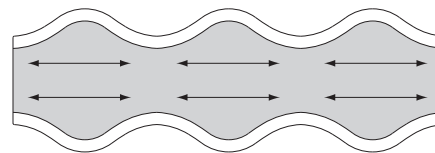

Fabric yardages are based on plain fabrics with no apparent pattern direction. Fabric is railroaded.

When upholstering in two different fabrics or leathers use the COM price or COL price and ship yardages or square footage as noted on page 6. Most fabrics and vinyl are suitable for the top seat portion but the contrasting trim must have stretch.

Nienkämper reserves the right to determine the suitability of COM on our furniture. For further details regarding approvals, refer to page 6.

Specify polished or brushed aluminum frame

**Model #14012**  
Contrasting trim,  
polished aluminum frame



**Model #14032**  
Contrasting trim,  
polished aluminum frame



**Model #14031**  
Fully upholstered,  
polished aluminum frame

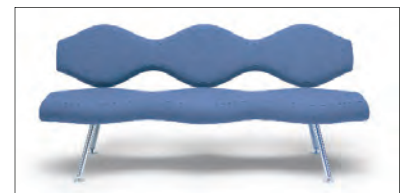



Fabric to be upholstered on Wavelength requires approval from Nienkämper's factory. Please contact customer service at 800 668 9318 for our fabric approval list.

# LOUNGE SEATING

Wavelength® Designer - karim rashid

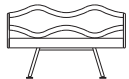
— US Only —

Model Number	Seat H"	W"	D"	H"	Fabric		COM	COL	Verde	Grano	Cremoso	Knoll Textiles						
					Yds.	Sq.Ft.						1	2	3	4			
<b>CHAIR WITH ARM</b>																		
	1401_	16 3/4	23 3/8	31	30 3/4													
	(Model #7)	Fully Upholstered				1 1/2	24	5,430	5,710	6,330	6,565	6,680	5,575	5,705	5,840	5,995		
	(Model #8)	Fabric seat & back, fabric contrasting trim				3/4	3/4	5,445					5,525	5,585	5,655	5,730		
	(Model #9)	Leather seat & back, leather contrasting trim				12	12		5,710	6,330	6,565	6,680						
<b>TWO SEAT SOFA WITH ARM</b>																		
	1402_	16 3/4	47 1/4	31	30 3/4													
	(Model #7)	Fully Upholstered				3	48	6,105	6,395	7,895	8,355	8,560	6,380	6,650	6,925	7,220		
	(Model #8)	Fabric seat & back, fabric contrasting trim				1 1/2	1 1/2	6,105					6,240	6,370	6,520	6,665		
	(Model #9)	Leather seat & back, leather contrasting trim				24	24		6,395	7,895	8,355	8,560						
<b>THREE SEAT SOFA WITH ARM</b>																		
	1403_	16 3/4	70 3/8	31	33													
	(Model #7)	Fully Upholstered				4 1/2	72	6,780	7,125	9,475	10,180	10,470	7,210	7,600	8,020	8,455		
	(Model #8)	Fabric seat & back, fabric contrasting trim				2 1/4	2 1/4	6,780					6,995	7,190	7,405	7,625		
	(Model #9)	Leather seat & back, leather contrasting trim				36	36		7,125	9,475	10,180	10,470						

Wavelength passes CAL 133 certified for an upcharge of \$440 list per chair, \$870 list per 2 seat sofa and \$1,305 list per 3 seat sofa. Certification applies to Nienkämper leathers and fabrics that have a minimum of 50% natural fibre content. COM's and COL's are subject to approval. Add the extension -CAL to the model number when ordering.

**Fabric direction when railroaded**

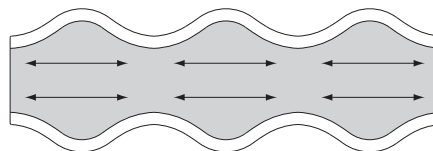

Fabric yardages are based on plain fabrics with no apparent pattern direction. Fabric is railroaded.

When upholstering in two different fabrics or leathers use the COM price or COL price and ship yardages or square footage as noted on page 6. Most fabrics and vinyl are suitable for the top seat portion but the contrasting trim must have stretch.

Nienkämper reserves the right to determine the suitability of COM on our furniture. For further details regarding approvals, refer to page 6.

Specify polished or brushed aluminum frame

Fabric to be upholstered on Wavelength requires approval from Nienkämper's factory. Please contact customer service at 800 668 9318 for our fabric approval list.

**Model #14037**  
Polished aluminum frame and arms

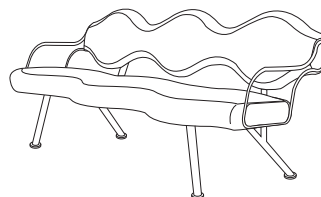

**Arms with table on both sides available at an upcharge of \$720 each or \$1440 a pair**

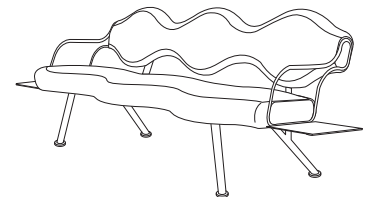

# LOUNGE SEATING

Work:Recline Designer - 5D Studio

— US Only —

Model Number	Seat H"	Arm H"	W"	D"	H"	Fabric		COM	COL	Verde	Grano	Cremoso	Knoll Textiles			
						Yds.	Sq.Ft.						1	2	3	4

## WORK:RECLINE CHAIR

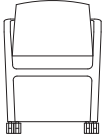

<b>11000</b>	18	24½	25	26	33	3¾	68	3,695	3,885	5,325	5,685	6,040	4,050	4,375	4,720	5,090
--------------	----	-----	----	----	----	----	----	-------	-------	-------	-------	-------	-------	-------	-------	-------

**Unique feature:** reclining back, forward sliding seat pan.

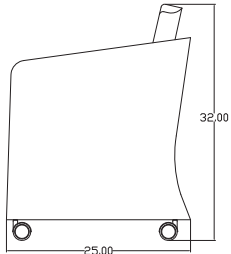

UPRIGHT

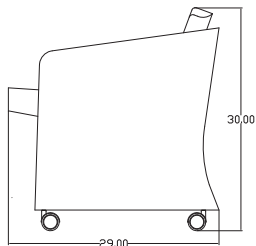

RECLINED

Model #11000



Model #11000



Model #11000



### Standard features:

- Upholstered in fabric, leather or a combination, the chair is hardwood construction soy based foam cushions. Black casters are standard.

# LOUNGE SEATING

Yabaco Designer – Ryann Aoukar & Damien Robache

– US Only –

Model Number	Seat H"	Arm H"	W"	D"	H"	Fabric Yds.	Leather Sq.Ft.	COM	COL	Verde	Grano	Cremoso	Knoll Textiles			
													1	2	3	4

## YABACO CHAIR

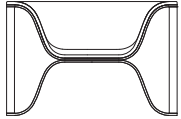

<b>15130</b>	15	27¼	36½	26¼	28	3	54	4,550	4,785	6,215	6,670	6,860	4,830	5,095	5,380	5,665
--------------	----	-----	-----	-----	----	---	----	-------	-------	-------	-------	-------	-------	-------	-------	-------

Solid bar stock steel frame, Brushed Nickel finish  
Polished chrome available, upcharge \$760 list

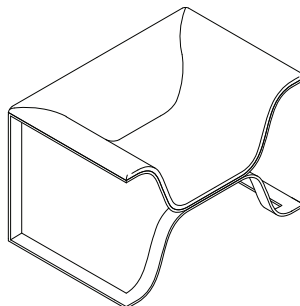
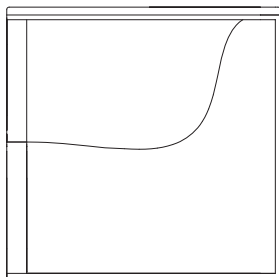







# LOUNGE SEATING

Zurich Designer – Nienkämper & robert haussmann

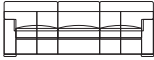
— US Only —

Model Number	Seat H"	Arm H"	W"	D"	H"	Fabric Yds.	Leather Sq.Ft.	COM	COL	Verde	Grano	Cremoso	Knoll Textiles					
													1	2	3	4		
<b>LOUNGE CHAIR</b>																		
	<b>460</b>	17½	21	33	35	30	6½	95	6,900	7,210	10,445	11,380	11,750	7,530	8,035	8,230	8,350	
<b>TWO SEAT SOFA</b>																		
	<b>460-2</b>	17½	21	56	35	30	8¾	140	9,545	10,015	14,790	16,165	16,720	10,405	11,105	11,360	11,515	
<b>THREE SEAT SOFA</b>																		
	<b>460-3</b>	17½	21	79	35	30	11¾	185	12,470	13,090	19,385	21,220	21,930	13,620	14,550	14,880	15,105	
<b>FOUR SEAT SOFA</b>																		
	<b>460-4</b>	17½	21	102	35	30	14	230	15,515	16,300	24,130	26,400	27,310	16,905	18,005	18,430	18,705	
<b>OTTOMAN</b>																		
	<b>460-5</b>			28	28	17	3	48	3,845	4,045	5,650	6,120	6,300	4,140	4,375	4,470	4,535	

Zurich series passes CAL 133 certified for an upcharge of \$490 list per chair, \$975 list per two seater sofa, \$1460 list per three seat sofa, \$1945 list per four seat sofa, and \$485 list per ottoman. Certification applies to Nienkämper leathers and fabrics that have a minimum of 50% natural fibre content. COM's and COL's are subject to approval. Add the extension -CAL to the model number when ordering.

When COM is lightweight, a welting detail is added to the perimeter of the seat and back cushions. Allow 5% additional yardage of COM to accommodate welting details.

When upholstered in leather, seat and back cushions have a foam core wrapped in a down and feather combination.

When upholstered in COM, seat and back cushions have a foam core wrapped in Dacron.

All seat and back cushions are loose.

Two base options are available. Radius feet, see photo on page 58, are offered ebonized as standard. Angled wood feet, see photo on page 58, are offered ebonized as standard. Both Radius and Angled feet are available in standard Nienkämper stains, see page 12 for a listing. To match custom stains add \$60 list per stain color.

Model #460



Model #460-2



Model #460-3



# LOUNGE SEATING

Zurich Designer – Nienkämper & robert haussmann

— US Only —

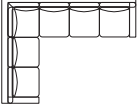
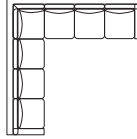
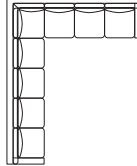
Model Number	Seat H"	Arm H"	W"	D"	H"	Fabric Yds.	Leather Sq.Ft.	COM	COL	Verde	Grano	Cremoso	Knoll Textiles					
													1	2	3	4		
<b>SIX SEAT L-SHAPED SOFA</b>																		
	<b>460-6</b>	17½	21	1109	86	30	20	320	24,280	25,495	36,255	39,415	40,660	26,250	27,815	28,415	28,820	
<b>SEVEN SEAT L-SHAPED SOFA</b>																		
	<b>460-7</b>	17½	21	109	109	30	28	365	27,815	29,220	41,490	45,080	46,505	30,095	31,900	32,590	33,040	
<b>EIGHT SEAT L-SHAPED SOFA</b>																		
	<b>460-8</b>	17½	21	109	109	30	26	410	31,305	32,880	46,665	50,685	52,315	33,865	35,910	36,695	37,200	

Zurich series passes CAL 133 certified for an upcharge of \$2915 list for six seat, \$3400 list for seven seat, and \$3885 list for eight seat. Certification applies to Nienkämper leathers and fabrics that have a minimum of 50% natural fibre content. COM's and COL's are subject to approval. Add the extension -CAL to the model number when ordering.

When COM is lightweight, a welting detail is added to the perimeter of the seat and back cushions. Allow 5% additional yardage of COM to accommodate welting details.

When upholstered in leather, seat and back cushions have a foam core wrapped in a down and feather combination.

When upholstered in COM, seat and back cushions have a foam core wrapped in Dacron.

All seat and back cushions are loose.

Two base options are available. Radius feet, see photo below left, are offered ebonized as standard. Angled wood feet, see photo below right, are offered ebonized as standard. Both Radius and Angled feet are available in standard Nienkämper stains, see page 12 for a listing. To match custom stains add \$600 list per stain color.

Radius Foot



Angled Foot



# nienkämper

International Inc.

## STOOLS AND BENCHES



# STOOLS AND BENCHES

## TABLE OF CONTENTS

---

<b>Stools and Benches</b>	<b>155-177</b>
32 Bench	157
Align	158
Blottoman™	159
Caravite	160
Corbu	161
Elevation™ Bench	162
Exhale	163
Hocker Stool	164
Jackal	165
Kloud® Benches	166
Max™ Benches	167
Mint	168
Moment Collection	169
Nienkämper River	170-171
Patkau Bench	172
Pullman™ Benches	173
Six® Collection Benches	174
Spin Stool/Tables	175
Wavelength® Benches	176
Zoo Stools	177

# STOOLS AND BENCHES

32 Collection

— US Only —

Model Number	Seat H"	Arm H"	W"	D"	H"	Fabric Yds.	Leather Sq.Ft.	COM	COL	Neather	Verde	Grano	Cremoso	Knoll Textiles			
														1	2	3	4

## 32 BENCH SMALL (4 SQUARES X 9 SQUARES)

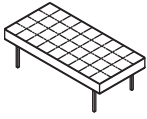

32031	17	54	26	17	2½	45		2,855	2,995	3,085	4,165	4,390	4,500	3,090	3,305	3,540	3,780
-------	----	----	----	----	----	----	--	-------	-------	-------	-------	-------	-------	-------	-------	-------	-------

## 32 BENCH LARGE (4 SQUARES X 14 SQUARES)

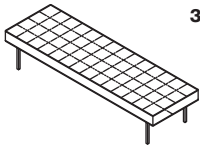

32032	17	84	26	17	4	72		3,565	3,745	3,935	5,615	5,975	6,155	3,945	4,290	4,670	5,055
-------	----	----	----	----	---	----	--	-------	-------	-------	-------	-------	-------	-------	-------	-------	-------

### Standard features:

- Standard with tufting on bench.
- Plywood frame with soy based polyurethane foam.
- Support frame & legs are standard in brushed aluminum finish.
- Powder coat finishes also available upon request.

Model # 32031  
32 Bench Small



# STOOLS AND BENCHES

Align Designer - Nienkämper

— US Only —

Model Number	Seat H"	W"	D"	H"	Fabric		COM	COL	Neather	Verde	Grano	Cremoso	Knoll Textiles									
					Yds.	Sq.Ft.							1	2	3	4						
<b>10880</b>	23-32	15	15	23-32	¾	12							1,930	2,030	1,995	2,340	2,395	2,430	1,985	2,050	2,115	2,175

## ALIGN STOOL

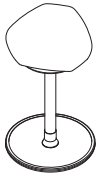

### Standard features:

- Comfortable triangular seat with polyurethane foam.
- Seat height is adjustable from seating to standing height (23-32"H) with anti-twist gas spring.
- Base is standard in black with curved foot.



Model # 10880



# STOOLS AND BENCHES

Blottoman™ Benches Designer - karim rashid

— US Only —

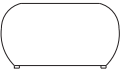
Model Number	Seat H"	W"	D"	H"	Fabric Leather		Knoll Textiles									
					Yds.	Sq.Ft.	COM	COL	Verde	Grano	Cremoso	1	2	3	4	
<b>BLOTTOMAN</b>																
	14902 Fully Upholstered	14	18	18	14	1 1/3	23	785	815	1,450	1,635	1,710	910	1,025	1,150	1,275
	14906 Contrasting fabric			Seat		1/2		785					830	870	920	970
	14907 Contrasting leather			Seat			9		815	1,450	1,635	1,710				
				Sides			9									
				Sides												
<b>BLOTTOMAN SQUARE BENCH</b>																
	14911 Fully Upholstered	17 1/2	24	24	17 1/2	1 1/3	23	1,255	1,325	2,120	2,340	2,445	1,390	1,500	1,625	1,750
	14912 Contrasting fabric			Seat		3/4		1,255					1,315	1,385	1,435	1,505
	14913 Contrasting leather			Seat			10		1,325	2,120	2,340	2,445				
				Sides			13									
				Sides												
<b>BLOTTOMAN TWO SEAT BENCH</b>																
	14914 Fully Upholstered	17 1/2	48	24	17 1/2	2 1/4	35	2,185	2,295	3,485	3,825	3,960	2,405	2,610	2,825	3,060
	14915 Contrasting fabric			Seat		1 3/4		2,185					2,350	2,495	2,645	2,805
	14916 Contrasting leather			Seat			22		2,295	3,485	3,825	3,960				
				Sides			13									
				Sides												
<b>BLOTTOMAN LARGE SQUARE BENCH</b>																
	14917 Fully Upholstered	17 1/2	34	34	17 1/2	1 3/4	30	1,955	2,050	3,080	3,380	3,490	2,120	2,260	2,410	2,575
	14918 Contrasting fabric			Seat		1 3/4		1,955					2,120	2,260	2,410	2,575
	14919 Contrasting leather			Seat			16		2,050	3,080	3,380	3,490				
				Sides			14									
				Sides												

Blottoman passes CAL 133 certified for an upcharge of \$380list per square bench; two seat bench \$760 list; large square bench \$535 list; blottoman \$285 list. Certification applies to Nienkämper leathers and fabrics that have a minimum of 50% natural fibre content. COM's and COL's are subject to approval. Add the extension "-CAL" to the model number when ordering.

The curvaceous shape and soft molded foam of the Blottoman are conducive to fabrics with some stretch and minimum pattern.

When upholstered in two different fabrics or leathers, use the COM price and ship your fabric yardage or leather square footage to Nienkämper. See page 6 for COM and COL details.

Seams can have matching or contrasting stitching. Matching or contrasting welting detail can also be specified.

\*For patterned or directional fabrics please contact Customer Service at 800.668.9318 for yardages.

Right: Model #14912  
Left: Model #14918  
Shown with a Virso occasional table, Model #32020T1



Model #14915



# STOOLS AND BENCHES

Caravite Designer - busk + hertzog

— US Only —

Model Number	Seat H"	W"	D"	H"	Fabric		COM	COL	Neather	Verde	Grano	Cremoso	Knoll Textiles			
					Yds.	Sq. Ft.							1	2	3	4

## CARAVITE STOOL



10221	31¾	18	14	31¾	¾	14	1,040	1,090	1,105	1,450	1,510	1,545	1,115	1,180	1,250	1,320
-------	-----	----	----	-----	---	----	-------	-------	-------	-------	-------	-------	-------	-------	-------	-------

## CARAVITE BENCH



10222	16½	47¾	35¾	16½	2½	41	1,730	1,820	1,935	2,860	3,060	3,150	1,965	2,180	2,410	2,665
-------	-----	-----	-----	-----	----	----	-------	-------	-------	-------	-------	-------	-------	-------	-------	-------

Model # 10222 & 10221



### Standard features:

- Distinctive contoured seat cushion with polyurethane foam and plywood frame
- Top stitch detail is standard and contrasting stitching can also be specified.
- Tubular steel frame standard with black powder coat finish, other powder coat colors are available upon request.



# STOOLS AND BENCHES

Corbu Bench & Ottoman Designer - Nienkämper

— US Only —

Model Number	Seat H"	W"	D"	Fabric		COM	COL	Verde	Grano	Cremoso	Knoll Textiles			
				Yds.	Sq.Ft.						1	2	3	4

## CORBUBENCH

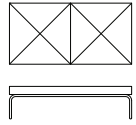

<b>11851</b>	16	60	30	2½	40	3,525	3,700	4,610	4,980	5,100	3,780	4,020	4,260	4,510
--------------	----	----	----	----	----	-------	-------	-------	-------	-------	-------	-------	-------	-------

## CORBOTTOMAN

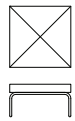

<b>11852</b>	16	30	30	2½	20	2,310	2,415	2,860	3,040	3,105	2,535	2,740	2,955	3,180
--------------	----	----	----	----	----	-------	-------	-------	-------	-------	-------	-------	-------	-------

Model #11851



Model #11852



### Standard Features

- Chrome tubular frame
- Button tufted with diamond upholstery pattern
- Cushion has 20% soy foam content

# STOOLS AND BENCHES

Elevation™ Benches Designer - Johnson Chou

— US Only —

Model Number	W"	D"	H"	FabricLeather		COM	COL	Verde	Grano	Cremoso	Knoll Textiles			
				Yds.	Sq.Ft.						1	2	3	4

## ELEVATION™ BENCH SILVER PAINTED BASE

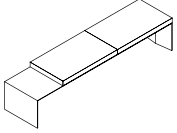

<b>23801</b>	101	24	16½	3¾	68	8,460	8,885	10,310	10,935	11,125	8,815	9,145	9,500	9,860
--------------	-----	----	-----	----	----	-------	-------	--------	--------	--------	-------	-------	-------	-------

## ELEVATION BENCH STAINLESS STEEL BASE

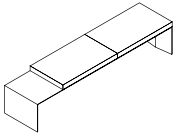

<b>23806</b>	101	24	16½	3¾	68	10,300	10,815	12,150	12,760	12,970	10,655	10,975	11,325	11,690
--------------	-----	----	-----	----	----	--------	--------	--------	--------	--------	--------	--------	--------	--------

**Elevation Bench passes CAL 133 certified for an upcharge of \$960 list per bench. Certification applies to Nienkämper leathers and fabrics that have a minimum of 50% natural fibre content. COM's and COL's are subject to approval. Add the extension "-CAL" to the model number when ordering.**

### Elevation Bench

- Cushion is 80" long.
- Price includes a silver painted base as standard. Upcharges apply for a wood veneer base, contact Customer Service for finish options and pricing.

### Model #23801

Elevation bench



# STOOLS AND BENCHES

Exhale Designer - busk + hertzog

— US Only —

Model Number	Seat H"	W"	D"	H"	Fabric Yds.	Leather Sq. Ft.	COM	COL	Neather	Verde	Grano	Cremoso	KnollTextiles			
													1	2	3	4

## EXHALE BENCH

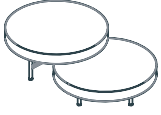

<b>10295</b>	16½ 24	80¼	48¼	16½ 24	6 yds (if same fabric is used for both circles)	108	4,300	4,515	4,810	6,960	7,465	7,710	4,885	5,425	6,005	6,595
<b>10295-1</b>	16½ 24	80¼	48¼	16½ 24	If different fabric is used for each circle; Each circle requires 4 yds	144	4,300	4,515	4,980	7,840	8,515	8,850	5,075	5,800	6,565	7,360

### Model # 10295-1

Exhale



### Exhale Bench

- Footprint Dimension: 80¼" x 48¼" x 16½" / 24"H
- Seat Element Dimension: 48¼" dia. x 6"
- Seat Material: all standard KnollTextiles and COM fabrics
- Leg Material: mild steel hollow tube
- Leg Finish: satin black powder coat
- Power Options: Byrne Dubbel, Garcia, Night Cap, Kia

# STOOLS AND BENCHES

Hocker Office Stool Designer - Nienkämper

— US Only —

Model Number	Seat H"	W"	D"	H"	Fabric		COM	COL	Neather	Verde	Grano	Cremoso	Knoll Textiles			
					Yds.	Sq.Ft.							1	2	3	4

## HOCKER OFFICE STOOL

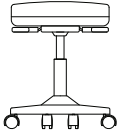

<b>15201</b>	18-21	18	18		¾	12	760	785	825	1,060	1,125	1,200	825	885	940	1,015
--------------	-------	----	----	--	---	----	-----	-----	-----	-------	-------	-------	-----	-----	-----	-------

## HOCKER OFFICE TALL STOOL

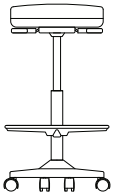

<b>15202</b>	25-35	18	18		¾	12	840	885	910	1,130	1,210	1,280	905	970	1,025	1,090
--------------	-------	----	----	--	---	----	-----	-----	-----	-------	-------	-------	-----	-----	-------	-------

### Standard features:

- Cushion has 25% soy foam content
- Pneumatic height adjustment
- Base is black
- Tall stool has polished aluminum foot ring

Model # 15201



Model # 15202



# STOOLS AND BENCHES

Jackal Stool Designer - Fig40

Model Number	W"	D"	H"	List Price
<b>JACKAL STOOL</b>				
<b>10226</b>	20¾	19½	37 ⅞	1,510



**Model # 10226**  
**Jackal Stool**





### Standard Features

- Seat Material: stripy Beech 3D veneer
- Frame Material: stainless steel rod
- Seat Finish: standard stain & finish
- Frame Finish: brushed stainless, powder coat satin black

# STOOLS AND BENCHES

Kloud® Benches Designer - Karim Rashid

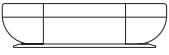
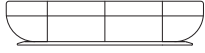



— US Only —

Model Number	Seat H"	W"	D"	Fabric		Leather									
				Yds.	Sq. Ft.	COM	COL	Verde	Grano	Cremoso	1	2	3	4	
<b>TWO SEAT BENCH</b>															
	<b>14998</b>	16	48	30	3	56	2,815	2,955	4,370	5,010	5,195	3,105	3,360	3,650	3,935
	Fully upholstered														
	<b>14977</b>	Contrasting Fabric			1½		2,815					2,960	3,090	3,235	3,380
		Top/seat													
		Bottom			1½										
	<b>14978</b>	Contrasting Leather						2,955	4,370	5,010	5,195				
		Top/seat			27										
		Bottom				27									
<b>TWO SEAT LARGE BENCH</b>															
	<b>14953</b>	16	60	30	3½	62	3,665	3,840	5,375	6,100	6,285	4,005	4,295	4,630	4,965
	Fully upholstered														
	<b>14951</b>	Contrasting Fabric					3,665					3,835	3,980	4,145	4,320
		Top/seat			1¼										
		Bottom				2									
	<b>14952</b>	Contrasting Leather						3,840	5,375	6,100	6,285				
		Top/seat			32										
		Bottom				36									
<b>THREE SEAT BENCH</b>															
	<b>14999</b>	16	72	30	4	72	4,800	5,040	6,790	7,605	7,845	5,180	5,530	5,905	6,285
	Fully upholstered														
	<b>14979</b>	Contrasting Fabric					4,800					4,995	5,165	5,350	5,545
		Top/seat			2										
		Bottom				2½									
	<b>14980</b>	Contrasting Leather						5,040	6,790	7,605	7,845				
		Top/seat			36										
		Bottom				42									
<b>OTTOMAN</b>															
	<b>14990</b>	16	30	30	2½	45	1,935	2,035	3,175	3,695	3,845	2,170	2,385	2,615	2,865
	Fully upholstered														
	<b>14961</b>	Contrasting Fabric					1,935					2,060	2,175	2,300	2,425
		Top/seat			1½										
		Bottom				1¼									
	<b>14962</b>	Contrasting Leather						2,035	3,175	3,695	3,845				
		Top/seat			24										
		Bottom				23									

Fabric to be upholstered on Kloud requires approval from Nienkamper's factory. Please contact customer service at 800 668 9318 for our fabric approval list.

# STOOLS AND BENCHES

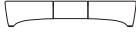
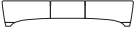
MAX™ Benches Designer - Mark Müller

Model Number	Seat H"	W"	D"	H"	Fabric Leather		— US Only —																
					Yds.	Sq.Ft.	COM	COL	Verde	Grano	Cremoso	Knoll Textiles											
							1	2	3	4													
<b>TWO SEAT BENCH</b>																							
	<b>16420</b>	17	64	25	17	3¾	60	2,940	3,080	5,180	5,765	6,005	3,300	3,625	3,970	4,340							
wood level ebonized unless specified																							
<b>TWO SEAT BENCH-WOOD RUNNER</b>																							
	<b>16421</b>	17	64	25	17	3¾	60	3,780	3,960	6,025	6,615	6,870	4,140	4,465	4,815	5,180							
<b>TWO SEAT BENCH-WOOD BASE</b>																							
	<b>16422</b>	17	64	25	17	2½	43	5,490	5,785	7,115	7,535	7,700	5,730	5,945	6,175	6,425							
<b>THREE SEAT BENCH</b>																							
	<b>16430</b>	17	87	25	17	4¾	84	3,895	4,080	7,025	7,855	8,200	4,340	4,760	5,200	5,655							
<b>THREE SEAT BENCH-WOOD RUNNER</b>																							
	<b>16431</b>	17	87	25	17	4¾	84	4,720	4,965	7,860	8,690	9,030	5,175	5,590	6,030	6,490							
<b>THREE SEAT BENCH-WOOD BASE</b>																							
	<b>16432</b>	17	87	25	17	3½	60	5,870	6,170	8,120	8,705	8,950	6,210	6,505	6,840	7,170							

Max Benches pass CAL 133 certified for an upcharge \$440 list per 2 seat bench, and \$870 list per 3 seat bench. Certification applies to Nienkämper leathers and fabrics that have a minimum of 50% natural fibre content. COM's and COL's are subject to approval. Add the extension "-CAL" to the model number when ordering.

## Max Benches

Benches are available fully upholstered (Model # 16420 and #16430), with a solid maple runner (Model # 16421 and # 16431), or with a wood veneer base (Model # 16422 and #16432). Wood runners and bases are available in standard Nienkämper veneers and stains, refer to page 12 for a listing. To match custom stains add \$600list for each stain colour.

Model #16421



Model #16421



Model #16422



Model #16422



# STOOLS AND BENCHES

Mint Designer - busk + hertzog

Model Number	Seat H"	W"	D"	H"	Fabric Yds.	Leather Sq.Ft.	COM	COL	Neather	Verde	Grano	Cremoso	— US Only —			
													Knoll Textiles			
													1	2	3	4

## MINT STOOL



<b>10780</b>	16½	26¼	23¾	16½	2	36	1,700	1,785	1,885	2,720	2,900	2,990	1,890	2,060	2,250	2,445
--------------	-----	-----	-----	-----	---	----	-------	-------	-------	-------	-------	-------	-------	-------	-------	-------

Model #10780



**Standard features:**

- Frame is constructed of FSC plywood core
- Stool with molded foam



# STOOLS AND BENCHES

Moment collection Designer - busk + hertzog

— US Only —

Model Number	W"	D"	H"	Fabric Yds	Leather Sq.Ft.	COM	COL	Verde	Grano	Cremoso	Knoll Textiles			
											1	2	3	4

## MOMENT STOOLS

19½" top	<b>26011</b>	19½ dia.	16	2	36	1,405	1,480	2,385	2,585	2,685	1,600	1,765	1,955	2,150
----------	--------------	----------	----	---	----	-------	-------	-------	-------	-------	-------	-------	-------	-------



16½" top	<b>26012</b>	16½ dia.	16	2	36	1,405	1,480	2,385	2,585	2,685	1,600	1,765	1,955	2,150
----------	--------------	----------	----	---	----	-------	-------	-------	-------	-------	-------	-------	-------	-------

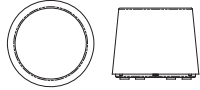

## MOMENT TABLES

19½" top	<b>26021/2</b>	19½ dia.	16	Veneer	1,820
	<b>26021/5</b>			P-Lam	1,200
	<b>26021/7</b>			Paint	1,350

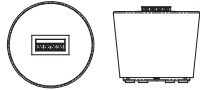

16½" top	<b>26022/2</b>	16½ dia.	16	Veneer	1,820
	<b>26022/5</b>			P-Lam	1,200
	<b>26022/7</b>			Paint	1,350



\*List price for tables doesn't include power unit.

## SIMPLE POP UP FORUM

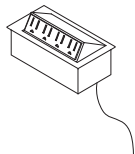

<b>8174</b>	975
(4 power pre-wired with 72" cord)	



Linking device detail

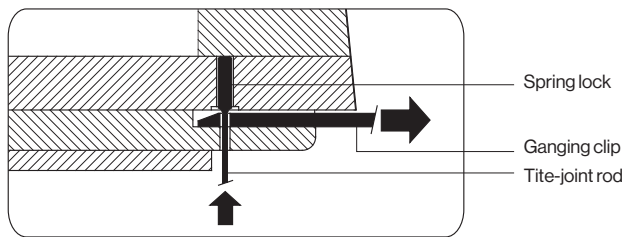

### Standard features:

- Frame is constructed of FSC Plywood core
- Stool with molded foam
- The table is available in white, silver, or black paint finish or any standard wood veneer or P-Lam.
- With glides at bottom

# STOOLS AND BENCHES

Nienkämper River Designer - busk + hertzog

— US Only —

Model Number	Seat H"	W"	D"	H"	Fabric		COM	COL	Neather	Verde	Grano	Cremoso	Knoll Textiles					
					Yds.	Sq. Ft.							1	2	3	4		
<b>NIENKÄMPER RIVER BENCH: LEFT ELEMENT</b>																		
	17	74	29	17														
			(full dimension)															
<b>11842</b>	fully upholstered				3½	63			3,635	3,820	3,960	5,420	5,750	5,910	3,965	4,270	4,600	4,935
<b>11842/1</b>	contrasting fabric body sides & Hollow				3½		1		3,635		3,960				3,965	4,270	4,600	4,935
<b>11842/2</b>	contrasting leather body sides & Hollow					63				3,820		5,420	5,750	5,910				

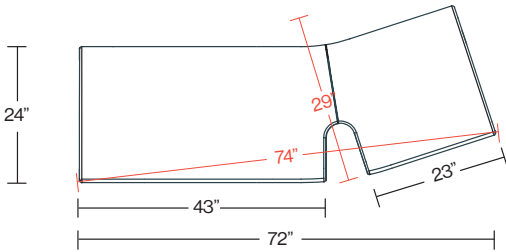

## NIENKÄMPER RIVER BENCH: RIGHT ELEMENT

	17	74	29	17														
			(full dimension)															
<b>11843</b>	fully upholstered				3½	63			3,635	3,820	3,960	5,420	5,750	5,910	3,965	4,270	4,600	4,935
<b>11843/1</b>	contrasting fabric body sides & Hollow				3½		1		3,635		3,960				3,965	4,270	4,600	4,935
<b>11843/2</b>	contrasting leather body sides & Hollow					63				3,820		5,420	5,750	5,910				

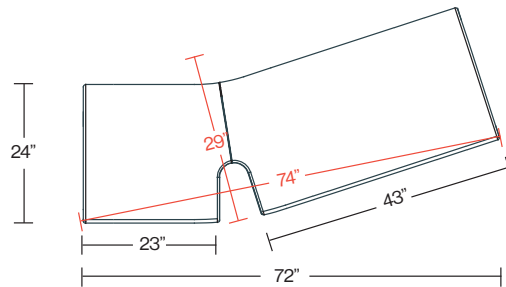

Model # 11842/1  
River left element



Model # 11843/1  
River right element



### Standard features:

- Plywood frame with soy based flexible polyurethane seat foam
- Plastic glides at the bottom
- Contrasting leather or fabric upholstery can be specified for body, sides/hollow of the River bench with no upcharge
- More options of contrasting upholstery on the body of River bench is available with upcharge, please contact nienkämper customer service at 1-800-668-9318 for details

### Optional features:

- River has optional accessories available to be installed at "Hollow" Area:
- Coat Bar or support bar of the table is in aluminum finish available in black or white as standard
- Table top is in black marine-grade plastic as standard, veneer or P-lam option is also available with upcharge
- Single power outlet and stacked USB charger with 72" cord available in black or white as standard

Two centre elements (model #11841/1), one right element (model #11843/1) with two tables (model #11863) and coat bar (model #11862)



# STOOLS AND BENCHES

Nienkämper River Designer - busk + hertzog

— US Only —

Model Number	Seat H"	W"	D"	H"	Fabric Leather		COM	COL	Neather	Verde	Grano	Cremoso	Knoll Textiles					
					Yds.	Sq.Ft.							1	2	3	4		
<b>NIENKÄMPER RIVER BENCH: CENTER ELEMENT</b>																		
	17	54	28	17														
		(full dimension)																
<b>11841</b>	fully upholstered				3	54			2,920	3,070	3,195	4,430	4,695	4,825	3,200	3,465	3,745	4,040
<b>11841/1</b>	contrasting fabric body sides & Hollow				3				2,920		3,195				3,200	3,465	3,745	4,040
<b>11841/2</b>	contrasting leather body sides & Hollow				54					3,070		4,430	4,695	4,825				
						18												

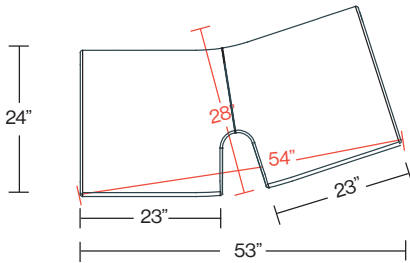

## Nienkämper River Accessories at "Hollow" area

### COAT BAR



<b>11862</b>		72		1,605
--------------	--	----	--	-------

### TABLE



<b>11863</b>	16 dia.	25½		855
--------------	---------	-----	--	-----

### POWER OUTLET



<b>11864</b>	2 dia.	2¼		285
--------------	--------	----	--	-----

### STACKED USB CHARGER



<b>11865</b>	2 dia.	2		490
--------------	--------	---	--	-----

### Standard features:

- Plywood frame with soy based flexible polyurethane seat foam
- Plastic glides at the bottom
- Contrasting leather or fabric upholstery can be specified for body, sides/ hollow of the River bench with no upcharge
- More options of contrasting upholstery on the body of River bench is available with upcharge, please contact nienkämper customer service at 1-800-668-9318 for details

### Optional features:

- River has optional accessories available to be installed at "Hollow" Area:
- Coat Bar or support bar of the table is in aluminum finish available in black or white as standard
- Table top is in black marine-grade plastic as standard, veneer or P-lam option is also available with upcharge
- Single power outlet and stacked USB charger with 72" cord available in black or white as standard

**Model # 11841**  
River centre element



**Model # 11865**  
Stacked USB charger at "Hollow" area



# STOOLS AND BENCHES

Patkau Bench Designer - Patkau Architects

Model Number	W"	D"	H"	List Price
--------------	----	----	----	------------

## PATKAU BENCH

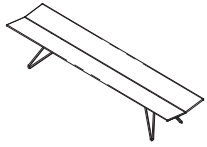

<b>10281</b>	48	21½	16½	9,360
<b>10282</b>	60	21½	16½	9,970
<b>10283</b>	72	21½	16½	10,640
<b>10284</b>	84	21½	16½	11,150
<b>10285</b>	96	21½	16½	11,665

### Standard Features

- Seat Material Options: solid oak, walnut, maple (custom solids depend on specific availability)
- Frame Material: stainless steel rod
- Seat Finish: standard Nienkämper stains & finish
- Frame Finish: brushed stainless, powder coat satin black



**Model # 10282**  
**Patkau Bench**



# STOOLS AND BENCHES

Pullman™ Benches Designer - Nienkämper

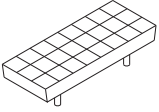
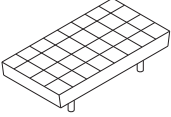
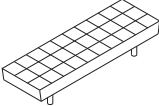
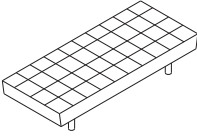
— US Only —

Model Number	Seat H"	Arm H"	W"	D"	H"	Fabric		COM	COL	Verde	Grano	Cremoso	Knoll Textiles									
						Yds.	Sq. Ft.						1	2	3	4						
<b>BENCH (3 SQUARES X 8 SQUARES)</b>																						
 <b>15712</b>	16		64	25	16	3	56		3,880	4,075	5,985	6,530	6,745	4,160	4,430	4,705	5,000					
Fully Upholstered																						
<b>BENCH (4 SQUARES X 8 SQUARES)</b>																						
 <b>15713</b>	16		64	33	16	3¼	70		4,335	4,540	6,940	7,625	7,910	4,690	5,015	5,370	5,730					
Fully Upholstered																						
<b>BENCH (3 SQUARES X 10 SQUARES)</b>																						
 <b>15703</b>	16		80	25	16	3½	65		4,440	4,655	6,875	7,520	7,760	4,775	5,070	5,400	5,735					
Fully upholstered																						
<b>BENCH (4 SQUARES X 10 SQUARES)</b>																						
 <b>15702</b>	16		80	33	16	4¾	78		5,060	5,325	7,980	8,750	9,065	5,510	5,925	6,365	6,825					
Fully upholstered																						
<b>OTTOMAN</b>																						
 <b>15708</b>	16		33	25	16	1¼	33		2,595	2,720	3,820	4,145	4,280	2,770	2,915	3,080	3,250					
Fully upholstered																						
<b>BOLSTER</b>																						
 <b>15705</b>	6 dia.		23			¾	8		405	430	715	790	825	480	540	615	690					
Fully upholstered																						

**Pullman Bench**

Fabric yardages are based on 54" width with no repeat, fabric must be railroaded, see Page 6 for instructions. The base is available in a brushed nickel finish as standard; add 5% for a polished chrome finish.

**Model #15703**  
Pullman bench







**Model #15712**  
Pullman bench

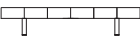

# STOOLS AND BENCHES

Six® Collection Designer - Nienkämper

— US Only —





Model Number	Seat H"	W"	D"	H"	Fabric Yds.	Leather Sq. Ft.	COM	COL	Neather	Verde	Grano	Cremoso	Knoll Textiles				
													1	2	3	4	
<b>2 SEAT BENCH</b>																	
 <b>30303</b>	17	63	31½	3	54	4,250	4,410	4,515	5,920	6,355	6,535	4,535	4,795	5,075	5,370		
<b>3 SEAT BENCH</b>																	
 <b>30304</b>	17	82	31½	4½	81	4,760	4,955	5,165	7,265	7,920	8,185	5,180	5,575	5,995	6,430		
<b>OTTOMAN</b>																	
 <b>30305</b>	17	28	27¾	1½	27	2,835	2,950	2,980	3,685	3,900	3,980	2,980	3,115	3,255	3,400		
<b>OTTOMAN ON PEDESTALS</b>																	
 <b>30310</b>	17	28	27¾	1½	27	2,125	2,235	2,260	2,960	3,175	3,265	2,260	2,390	2,535	2,685		
<b>2 SEAT BENCH ON PEDESTALS</b>																	
 <b>30308</b>	17	63	31½	3	54	3,525	3,695	3,805	5,200	5,640	5,815	3,815	4,070	4,355	4,650		
<b>3 SEAT BENCH ON PEDESTALS</b>																	
 <b>30309</b>	17	82	31½	4½	81	4,040	4,240	4,450	6,540	7,195	7,455	4,465	4,855	5,275	5,715		

Six Bench passes CAL 133 certified for an upcharge of \$635 per 2 seat bench, \$830 per 3 seat bench and \$360 per ottoman. Certification applies to Nienkämper leathers and fabrics that have a minimum of 50% natural fibre content. COM's and COL's are subject to approval. Add the extension "-CAL" to the model number when ordering.

# STOOLS AND BENCHES

Spin Stool/Tables Designer - patty johnson

— US Only —

Model Number	Seat H"	W"	D"	H"	Fabric Yds.	Leather Sq.Ft.	COM	COL	Neather	Verde	Grano	Cremoso	Knoll Textiles				
													1	2	3	4	
<b>SIDE TABLE/STOOL</b>																	
	<b>31901</b>	12½		19¼			2,020										
	with Cushion																
	<b>31901C</b>				½	4	2,075	2,110	2,125	2,190	2,230	2,240	2,135	2,170	2,225	2,265	
	<b>31902</b>	13½		13			1,750										
	with Cushion																
	<b>31902C</b>				½	4	1,815	1,845	1,855	1,925	1,955	1,970	1,860	1,910	1,955	2,005	
	<b>31904</b>	22		19¼			3,610										
	with Cushion																
	<b>31904C</b>				1	10	3,675	3,700	3,770	3,940	4,040	4,060	3,770	3,855	3,950	4,050	
<b>COFFEE TABLE/STOOL</b>																	
	<b>31903</b>	24		10			2,140										
	with Cushion																
	<b>31903C</b>				1	10	2,195	2,235	2,295	2,475	2,565	2,595	2,295	2,380	2,480	2,575	

Model #31903 & Model #31902 with black finish





Spin tables and stools are available in a clear or black, anodized finish specify at time of order.

Spin Tables/Stools are spun aluminum with a removable lid for storage capacity inside.

# STOOLS AND BENCHES

Wavelength<sup>®</sup> Benches Designer - karim rashid

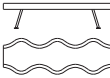
— US Only —

Model Number	Seat H"	W"	D"	H"	Fabric						Knoll Textiles					
					Yds.	Sq.Ft.	COM	COL	Verde	Grano	Cremoso	1	2	3	4	
<b>TWO SEAT BENCH</b>																
	1404_	16¾	47¼	23½	16¾											
	(Model #1)	Fully Upholstered				1½	24	3,950	4,145	4,845	5,090	5,180	4,095	4,230	4,370	4,510
	(Model #2)	Fabric seat, fabric contrasting trim				¾	1½	3,950					4,030	4,090	4,160	4,240
	(Model #3)	Leather seat, leather contrasting trim				12	24		4,145	4,845	5,090	5,180				
	(Model #4)	Fully Upholstered, rounded ends				1¾	28	3,950	4,145	4,845	5,090	5,180	4,125	4,270	4,440	4,605
	(Model #5)	Fabric seat, fabric contrasting trim, rounded ends				1½	1¾	3,950					4,095	4,230	4,370	4,510
(Model #6)	Leather seat, leather contrasting trim, rounded ends				24	28		4,145	4,845	5,090	5,180					
<b>THREE SEAT BENCH</b>																
	1405_	16¾	70 7/8	23½	16¾											
	(Model #1)	Fully Upholstered				2¼	36	4,370	4,585	5,595	5,920	6,065	4,585	4,780	4,990	5,210
	(Model #2)	Fabric seat, fabric contrasting trim				2¼	2¼	4,370					4,585	4,780	4,990	5,210
	(Model #3)	Leather seat, leather contrasting trim				36	36		4,585	4,845	5,090	5,180				
	(Model #4)	Fully Upholstered, rounded ends				2½	40	4,370	4,585	5,595	5,920	6,065	4,605	4,820	5,055	5,295
	(Model #5)	Fabric seat, fabric contrasting trim, rounded ends				2	2¼	4,370					4,565	4,725	4,915	5,110
(Model #6)	Leather seat, leather contrasting trim, rounded ends				32	36		4,585	5,595	5,920	6,065					
<b>OTTOMAN</b>																
	1406_	16¾	23¾	23½	16¾											
	(Model #1)	Fully Upholstered				1	16	3,165	3,340	3,585	3,690	3,725	3,265	3,345	3,445	3,540
	(Model #2)	Fabric seat, fabric contrasting trim				¾	½	3,165					3,240	3,300	3,375	3,450
(Model #3)	Leather seat, leather contrasting trim				12	8		3,340	3,585	3,690	3,725					

Wavelength Bench passes CAL 133 certified for an upcharge of \$505 list per 2 seat bench, \$760 list per 3 seat bench, \$380 list per ottoman. Certification applies to Nienkämper leathers and fabrics that have a minimum of 50% natural fibre content. COM's and COL's are subject to approval. Add the extension "-CAL" to the model number when ordering.

Fabric direction when railroaded

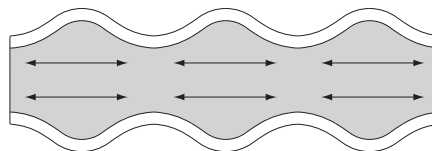

### Wavelength Benches:

- Fabric yardages are based on plain fabrics with no apparent pattern direction. Fabric is railroaded.
- When upholstering in two different fabrics or leathers use the COM price or COL price and ship yardages or square footage as noted on page 6. Most fabrics and vinyl are suitable for the top seat portion but the contrasting trim must have stretch.
- Nienkämper reserves the right to determine the suitability of COM on our furniture. For further details regarding approvals, refer to page 6.
- specify polished or brushed aluminum frame.

Fabric to be upholstered on Wavelength requires approval from Nienkämper's factory. Please contact customer service at 800 668 9318 for our fabric approval list.

**Model #14041**  
Cast aluminum frame in polished aluminum



**Model #14044**  
Two seat bench, polished aluminum frame





**Model #14044**  
Two seat bench, rounded ends polished aluminum frame



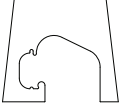
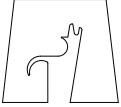
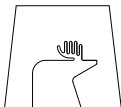

# STOOLS AND BENCHES

ZooStool Designer - Mouna & silvio russo

	Model Number	W"	D"	H"	List Price
<b>BISON STOOL</b>					
	20912	11	11	13¼	900
<b>CAT STOOL</b>					
	20911	11	11	13¼	900
<b>DEER STOOL</b>					
	20914	11	11	13¼	900
<b>MAPLE LEAF STOOL</b>					
	20915	11	11	13¼	900
<b>SEAL STOOL</b>					
	20913	11	11	13¼	900

Stackable Zoo Stools are constructed from FSC plywood core with laminate in bold primary colours:

Cat: yellow (Arborite Daffodil S480-CA)

Bison: blue (Abet 482SEI)

Seal: green (Abet 460SEI)

Deer: orange (Pionite bittersweet S0312)

Maple Leaf: red (Wilsonart Holly Berry D307-60)

Note: Custom colours and logos available for quantities of 4+

# nienkämper

International Inc.

## MEETING PODS



# MEETING PODS

Patkau Cocoon Designer - Patkau Architects

Model Number	W"	D"	H"	Fabric Leather		COM	COL	Verde	Grano	Cremoso	— US Only —			
				Yds.	Sq. Ft.						KnollTextiles			
											1	2	3	4

## PATKAU COCOON

<b>10280</b>	101½	105	104	4	130	67,810	70,290	74,005	75,180	75,780	68,915	70,005	71,215	72,410
--------------	------	-----	-----	---	-----	--------	--------	--------	--------	--------	--------	--------	--------	--------

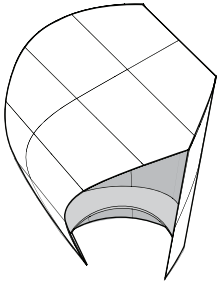

### Standard features:

- Seat Upholstery: Leather and KnollTextiles
- Exterior Panel Finish: birch plywood natural finish
- Lighting: 12V pot lights (105 Lumen ea.) x 5 / motion detection switch.
- Power options mounted under seat



2 power, 1 USB charger



Dual USB charger

### Model #10280



# MEETING PODS

Patkau Ice Hut Designer - Patkau Architects

Model Number	W"	D"	H"	Fabric Leather		COM	COL	Verde	Grano	Cremoso	— US Only —			
				Yds.	Sq.Ft.						KnollTextiles			
											1	2	3	4

## PATKAU ICE HUT

<b>21000</b>	60	60	96	9	162	49,810	52,310	61,655	62,820	63,990	51,000	52,190	53,490	54,820
--------------	----	----	----	---	-----	--------	--------	--------	--------	--------	--------	--------	--------	--------



Model # 21000

