

# Vox<sup>®</sup> FlipTop<sup>™</sup>

Mark Muller



**nienkämper**  
International Inc.

Prices include freight charges, blanket wrapped, dock delivered, from the manufacturing source to any location in the contiguous United States. Packing and/or crating are available, if required, upcharges apply.

## TABLE OF CONTENTS

---

<b>Wood Veneer/Finishes</b>	<b>4</b>
<b>Wood Grain Plastic Laminate Surfaces</b>	<b>5</b>
<b>Coloured Plastic Laminate Surfaces</b>	<b>6</b>
<b>Fingerprint Resistance Plastic Laminate Surfaces</b>	<b>7</b>
<b>Base &amp; Storage Information</b>	<b>8</b>
<b>Modesty Panel Photographs</b>	<b>9</b>
<b>Forum Information</b>	<b>10</b>
<b>Cabling Photography</b>	<b>11</b>
<b>Meeting Tables Photography</b>	<b>12</b>
<b>Vox® FlipTop™ Meeting Tables with Flush Legs</b>	<b>13-19</b>
Tables for Meeting Room Applications	14-16
Meeting Room Layouts	17-19
<b>Vox® FlipTop™ Meeting Tables with Inset Legs</b>	<b>20-27</b>
Planning with FlipTop™ Tables	21
Tables for Meeting Room Applications	22-24
Meeting Room Layouts	25-27
<b>Vox® FlipTop™ Conference Tables</b>	<b>28-35</b>
Edge Details	29
Forum Information	30
Tables for Meeting Room Applications	31-33
Conference Room Layouts	34-35
<b>Terms and Conditions of Sale</b>	<b>36</b>

# VENEERS

All wood surfaces are protected with a durable polyurethane clear laquer which includes UV inhibitor. This finish is known for its exceptional durability, as well as abrasion, chemical, impact and scratch resistance. Standard sheen level is 45 degrees. Optional 5, 10 and 35 degree sheen levels are available on request at no additional cost.

Wood Species	Order Code	Veneer/Stain	Upcharge
Maple	F-01	Natural Maple	No upcharge applies.
	F-02	Natural Curly Maple - Rotary Cut	Add 15%.
	F-03	Natural Bird's Eye Maple - Rotary Cut	Call Customer Service for pricing.
	F-04	Maple Stained Pear	No upcharge applies.
Cherry	F-05	Natural Cherry	No upcharge applies.
	F-06	Standard Cherry	No upcharge applies.
	F-07	Cherry Stained Amber	No upcharge applies.
	F-08	Cherry Stained Auburn	No upcharge applies.
	F-09	Cherry Stained Burgundy	No upcharge applies.
Mahogany	F-10	Light Mahogany	No upcharge applies.
	F-11	Medium Mahogany	No upcharge applies.
	F-12	Dark Mahogany	No upcharge applies.
	F-13	Red Mahogany	No upcharge applies.
Anagre	F-14	Natural Figured Anagre - Qtr. Cut Book-Match	Add 15%.
	F-15	Figured Anagre Stained Amber - Qtr. Cut Book-Match	Add 15%.
Sycamore	F-16	Natural Figured Sycamore - Qtr. Cut Book-Match	Add 15%.
Walnut	F-17	Burnt Walnut	No upcharge applies.
	F-19	Natural Walnut	No upcharge applies.
	F-24	Carbon Grey Walnut	No upcharge applies.
	F-27	Creamy Walnut	No upcharge applies.
	F-28	Tawny Walnut	No upcharge applies.
White Oak	F-18F	Natural White Oak - Flat Cut Book-Match (10° sheen)	No upcharge applies.
	F-18R	Natural White Oak - Rift Cut Slip-Match (10° sheen)	Add 5%
	F-26	Charcoal Ash On Oak - Flat Cut Book-Match (10° sheen)	No upcharge applies.
	F-29	Smokey Oak - Rift Cut Slip-Match (10° sheen)	Add 5%
Sapele – Ribbon Stripe	F-20	Natural Ribbon Strip Sepele - Qtr. Cut Slip-Match	No upcharge applies.
Moabe (Cherry substitute)	F-21	Natural Moabe - Quarter - Qtr. Cut Book-Match	No upcharge applies.
Cape Coast Walnut	F-22	Dark Cape Coast Walnut - Qtr. Cut Slip-Match	No upcharge applies.
	F-23	Natural Cape Coast Walnut - Qtr. Cut Slip-Match	No upcharge applies.
Ash	F-25	Slate Grey Ash - Qtr. Cut Slip-Match	No upcharge applies.

## VENEER GRAIN OPTIONS

Nienkämper products utilize the best quality veneers available, and, combined with Nienkämper's patented veneering systems, create work environments of incredible quality and beauty.

All veneer furniture comes standard with flat cut book-match veneer; flat cut slip-match veneer can also be specified. Quarter cut slip-match and quarter cut book-match veneers are available at a 5% upcharge. Figured Anagre and Figured Sycamore veneers are Quarter cut book-matched. Bird's Eye Maple and Curly Maple are rotary cut.

Self and Taper edge tops with veneer are manufactured with a solid wood edge. All edges are then veneer wrapped to create a seamless profile top.

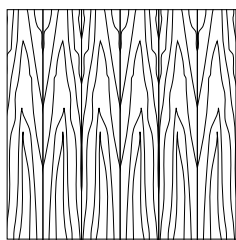

Standard Flat Cut Book-Match V1

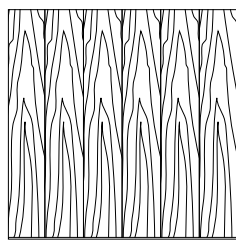

Flat Cut Slip-Match V2

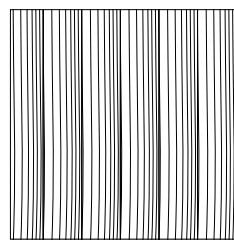

Quarter Cut Slip-Match V3  
Add 5%

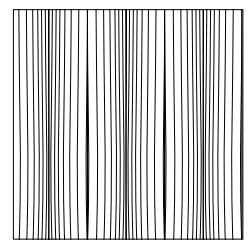

Quarter Cut Book-Match V4  
Add 5%

## P-LAM

### Wood grain plastic laminate surfaces are available on table tops with Facet and Taper edges.

These tops are manufactured with a solid wood edge that is applied prior to the laminate top surface. This method conceals the thickness of the wood edge, while providing the durability required. Wood edges are selected that most closely resemble both the species and the color of the laminate chosen

Nienkämper has pre-selected a number of standard wood grain plastic laminates that represent a cross section of both color and species. Simply include the order code with the model number to make these selections. Alternatively wood grain plastic laminates selected outside of Nienkämper's standard selection can be made by specifying the manufacturer as well as the description and model number of the laminate at the time of order.

Wood Grain Plastic Laminate Surfaces	Order Code	Manufacturer #	Finish
Champagne Sagawood	WL1	Nevamar WM8349T	Textured
Hardrock Maple	WL2	Pionite WM791-SD	Textured/Suede
Amber Curly Maple	WL3	Pionite WM221-SD	Textured/Suede
Anagre	WL4	Pionite WX041	Suede
Monticello Maple	WL5	Wilsonart 7925-38	Fine Velvet Texture
Millwork Cherry	WL7	Pionite WC431	PV-Polished Velvet
Huntington Maple	WL9	Wilsonart 7929-38	Fine Velvet Texture
Wild Cherry	WL10	Formica 5904.43	Artisan
Amber Cherry	WL11	Wilsonart 7919.38	Fine Velvet Texture
Figured Mahogany	WL12	Wilsonart 7040-60	Matte
Fusion Maple	WL13	Wilsonart 7909-78	Fine Grain
New Age Oak	WL14	Wilsonart 7938-78	Fine Grain
Natural Pear	WL15	Wilsonart 7061-78	Fine Grain
Tuscan Walnut	WL16	Wilsonart 7921-78	Fine Grain
Nepal Teak	WL17	Wilsonart 7209-78	Fine Grain
Wild Cherry	WL18	Wilsonart 7054-78	Fine Grain
River Cherry	WL19	Wilsonart 7937-78	Fine Grain
Montana Walnut	WL20	Wilsonart 7110-78	Fine Grain
Windsor Mahogany	WL22	Wilsonart 7039-78	Fine Grain
Williamsburg Cherry	WL23	Wilsonart 7936-78	Fine Grain
Florence Walnut	WL25	Wilsonart 7993-78	Fine Grain
Skyline Walnut	WL26	Wilsonart 7964K-12	Soft Grain
Sterling Ash	WL27	Wilsonart 7995-78	Fine Grain
Ginger Root Maple	WL28	Formica 7288-58	Matt

To specify the wood grain laminate required simply add the Order Code WL\_ to the model number of the product.

Wood grain laminate samples are available from your local sales representative or by calling Nienkämper's customer service department at 1-800-668-9318.

# P-LAM

## COLOURED P-LAM

Both Taper and Facet edge profiles are available with a colored laminate top.

**Laminate edging on Taper tops.** Edging will match the top surface and is applied prior to the surface laminate. By applying the laminate in this way the seam is positioned horizontally, is much less conspicuous as well as more durable.

**Wood edging** on Facet and Taper Edge tops is applied prior to the laminate. By applying the wood edge in this way the thickness of the wood edge is concealed, while providing the durability required. Wood species and finishes for edging, can be selected from page 4.

For laminates specified outside of Nienkämper's standard selection, specify the manufacturer as well as the description and model number of the laminate selected at time of order. For Facet edge tops, the laminate must be a post forming grade.

**Translucent edging** on Taper edge tops is applied after the surface laminate. The translucent edge is very durable. Clear translucent edge provides a good match with most white colored laminates, while silver translucent edge provides a metallic look and contrast to colored plastic laminates.



Taper edge in clear translucent with white P-Lam top

Coloured Plastic Laminates Surface	Order Code	Manufacturer #	Finish
Grey (Nienkamper - Light Grey/Putty)	CL-01	Wilsonart 1500-60	Matte
Platinum Gray (Nienkamper - Medium Grey/Clay)	CL-02	Nevamar S6023T	Textured
Slate Grey (Nienkamper - Dark Grey)	CL-03	Wilsonart D91-60	Matte
Black	CL-04	Wilsonart 1595-60	Matte
Angel White	CL-05	Pionite SW-826SD	Textured/Suede
Frosty White	CL-06	Wilsonart 1573-60	Matte
White (for writable surface)	CL-07	Formica 949-90	Gloss



Add the order code behind the edge profile when specifying.

# P-LAM

---

## FINGERPRINT RESISTANCE P-LAM

Fingerprint Resistance Plastic Laminate is an innovative material created for interior design applications and is suitable for both vertical and horizontal interior applications on our nienkamper furniture.

The external surface of Fingerprint Resistance Plastic Laminate involves the use of nanotechnology made possible by next generation acrylic resins.

The unique composition offers extraordinary features coupled with a unique user experience. These include an ultra matte surface (eliminating glare), an ultra sofa feel, an anti-fingerprint surface, thermal healing of micro-scratches, increased durability as well as anti-bacterial and mold-resistant properties.

**Edgeband** with matching color to the Fingerprint Resistance Plastic Laminate is only available on taper edge. For 1" or 1-1/4" thick top with self edge, same Fingerprint Resistance Plastic Laminate can be specified for the self edge or it can be in clear/silver translucent edge.

There is a 10% upcharge on our standard plastic laminate table pricing for Fingerprint Resistance Plastic Laminate.

Colored "Fingerprint Resistance" Plastic Laminate Surface	Order Code	Finish
Black	RL-01	Matte
Gray	RL-02	Matte
Pure White	RL-03	Matte
Sand	RL-04	Matte
Bronze	RL-05	Matte

Edgeband to Match with Colored "Fingerprint Resistance" Plastic Laminate	Order Code
Black	RE-01
Gray	RE-02
Pure White	RE-03
Sand	RE-04
Bronze	RE-05

# VOX® FLIPTOP™ MEETING TABLES

## BASE AND STORAGE INFORMATION DESIGN - MARK MÜLLER

**Vox® FlipTop™ Base Design** - This versatile design allows the top of the table to rotate into a vertical position for storage.

Each leg is independently locked at the top of the leg with a small catch. Moving the catch to one side locks or unlocks the base from the top. A small colored mark indicates the catch is in an unlocked position.

Low profile plastic casters are individually locked by depressing with the tip of a foot.

Hollow leg assemblies house gas cylinders that provide a neutral balance to the top. A stabilizer rail runs between the leg assemblies providing both structure and wire management.

**Flush Legs** - This option (pages 13-19) allows multiple tables to be joined together while maximizing knee space to the users. Seams between tables are never used as work areas.

**Inset Legs** - This option (pages 20-27) maximizes the number of users allowing seating at the end of tables

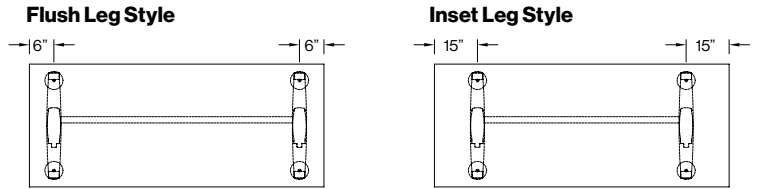

Description

Base Width "

### Standard Vox FlipTop T-Base

24" Base for 24" deep tops  
26" Base for 30" & 36" deep tops

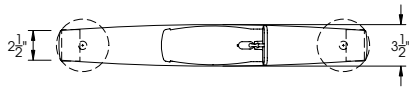

PLAN VIEW

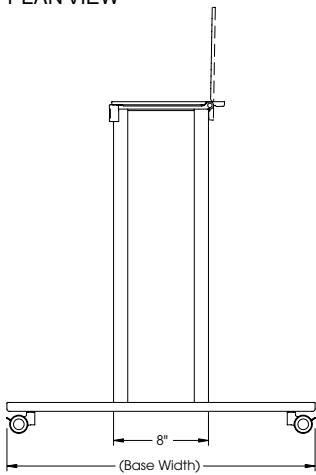

END ELEVATION

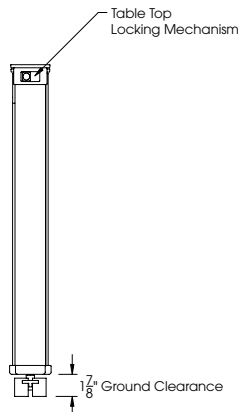

FRONT ELEVATION



Flush leg shown

### Storage Requirements

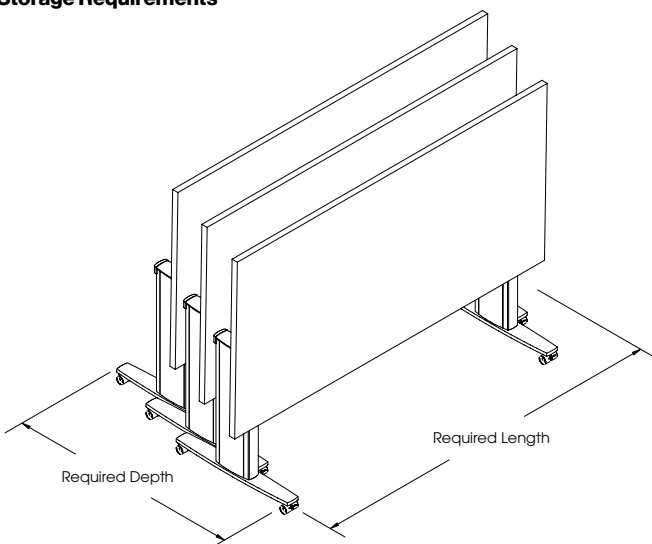

Table Length	Floor Space Required When Nested (L' x D')		
	4 Tables	8 Tables	12 Tables
<b>For 24" to 27" Deep Tops</b>			
60	72x55	87x96	102x137
66	78x55	93x96	108x137
72	84x55	99x96	114x137
78	90x55	105x96	120x137
84	96x55	111x96	126x137
90	102x55	117x96	132x137
<b>For 30" to 36" Deep Tops</b>			
60	72x57	87x98	102x139
66	78x57	93x98	108x139
72	84x57	99x98	114x139
78	90x57	105x98	120x139
84	96x57	111x98	126x139
90	102x57	117x98	132x139



## VOX® FLIPTOP™ MODESTY PANELS

Photography Design – Mark Müller

Vox® FlipTop tables can be specified with modesty panels. Standard options include veneer to match the top, laminate with translucent edging to match the top, or anodized-aluminum.

A unique flexible hinge joins the modesty panel to the tabletop. When the top is flipped up, the panel aligns with the top and swivels out of the way.



Tables shown with natural cherry veneer and aluminum modesty panels



Table and modesty panel shown in rift cut walnut



Table and modesty panel shown in wood grain laminate WL-1

# FORUM INFORMATION

DESIGN - MARK MÜLLER

Vox® FlipTop™ tables can be specified with optional Vox® Forums. Pre-wired “S-Series” Forums as well as “T-Series” Forums are available.

“T-Series” Forums have an added benefit of removing voice/data/power cords directly from the Forum, to be connected when required. This feature also gives the user the option of specifying longer cables when needed.

“S-Series” Forums offer a broad range of pre-wired connections in a slightly larger format than T-Series Forums.

A rail joining the two table legs acts as a stabilizer for the table and along with wire management clips provide a convenient place to store cables. For complete Vox® Forum details refer to the Vox® Conference Price List

FlipTop Tables  
(1" top thickness)

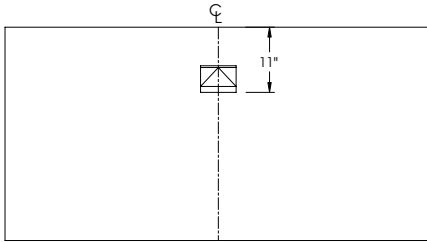

Rectangular Shape

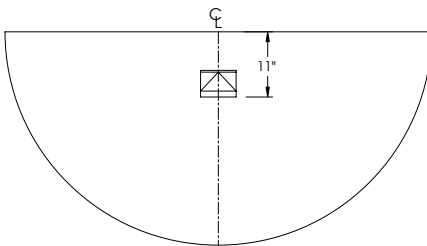

Half-Round Shape

“T” Series Forum

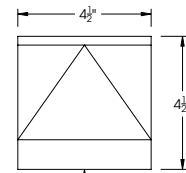

Models TR-A and TR-B

“T” Series Forum

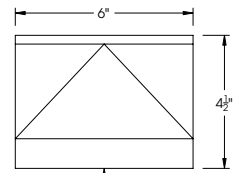

Models TR-C and TR-D

“S” Series Forum

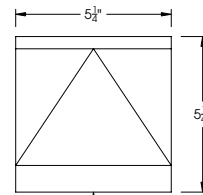

Models A,B,C,G and H

“S” Series Vox® Forums



The “S-Series” Forum is available in 2 sizes: 5 1/4” W or 12” W. Fourteen models from A to I with eight data configurations to satisfy most requirements.

“T” Series Vox® Meeting Forums



The “T-Series” Forum is available in 2 sizes 4 1/2” long and 6” long. Power, voice, and data cables can be detached from this Forum for ease of reconfiguring multiple tables or for applying longer cords.

## VOX® FLIPTOP™ CABLING

Photography Design – Mark Müller



When Vox® FlipTop tables include Vox® Forums, cables are routed along the length of the aluminum rail and held in place with plastic wire management clips provided.

This method allows cabling to be located to either side of the table, and connect to the most convenient outlet.

When tables are not in use the same cabling can be easily stowed along the rail with the wire management clips.

Once cables have been located to either leg they can be discretely routed to the floor inside a wire chase that runs up the center of the interior of each leg. A continuous flexible rubber strip holds the cables in place terminating at the base of the leg with a slot that allows the cables to exit the leg.

# VOX® FLIPTOP™ MEETING TABLES

Photography Design – Mark Müller



**VOX® FLIPTOP™ MEETING TABLES  
WITH FLUSH LEGS**

# VOX® FLIPTOP™ MEETING TABLE

## Flush Legs

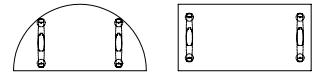

On this page:

Wood veneer tables are standard with a 1/8" solid wood edge that has a slight radius.

P-lam tables are standard with a 1/8" translucent edging that has a slight radius.

Anodized Finish

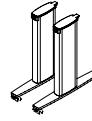

Mirror-polished

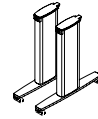

Tops are 1" Thick

### RECTANGLE TABLES

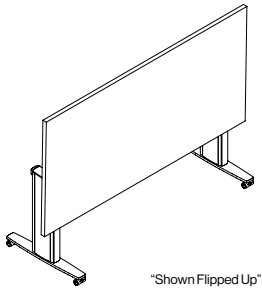
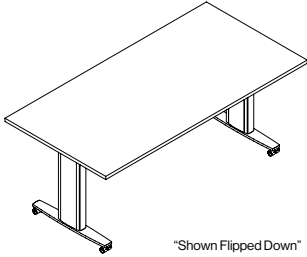

L" x D" x H"	Top Finish	Model Number	2 T-Bases	List Price	Model Number	2 T-Bases	List Price
60 24 29	Wood	56111/2	(2-24")	4,980	56101/2	(2-24")	5,560
<b>60 24 29</b>	<b>P-Lam</b>	<b>56112/5</b>	<b>(2-24")</b>	<b>4,745</b>	<b>56102/5</b>	<b>(2-24")</b>	<b>5,325</b>
66 24 29	Wood	56113/2	(2-24")	5,095	56103/2	(2-24")	5,670
<b>66 24 29</b>	<b>P-Lam</b>	<b>56114/5</b>	<b>(2-24")</b>	<b>4,840</b>	<b>56104/5</b>	<b>(2-24")</b>	<b>5,420</b>
72 24 29	Wood	56115/2	(2-24")	5,245	56105/2	(2-24")	5,815
<b>72 24 29</b>	<b>P-Lam</b>	<b>56116/5</b>	<b>(2-24")</b>	<b>4,965</b>	<b>56106/5</b>	<b>(2-24")</b>	<b>5,540</b>
78 24 29	Wood	56117/2	(2-24")	5,355	56107/2	(2-24")	5,930
<b>78 24 29</b>	<b>P-Lam</b>	<b>56118/5</b>	<b>(2-24")</b>	<b>5,055</b>	<b>56108/5</b>	<b>(2-24")</b>	<b>5,625</b>
84 24 29	Wood	56119/2	(2-24")	5,475	56109/2	(2-24")	6,040
<b>84 24 29</b>	<b>P-Lam</b>	<b>56120/5</b>	<b>(2-24")</b>	<b>5,145</b>	<b>56110/5</b>	<b>(2-24")</b>	<b>5,720</b>
90 24 29	Wood	56182/2	(2-24")	5,580	56180/2	(2-24")	6,165
<b>90 24 29</b>	<b>P-Lam</b>	<b>56183/5</b>	<b>(2-24")</b>	<b>5,235</b>	<b>56181/5</b>	<b>(2-24")</b>	<b>5,810</b>
60 30 29	Wood	56131/2	(2-26")	5,305	56121/2	(2-26")	5,895
<b>60 30 29</b>	<b>P-Lam</b>	<b>56132/5</b>	<b>(2-26")</b>	<b>5,005</b>	<b>56122/5</b>	<b>(2-26")</b>	<b>5,580</b>
66 30 29	Wood	56133/2	(2-26")	5,430	56123/2	(2-26")	6,015
<b>66 30 29</b>	<b>P-Lam</b>	<b>56134/5</b>	<b>(2-26")</b>	<b>5,105</b>	<b>56124/5</b>	<b>(2-26")</b>	<b>5,700</b>
72 30 29	Wood	56135/2	(2-26")	5,620	56125/2	(2-26")	6,205
<b>72 30 29</b>	<b>P-Lam</b>	<b>56136/5</b>	<b>(2-26")</b>	<b>5,270</b>	<b>56126/5</b>	<b>(2-26")</b>	<b>5,855</b>
78 30 29	Wood	56137/2	(2-26")	5,765	56127/2	(2-26")	6,345
<b>78 30 29</b>	<b>P-Lam</b>	<b>56138/5</b>	<b>(2-26")</b>	<b>5,385</b>	<b>56128/5</b>	<b>(2-26")</b>	<b>5,970</b>
84 30 29	Wood	56139/2	(2-26")	5,890	56129/2	(2-26")	6,465
<b>84 30 29</b>	<b>P-Lam</b>	<b>56140/5</b>	<b>(2-26")</b>	<b>5,475</b>	<b>56130/5</b>	<b>(2-26")</b>	<b>6,040</b>
90 30 29	Wood	56186/2	(2-26")	5,995	56184/2	(2-26")	6,565
<b>90 30 29</b>	<b>P-Lam</b>	<b>56187/5</b>	<b>(2-26")</b>	<b>5,560</b>	<b>56185/5</b>	<b>(2-26")</b>	<b>6,135</b>
60 36 29	Wood	56151/2	(2-26")	5,625	56141/2	(2-26")	6,210
<b>60 36 29</b>	<b>P-Lam</b>	<b>56152/5</b>	<b>(2-26")</b>	<b>5,265</b>	<b>56142/5</b>	<b>(2-26")</b>	<b>5,835</b>
66 36 29	Wood	56153/2	(2-26")	5,785	56143/2	(2-26")	6,355
<b>66 36 29</b>	<b>P-Lam</b>	<b>56154/5</b>	<b>(2-26")</b>	<b>5,375</b>	<b>56144/5</b>	<b>(2-26")</b>	<b>5,955</b>
72 36 29	Wood	56155/2	(2-26")	6,005	56145/2	(2-26")	6,580
<b>72 36 29</b>	<b>P-Lam</b>	<b>56156/5</b>	<b>(2-26")</b>	<b>5,580</b>	<b>56146/5</b>	<b>(2-26")</b>	<b>6,165</b>
78 36 29	Wood	56157/2	(2-26")	6,185	56147/2	(2-26")	6,755
<b>78 36 29</b>	<b>P-Lam</b>	<b>56158/5</b>	<b>(2-26")</b>	<b>5,720</b>	<b>56148/5</b>	<b>(2-26")</b>	<b>6,300</b>
84 36 29	Wood	56159/2	(2-26")	6,285	56149/2	(2-26")	6,875
<b>84 36 29</b>	<b>P-Lam</b>	<b>56160/5</b>	<b>(2-26")</b>	<b>5,795</b>	<b>56150/5</b>	<b>(2-26")</b>	<b>6,370</b>
90 36 29	Wood	56190/2	(2-26")	6,390	56188/2	(2-26")	6,970
<b>90 36 29</b>	<b>P-Lam</b>	<b>56191/5</b>	<b>(2-26")</b>	<b>5,895</b>	<b>56189/5</b>	<b>(2-26")</b>	<b>6,475</b>
30 60 29	Wood	56171/2	(2-24")	5,305	56161/2	(2-24")	5,895
<b>30 60 29</b>	<b>P-Lam</b>	<b>56172/5</b>	<b>(2-24")</b>	<b>5,005</b>	<b>56162/5</b>	<b>(2-24")</b>	<b>5,580</b>
36 72 29	Wood	56173/2	(2-26")	5,620	56163/2	(2-26")	6,205
<b>36 72 29</b>	<b>P-Lam</b>	<b>56174/5</b>	<b>(2-26")</b>	<b>5,270</b>	<b>56164/5</b>	<b>(2-26")</b>	<b>5,855</b>

### HALF-ROUND TABLES

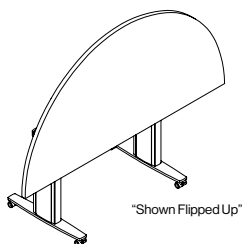
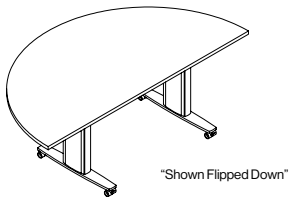

# VOX® FLIPTOP™ MEETING TABLE

## Flush Legs With Wood or P-Lam Modesty Panel



On this page:

Wood veneer tables are standard with a 1/8" solid wood edge that has a slight radius and a with wood veneer modesty panel that is self edged

P-lam tables are standard with a 1/8" translucent edging that has a slight radius and a plastic laminate modesty panel with translucent edging to match the top

Anodized Finish

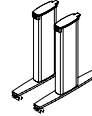

Mirror-polished

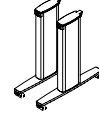

Tops are 1" Thick

### RECTANGLE TABLES

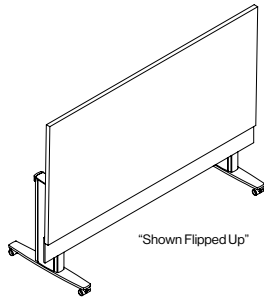
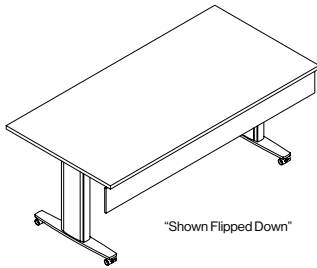

L" x D" x H"	Top Finish	Model Number	2 T-Bases	List Price	Model Number	2 T-Bases	List Price
60 24 29	Wood	56111/2P	(2-24")	5,855	56101/2P	(2-24")	6,440
<b>60 24 29</b>	<b>P-Lam</b>	<b>56112/5P</b>	<b>(2-24")</b>	<b>5,540</b>	<b>56102/5P</b>	<b>(2-24")</b>	<b>6,120</b>
66 24 29	Wood	56113/2P	(2-24")	5,975	56103/2P	(2-24")	6,550
<b>66 24 29</b>	<b>P-Lam</b>	<b>56114/5P</b>	<b>(2-24")</b>	<b>5,650</b>	<b>56104/5P</b>	<b>(2-24")</b>	<b>6,225</b>
72 24 29	Wood	56115/2P	(2-24")	6,125	56105/2P	(2-24")	6,710
<b>72 24 29</b>	<b>P-Lam</b>	<b>56116/5P</b>	<b>(2-24")</b>	<b>5,785</b>	<b>56106/5P</b>	<b>(2-24")</b>	<b>6,355</b>
78 24 29	Wood	56117/2P	(2-24")	6,270	56107/2P	(2-24")	6,860
<b>78 24 29</b>	<b>P-Lam</b>	<b>56118/5P</b>	<b>(2-24")</b>	<b>5,890</b>	<b>56108/5P</b>	<b>(2-24")</b>	<b>6,465</b>
84 24 29	Wood	56119/2P	(2-24")	6,380	56109/2P	(2-24")	6,950
<b>84 24 29</b>	<b>P-Lam</b>	<b>56120/5P</b>	<b>(2-24")</b>	<b>5,975</b>	<b>56110/5P</b>	<b>(2-24")</b>	<b>6,550</b>
90 24 29	Wood	56182/2P	(2-24")	6,500	56180/2P	(2-24")	7,100
<b>90 24 29</b>	<b>P-Lam</b>	<b>56183/5P</b>	<b>(2-24")</b>	<b>6,080</b>	<b>56181/5P</b>	<b>(2-24")</b>	<b>6,665</b>
60 30 29	Wood	56131/2P	(2-26")	6,175	56121/2P	(2-26")	6,750
<b>60 30 29</b>	<b>P-Lam</b>	<b>56132/5P</b>	<b>(2-26")</b>	<b>5,800</b>	<b>56122/5P</b>	<b>(2-26")</b>	<b>6,380</b>
66 30 29	Wood	56133/2P	(2-26")	6,315	56123/2P	(2-26")	6,905
<b>66 30 29</b>	<b>P-Lam</b>	<b>56134/5P</b>	<b>(2-26")</b>	<b>5,920</b>	<b>56124/5P</b>	<b>(2-26")</b>	<b>6,495</b>
72 30 29	Wood	56135/2P	(2-26")	6,505	56125/2P	(2-26")	7,105
<b>72 30 29</b>	<b>P-Lam</b>	<b>56136/5P</b>	<b>(2-26")</b>	<b>6,100</b>	<b>56126/5P</b>	<b>(2-26")</b>	<b>6,680</b>
78 30 29	Wood	56137/2P	(2-26")	6,685	56127/2P	(2-26")	7,240
<b>78 30 29</b>	<b>P-Lam</b>	<b>56138/5P</b>	<b>(2-26")</b>	<b>6,210</b>	<b>56128/5P</b>	<b>(2-26")</b>	<b>6,780</b>
84 30 29	Wood	56139/2P	(2-26")	6,780	56129/2P	(2-26")	7,365
<b>84 30 29</b>	<b>P-Lam</b>	<b>56140/5P</b>	<b>(2-26")</b>	<b>6,300</b>	<b>56130/5P</b>	<b>(2-26")</b>	<b>6,890</b>
90 30 29	Wood	56186/2P	(2-26")	6,915	56184/2P	(2-26")	7,510
<b>90 30 29</b>	<b>P-Lam</b>	<b>56187/5P</b>	<b>(2-26")</b>	<b>6,390</b>	<b>56185/5P</b>	<b>(2-26")</b>	<b>6,970</b>
60 36 29	Wood	56151/2P	(2-26")	6,500	56141/2P	(2-26")	7,100
<b>60 36 29</b>	<b>P-Lam</b>	<b>56152/5P</b>	<b>(2-26")</b>	<b>6,075</b>	<b>56142/5P</b>	<b>(2-26")</b>	<b>6,660</b>
66 36 29	Wood	56153/2P	(2-26")	6,670	56143/2P	(2-26")	7,220
<b>66 36 29</b>	<b>P-Lam</b>	<b>56154/5P</b>	<b>(2-26")</b>	<b>6,185</b>	<b>56144/5P</b>	<b>(2-26")</b>	<b>6,755</b>
72 36 29	Wood	56155/2P	(2-26")	6,905	56145/2P	(2-26")	7,465
<b>72 36 29</b>	<b>P-Lam</b>	<b>56156/5P</b>	<b>(2-26")</b>	<b>6,390</b>	<b>56146/5P</b>	<b>(2-26")</b>	<b>6,970</b>
78 36 29	Wood	56157/2P	(2-26")	7,105	56147/2P	(2-26")	7,660
<b>78 36 29</b>	<b>P-Lam</b>	<b>56158/5P</b>	<b>(2-26")</b>	<b>6,540</b>	<b>56148/5P</b>	<b>(2-26")</b>	<b>7,125</b>
84 36 29	Wood	56159/2P	(2-26")	7,190	56149/2P	(2-26")	7,780
<b>84 36 29</b>	<b>P-Lam</b>	<b>56160/5P</b>	<b>(2-26")</b>	<b>6,640</b>	<b>56150/5P</b>	<b>(2-26")</b>	<b>7,195</b>
90 36 29	Wood	56190/2P	(2-26")	7,325	56188/2P	(2-26")	7,895
<b>90 36 29</b>	<b>P-Lam</b>	<b>56191/5P</b>	<b>(2-26")</b>	<b>6,720</b>	<b>56189/5P</b>	<b>(2-26")</b>	<b>7,315</b>



Flat steel swivel latches allow unlimited positioning for ganging Vox FlipTop tables together.

# VOX® FLIPTOP™ MEETING TABLE

## Flush Legs With Aluminum Modesty Panel



On this page

Wood veneer tables are standard with a 1/8" solid wood edge that has a slight radius and an aluminum modesty panel with grey plastic edging

P-lam tables are standard with a 1/8" translucent edging that has a slight radius and an aluminum modesty panel with grey plastic edging

Tops are 1" Thick

Anodized Finish

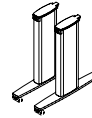

Mirror-polished

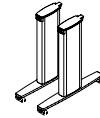

### RECTANGLE TABLES

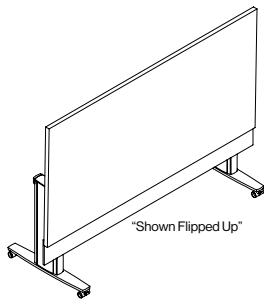
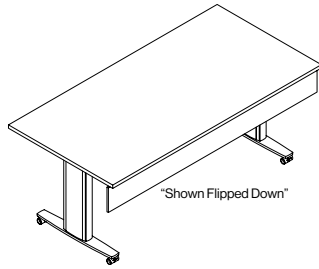

L" x D" x H"	Top Finish	Model Number	2 T-Bases	List Price	Model Number	2 T-Bases	List Price
60 24 29	Wood	56111/2AP	(2-24")	5,900	56101/2AP	(2-24")	6,480
<b>60 24 29</b>	<b>P-Lam</b>	<b>56112/5AP</b>	<b>(2-24")</b>	<b>5,580</b>	<b>56102/5AP</b>	<b>(2-24")</b>	<b>6,165</b>
66 24 29	Wood	56113/2AP	(2-24")	6,015	56103/2AP	(2-24")	6,585
<b>66 24 29</b>	<b>P-Lam</b>	<b>56114/5AP</b>	<b>(2-24")</b>	<b>5,700</b>	<b>56104/5AP</b>	<b>(2-24")</b>	<b>6,275</b>
72 24 29	Wood	56115/2AP	(2-24")	6,170	56105/2AP	(2-24")	6,745
<b>72 24 29</b>	<b>P-Lam</b>	<b>56116/5AP</b>	<b>(2-24")</b>	<b>5,815</b>	<b>56106/5AP</b>	<b>(2-24")</b>	<b>6,390</b>
78 24 29	Wood	56117/2AP	(2-24")	6,300	56107/2AP	(2-24")	6,890
<b>78 24 29</b>	<b>P-Lam</b>	<b>56118/5AP</b>	<b>(2-24")</b>	<b>5,920</b>	<b>56108/5AP</b>	<b>(2-24")</b>	<b>6,495</b>
84 24 29	Wood	56119/2AP	(2-24")	6,420	56109/2AP	(2-24")	6,990
<b>84 24 29</b>	<b>P-Lam</b>	<b>56120/5AP</b>	<b>(2-24")</b>	<b>6,015</b>	<b>56110/5AP</b>	<b>(2-24")</b>	<b>6,585</b>
90 24 29	Wood	56182/2AP	(2-24")	6,540	56180/2AP	(2-24")	7,125
<b>90 24 29</b>	<b>P-Lam</b>	<b>56183/5AP</b>	<b>(2-24")</b>	<b>6,115</b>	<b>56181/5AP</b>	<b>(2-24")</b>	<b>6,695</b>
60 30 29	Wood	56131/2AP	(2-26")	6,215	56121/2AP	(2-26")	6,790
<b>60 30 29</b>	<b>P-Lam</b>	<b>56132/5AP</b>	<b>(2-26")</b>	<b>5,835</b>	<b>56122/5AP</b>	<b>(2-26")</b>	<b>6,420</b>
66 30 29	Wood	56133/2AP	(2-26")	6,355	56123/2AP	(2-26")	6,930
<b>66 30 29</b>	<b>P-Lam</b>	<b>56134/5AP</b>	<b>(2-26")</b>	<b>5,955</b>	<b>56124/5AP</b>	<b>(2-26")</b>	<b>6,535</b>
72 30 29	Wood	56135/2AP	(2-26")	6,550	56125/2AP	(2-26")	7,130
<b>72 30 29</b>	<b>P-Lam</b>	<b>56136/5AP</b>	<b>(2-26")</b>	<b>6,125</b>	<b>56126/5AP</b>	<b>(2-26")</b>	<b>6,710</b>
78 30 29	Wood	56137/2AP	(2-26")	6,715	56127/2AP	(2-26")	7,310
<b>78 30 29</b>	<b>P-Lam</b>	<b>56138/5AP</b>	<b>(2-26")</b>	<b>6,260</b>	<b>56128/5AP</b>	<b>(2-26")</b>	<b>6,840</b>
84 30 29	Wood	56139/2AP	(2-26")	6,840	56129/2AP	(2-26")	7,405
<b>84 30 29</b>	<b>P-Lam</b>	<b>56140/5AP</b>	<b>(2-26")</b>	<b>6,340</b>	<b>56130/5AP</b>	<b>(2-26")</b>	<b>6,920</b>
90 30 29	Wood	56186/2AP	(2-26")	6,945	56184/2AP	(2-26")	7,535
<b>90 30 29</b>	<b>P-Lam</b>	<b>56187/5AP</b>	<b>(2-26")</b>	<b>6,455</b>	<b>56185/5AP</b>	<b>(2-26")</b>	<b>7,005</b>
60 36 29	Wood	56151/2AP	(2-26")	6,540	56141/2AP	(2-26")	7,125
<b>60 36 29</b>	<b>P-Lam</b>	<b>56152/5AP</b>	<b>(2-26")</b>	<b>6,110</b>	<b>56142/5AP</b>	<b>(2-26")</b>	<b>6,690</b>
66 36 29	Wood	56153/2AP	(2-26")	6,700	56143/2AP	(2-26")	7,300
<b>66 36 29</b>	<b>P-Lam</b>	<b>56154/5AP</b>	<b>(2-26")</b>	<b>6,225</b>	<b>56144/5AP</b>	<b>(2-26")</b>	<b>6,800</b>
72 36 29	Wood	56155/2AP	(2-26")	6,930	56145/2AP	(2-26")	7,525
<b>72 36 29</b>	<b>P-Lam</b>	<b>56156/5AP</b>	<b>(2-26")</b>	<b>6,455</b>	<b>56146/5AP</b>	<b>(2-26")</b>	<b>7,005</b>
78 36 29	Wood	56157/2AP	(2-26")	7,130	56147/2AP	(2-26")	7,710
<b>78 36 29</b>	<b>P-Lam</b>	<b>56158/5AP</b>	<b>(2-26")</b>	<b>6,580</b>	<b>56148/5AP</b>	<b>(2-26")</b>	<b>7,155</b>
84 36 29	Wood	56159/2AP	(2-26")	7,220	56149/2AP	(2-26")	7,820
<b>84 36 29</b>	<b>P-Lam</b>	<b>56160/5AP</b>	<b>(2-26")</b>	<b>6,680</b>	<b>56150/5AP</b>	<b>(2-26")</b>	<b>7,230</b>
90 36 29	Wood	56190/2AP	(2-26")	7,360	56188/2AP	(2-26")	7,940
<b>90 36 29</b>	<b>P-Lam</b>	<b>56191/5AP</b>	<b>(2-26")</b>	<b>6,755</b>	<b>56189/5AP</b>	<b>(2-26")</b>	<b>7,340</b>

Vox FlipTop tables with aluminum modesty panels.



# VOX® MEETING ROOM LAYOUTS

Flush Legs Drawings not to scale

ROOM1-LAYOUT A1

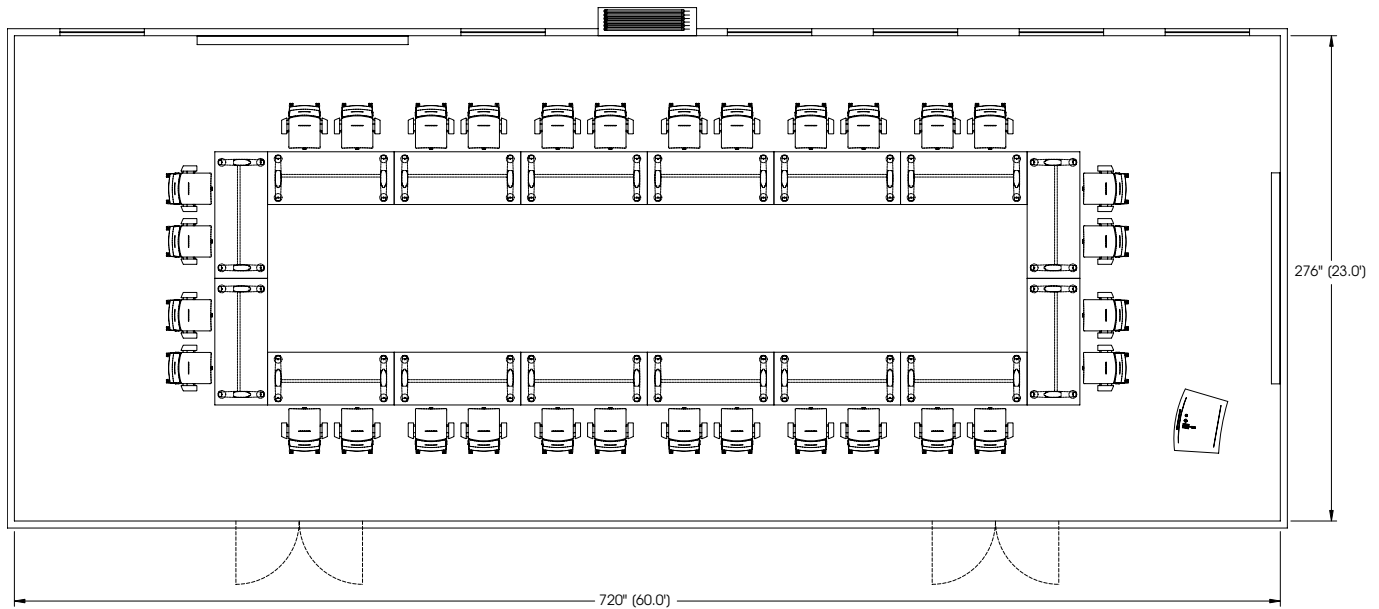

ROOM1-LAYOUT A2

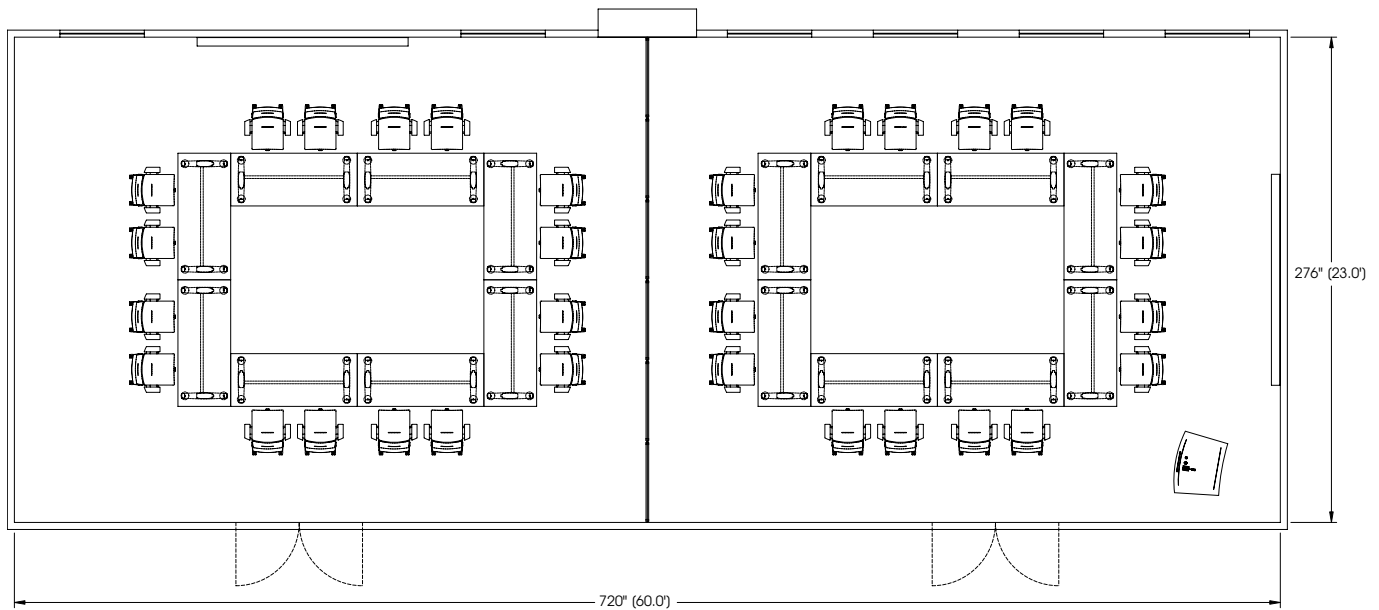

Product Name	Model Number	List Price
16-Vox® FlipTop™ 72" x 30" tables	56135/2	103,970
1-VoX® Presenter's Lectern	23465	12,420
32-NOW® Conference Chairs, with casters	13022	57,645
<b>Total</b>		<b>174,030</b>

# VOX® MEETING ROOM LAYOUTS

Flush Legs Drawings not to scale

ROOM1-LAYOUT A3

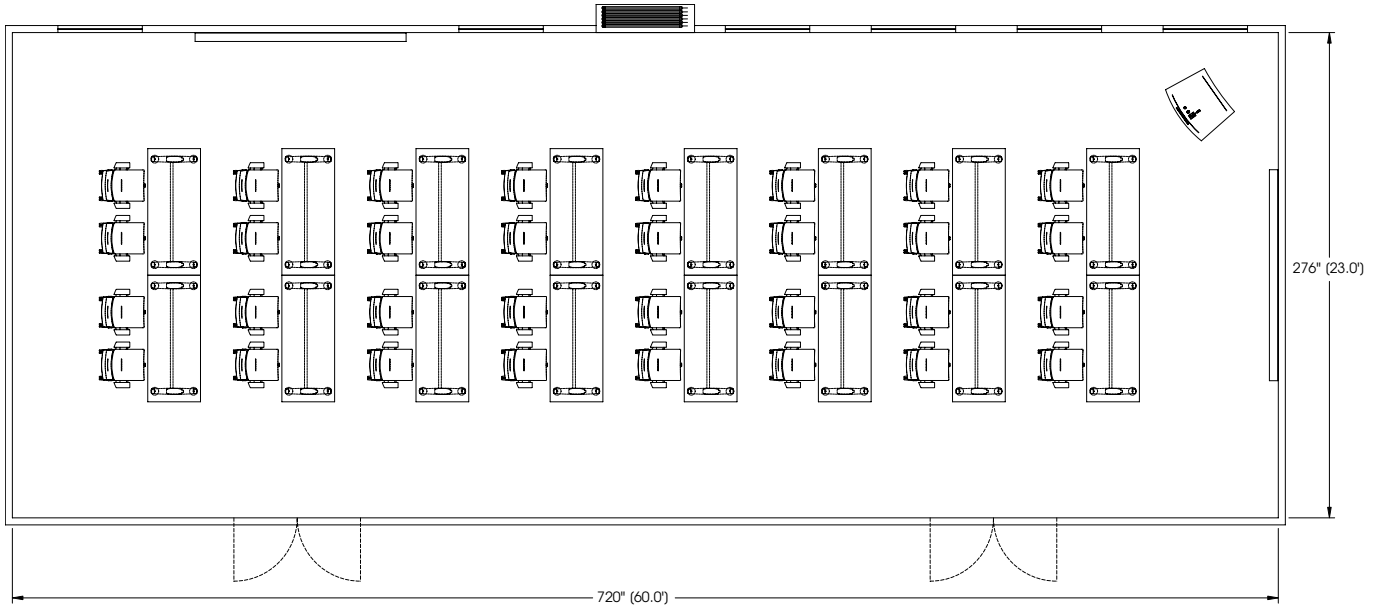

ROOM1-LAYOUT A4

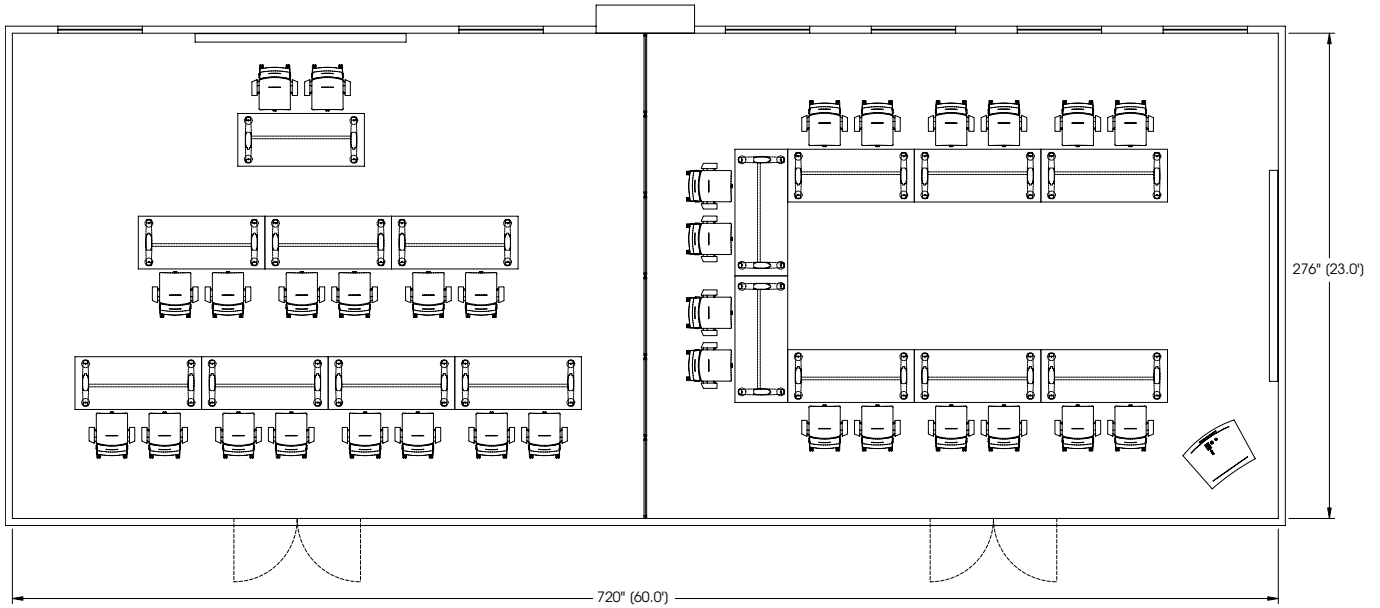

Product Name	Model Number	List Price
16-Vox® FlipTop™ 72" x 30" tables	56135/2	103,970
1-Vox® Presenter's Lectern	23465	12,420
32-NOW® Conference Chairs, with casters	13022	57,645
<b>Total</b>		<b>174,030</b>

# VOX® MEETING ROOM LAYOUTS

Flush Legs Drawings not to scale

ROOM 2 – LAYOUT B1

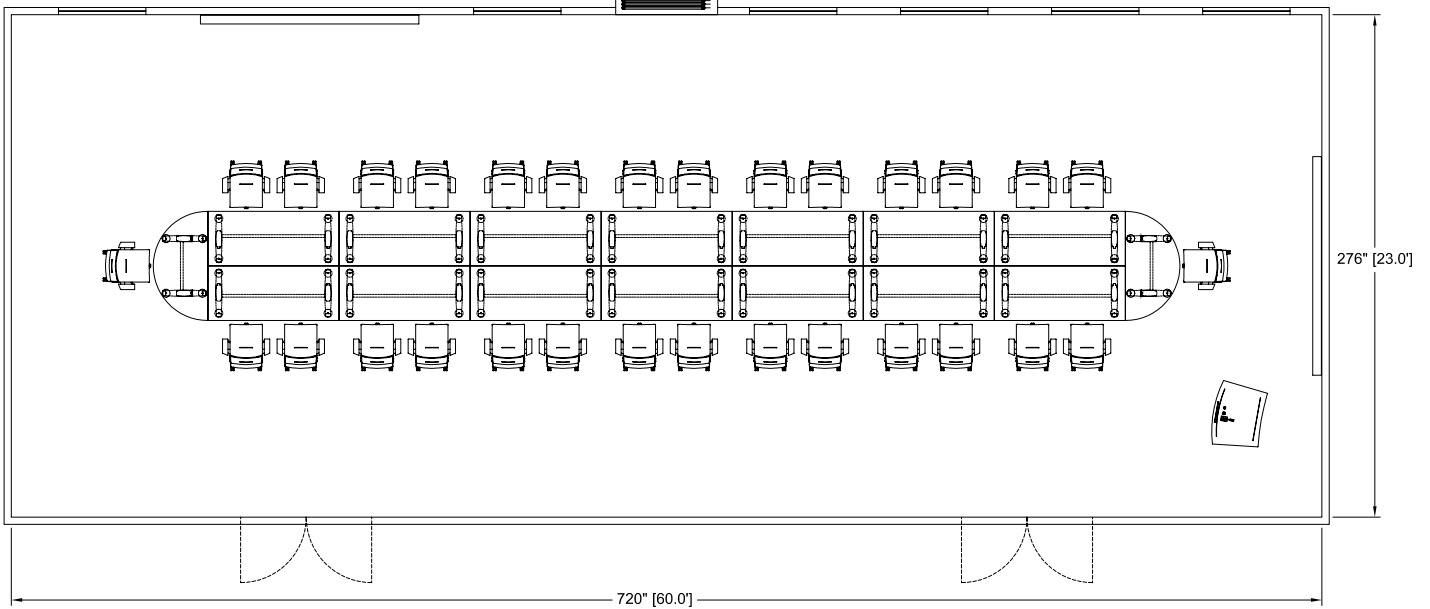

ROOM 2 – LAYOUT B2

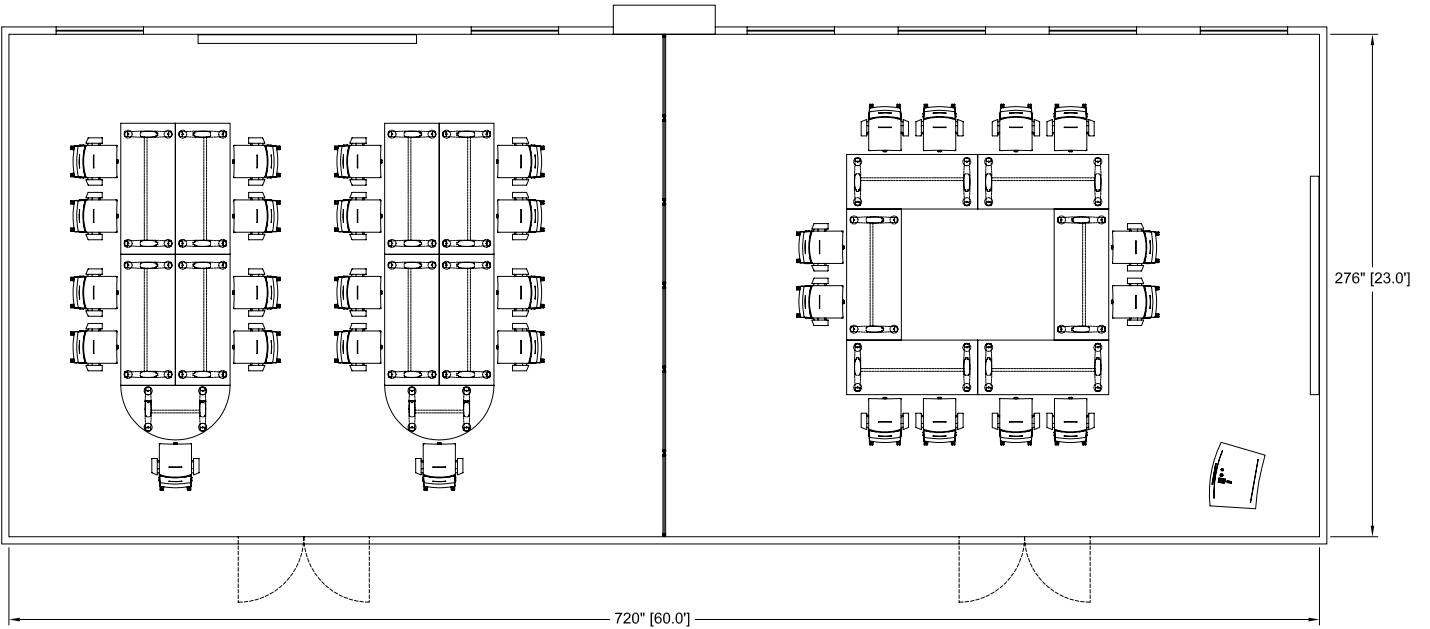

Product Name	Model Number	List Price
14-Vox® FlipTop™ 72" x 30" tables	56135/2	90,975
2-Vox® FlipTop™ Half Round 60" x 30" tables	56171/2	10,595
1-Vox® Presenter's Lectern	23465	12,420
30-NOW® Conference Chairs, with casters	13022	54,050
<b>Total</b>		<b>168,020</b>

**VOX® FLIPTOP™ MEETING TABLES  
WITH INSET LEGS**

# PLANNING WITH VOX® FLIPTOP™ TABLES

## Inset Legs vs Flush Legs Design – Mark Müller

Simple and effective tools are available for any space planning required. You can access a full set of PDF and CAD files for Vox® FlipTop™ tables by following the links below.

Type [www.nienkamper.com](http://www.nienkamper.com) in your browser

Pick the Products Tab heading, (top left)

Select the FlipTop/Meeting Tables category

Select Vox® FlipTop™ Product and scroll down to resources

Drawings based on seating quantities are listed from 6 to 30 seats and offer a plan view of all options available.

Sample file to seat 10:

IGFgroup

**nienkämper**

## VOX® FLIPTOP™ TABLES

### 10 SEATS

(BASED ON CHAIR WIDTH OF 26")

KEY: FL-OG-A1  
 "FL" = FLUSH / "IN" = INSET  
 SEATING QUANTITY  
 TABLE DEPTH  
 \*A"=24" / \*B"=30" / \*C"=36"  
 LAYOUT VERSION (1,2,3...)

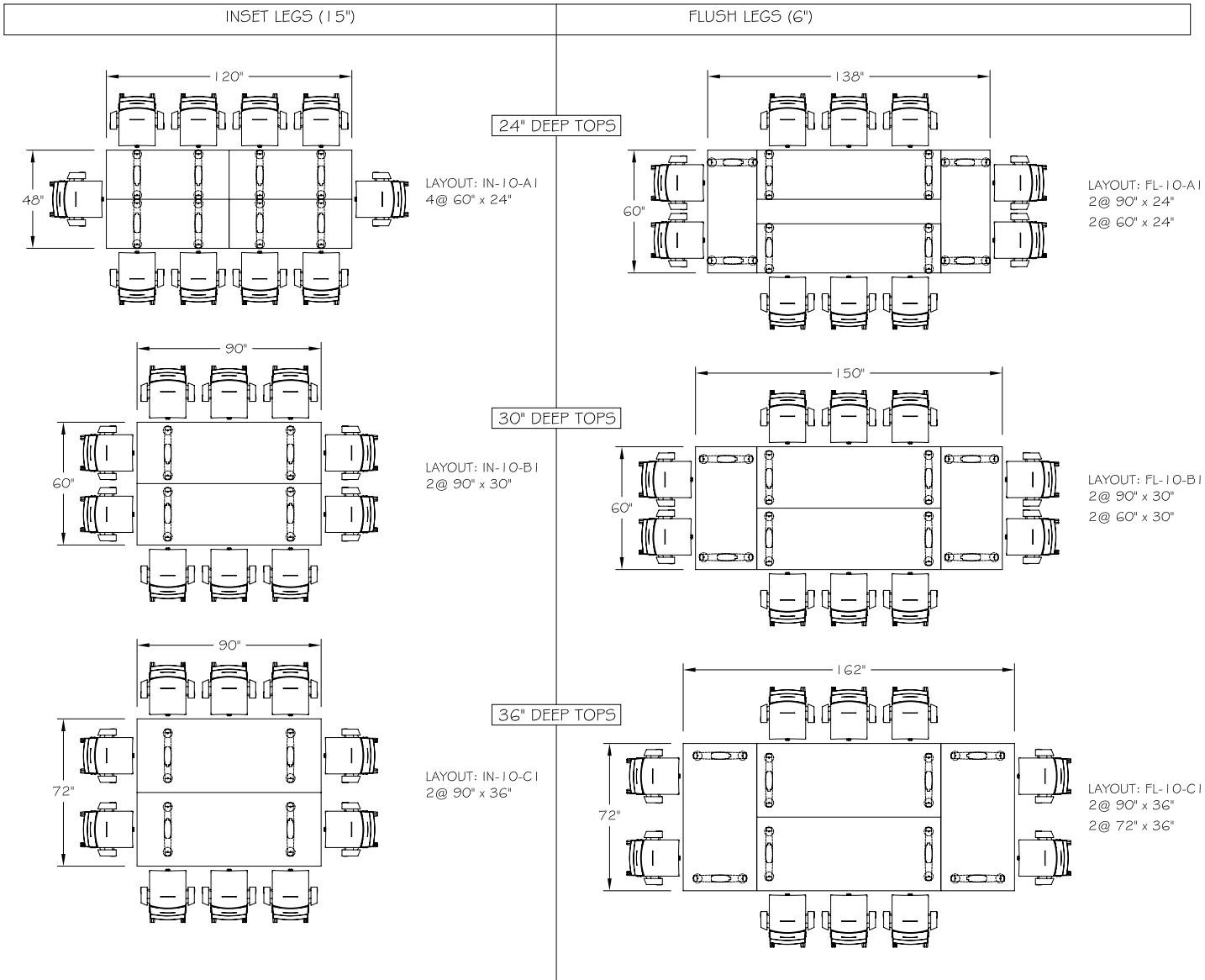

THIS DRAWING IS CONFIDENTIAL AND PROPRIETARY. NO PART OF THIS DRAWING MAY BE COPIED, DISCLOSED TO ANY THIRD PARTY OR USED FOR ANY PURPOSE WITHOUT THE EXPRESS WRITTEN AUTHORIZATION OF NIENKÄMPER FURNITURE & ACCESSORIES

# VOX® FLIPTOP™ MEETING TABLE

**Inset Legs** Design – Mark Müller

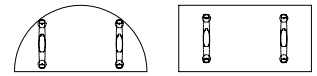

On this page:

Wood veneer tables are standard with a 1/8" solid wood edge that has a slight radius.

P-lam tables are standard with a 1/8" translucent edging that has a slight radius.

Anodized Finish

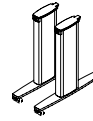

Mirror-polished

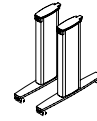

Tops are 1" Thick

## RECTANGLE TABLES

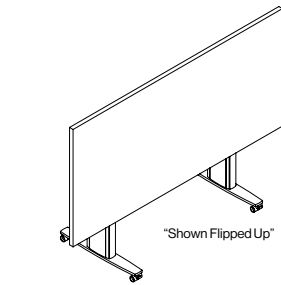
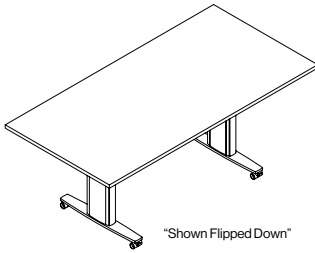

## HALF-ROUND TABLES

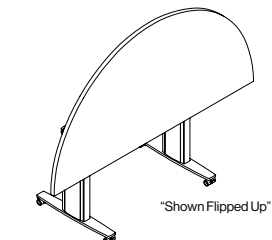
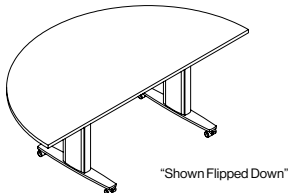

	L" x	D" x	H"	Top Finish	Model Number	2 T-Bases	List Price	Model Number	2 T-Bases	List Price
	60	24	29	Wood	56416/2	(2-24")	4,980	56410/2	(2-24")	5,560
	<b>60</b>	<b>24</b>	<b>29</b>	<b>P-Lam</b>	<b>56416/5</b>	<b>(2-24")</b>	<b>4,745</b>	<b>56410/5</b>	<b>(2-24")</b>	<b>5,325</b>
	66	24	29	Wood	56417/2	(2-24")	5,095	56411/2	(2-24")	5,670
	<b>66</b>	<b>24</b>	<b>29</b>	<b>P-Lam</b>	<b>56417/5</b>	<b>(2-24")</b>	<b>4,840</b>	<b>56411/5</b>	<b>(2-24")</b>	<b>5,420</b>
	72	24	29	Wood	56418/2	(2-24")	5,245	56412/2	(2-24")	5,815
	<b>72</b>	<b>24</b>	<b>29</b>	<b>P-Lam</b>	<b>56418/5</b>	<b>(2-24")</b>	<b>4,965</b>	<b>56412/5</b>	<b>(2-24")</b>	<b>5,540</b>
	78	24	29	Wood	56419/2	(2-24")	5,355	56413/2	(2-24")	5,930
	<b>78</b>	<b>24</b>	<b>29</b>	<b>P-Lam</b>	<b>56419/5</b>	<b>(2-24")</b>	<b>5,055</b>	<b>56413/5</b>	<b>(2-24")</b>	<b>5,625</b>
	84	24	29	Wood	56420/2	(2-24")	5,475	56414/2	(2-24")	6,040
	<b>84</b>	<b>24</b>	<b>29</b>	<b>P-Lam</b>	<b>56420/5</b>	<b>(2-24")</b>	<b>5,145</b>	<b>56414/5</b>	<b>(2-24")</b>	<b>5,720</b>
	90	24	29	Wood	56421/2	(2-24")	5,580	56415/2	(2-24")	6,165
	<b>90</b>	<b>24</b>	<b>29</b>	<b>P-Lam</b>	<b>56421/5</b>	<b>(2-24")</b>	<b>5,235</b>	<b>56415/5</b>	<b>(2-24")</b>	<b>5,810</b>
	60	30	29	Wood	56428/2	(2-26")	5,305	56422/2	(2-26")	5,895
	<b>60</b>	<b>30</b>	<b>29</b>	<b>P-Lam</b>	<b>56428/5</b>	<b>(2-26")</b>	<b>5,005</b>	<b>56422/5</b>	<b>(2-26")</b>	<b>5,580</b>
	66	30	29	Wood	56429/2	(2-26")	5,430	56423/2	(2-26")	6,015
	<b>66</b>	<b>30</b>	<b>29</b>	<b>P-Lam</b>	<b>56429/5</b>	<b>(2-26")</b>	<b>5,105</b>	<b>56423/5</b>	<b>(2-26")</b>	<b>5,700</b>
	72	30	29	Wood	56430/2	(2-26")	5,620	56424/2	(2-26")	6,205
	<b>72</b>	<b>30</b>	<b>29</b>	<b>P-Lam</b>	<b>56430/5</b>	<b>(2-26")</b>	<b>5,270</b>	<b>56424/5</b>	<b>(2-26")</b>	<b>5,855</b>
	78	30	29	Wood	56431/2	(2-26")	5,765	56425/2	(2-26")	6,345
	<b>78</b>	<b>30</b>	<b>29</b>	<b>P-Lam</b>	<b>56431/5</b>	<b>(2-26")</b>	<b>5,385</b>	<b>56425/5</b>	<b>(2-26")</b>	<b>5,970</b>
	84	30	29	Wood	56432/2	(2-26")	5,890	56426/2	(2-26")	6,465
	<b>84</b>	<b>30</b>	<b>29</b>	<b>P-Lam</b>	<b>56432/5</b>	<b>(2-26")</b>	<b>5,475</b>	<b>56426/5</b>	<b>(2-26")</b>	<b>6,040</b>
	90	30	29	Wood	56433/2	(2-26")	5,995	56427/2	(2-26")	6,565
	<b>90</b>	<b>30</b>	<b>29</b>	<b>P-Lam</b>	<b>56433/5</b>	<b>(2-26")</b>	<b>5,560</b>	<b>56427/5</b>	<b>(2-26")</b>	<b>6,135</b>
	60	36	29	Wood	56440/2	(2-26")	5,625	56434/2	(2-26")	6,210
	<b>60</b>	<b>36</b>	<b>29</b>	<b>P-Lam</b>	<b>56440/5</b>	<b>(2-26")</b>	<b>5,265</b>	<b>56434/5</b>	<b>(2-26")</b>	<b>5,835</b>
	66	36	29	Wood	56441/2	(2-26")	5,785	56435/2	(2-26")	6,355
	<b>66</b>	<b>36</b>	<b>29</b>	<b>P-Lam</b>	<b>56441/5</b>	<b>(2-26")</b>	<b>5,375</b>	<b>56435/5</b>	<b>(2-26")</b>	<b>5,955</b>
	72	36	29	Wood	56442/2	(2-26")	6,005	56436/2	(2-26")	6,580
	<b>72</b>	<b>36</b>	<b>29</b>	<b>P-Lam</b>	<b>56442/5</b>	<b>(2-26")</b>	<b>5,580</b>	<b>56436/5</b>	<b>(2-26")</b>	<b>6,165</b>
	78	36	29	Wood	56443/2	(2-26")	6,185	56437/2	(2-26")	6,755
	<b>78</b>	<b>36</b>	<b>29</b>	<b>P-Lam</b>	<b>56443/5</b>	<b>(2-26")</b>	<b>5,720</b>	<b>56437/5</b>	<b>(2-26")</b>	<b>6,300</b>
	84	36	29	Wood	56444/2	(2-26")	6,285	56438/2	(2-26")	6,875
	<b>84</b>	<b>36</b>	<b>29</b>	<b>P-Lam</b>	<b>56444/5</b>	<b>(2-26")</b>	<b>5,795</b>	<b>56438/5</b>	<b>(2-26")</b>	<b>6,370</b>
	90	36	29	Wood	56445/2	(2-26")	6,390	56439/2	(2-26")	6,970
	<b>90</b>	<b>36</b>	<b>29</b>	<b>P-Lam</b>	<b>56445/5</b>	<b>(2-26")</b>	<b>5,895</b>	<b>56439/5</b>	<b>(2-26")</b>	<b>6,475</b>
	30	60	29	Wood	56171/2	(2-24")	5,305	56161/2	(2-24")	5,895
	<b>30</b>	<b>60</b>	<b>29</b>	<b>P-Lam</b>	<b>56172/5</b>	<b>(2-24")</b>	<b>5,005</b>	<b>56162/5</b>	<b>(2-24")</b>	<b>5,580</b>
	36	72	29	Wood	56173/2	(2-26")	5,475	56163/2	(2-26")	6,040
	<b>36</b>	<b>72</b>	<b>29</b>	<b>P-Lam</b>	<b>56174/5</b>	<b>(2-26")</b>	<b>5,145</b>	<b>56164/5</b>	<b>(2-26")</b>	<b>5,720</b>

# VOX® FLIPTOP™ MEETING TABLE

**Inset Legs With Wood or P-Lam Modesty Panel** Design – Mark Müller

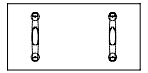

On this page:

Wood veneer tables are standard with a 1/8" solid wood edge that has a slight radius and a with wood veneer modesty panel that is self edged

P-lam tables are standard with a 1/8" translucent edging that has a slight radius and a plastic laminate modesty panel with translucent edging to match the top

Tops are 1" Thick

Anodized Finish

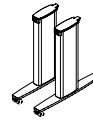

Mirror-polished

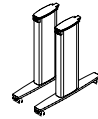

## RECTANGLE TABLES

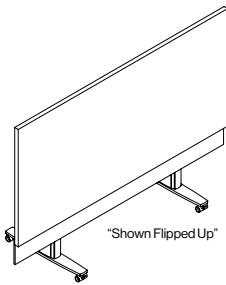
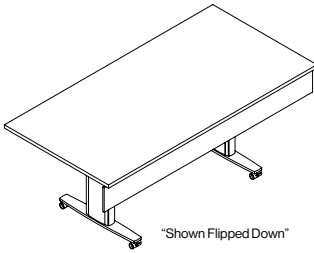

L" x D" x H"	Top Finish	Model Number	2 T-Bases	List Price	Model Number	2 T-Bases	List Price
60 24 29	Wood	56416/2P	(2-24")	5,855	56410/2P	(2-24")	6,440
<b>60 24 29</b>	<b>P-Lam</b>	<b>56416/5P</b>	<b>(2-24")</b>	<b>5,540</b>	<b>56410/5P</b>	<b>(2-24")</b>	<b>6,120</b>
66 24 29	Wood	56417/2P	(2-24")	5,975	56411/2P	(2-24")	6,550
<b>66 24 29</b>	<b>P-Lam</b>	<b>56417/5P</b>	<b>(2-24")</b>	<b>5,650</b>	<b>56411/5P</b>	<b>(2-24")</b>	<b>6,225</b>
72 24 29	Wood	56418/2P	(2-24")	6,125	56412/2P	(2-24")	6,710
<b>72 24 29</b>	<b>P-Lam</b>	<b>56418/5P</b>	<b>(2-24")</b>	<b>5,785</b>	<b>56412/5P</b>	<b>(2-24")</b>	<b>6,355</b>
78 24 29	Wood	56419/2P	(2-24")	6,270	56413/2P	(2-24")	6,860
<b>78 24 29</b>	<b>P-Lam</b>	<b>56419/5P</b>	<b>(2-24")</b>	<b>5,890</b>	<b>56413/5P</b>	<b>(2-24")</b>	<b>6,465</b>
84 24 29	Wood	56420/2P	(2-24")	6,380	56414/2P	(2-24")	6,950
<b>84 24 29</b>	<b>P-Lam</b>	<b>56420/5P</b>	<b>(2-24")</b>	<b>5,975</b>	<b>56414/5P</b>	<b>(2-24")</b>	<b>6,550</b>
90 24 29	Wood	56421/2P	(2-24")	6,500	56415/2P	(2-24")	7,100
<b>90 24 29</b>	<b>P-Lam</b>	<b>56421/5P</b>	<b>(2-24")</b>	<b>6,080</b>	<b>56415/5P</b>	<b>(2-24")</b>	<b>6,665</b>
60 30 29	Wood	56428/2P	(2-26")	6,175	56422/2P	(2-26")	6,750
<b>60 30 29</b>	<b>P-Lam</b>	<b>56428/5P</b>	<b>(2-26")</b>	<b>5,800</b>	<b>56422/5P</b>	<b>(2-26")</b>	<b>6,380</b>
66 30 29	Wood	56429/2P	(2-26")	6,315	56423/2P	(2-26")	6,905
<b>66 30 29</b>	<b>P-Lam</b>	<b>56429/5P</b>	<b>(2-26")</b>	<b>5,920</b>	<b>56423/5P</b>	<b>(2-26")</b>	<b>6,495</b>
72 30 29	Wood	56430/2P	(2-26")	6,505	56424/2P	(2-26")	7,105
<b>72 30 29</b>	<b>P-Lam</b>	<b>56430/5P</b>	<b>(2-26")</b>	<b>6,100</b>	<b>56424/5P</b>	<b>(2-26")</b>	<b>6,680</b>
78 30 29	Wood	56431/2P	(2-26")	6,685	56425/2P	(2-26")	7,240
<b>78 30 29</b>	<b>P-Lam</b>	<b>56431/5P</b>	<b>(2-26")</b>	<b>6,210</b>	<b>56425/5P</b>	<b>(2-26")</b>	<b>6,780</b>
84 30 29	Wood	56432/2P	(2-26")	6,780	56426/2P	(2-26")	7,365
<b>84 30 29</b>	<b>P-Lam</b>	<b>56432/5P</b>	<b>(2-26")</b>	<b>6,300</b>	<b>56426/5P</b>	<b>(2-26")</b>	<b>6,890</b>
90 30 29	Wood	56433/2P	(2-26")	6,915	56427/2P	(2-26")	7,510
<b>90 30 29</b>	<b>P-Lam</b>	<b>56433/5P</b>	<b>(2-26")</b>	<b>6,390</b>	<b>56427/5P</b>	<b>(2-26")</b>	<b>6,970</b>
60 36 29	Wood	56440/2P	(2-26")	6,500	56434/2P	(2-26")	7,100
<b>60 36 29</b>	<b>P-Lam</b>	<b>56440/5P</b>	<b>(2-26")</b>	<b>6,075</b>	<b>56434/5P</b>	<b>(2-26")</b>	<b>6,660</b>
66 36 29	Wood	56441/2P	(2-26")	6,670	56435/2P	(2-26")	7,220
<b>66 36 29</b>	<b>P-Lam</b>	<b>56441/5P</b>	<b>(2-26")</b>	<b>6,185</b>	<b>56435/5P</b>	<b>(2-26")</b>	<b>6,755</b>
72 36 29	Wood	56442/2P	(2-26")	6,905	56436/2P	(2-26")	7,465
<b>72 36 29</b>	<b>P-Lam</b>	<b>56442/5P</b>	<b>(2-26")</b>	<b>6,390</b>	<b>56436/5P</b>	<b>(2-26")</b>	<b>6,970</b>
78 36 29	Wood	56443/2P	(2-26")	7,105	56437/2P	(2-26")	7,660
<b>78 36 29</b>	<b>P-Lam</b>	<b>56443/5P</b>	<b>(2-26")</b>	<b>6,540</b>	<b>56437/5P</b>	<b>(2-26")</b>	<b>7,125</b>
84 36 29	Wood	56444/2P	(2-26")	7,190	56438/2P	(2-26")	7,780
<b>84 36 29</b>	<b>P-Lam</b>	<b>56444/5P</b>	<b>(2-26")</b>	<b>6,640</b>	<b>56438/5P</b>	<b>(2-26")</b>	<b>7,195</b>
90 36 29	Wood	56445/2P	(2-26")	7,325	56439/2P	(2-26")	7,895
<b>90 36 29</b>	<b>P-Lam</b>	<b>56445/5P</b>	<b>(2-26")</b>	<b>6,720</b>	<b>56439/5P</b>	<b>(2-26")</b>	<b>7,315</b>

# VOX® FLIPTOP™ MEETING TABLE

Inset Legs With Aluminum Modesty Panel Design – Mark Müller

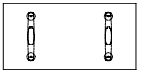

On this page

Wood veneer tables are standard with a 1/8" solid wood edge that has a slight radius and an aluminum modesty panel with grey plastic edging

P-lam tables are standard with a 1/8" translucent edging that has a slight radius and an aluminum modesty panel with grey plastic edging

Tops are 1" Thick

Anodized Finish

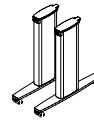

Mirror-polished

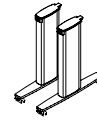

## RECTANGLE TABLES

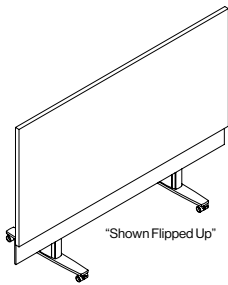
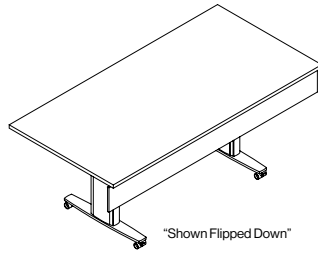

L" x D" x H"	Top Finish	Model Number	2 T-Bases	List Price	Model Number	2 T-Bases	List Price
60 24 29	Wood	56416/2AP	(2-24")	5,900	56410/2AP	(2-24")	6,480
<b>60 24 29</b>	<b>P-Lam</b>	<b>56416/5AP</b>	<b>(2-24")</b>	<b>5,580</b>	<b>56410/5AP</b>	<b>(2-24")</b>	<b>6,165</b>
66 24 29	Wood	56417/2AP	(2-24")	6,015	56411/2AP	(2-24")	6,585
<b>66 24 29</b>	<b>P-Lam</b>	<b>56417/5AP</b>	<b>(2-24")</b>	<b>5,700</b>	<b>56411/5AP</b>	<b>(2-24")</b>	<b>6,275</b>
72 24 29	Wood	56418/2AP	(2-24")	6,170	56412/2AP	(2-24")	6,745
<b>72 24 29</b>	<b>P-Lam</b>	<b>56418/5AP</b>	<b>(2-24")</b>	<b>5,815</b>	<b>56412/5AP</b>	<b>(2-24")</b>	<b>6,390</b>
78 24 29	Wood	56419/2AP	(2-24")	6,300	56413/2AP	(2-24")	6,890
<b>78 24 29</b>	<b>P-Lam</b>	<b>56419/5AP</b>	<b>(2-24")</b>	<b>5,920</b>	<b>56413/5AP</b>	<b>(2-24")</b>	<b>6,495</b>
84 24 29	Wood	56420/2AP	(2-24")	6,420	56414/2AP	(2-24")	6,990
<b>84 24 29</b>	<b>P-Lam</b>	<b>56420/5AP</b>	<b>(2-24")</b>	<b>6,015</b>	<b>56414/5AP</b>	<b>(2-24")</b>	<b>6,585</b>
90 24 29	Wood	56421/2AP	(2-24")	6,540	56415/2AP	(2-24")	7,125
<b>90 24 29</b>	<b>P-Lam</b>	<b>56421/5AP</b>	<b>(2-24")</b>	<b>6,115</b>	<b>56415/5AP</b>	<b>(2-24")</b>	<b>6,695</b>
60 30 29	Wood	56428/2AP	(2-26")	6,215	56422/2AP	(2-26")	6,790
<b>60 30 29</b>	<b>P-Lam</b>	<b>56428/5AP</b>	<b>(2-26")</b>	<b>5,835</b>	<b>56422/5AP</b>	<b>(2-26")</b>	<b>6,420</b>
66 30 29	Wood	56429/2AP	(2-26")	6,355	56423/2AP	(2-26")	6,930
<b>66 30 29</b>	<b>P-Lam</b>	<b>56429/5AP</b>	<b>(2-26")</b>	<b>5,955</b>	<b>56423/5AP</b>	<b>(2-26")</b>	<b>6,535</b>
72 30 29	Wood	56430/2AP	(2-26")	6,550	56424/2AP	(2-26")	7,130
<b>72 30 29</b>	<b>P-Lam</b>	<b>56430/5AP</b>	<b>(2-26")</b>	<b>6,125</b>	<b>56424/5AP</b>	<b>(2-26")</b>	<b>6,710</b>
78 30 29	Wood	56431/2AP	(2-26")	6,715	56425/2AP	(2-26")	7,310
<b>78 30 29</b>	<b>P-Lam</b>	<b>56431/5AP</b>	<b>(2-26")</b>	<b>6,260</b>	<b>56425/5AP</b>	<b>(2-26")</b>	<b>6,840</b>
84 30 29	Wood	56432/2AP	(2-26")	6,840	56426/2AP	(2-26")	7,405
<b>84 30 29</b>	<b>P-Lam</b>	<b>56432/5AP</b>	<b>(2-26")</b>	<b>6,340</b>	<b>56426/5AP</b>	<b>(2-26")</b>	<b>6,920</b>
90 30 29	Wood	56433/2AP	(2-26")	6,945	56427/2AP	(2-26")	7,535
<b>90 30 29</b>	<b>P-Lam</b>	<b>56433/5AP</b>	<b>(2-26")</b>	<b>6,455</b>	<b>56427/5AP</b>	<b>(2-26")</b>	<b>7,005</b>
60 36 29	Wood	56440/2AP	(2-26")	6,540	56434/2AP	(2-26")	7,125
<b>60 36 29</b>	<b>P-Lam</b>	<b>56440/5AP</b>	<b>(2-26")</b>	<b>6,110</b>	<b>56434/5AP</b>	<b>(2-26")</b>	<b>6,690</b>
66 36 29	Wood	56441/2AP	(2-26")	6,700	56435/2AP	(2-26")	7,300
<b>66 36 29</b>	<b>P-Lam</b>	<b>56441/5AP</b>	<b>(2-26")</b>	<b>6,225</b>	<b>56435/5AP</b>	<b>(2-26")</b>	<b>6,800</b>
72 36 29	Wood	56442/2AP	(2-26")	6,930	56436/2AP	(2-26")	7,525
<b>72 36 29</b>	<b>P-Lam</b>	<b>56442/5AP</b>	<b>(2-26")</b>	<b>6,455</b>	<b>56436/5AP</b>	<b>(2-26")</b>	<b>7,005</b>
78 36 29	Wood	56443/2AP	(2-26")	7,130	56437/2AP	(2-26")	7,710
<b>78 36 29</b>	<b>P-Lam</b>	<b>56443/5AP</b>	<b>(2-26")</b>	<b>6,580</b>	<b>56437/5AP</b>	<b>(2-26")</b>	<b>7,155</b>
84 36 29	Wood	56444/2AP	(2-26")	7,220	56438/2AP	(2-26")	7,820
<b>84 36 29</b>	<b>P-Lam</b>	<b>56444/5AP</b>	<b>(2-26")</b>	<b>6,680</b>	<b>56438/5AP</b>	<b>(2-26")</b>	<b>7,230</b>
90 36 29	Wood	56445/2AP	(2-26")	7,360	56439/2AP	(2-26")	7,940
<b>90 36 29</b>	<b>P-Lam</b>	<b>56445/5AP</b>	<b>(2-26")</b>	<b>6,755</b>	<b>56439/5AP</b>	<b>(2-26")</b>	<b>7,340</b>



# VOX® MEETING ROOM LAYOUTS

**Inset Legs** Drawings not to scale

ROOM1-LAYOUT C1

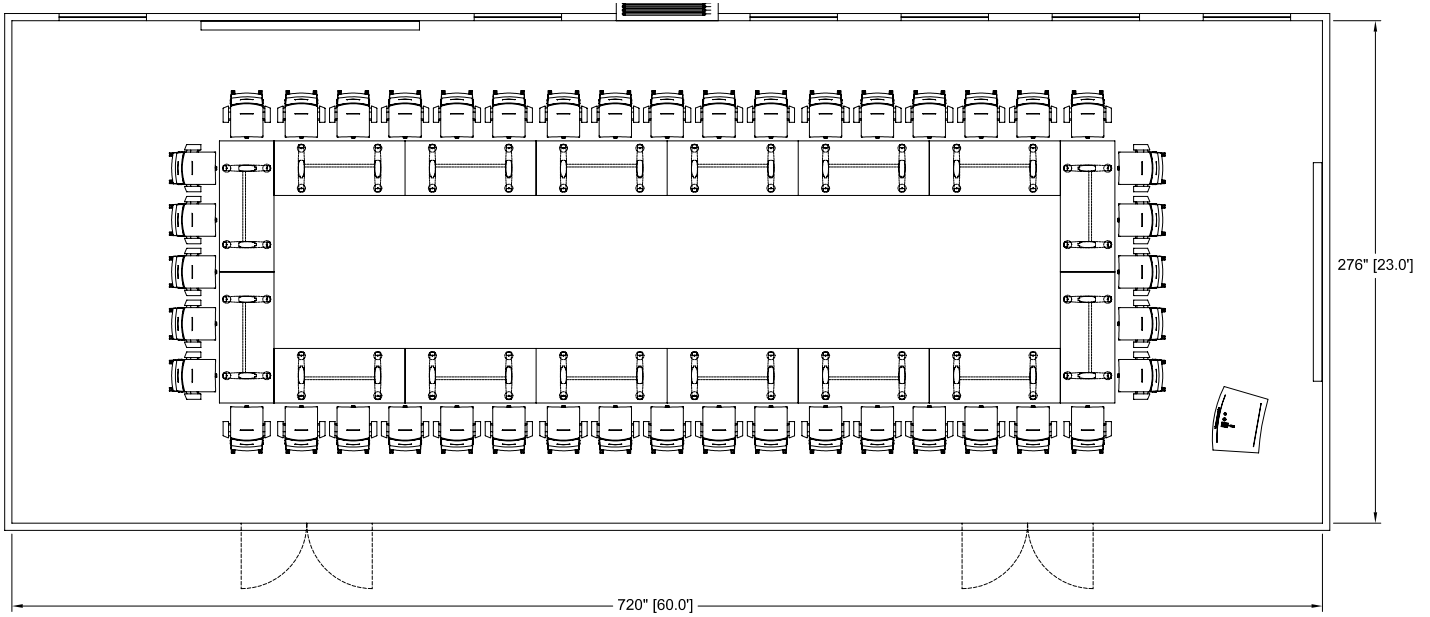

ROOM1-LAYOUT C2

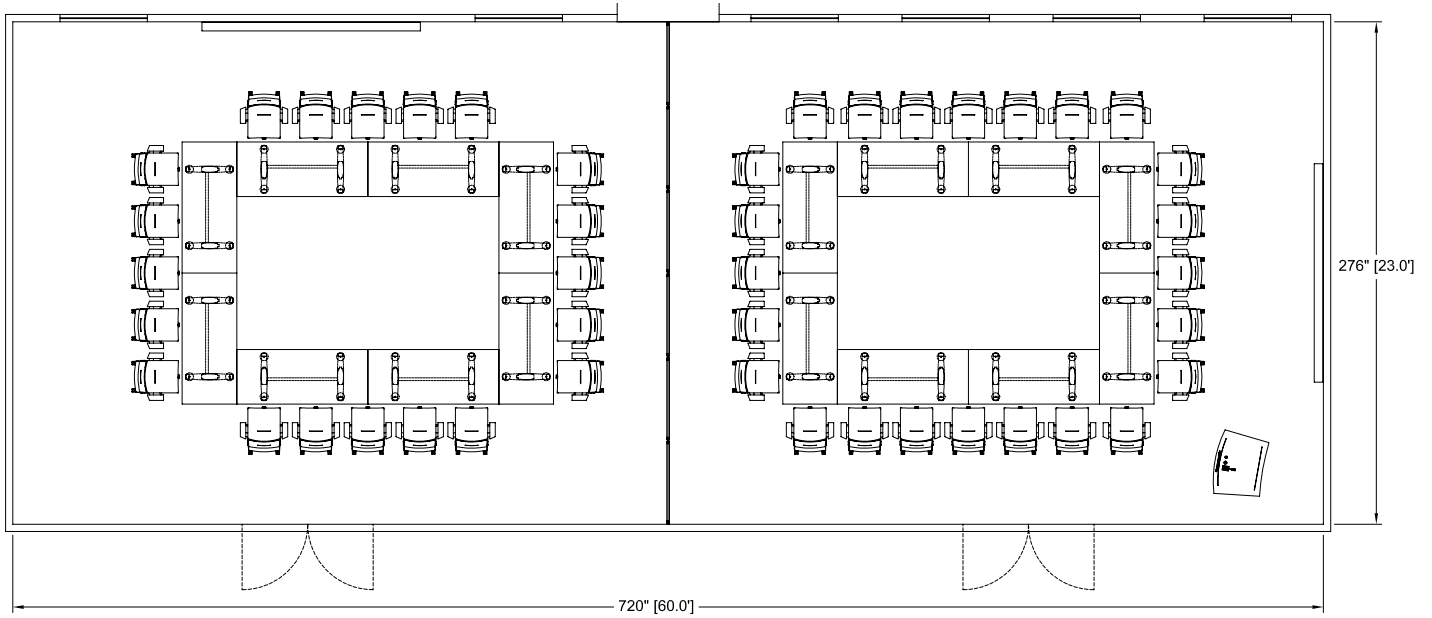

Product Name	Model Number	List Price
16-Vox® FlipTop™ 72" x 30" tables	56430/2	89,835
1-Vox® Presenter's Lectern	23465	12,420
44-NOW® Conference Chairs, with casters	13022	79,260
<b>Total</b>		<b>181,510</b>

# VOX® MEETING ROOM LAYOUTS

**Inset Legs** Drawings not to scale

ROOM 1 – LAYOUT C3

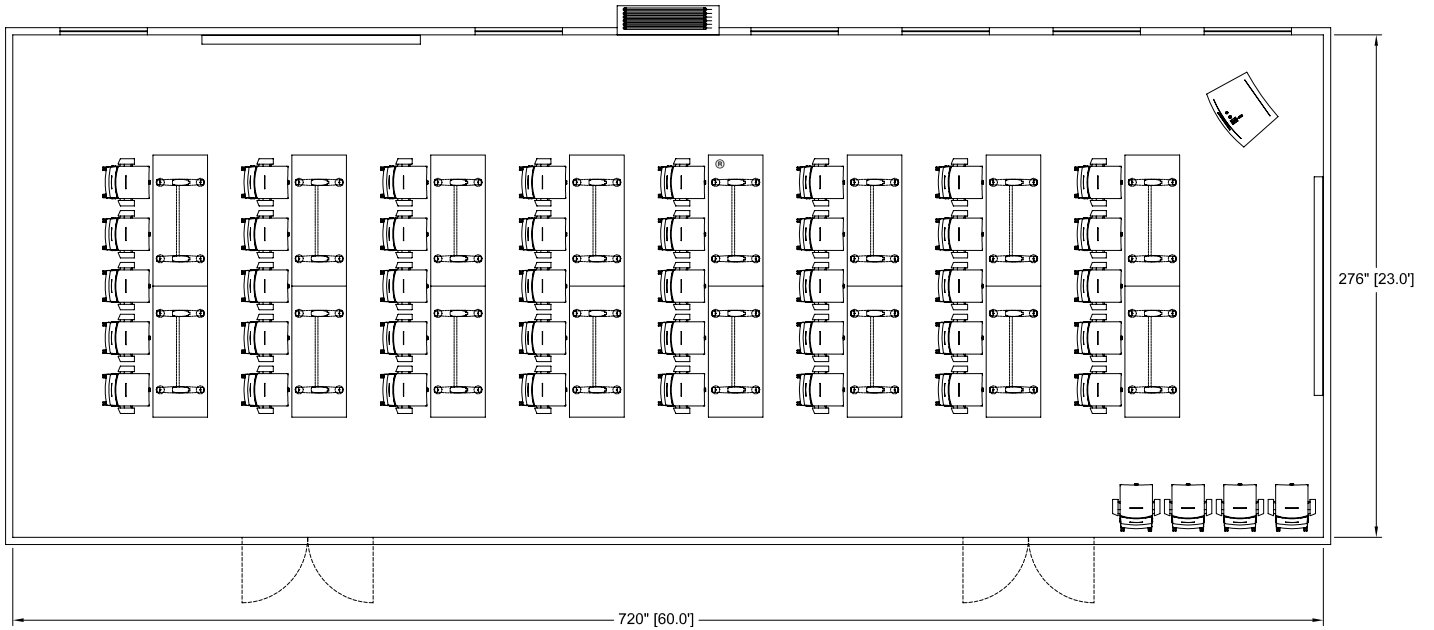

ROOM 1 – LAYOUT C4

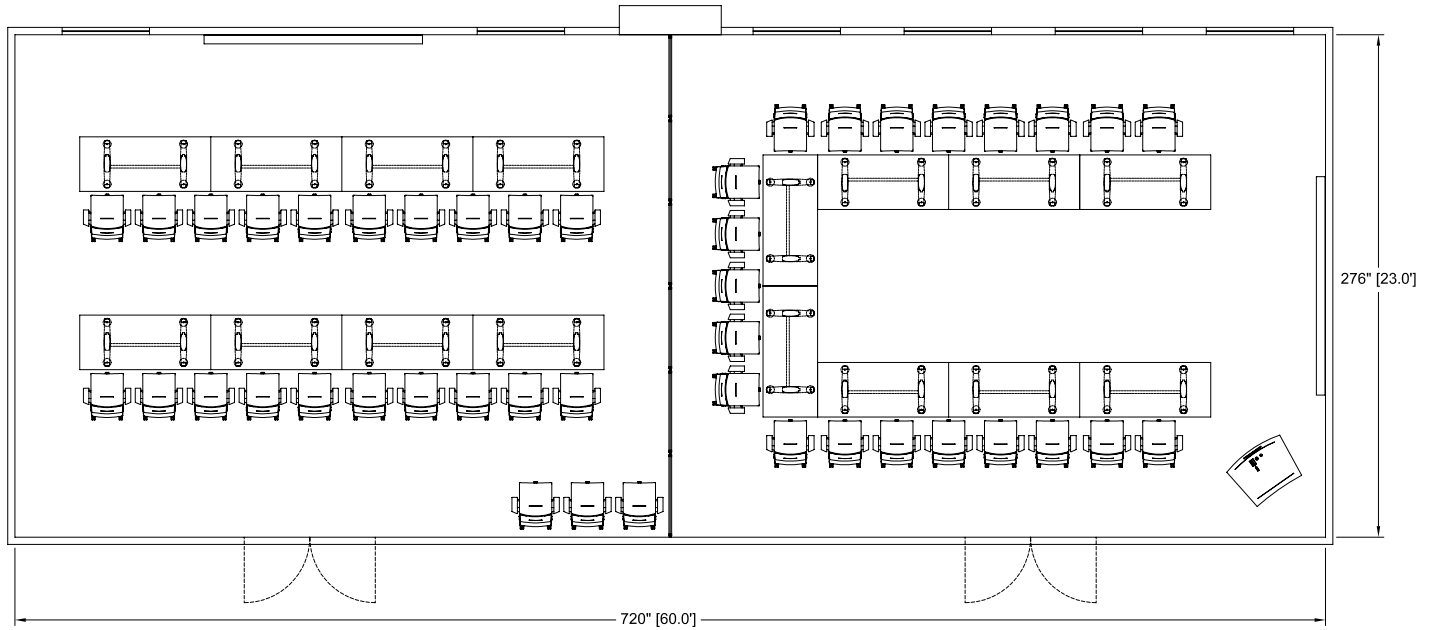

Product Name	Model Number	List Price
16-Vox® FlipTop™ 72" x 30" tables	56430/2	89,835
1-Vox® Presenter's Lectern	23465	12,420
44-NOW® Conference Chairs, with casters	13022	79,260
<b>Total</b>		<b>181,510</b>

# VOX® MEETING ROOM LAYOUTS

Inset Legs Drawings not to scale

ROOM 2 – LAYOUT D1

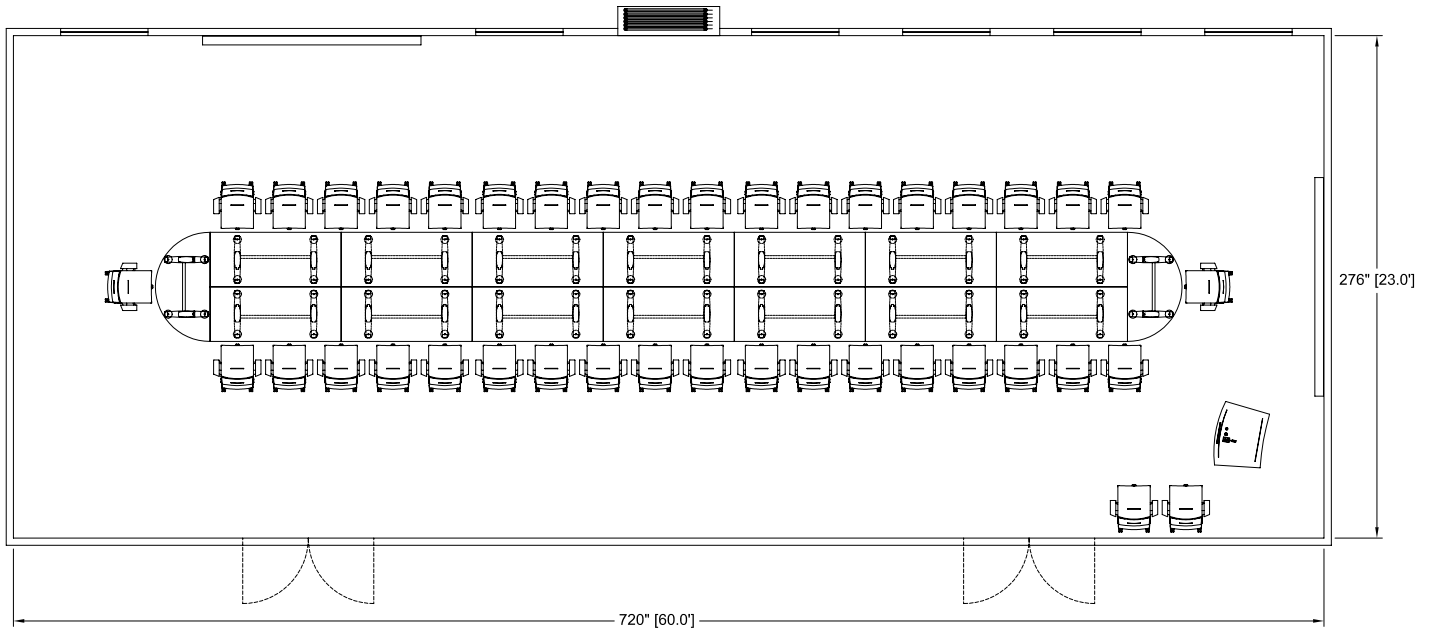

ROOM 2 – LAYOUT D2

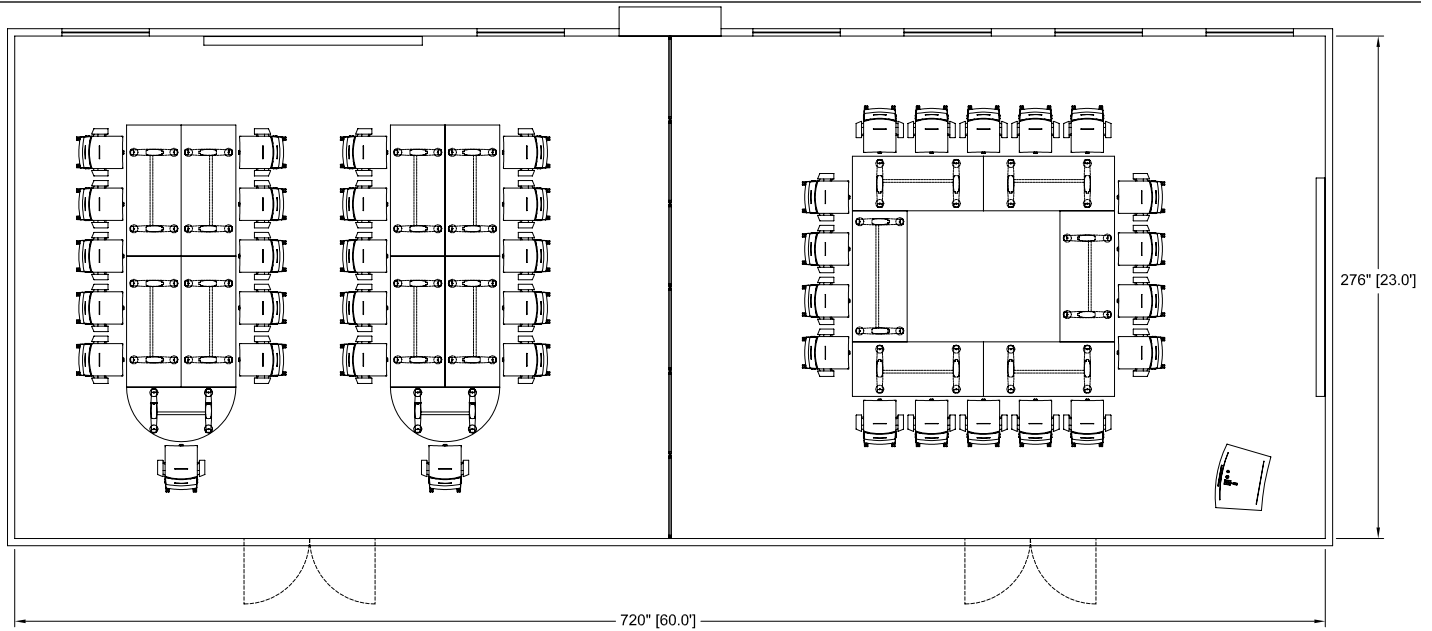

Product Name	Model Number	List Price
14-Vox® FlipTop™ 72" x 30" tables	56430/2	78,610
2-Vox® FlipTop™ Half Round 60" x 30" tables	56171/2	10,595
1-Vox® Presenter's Lectern	23465	12,420
40-NOW® Conference Chairs, with casters	13022	72,060
<b>Total</b>		<b>173,670</b>

# **VOX® FLIPTOP™ CONFERENCE TABLES**

# VOX® FLIPTOP™ CONFERENCE TABLES

## Edge Details Design – Mark Müller

All Vox® FlipTop™ conference tables are available with three edge profiles on user side, to select:

**Facet Edge** add “FC” after the table model number

**Taper Edge** add “TE” after the table model number

**Flowform Edge** add “FF” after the table model number

**Flowform Edge is a 5% upcharge**

Flowform tops are not available with plastic laminate

- All other edges of the top are Self Edged.
- All Vox® FlipTop™ conference table tops are 1/4" thick, edges are manufactured with a solid wood edge that is profiled and then veneer wrapped.

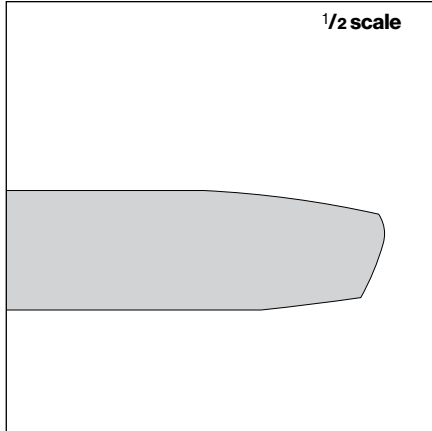
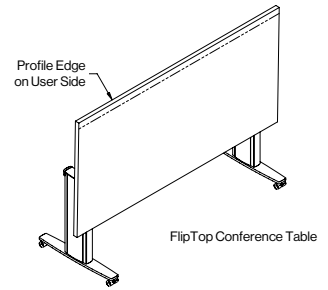

Facet Edge "FC"

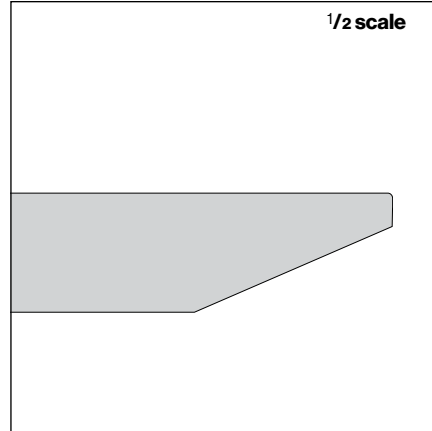

Taper Edge "TE"

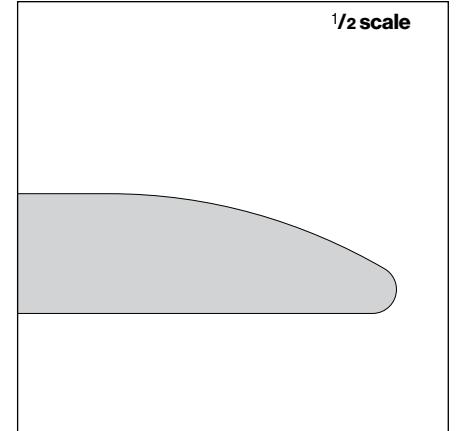

Flowform Edge "FF"



Facet Edge - specify "FC"

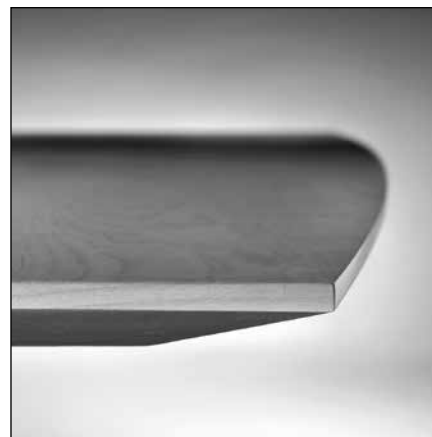

Taper Edge - specify "TE"



Flowform Edge - specify "FF"

# VOX® FLIPTOP™ CONFERENCE TABLES

## Forum Information Design – Mark Müller

Vox® Infill FlipTop™ tables can be specified with Pre-wired “S-Series” Forums in a range of configurations. A rail joining the two table legs acts as a stabilizer for the table and along with wire management clips provide a convenient place to store cables. For complete Vox® Forum details refer to the Vox® Conference™ Price List.

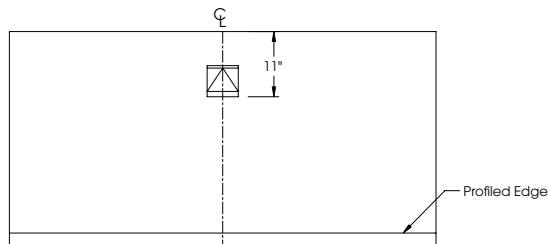

Rectangular Shape

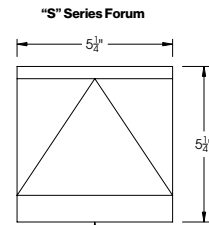

Models A,B,C,G and H

"S" Series Vox® Forums

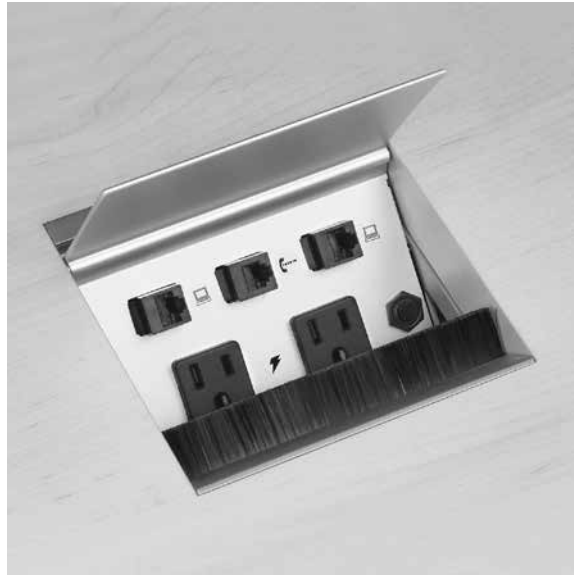

The "S-Series" Forum is available in 2 sizes: 5 1/4" W or 12" W. Fourteen models from A to I with eight data configurations to satisfy most requirements.

# VOX® INFILL FLIPTOP™ TABLES

Used with Conference Tables (Pgs 34 – 35) Design – Mark Müller



Specify edge type; add the two letter code after the model number.

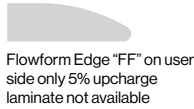
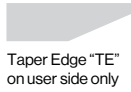
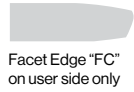

Anodized Finish

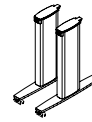

Mirror-polished

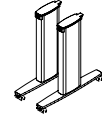

Tops are 1/4" Thick

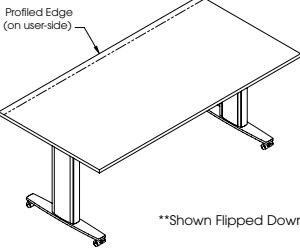

\*\*Shown Flipped Down\*\*

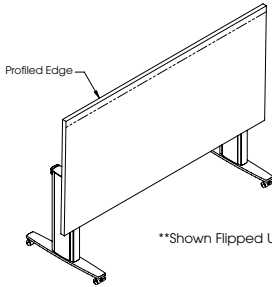

\*\*Shown Flipped Up\*\*

L" x	D" x	H"	Top Finish	Model Number	2 T-Bases	List Price	Model Number	2 T-Bases	List Price
60	24	28½	Wood	56211/2	(2-24")	4,980	56201/2	(2-24")	5,560
<b>60</b>	<b>24</b>	<b>28½</b>	<b>P-Lam</b>	<b>56212/5</b>	<b>(2-24")</b>	<b>4,745</b>	<b>56202/5</b>	<b>(2-24")</b>	<b>5,325</b>
66	24	28½	Wood	56213/2	(2-24")	5,095	56203/2	(2-24")	5,670
<b>66</b>	<b>24</b>	<b>28½</b>	<b>P-Lam</b>	<b>56214/5</b>	<b>(2-24")</b>	<b>4,840</b>	<b>56204/5</b>	<b>(2-24")</b>	<b>5,420</b>
72	24	28½	Wood	56215/2	(2-24")	5,245	56205/2	(2-24")	5,815
<b>72</b>	<b>24</b>	<b>28½</b>	<b>P-Lam</b>	<b>56216/5</b>	<b>(2-24")</b>	<b>4,965</b>	<b>56206/5</b>	<b>(2-24")</b>	<b>5,540</b>
78	24	28½	Wood	56217/2	(2-24")	5,355	56207/2	(2-24")	5,930
<b>78</b>	<b>24</b>	<b>28½</b>	<b>P-Lam</b>	<b>56218/5</b>	<b>(2-24")</b>	<b>5,055</b>	<b>56208/5</b>	<b>(2-24")</b>	<b>5,625</b>
84	24	28½	Wood	56219/2	(2-24")	5,475	56209/2	(2-24")	6,040
<b>84</b>	<b>24</b>	<b>28½</b>	<b>P-Lam</b>	<b>56220/5</b>	<b>(2-24")</b>	<b>5,145</b>	<b>56210/5</b>	<b>(2-24")</b>	<b>5,720</b>
60	27	28½	Wood	56231/2	(2-24")	5,145	56221/2	(2-24")	5,720
<b>60</b>	<b>27</b>	<b>28½</b>	<b>P-Lam</b>	<b>56232/5</b>	<b>(2-24")</b>	<b>4,875</b>	<b>56222/5</b>	<b>(2-24")</b>	<b>5,455</b>
66	27	28½	Wood	56233/2	(2-24")	5,265	56223/2	(2-24")	5,835
<b>66</b>	<b>27</b>	<b>28½</b>	<b>P-Lam</b>	<b>56234/5</b>	<b>(2-24")</b>	<b>4,975</b>	<b>56224/5</b>	<b>(2-24")</b>	<b>5,550</b>
72	27	28½	Wood	56235/2	(2-24")	5,425	56225/2	(2-24")	6,005
<b>72</b>	<b>27</b>	<b>28½</b>	<b>P-Lam</b>	<b>56236/5</b>	<b>(2-24")</b>	<b>5,110</b>	<b>56226/5</b>	<b>(2-24")</b>	<b>5,705</b>
78	27	28½	Wood	56237/2	(2-24")	5,560	56227/2	(2-24")	6,135
<b>78</b>	<b>27</b>	<b>28½</b>	<b>P-Lam</b>	<b>56238/5</b>	<b>(2-24")</b>	<b>5,210</b>	<b>56228/5</b>	<b>(2-24")</b>	<b>5,795</b>
84	27	28½	Wood	56239/2	(2-24")	5,670	56229/2	(2-24")	6,260
<b>84</b>	<b>27</b>	<b>28½</b>	<b>P-Lam</b>	<b>56240/5</b>	<b>(2-24")</b>	<b>5,305</b>	<b>56230/5</b>	<b>(2-24")</b>	<b>5,895</b>
60	30	28½	Wood	56251/2	(2-26")	5,305	56241/2	(2-26")	5,895
<b>60</b>	<b>30</b>	<b>28½</b>	<b>P-Lam</b>	<b>56252/5</b>	<b>(2-26")</b>	<b>5,005</b>	<b>56242/5</b>	<b>(2-26")</b>	<b>5,580</b>
66	30	28½	Wood	56253/2	(2-26")	5,430	56243/2	(2-26")	6,015
<b>66</b>	<b>30</b>	<b>28½</b>	<b>P-Lam</b>	<b>56254/5</b>	<b>(2-26")</b>	<b>5,105</b>	<b>56244/5</b>	<b>(2-26")</b>	<b>5,700</b>
72	30	28½	Wood	56255/2	(2-26")	5,620	56245/2	(2-26")	6,205
<b>72</b>	<b>30</b>	<b>28½</b>	<b>P-Lam</b>	<b>56256/5</b>	<b>(2-26")</b>	<b>5,270</b>	<b>56246/5</b>	<b>(2-26")</b>	<b>5,855</b>
78	30	28½	Wood	56257/2	(2-26")	5,765	56247/2	(2-26")	6,345
<b>78</b>	<b>30</b>	<b>28½</b>	<b>P-Lam</b>	<b>56258/5</b>	<b>(2-26")</b>	<b>5,385</b>	<b>56248/5</b>	<b>(2-26")</b>	<b>5,970</b>
84	30	28½	Wood	56259/2	(2-26")	5,890	56249/2	(2-26")	6,465
<b>84</b>	<b>30</b>	<b>28½</b>	<b>P-Lam</b>	<b>56260/5</b>	<b>(2-26")</b>	<b>5,475</b>	<b>56250/5</b>	<b>(2-26")</b>	<b>6,040</b>
60	33	28½	Wood	56271/2	(2-26")	5,475	56261/2	(2-26")	6,040
<b>60</b>	<b>33</b>	<b>28½</b>	<b>P-Lam</b>	<b>56272/5</b>	<b>(2-26")</b>	<b>5,130</b>	<b>56262/5</b>	<b>(2-26")</b>	<b>5,715</b>
66	33	28½	Wood	56273/2	(2-26")	5,605	56263/2	(2-26")	6,185
<b>66</b>	<b>33</b>	<b>28½</b>	<b>P-Lam</b>	<b>56274/5</b>	<b>(2-26")</b>	<b>5,245</b>	<b>56264/5</b>	<b>(2-26")</b>	<b>5,815</b>
72	33	28½	Wood	56275/2	(2-26")	5,810	56265/2	(2-26")	6,385
<b>72</b>	<b>33</b>	<b>28½</b>	<b>P-Lam</b>	<b>56276/5</b>	<b>(2-26")</b>	<b>5,425</b>	<b>56266/5</b>	<b>(2-26")</b>	<b>6,005</b>
78	33	28½	Wood	56277/2	(2-26")	5,975	56267/2	(2-26")	6,550
<b>78</b>	<b>33</b>	<b>28½</b>	<b>P-Lam</b>	<b>56278/5</b>	<b>(2-26")</b>	<b>5,550</b>	<b>56268/5</b>	<b>(2-26")</b>	<b>6,125</b>
84	33	28½	Wood	56279/2	(2-26")	6,090	56269/2	(2-26")	6,670
<b>84</b>	<b>33</b>	<b>28½</b>	<b>P-Lam</b>	<b>56280/5</b>	<b>(2-26")</b>	<b>5,625</b>	<b>56270/5</b>	<b>(2-26")</b>	<b>6,210</b>
60	36	28½	Wood	56291/2	(2-26")	5,625	56281/2	(2-26")	6,210
<b>60</b>	<b>36</b>	<b>28½</b>	<b>P-Lam</b>	<b>56292/5</b>	<b>(2-26")</b>	<b>5,265</b>	<b>56282/5</b>	<b>(2-26")</b>	<b>5,835</b>
66	36	28½	Wood	56293/2	(2-26")	5,785	56283/2	(2-26")	6,355
<b>66</b>	<b>36</b>	<b>28½</b>	<b>P-Lam</b>	<b>56294/5</b>	<b>(2-26")</b>	<b>5,375</b>	<b>56284/5</b>	<b>(2-26")</b>	<b>5,955</b>
72	36	28½	Wood	56295/2	(2-26")	6,005	56285/2	(2-26")	6,580
<b>72</b>	<b>36</b>	<b>28½</b>	<b>P-Lam</b>	<b>56296/5</b>	<b>(2-26")</b>	<b>5,580</b>	<b>56286/5</b>	<b>(2-26")</b>	<b>6,165</b>
78	36	28½	Wood	56297/2	(2-26")	6,185	56287/2	(2-26")	6,755
<b>78</b>	<b>36</b>	<b>28½</b>	<b>P-Lam</b>	<b>56298/5</b>	<b>(2-26")</b>	<b>5,720</b>	<b>56288/5</b>	<b>(2-26")</b>	<b>6,300</b>
84	36	28½	Wood	56299/2	(2-26")	6,285	56289/2	(2-26")	6,875
<b>84</b>	<b>36</b>	<b>28½</b>	<b>P-Lam</b>	<b>56300/5</b>	<b>(2-26")</b>	<b>5,795</b>	<b>56290/5</b>	<b>(2-26")</b>	<b>6,370</b>

# VOX® CONFERENCE TABLES

Used with Infill FlipTop™ Tables (Pgs 33) Design – Mark Müller



Specify edge type; add the two letter code after the model number.

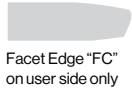

Facet Edge "FC"  
on user side only

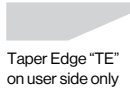

Taper Edge "TE"  
on user side only



Flowform Edge "FF"  
on user side only  
5% upcharge  
laminates not available

Anodized Finish

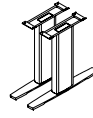

Mirror-polished

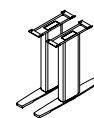

Tops are 1¼" Thick

\* Based on a chair width of 25"

L" x D"	Sugg Seat Capacity*	Top Finish	Top Sections	Model Number	2 T-Bases	List Price	Model Number	2 T-Bases	List Price
96 48	6-8	Wood	1	56341/2	(2-28")	8,415	56301/2	(2-28")	10,175
<b>96 48</b>	<b>6-8</b>	<b>P-Lam</b>	<b>1</b>	<b>56342/5</b>	<b>(2-28")</b>	<b>6,925</b>	<b>56302/5</b>	<b>(2-28")</b>	<b>8,690</b>
108 48	8-10	Wood	1	56343/2	(2-28")	9,190	56303/2	(2-28")	10,945
<b>108 48</b>	<b>8-10</b>	<b>P-Lam</b>	<b>1</b>	<b>56344/5</b>	<b>(2-28")</b>	<b>7,530</b>	<b>56304/5</b>	<b>(2-28")</b>	<b>9,275</b>
120 48	8-10	Wood	2	56345/2	(2-28")	10,840	56305/2	(2-28")	12,595
120 48	8-10	P-Lam	2	56346/5	(2-28")	8,990	56306/5	(2-28")	10,750
120 54	8-10	Wood	2	56347/2	(2-30")	12,170	56307/2	(2-30")	14,045
<b>132 48</b>	<b>8-10</b>	<b>P-Lam</b>	<b>2</b>	<b>56348/2</b>	<b>(2-28")</b>	<b>11,910</b>	<b>56308/2</b>	<b>(2-28")</b>	<b>13,650</b>
132 54	8-10	Wood	2	56349/2	(2-30")	13,245	56309/2	(2-30")	15,095

These models are constructed without support rails – bases are attached directly to tops.

Anodized Finish

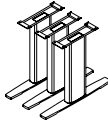

Mirror-polished

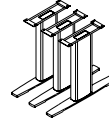

Tops are 1¼" Thick

\* Based on a chair width of 25"

L" x D"	Sugg Seat Capacity*	Top Finish	Top Sections	Model Number	2 T-Bases	List Price	Model Number	2 T-Bases	List Price
144 48	10-12	Wood	2	56350/2	(3-28")	13,910	56310/2	(3-28")	16,535
<b>144 54</b>	<b>10-12</b>	<b>Wood</b>	<b>2</b>	<b>56351/2</b>	<b>(3-30")</b>	<b>15,495</b>	<b>56311/2</b>	<b>(3-30")</b>	<b>18,320</b>
144 60	10-12	Wood	2	56352/2	(3-32")	16,740	56312/2	(3-32")	19,580
<b>156 48</b>	<b>10-12</b>	<b>Wood</b>	<b>2</b>	<b>56353/2</b>	<b>(3-28")</b>	<b>14,940</b>	<b>56313/2</b>	<b>(3-28")</b>	<b>17,580</b>
156 54	12-14	Wood	2	56354/2	(3-30")	16,645	56314/2	(3-30")	19,465
<b>156 60</b>	<b>12-14</b>	<b>Wood</b>	<b>2</b>	<b>56355/2</b>	<b>(3-32")</b>	<b>18,040</b>	<b>56315/2</b>	<b>(3-32")</b>	<b>20,885</b>
156 66	12-14	Wood	2	56356/2	(3-34")	19,395	56316/2	(3-34")	22,365
<b>168 48</b>	<b>12-14</b>	<b>Wood</b>	<b>2</b>	<b>56357/2</b>	<b>(3-28")</b>	<b>16,790</b>	<b>56317/2</b>	<b>(3-28")</b>	<b>19,435</b>
168 54	12-14	Wood	2	56358/2	(3-30")	18,645	56318/2	(3-30")	21,460
<b>168 60</b>	<b>12-14</b>	<b>Wood</b>	<b>2</b>	<b>56359/2</b>	<b>(3-32")</b>	<b>20,160</b>	<b>56319/2</b>	<b>(3-32")</b>	<b>22,995</b>
168 66	12-14	Wood	2	56360/2	(3-34")	21,645	56320/2	(3-34")	24,640
<b>180 48</b>	<b>12-14</b>	<b>Wood</b>	<b>3</b>	<b>56361/2</b>	<b>(3-28")</b>	<b>17,615</b>	<b>56321/2</b>	<b>(3-28")</b>	<b>20,260</b>
180 60	14-16	Wood	3	56362/2	(3-30")	21,190	56322/2	(3-30")	24,030
<b>180 66</b>	<b>14-16</b>	<b>Wood</b>	<b>3</b>	<b>56363/2</b>	<b>(3-32")</b>	<b>22,780</b>	<b>56323/2</b>	<b>(3-32")</b>	<b>25,770</b>
180 72	14-16	Wood	3	56364/2	(3-34")	24,770	56324/2	(3-34")	28,090

## TABLE DIMENSIONING LAYOUT

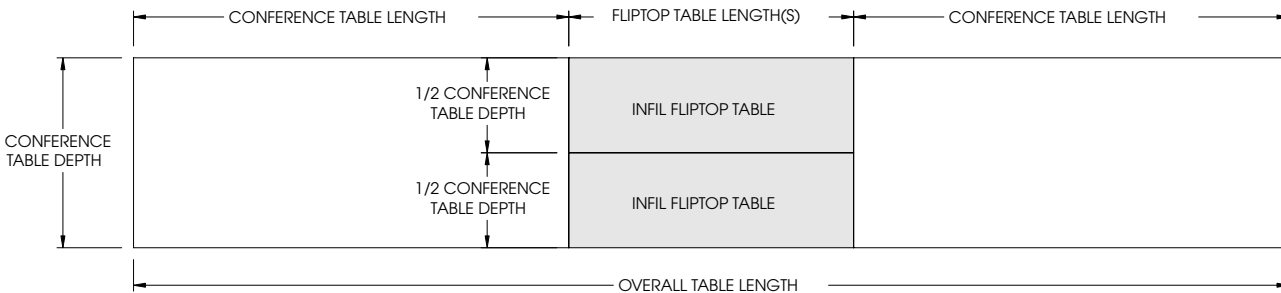



# VOX® CONFERENCE TABLES

Used with Infill FlipTop™ Tables (Pgs 33) Design – Mark Müller

Specify edge type; add the two letter code after the model number.

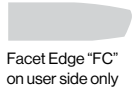

Facet Edge "FC"  
on user side only

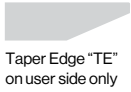

Taper Edge "TE"  
on user side only



Flowform Edge "FF"  
on user side only  
5% upcharge  
laminates not available

Anodized Finish

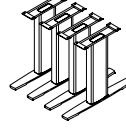

Mirror-polished

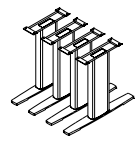

Tops are 1¼" Thick

\* Based on a chair width of 25".

L" x D"	Sugg Seat Capacity*	Top Finish	Top Sections	Model Number	4 T-Bases	List Price	Model Number	4 T-Bases	List Price
192 54	14-16	Wood	4	56365/2	(3-30")	22,315	56325/2	(3-30")	26,080
192 60	14-16	Wood	4	56366/2	(3-32")	24,125	56326/2	(3-32")	27,930
192 66	14-16	Wood	4	56367/2	(3-34")	25,895	56327/2	(3-34")	29,890
192 72	14-16	Wood	4	56368/2	(3-36")	28,190	56328/2	(3-36")	32,605
204 54	14-16	Wood	4	56369/2	(3-30")	23,260	56329/2	(3-30")	27,035
204 60	16-18	Wood	4	56370/2	(3-32")	25,195	56330/2	(3-32")	29,000
204 66	16-18	Wood	4	56371/2	(3-34")	27,080	56331/2	(3-34")	31,060
204 72	16-18	Wood	4	56372/2	(3-36")	29,460	56332/2	(3-36")	33,875
216 54	16-18	Wood	4	56373/2	(3-30")	24,940	56333/2	(3-30")	28,700
216 60	16-18	Wood	4	56374/2	(3-32")	27,025	56334/2	(3-32")	30,815
216 66	16-18	Wood	4	56375/2	(3-34")	29,075	56335/2	(3-34")	33,040
216 72	16-18	Wood	4	56376/2	(3-36")	31,605	56336/2	(3-36")	36,050
228 54	16-18	Wood	4	56377/2	(3-30")	26,115	56337/2	(3-30")	29,880
228 60	16-18	Wood	4	56378/2	(3-32")	28,345	56338/2	(3-32")	32,130
228 66	18-20	Wood	4	56379/2	(3-34")	31,230	56339/2	(3-34")	35,185
228 72	18-20	Wood	4	56380/2	(3-36")	33,210	56340/2	(3-36")	37,620

## EDGE PROFILING

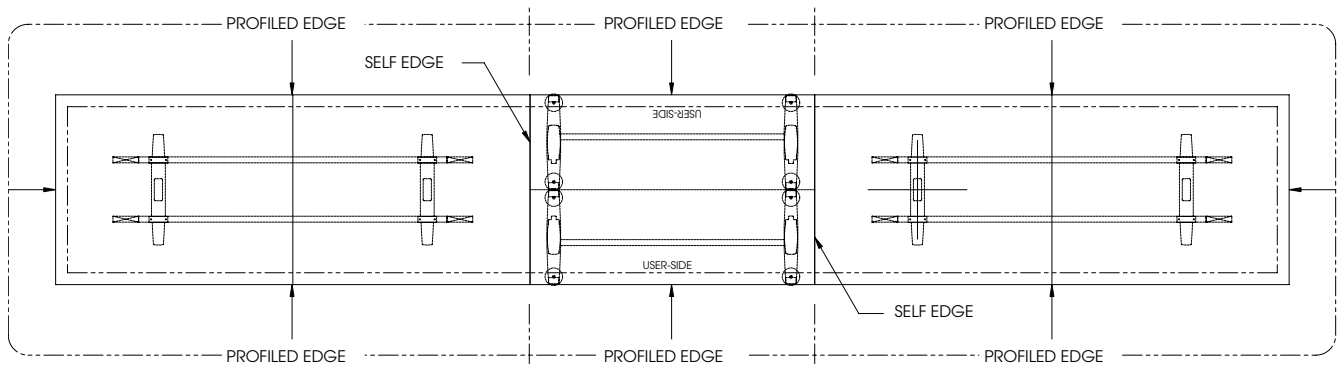

# VOX® CONFERENCE ROOM LAYOUTS

DRAWINGS NOT TO SCALE

## ROOM 3 – LAYOUT A1: LARGE BOARDROOM INTEGRATION

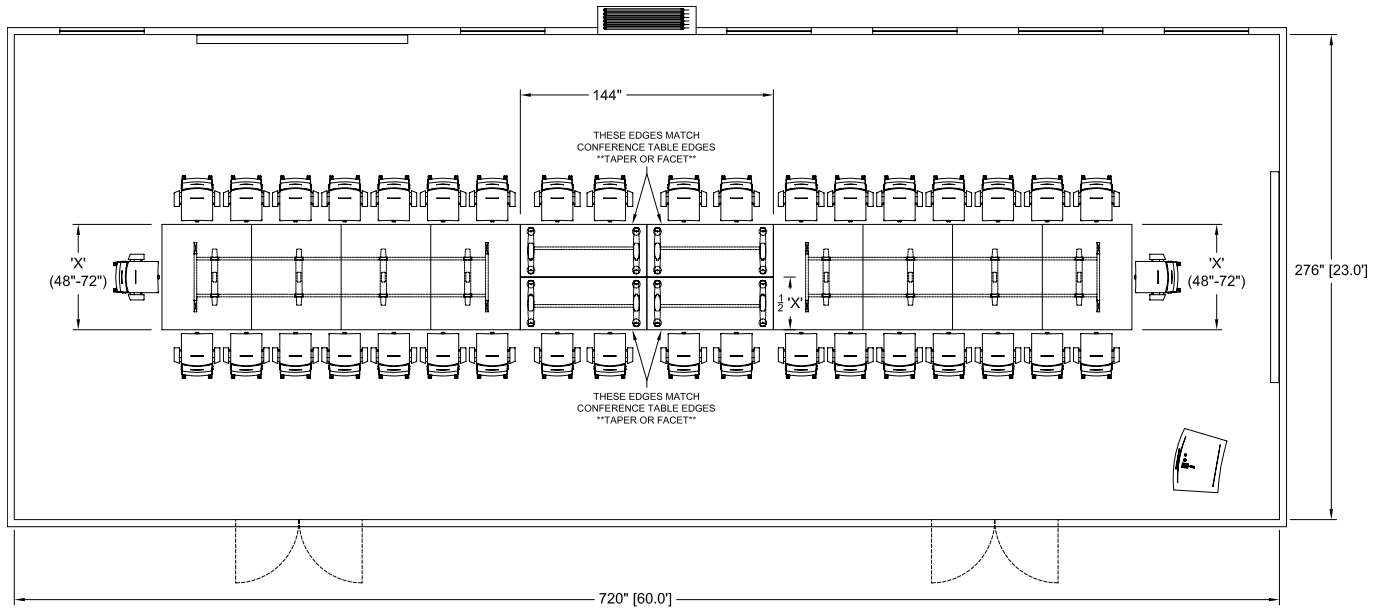

## ROOM 3 – LAYOUT A2

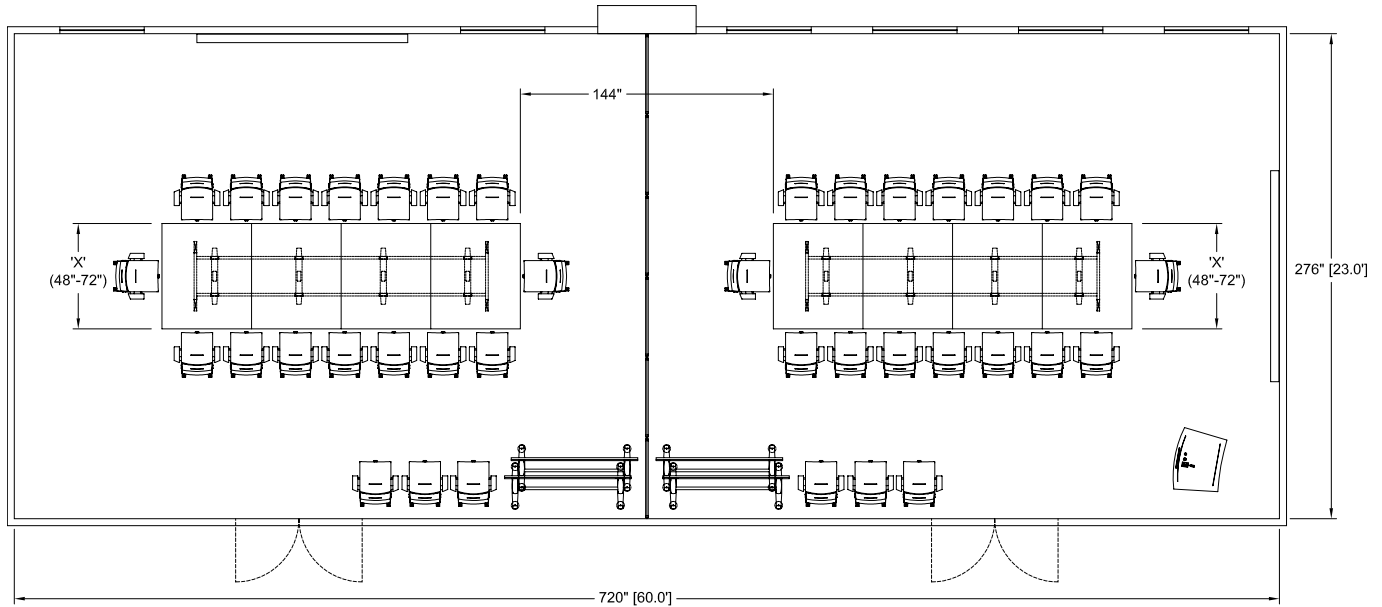

Product Name	Model Number	List Price
4-Vox® FlipTop™ 72" x 30" tables	56255/2	22,465
2-Vox® Rectangle Shape Conference tables, 204" x 60", with T-Bases	51435/2	57,990
1-Vox® Presenter's Lectern	23465	12,420
38-NOW® Conference Chairs, with casters	13022	68,455
Total		161,325

# VOX® CONFERENCE ROOM LAYOUTS

DRAWINGS NOT TO SCALE

## ROOM 4 – LAYOUT B1: SMALL BOARDROOM INTEGRATION

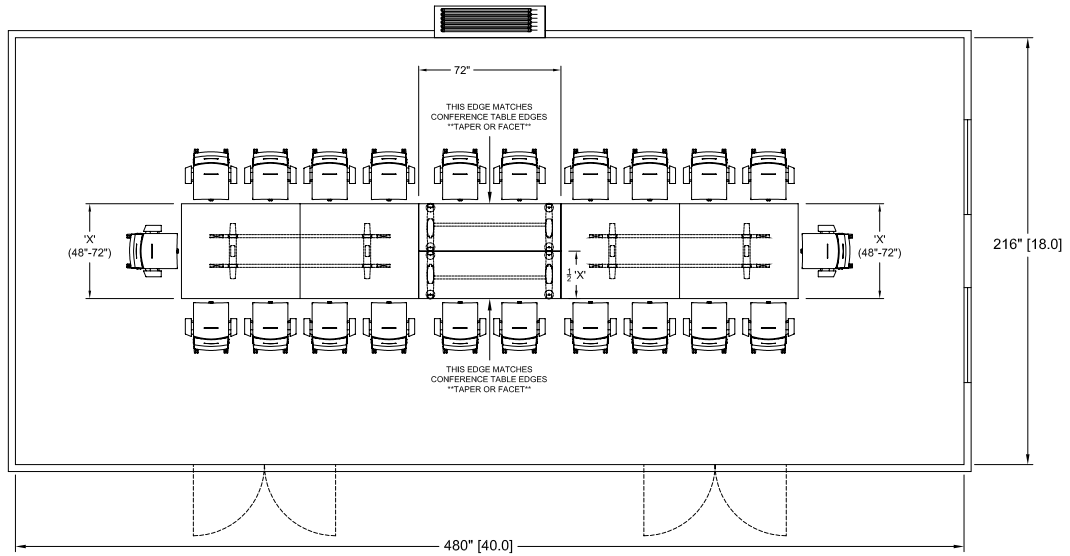

## ROOM 4 – LAYOUT B2

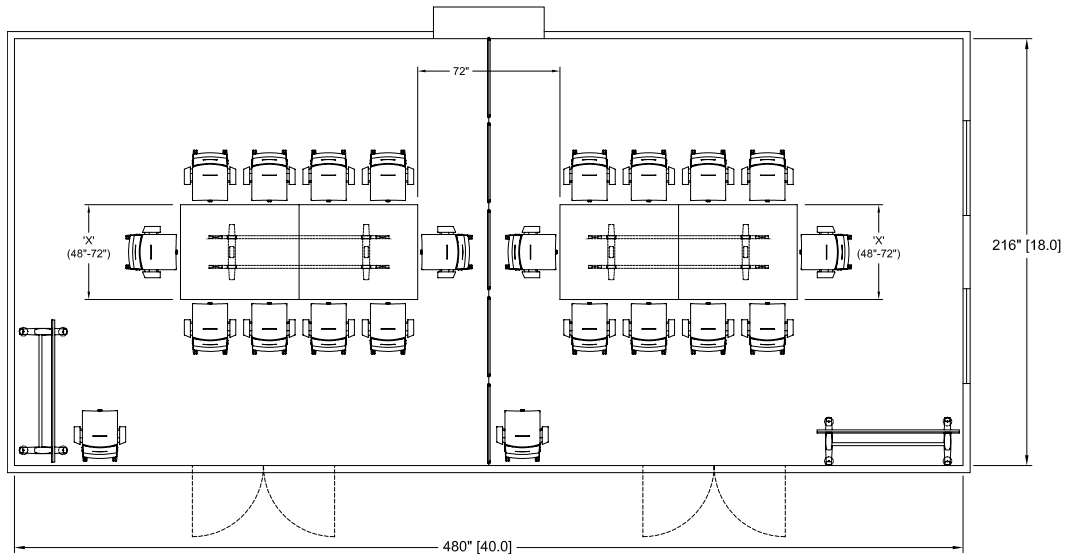

Product Name	Model Number	List Price
2-Vox® FlipTop™ 72" x 24" tables	56215/2	10,490
2-Vox® Rectangle Shape Conference tables, 120" x 48", with T-Bases	51410/2	25,185
22-NOW® Conference Chairs, with casters	13022	39,640
<b>Total</b>		<b>75,315</b>

# TERMS AND CONDITIONS OF SALE

---

## PRICES

All prices are list prices, freight included, blanket-wrapped, dock delivered, from the manufacturing source to any location in the contiguous United States.

Brokerage is paid by Nienkämper for product shipped to the United States.

Due to existing conditions in regard to cost of labor and materials, we reserve the right to change prices without notice.

## TERMS

Net 30 days from date of invoice to accredited buyers. Two per cent (2%) interest charged monthly on overdue accounts. Deposit of 50% is required with order. Terms will be established upon credit evaluation. Due to delays in processing references, first orders may be treated as C.B.D. orders.

## ORDER CONFIRMATION

Orders are accepted upon issuance of our order confirmation and are subject to the terms set forth therein; notwithstanding any variance from the terms of the buyer's order form.

Nienkämper is not liable for any delay or failure to deliver caused by labor or transportation difficulties, accidents, acts of God, failure of sources of supply, or other causes beyond our control, and changes will affect the delivery date.

## CHANGE OF ORDERS OR CANCELLATIONS

Changes or cancellations are subject to our ability to conform. A charge will be levied against canceled or changed orders based on costs already incurred by Nienkämper. All changes must be in writing and submitted on a revised purchase order. Changes will affect the delivery date.

## STORAGE

If goods cannot be accepted when ready, we may transfer them to storage (which is to be deemed as delivery for invoice purposes). The customer accepts risks and will be charged at prevailing rates.

## FREIGHT

Prices include freight charges, blanket-wrapped, dock delivered, from the manufacturing source to any location in the contiguous United States. Packing and/or crating are available, if required, upcharges apply.

## CLAIMS

All furniture is given to the carrier and signed for in good condition. It is the responsibility of the receiver to sign for the goods in the presence of the carrier and note the condition in which they are received. Freight claims should be filed with the carrier.

## WARRANTY

There are no express or implied warranties, conditions and obligations of the manufacturer, whether statutory or otherwise that extend beyond the description on the face hereof. Our furniture is made to the highest standard and is warranted free from defects of material and workmanship for five years from the date of delivery. During the warranty period we will repair or replace such merchandise as shall prove to be defective, during normal usage in accordance with manufacturer's specifications. The manufacturer shall not be liable for defect wholly attributable to normal manufacturing process. Replacement or repair of the Product shall be the sole remedy of the Customer, and the manufacturer shall not be liable for any direct, indirect, incidental, or consequential loss or damage suffered by the Customer by reason of any defect in workmanship or manufacture of the Product or inability to use the Product. Moreover, this warranty does not cover accidental damage, abuse, alteration, ordinary wear and tear of Goods, negligence and misuse nor variations over which we have no control such as heat or humidity or damage to which the Goods are connected that is not attributable to the failure of the goods themselves. This warranty is null and void when the product is installed with hardware other than that supplied and/or when installed differently than recommended in the installation guide. Modification to the product or hardware may result in failure of the product and cause damage and/or injury.

## WOOD FINISHES

Nienkämper offers a wide variety of standard light finishes on cherry, mahogany and figured anagré wood veneers, and a clear natural finish on figured anagré, figured sycamore, maple, bird's eye maple and curly maple.

Light finishes do not mask the grain and other characteristics of each wood species. It is important to understand that pieces of the same type of wood will not look identical when a light finish is used. The appearance of the finish will also depend on the natural color of the veneer. Cherry darkens over time as the wood ages. Pin knots and gum pockets are inherent traits.

Wood is a naturally variable raw material; its variances are not within the furniture manufacturer's control and are therefore not considered defects under this warranty.

