

CATALOGUE

FACADE CLADDING



Parklex[®]



For further information:

Sofian Aguelmous — Managing Director
e. sofian@industriarc.com
m. 0411 447 837 | f. 02 9571 9541
w. industriarc.com
p. Suite 2.05/55 Miller Street, Pyrmont NSW 2009



CATALOGUE

FACADE CLADDING

Parklex[®]



Facade is a laminated wood board for exteriors that requires zero maintenance.

The panels combine the virtues of wood, its natural warmth and beauty, with technical requirements to ensure optimum performance on exteriors over time.

Facade can be installed as a ventilated façade by way of louvres or overlapping slats, on false ceilings and on curved walls.

Product: Facade / Wood: Copper
Sutton Offices in Magog (Quebec, Canada)

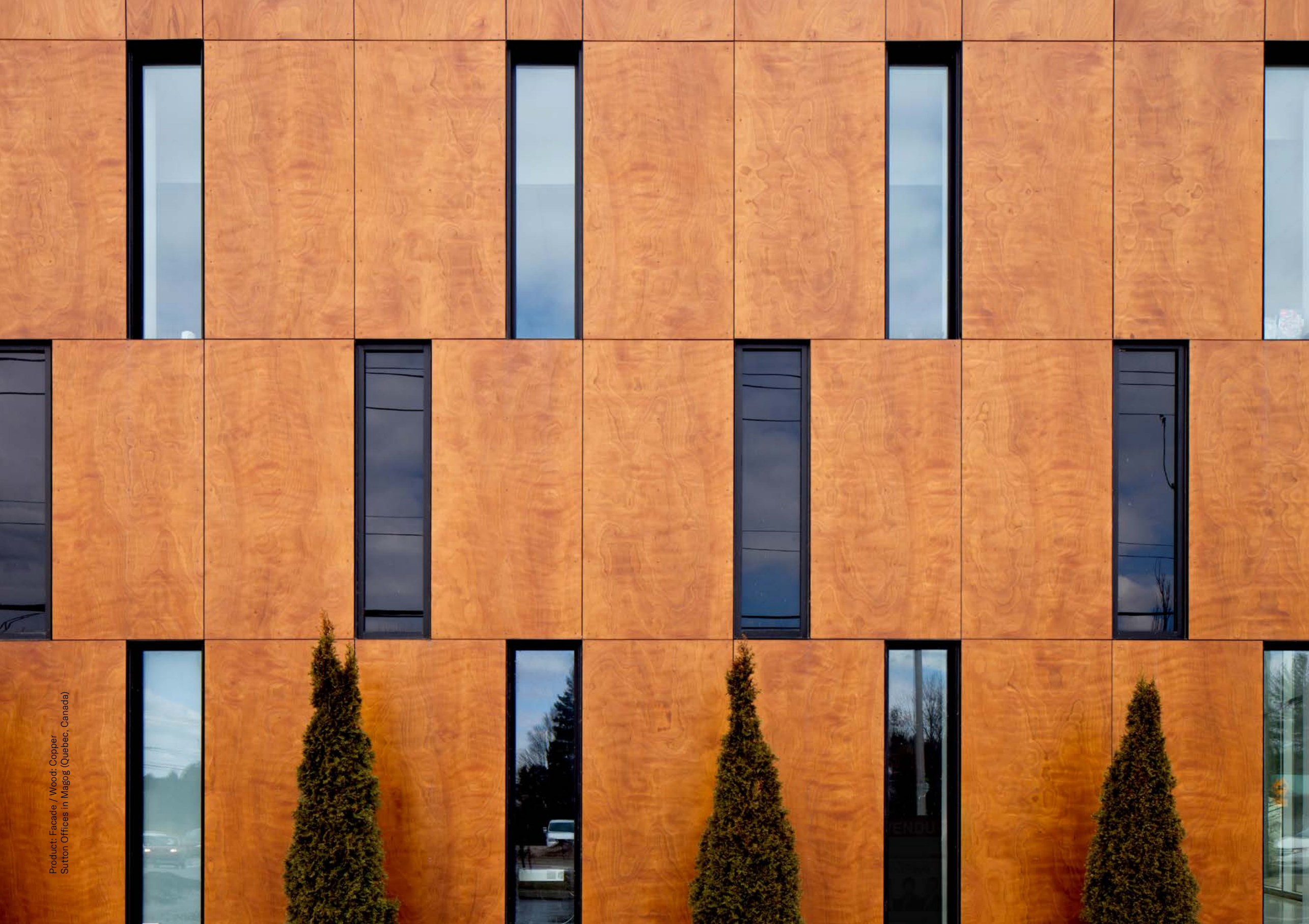

Zero maintenance wood

The surface composition of the Facade boards protects the wood from the most extreme weather conditions, removing any need for subsequent treatment.

Weather resistance

The EN 438-6:2005 European standard specifies that compact exterior cladding such as Facade must offer a certain resistance to weather according to the Resistance to Artificial Weathering Test. After 3000 hours of exposure, the material should have a rating variation of ≥ 4 in appearance, and a rating of ≥ 3 in contrast. Facade attains these values following exposure of up to 5 times greater than regulatory requirements.

Fire safety

The basic safety requirements reduce the risk of damage caused by accidental fire due to the characteristics of the project, construction, use and maintenance of the building to acceptable limits. Facade has achieved the best possible result for organic materials under regulations EN 13501 and US ASTM/NFPA for reaction to fire, which means that our products are approved all over the world.

Installation versatility

Facade can be installed as a ventilated façade by way of louvres or overlapping slats, on false ceilings and on curved walls. It has four different installation systems, which makes them easily adaptable to any kind of architectural requirement.





Product: Facade / Woods (from left to right): Gold, Onyx, Copper
Residences in Pacific City, by MVE Architects (Huntington Beach, CA, USA)





Product: Façade / Wood: Copper
Residences in Pacific City, by MVE Architects
(Huntington Beach, CA, USA)

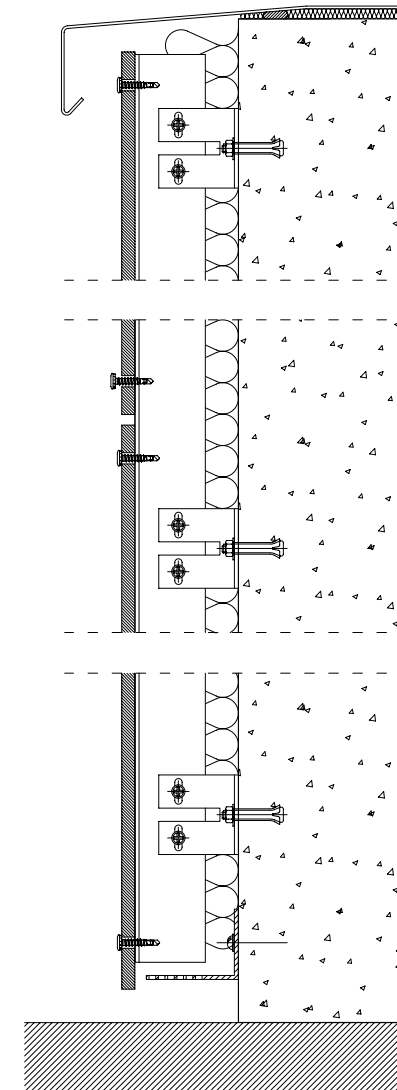

The ventilated façade is an efficient bioclimatic architecture solution that provides thermal insulation. In other words, it reduces heat dissipation in the cold months and heat absorption in the warmer months, resulting in a marked improvement in comfort inside the building.



Product: Facade / Wood: Onix
Manning Toronto, by Richard Wengle Architects Inc. (Toronto, ON, Canada)





Product: Facade / Wood: Copper
Lazaridis Hall, Wilfrid Laurier University, by Diamond Schmitt Architects
with David Thompson Architect Ltd. (Waterloo, Ontario, Canada)



Product: Facade / Wood: Quartz
Turnagain Beach House Anchorage, by KPB Architects (Alaska, AK, USA)





Product: Facade / Wood: Copper
The Point, Tadley Community Centre, by Ayre Chamberlain
Gaunt Architects (Hampshire, UK)



Product: Facade / Wood: Copper
Residence in Varese, by Franzetti Primi Architetti Associati (Varese, Italy)

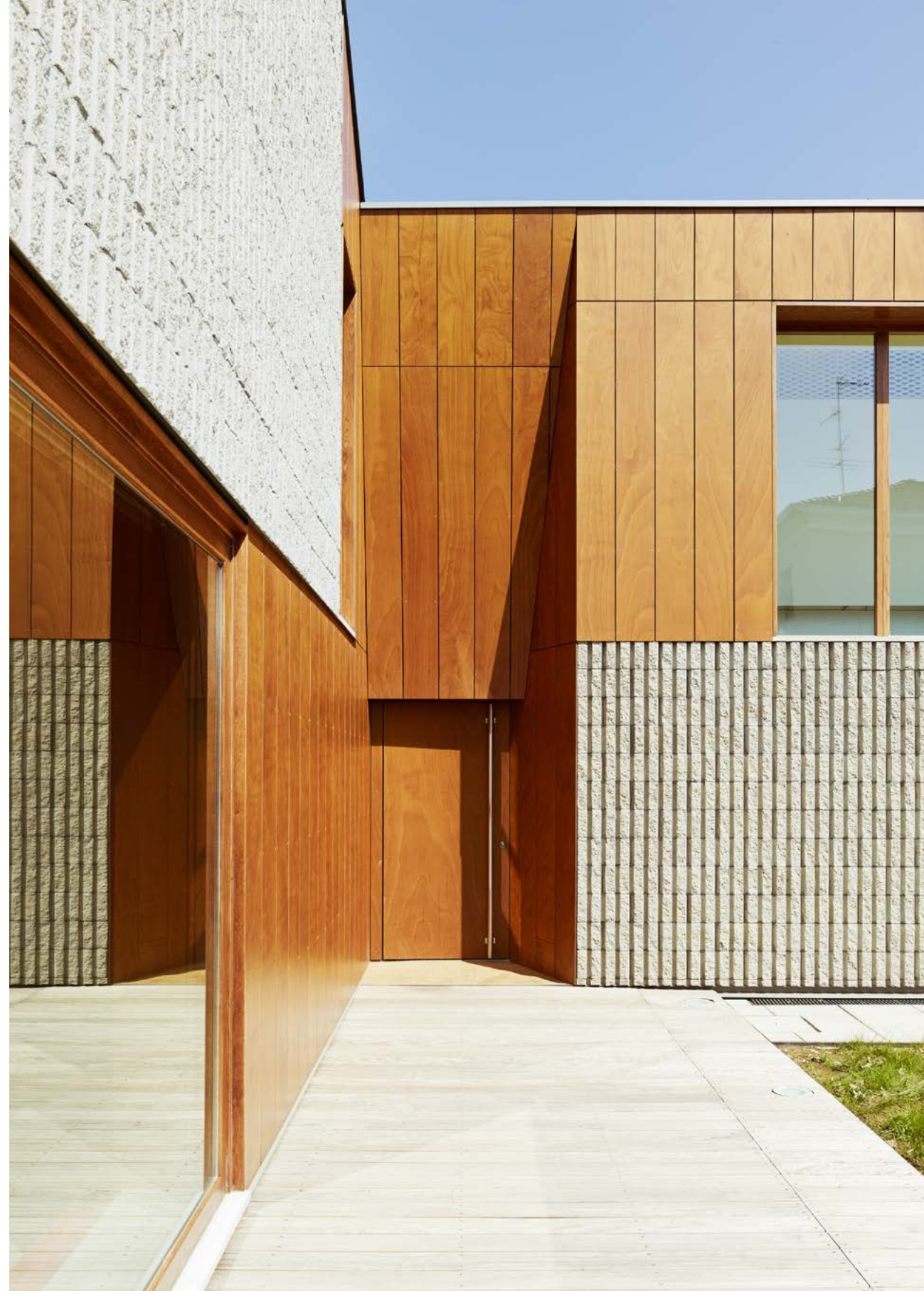



Product: Facade / Wood: Copper
Residence in Varese, by Franzetti Primi Architetti Associati (Varese, Italy)



Product: Facade / Wood: Copper
Residences in Rue des Orteaux, by Bob361 Architectes (Paris, France)



Product: Facade / Wood: Copper
Rainbow Group Headquarters, by Studio Bianchi
(Loreto, Ancona, Italy)





Product: Facade / Woods: Copper and Antra
Gateway Apartments, by Brooks+Scarpa Architects (Marina Del Rey, CA, USA)



The Facade panels are available in nine shades that are obtained through ayous or okume veneer, which we get from forests that respect controlled felling.



AMBAR



ANTRA



BRONZE

Due to the fact that wood is a natural product, each veneer must be considered as unique. The presence of slight differences in colour and structure is normal. Peculiarities such as knots or resin inclusions are not considered to be defects, but as part of the decoration. Depending on the species and the source of the wood, differences in performance may be observed, as regards the colour's light fastness. For this reason, no claims will be admitted on the basis of changes in tone between the sample and the end product.



COPPER



QUARTZ



GOLD



RUBI



ONIX



SILVER

Product: Facade / Wood: Copper
Le Monastère des Augustines, by ABCP
Architecture (Quebec, Canada)

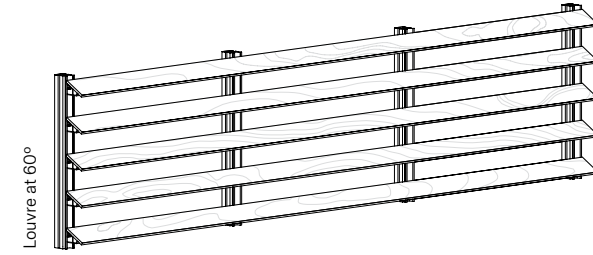
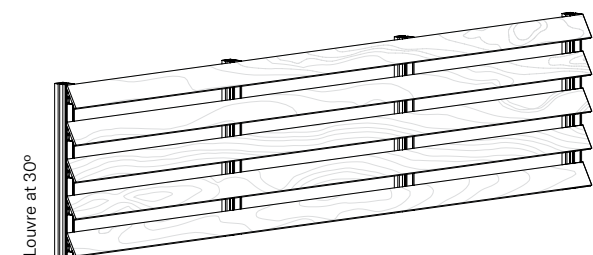
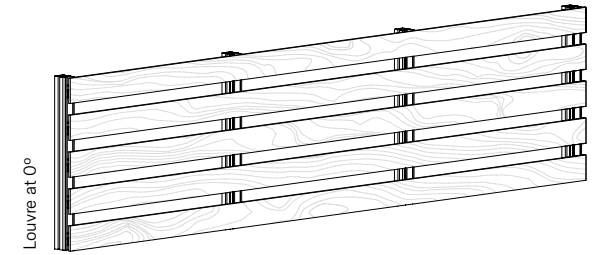

The Facade installation system in fixed louvre mode enables slats to be installed at 0°, 30° and 60°, both horizontally and vertically.

Valid for boards with a thickness of ≥ 10 mm. Parklex® supplies the slats in three different widths: 86, 94 and 114 mm, with a maximum slat length of 2440 mm.



Product: Facade, Dry Internal / Wood: Copper
Le Monastère des Augustines, by ABCP
Architecture (Quebec, Canada)

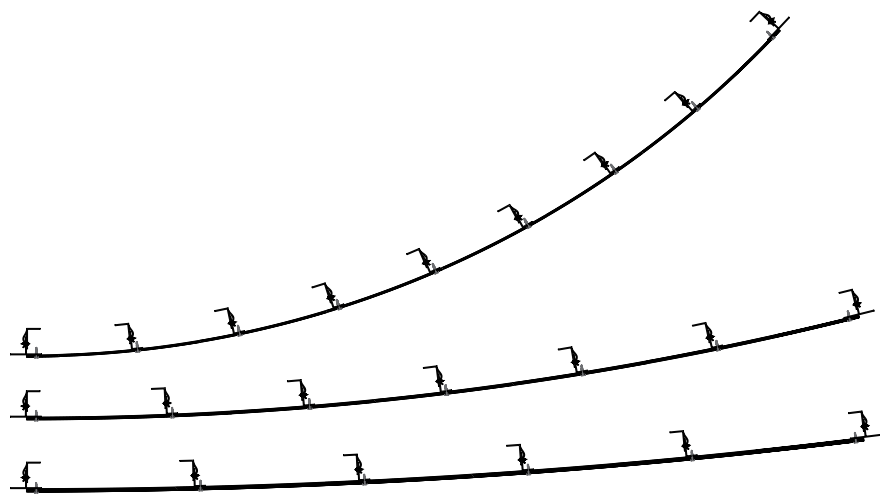

The flexibility of the wood fibres allows the Facade panels to adapt to certain radii of curvature, whether concave or convex.

Parklex® offers two different solutions for projects that require Facade to be installed as a curved façade cladding: either standard panels, if radii above 3 m are required; or pre-bent panels, if smaller radii are required.



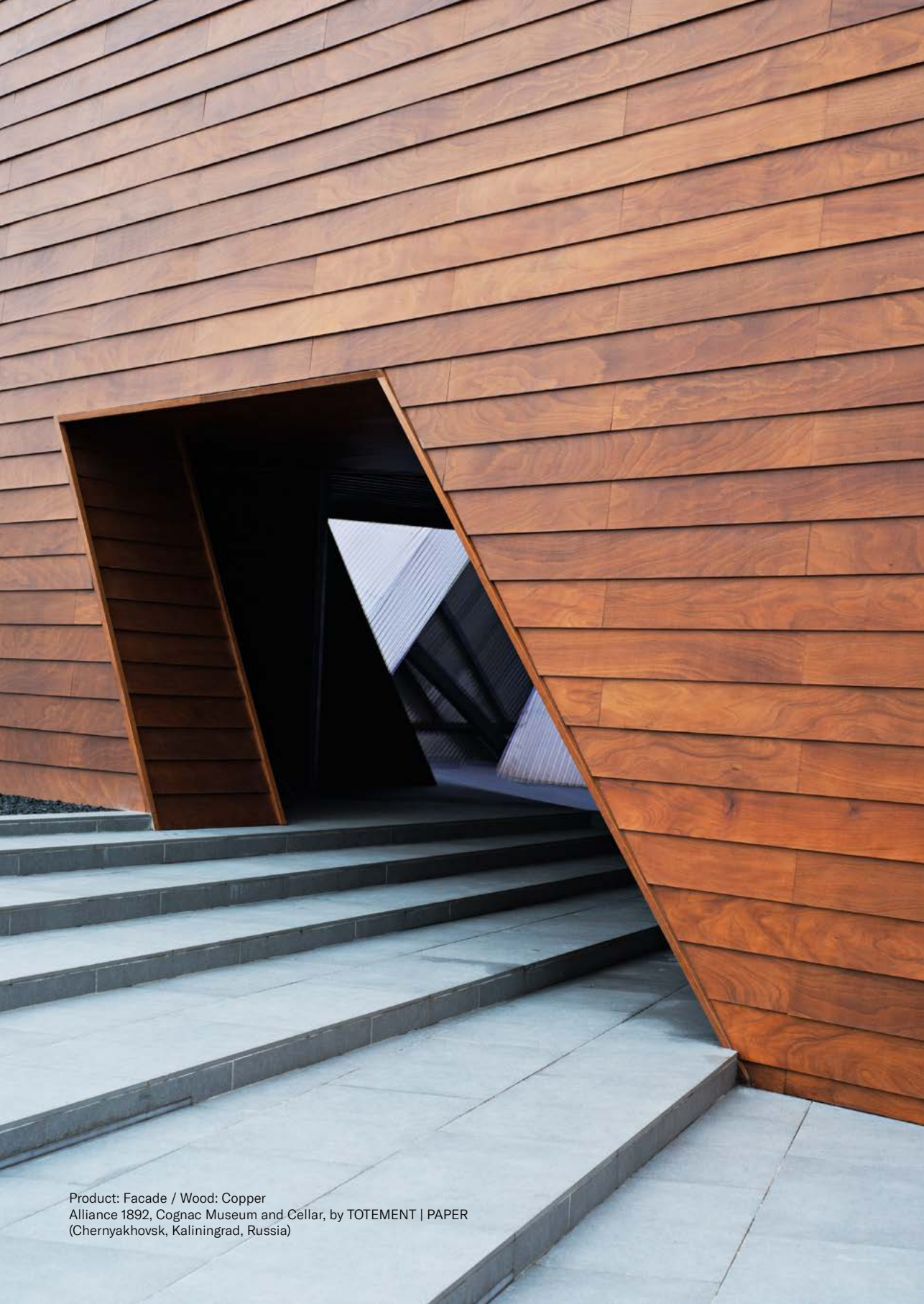

Product: Facade / Wood: Copper
Alliance 1892, Cognac Museum and Cellar, by TOTEMENT | PAPER
(Chernyakhovsk, Kaliningrad, Russia)

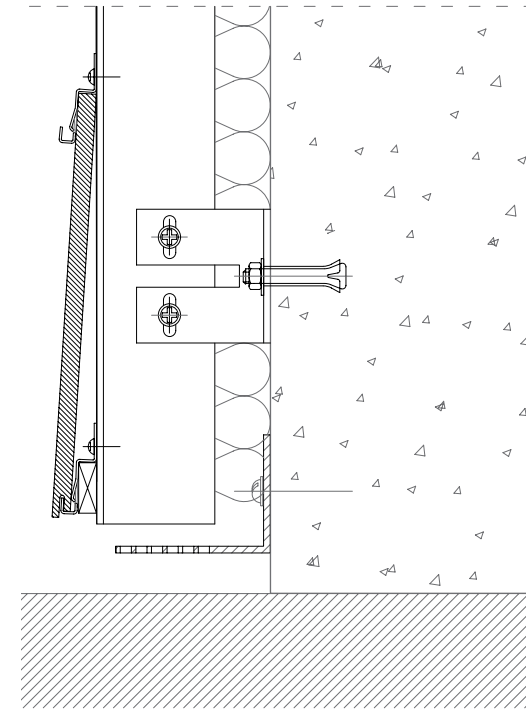

The overlapping slats system enables a range of assembly procedures without needing to change the position of the parts' profiles.

Two different slat widths are supplied: 190 and 290 mm, both with a maximum length of 2440 mm. This concealed fixing system is only valid for thicknesses of 8 mm.

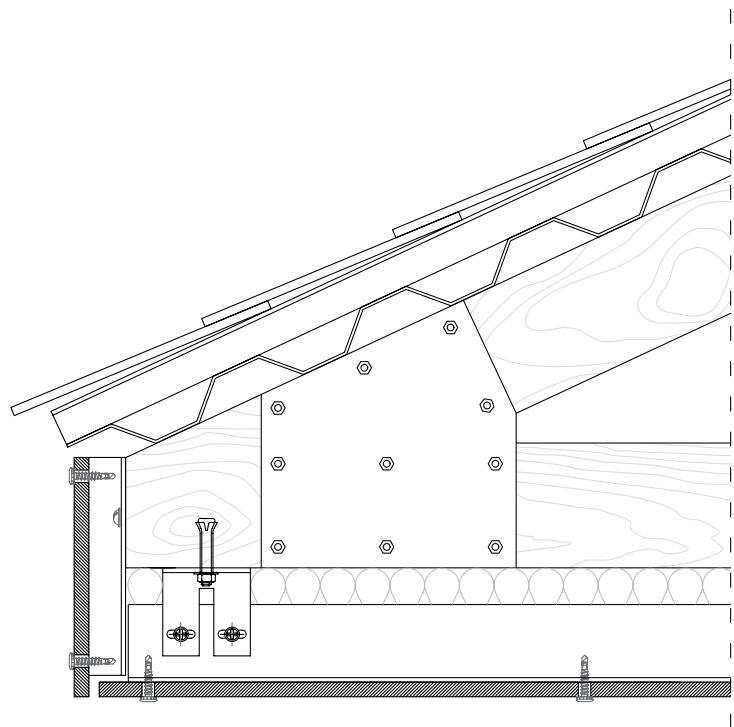

The Facade boards can be installed on false ceilings by means of exposed or concealed fixing systems.

In the case of false ceilings, a minimum perimeter space of 20 mm must be left to enable ventilation through the chamber.





To install Facade, Parklex® offers metal profiles, screws and rivets.

Tests	Standard	Property or attribute	Unit of measurement	Result	
				Parklex® Facade S (Standard) Rev: 09 (02.2013)	Parklex® Facade F (Fireproof) Rev: 10 (04.2013)
1. Inspection					
Colour, pattern and surface finish	EN 438-8 Part 5.2.2.3	Due to the fact that wood is a natural product, each veneer must be considered as unique. It is normal for there to be differences in colour and grain. Singularities such as knots or resin inclusions are not defects, but are part of the decorative design. There are differences in the light fastness performance of the colour, depending on the wood species and source.			
2. Dimensional tolerances					
Thickness (t)	EN 438-2 Part 5	6.0 ≤ t < 8.0 8.0 ≤ t < 12.0 12.0 ≤ t < 16.0 16.0 ≤ t < 20.0 20.0 ≤ t < 25.0	mm	± 0.40 ± 0.50 ± 0.60 ± 0.70 ± 0.80	
Flatness (f)	EN 438-2 Part 9	6.0 ≤ t < 10.0 10.0 ≤ t	mm/m	5 3	
Length and width	EN 438-2 Part 6	-	mm	+10 / -0	
Edge straightness	EN 438-2 Part 7	-	mm/m	1.5	
Squareness	EN 438-2 Part 8	-	mm/m	1.5	
3. Physical properties					
Dimensional stability	EN 438.2 Part 17	Cumulative dimensional change (t ≥ 6mm)	% max. longrain % max. crossgrain	0.3 0.6	
Resistance to impact	EN 438-2 Part 21	Drop height without mark above 10mm (t ≥ 6mm)	mm	≥ 1,800	
Tensile strength	EN ISO 527-2	Longrain Crossgrain	MPa	≥ 60	
Graffiti resistance	ASTM D 6578:2000	Cleanability level	Permanent blue marker Red spray paint Black wax crayon Black marker	4 4 1 2	
4. Weather resistance					
Resistance to UV light	EN 438-2 Part 28 Rating according to EN 20105 - A02	Contrast	Grey scale rating	≥ 3	
		Appearance	Rating	≥ 4	
Resistance to artificial weathering	EN 438-2 Part 29 Rating according to EN 20105 - A02	Contrast	Grey scale rating	≥ 3	
		Appearance	Rating	≥ 4	
5. CE Safety requirements					
Water vapour permeability	EN 438-7 Part 4.4	Wet cup method Dry cup method	μ	110 250	
Resistance to fixings	EN 438-7 Part 4.5	Strength t ≥ 6mm Strength t ≥ 8mm Strength t ≥ 10mm	N	≥ 2,000 ≥ 3,000 ≥ 4,000	
Flexural strength	EN ISO 178	Longrain Crossgrain	MPa	≥ 80 ≥ 80	
Flexural elastic modulus	EN ISO 178	Longrain Crossgrain	MPa	≥ 9,000 ≥ 9,000	
Thermal conductivity/resistance	EN 12664	Thermal conductivity (λ)	W/m K	0.266	0.281
Resistance to climatic shock	EN 438.2 Part 19	Appearance	Rating	≥ 4	
		Flexural strength	Ds rating	≥ 0.95	
		Flexural modulus	Dm rating	≥ 0.95	
Density	EN ISO 1.183	Density	g/cm³	≥ 1.35	
Resistance to damp	EN 438-2 Part 15	Increase in mass	%	≤ 5	≤ 8
		Appearance	Rating	≥ 4	≥ 4
6. CE Safety requirements - Reaction to fire					
Reaction to fire	EN 13.501-1	Euroclass t ≥ 6 mm Euroclass t ≥ 8 mm	Classification	C-s2,d0	B-s1,d0
Providing the panels are stored according to the manner and conditions recommended by the manufacturer.					
Board measurements					
Length (direction of the grain) x width	2440 x 1220 mm	Thickness*	6, 8, 10, 12,14, 18, 20 & 22 mm		

* 6 mm only for special applications. Please ask us if you require other thicknesses.

EDITING & PRODUCTION
PARKLEX INTERNATIONAL S.L.U.

ART DIRECTION
JAUME RAMÍREZ STUDIO

TEXT
CHESCA GUIM

PHOTOGRAPHY
MARÇAL VAQUER
YOSIGO

PRINTED IN BARCELONA
BY AGPOGRAF
SEPTEMBER 2018





For further information:

Sofian Aguelmous — Managing Director
e. sofian@industriarc.com
m. 0411 447 837 t. 02 9571 9541
w. industriarc.com
a. Suite 2.05/55 Miller Street, Pyrmont NSW 2009