

PROFESSIONAL PORTABLE
MIC/LINE PREAMPLIFIER

SONOSAX

SX-AD8+

USER MANUAL

Firmware Revision 1.0
November 2016

Audio equipment manufacturer

SONOSAX SAS S.A.
Ch. de la Naz 38
CH-1052 Le Mont-sur-Lausanne
Switzerland
<http://www.sonosax.ch>
sonosax@sonosax.ch

Table of Contents

1	Introduction.....	3
1.1	Features.....	3
2	Panel Descriptions.....	4
2.1	Front Panel.....	4
2.2	Left Side Panel.....	5
2.3	Right Side Panel.....	5
3	Functional Description.....	6
3.1	Input Audio Path.....	6
4	Standalone Operation.....	7
4.1	Powering the SX-AD8+.....	7
4.2	Input Configuration.....	7
5	Web Interface Operation.....	8
5.1	Enabling Web Interface.....	8
5.2	Top Menu.....	9
5.3	Input Slice.....	10
5.4	Setup Button.....	10
5.5	Input Setup.....	11
6	SX-R4+ Remote Operation.....	12
6.1	Enabling SX-R4+ Remote Operation.....	12
7	Service Mode.....	13
7.1	Introduction.....	13
7.2	Entering Service Mode.....	13
7.3	Service Mode Web Interface.....	13
7.4	Firmware Update.....	15
8	Performance Plots.....	16
8.1	Frequency Response Plot.....	16
8.2	LF Cut filter Plot.....	16
8.3	FFT Plots.....	17
9	Specifications.....	18
9.1	Analog Inputs.....	18
9.2	Low Frequency Cut Filter.....	18
9.3	Digital Domain.....	18
9.4	Power.....	18
9.5	Mechanical.....	18
10	Connector Pin Assignments.....	19
10.1	XLR.....	19
10.2	Hirose 4.....	19
10.3	3M MDR 26-pin.....	19

1 Introduction

Congratulation for purchasing your SONOSAX SX-AD8+ professional portable microphone / line preamplifier. Based on high technology design, it has been manufactured to deliver many years of outstanding performances.



As with all SONOSAX products, the SX-AD8+ is build without any compromise in quality, using only the best components available and passes severe quality controls.

The information and instructions contained in this manual are necessary to ensure safe operation of your equipment and to maintain it in good operating condition; please read it carefully.

1.1 Features

Inputs / Outputs

- 8 Mic/Line inputs, electronically balanced on XLR-3, phase reversal, 48V phantom, LF Cut and level control on front panel
- 4x AES3 transformer balanced outputs on 3M MDR 26-pin connector

Performance

- 135 dB (A-weighted) overall dynamic range
- 90 kHz overall frequency response @192k
- 40-bit processing
- 24-bit 48/96/192 kHz

User Interface

- Basic configuration using knob push-buttons
- Configuration through WiFi dynamic web interface
- Remote configuration through SONOSAX SX-R4+ touch screen

2 Panel Descriptions

2.1 Front Panel

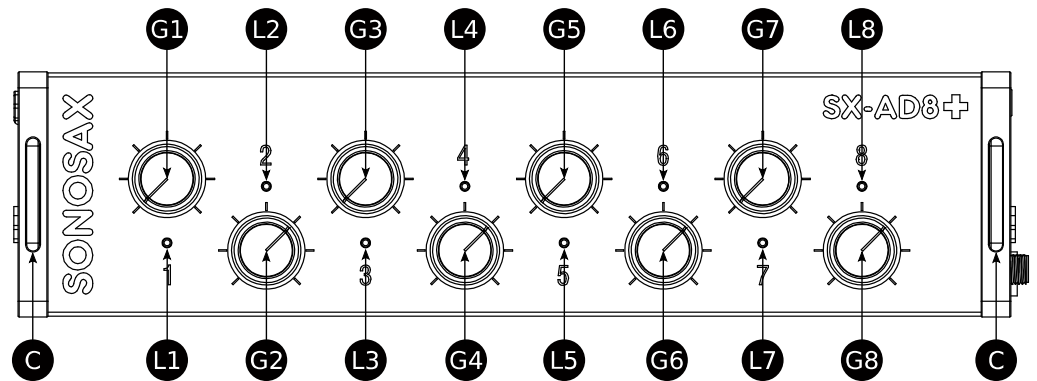

G1 to G8
Audio Input Gain with push on

C
Cut-out for shoulder strap

L1 to L8
Tri-color LEDs:

OFF	input is powered off
Light Green	no signal detected
Green	signal activity
Orange	input signal reached orange level
Red	input signal reached red level or input level too high

2.2 Left Side Panel

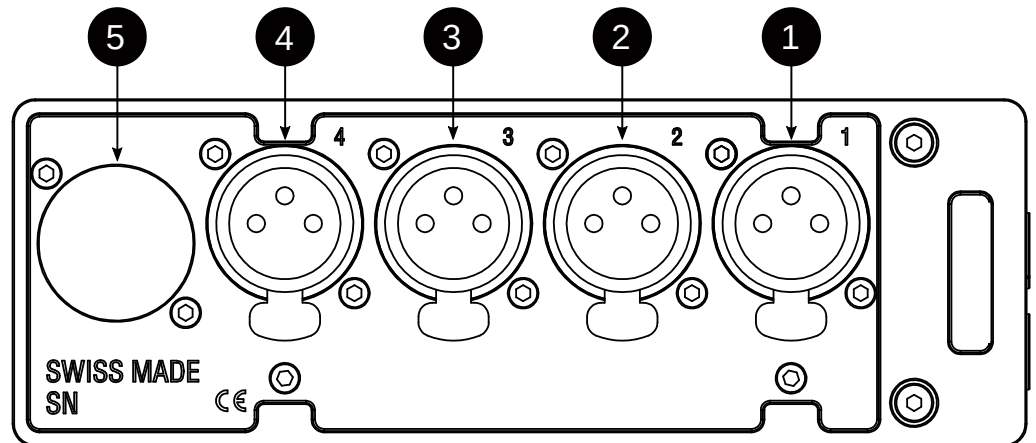

1 to 4 [XLR]
Analog electronically balanced Mic/Line
Inputs 1 to 4

5
Option Card Slot

2.3 Right Side Panel

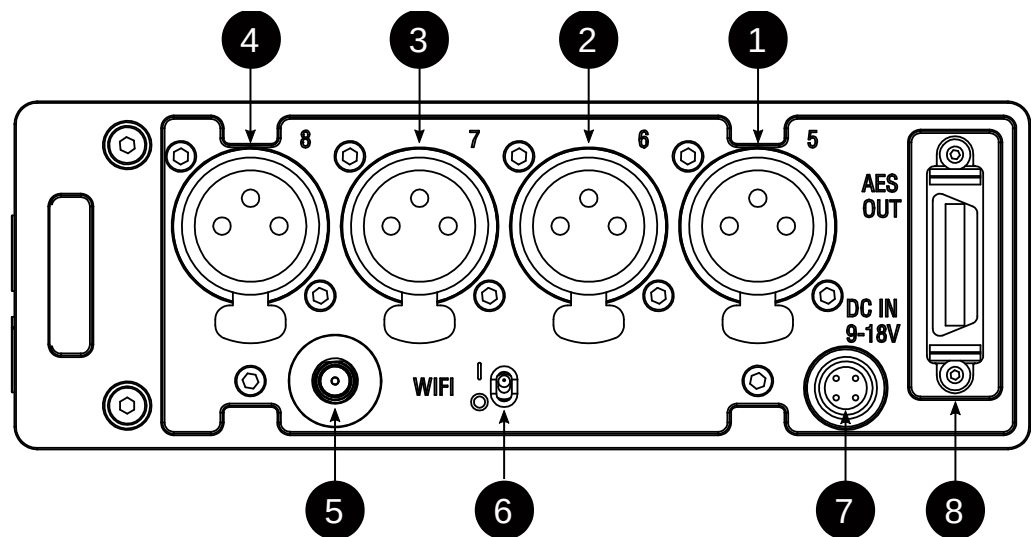

1 to 4 [XLR]
Analog electronically balanced Mic/Line
Inputs 5 to 8

5 [SMA Female]
WiFi antenna connector

6 WiFi enable switch

7 [Hirose 4]
External power supply, 9 to 18V DC

8 [3M MDR 26-pin]
4x AES outputs
SX-R4+ interface link

3 Functional Description

3.1 Input Audio Path

The SX-AD8+ audio hardware consists of 8 identical inputs. Each input is converted to digital and encoded to an AES stream.

The following figure describes an input audio path:

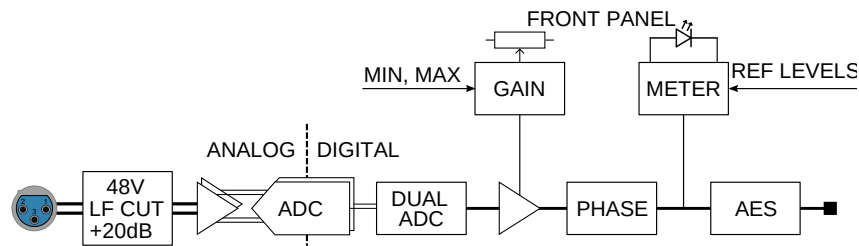

Analog Domain

- 48V phantom power
- +20dB switchable analog gain
- Low Frequency Cut (LF CUT)

Analog to Digital conversion

A very high dynamic range is achieved by using two Analog to Digital Converters (ADC) per channel, driven by a software algorithm.

Digital Domain

- Input gain is computed using front panel input gain knob position, user defined MIN/MAX values of that knob and gain linking configuration.
- Signal polarity (normal, reversal)
- Signal level metering lit front panel LED
- Output is AES encoded

4 Standalone Operation

4.1 Powering the SX-AD8+

The SX-AD8+ operates as soon as the input DC voltage is applied, there is no power switch button.

Once powered, the SX-AD8+ operates immediately as it was on last power down.

To operate in standalone mode, the WIFI should be switched OFF to save power.



4.2 Input Configuration

In standalone mode, device configuration is done using input gain push-buttons and LEDs.

To configure an input, apply a long press to the selected input gain knob until selected input LED blinks (in red).

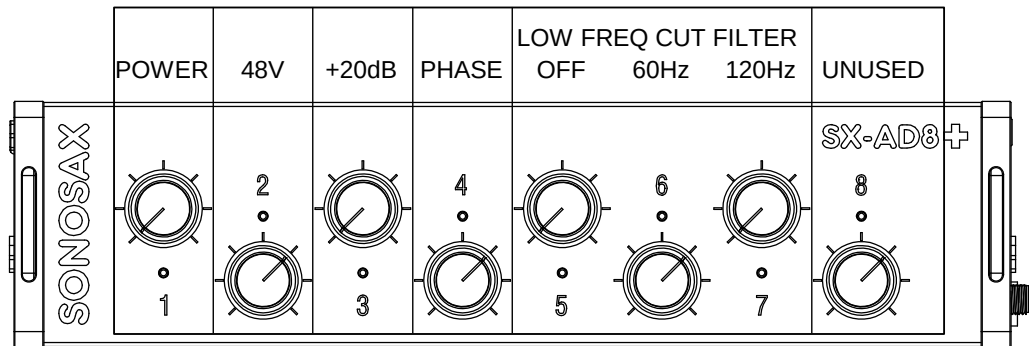

When input configuration is enabled, knobs and LEDs 1 to 7 are used to change input setup:

1 – INPUT POWER

LED off: input OFF
LED green: input powered

2 – PHANTOM POWER 48V

LED off: no phantom power
LED green: 48V phantom power

3 – INPUT GAIN +20 dB

LED off: input gain 0 dB
LED green: input gain +20 dB

4 – PHASE REVERSAL

LED off: input phase normal
LED green: input phase reversed

5, 6, 7 – LOW FREQUENCY CUT FILTER (LF CUT)

LED 5 green: LF CUT disabled
LED 6 green: LF CUT 60 Hz
LED 7 green: LF CUT 120 Hz
LEDs 5-7 are mutually exclusive

To exit input setup, apply a long press to any input gain knob.

5 Web Interface Operation

5.1 Enabling Web Interface

The Web interface allows users to fully controls the SX-AD8+ using a computer, a tablet or a smartphone. The following steps are required to enable that interface:

1. Enable the wireless access point by setting the WIFI switch to '1' on the Right Side Panel:



2. Connect to the SX-AD8+ WIFI network. Network name (SSID) is SX-AD8+_SNxxxxx, where xxxxx is the device serial number. No password is required.
3. Launch a web browser and use 192.168.1.1 as the URL (instead of http://). Firefox and Chrome are fully tested, it should also work with other browsers like Safari, Microsoft Edge or Opera.

The web interface is shown as below:

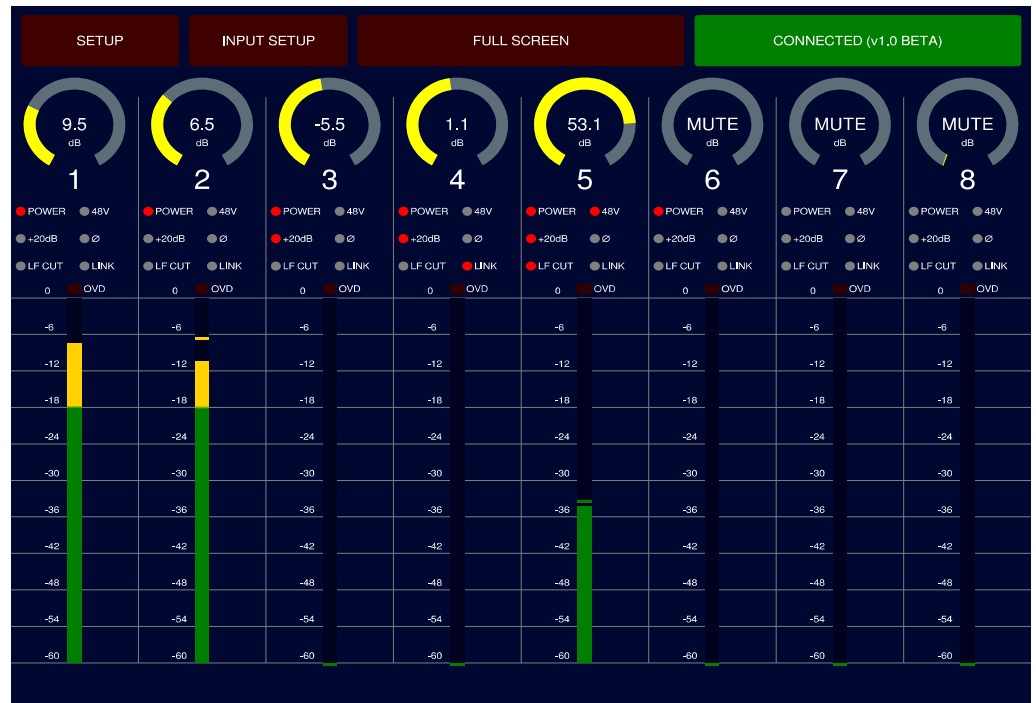

The main page consists of a top menu and 8 identical input slices.



NOTE

Only one host can connect to the web interface at a time.

5.2 Top Menu



From left to right:

SETUP

Calls a general setup menu

INPUT SETUP

Call an input setup menu

FULL SCREEN

Toggles full screen mode

CONNECTION STATUS

Should be green (connected).

Goes orange if the connection break or in case of hardware failure.

In case of connection problem, toggles connection open/close.

5.3 Input Slice

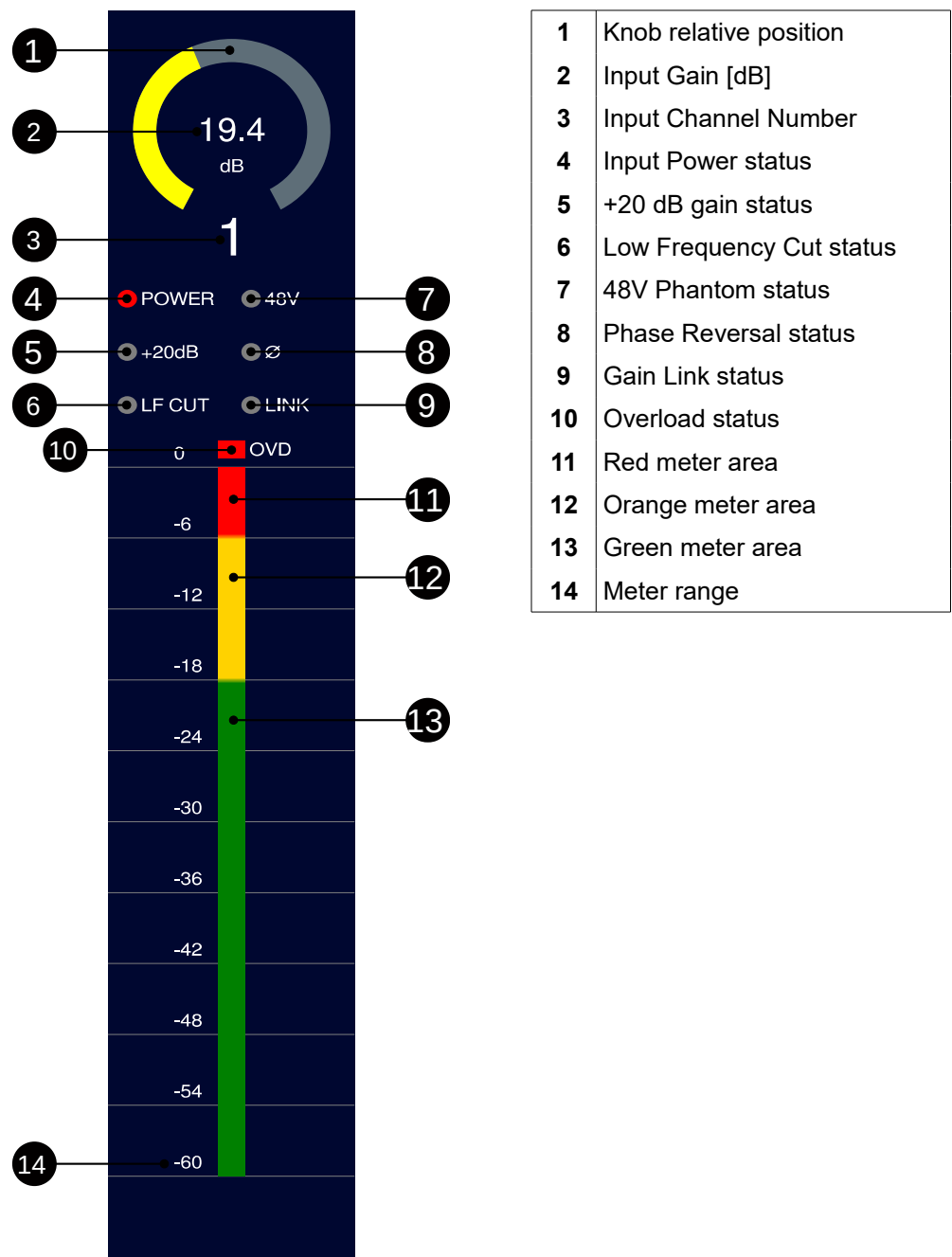

5.4 Setup Button



The SETUP button only modifies the top bar menu. When active, the following parameters are available:

- Sampling Frequency: select between 48, 96 or 192 kHz.
- WLAN channel: select the WLAN channel to be used for WIFI interface. After modification, a WIFI network power cycle must be applied.

- LED intensity: set the front panel LED intensity. Note that 0% fully disables LEDs.

5.5 Input Setup

The Input Setup button calls the input setup page:



The top menu consists of three parameters:

- ORANGE LEVEL: defines the level where signal should be seen as orange
- RED LEVEL: defines the level where signal should be seen as red
- METER RANGE: defines the overall meter range



NOTE

Orange, red and meter range apply to web interface meters **and** front panel LEDs.

The input area consists of the following parameters:

- MIN: minimum gain value [dB]. This is the lower gain value just after unmuting input with the gain knob.
- MAX: maximum gain value [dB]. This is the higher gain value when gain knob is at maximum
- POWER: toggles input power
- 48V: toggles 48V phantom power
- +20: toggles +20 dB gain
- Ø: toggles phase reversal
- LF CUT: OFF, 60Hz, 120Hz
- LINK: gain is linked when LINK is set to a target channel number

6 SX-R4+ Remote Operation

6.1 Enabling SX-R4+ Remote Operation

To connect with a SX-R4+, WIFI enable switch must be disabled.



Connect the SX-AD8+ to the SONOSAX SX-R4+ multi-tracks recorder with a 3M multi-pin cable and an Hirose power cable.

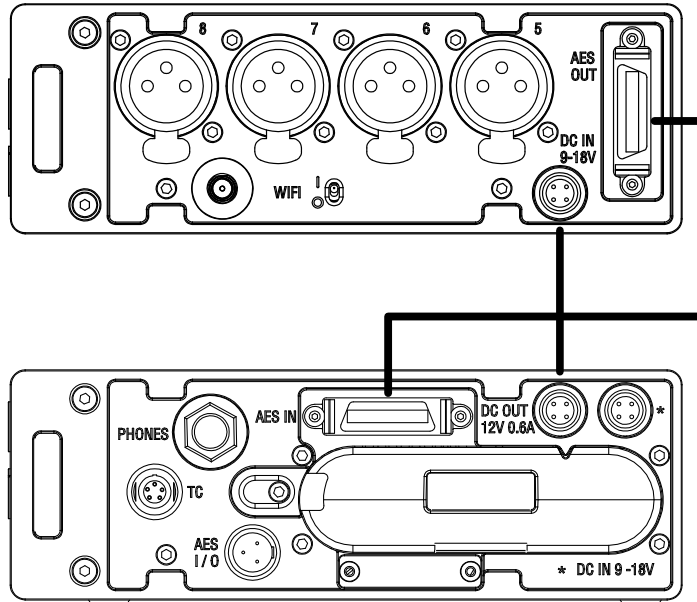

Don't forget to enable DC output in the SX-R4+ POWER menu. As soon as both devices are powered, the SX-AD8+ will connect with the SX-R4+. When operating in this mode:

- The SX-AD8+ configuration is available through the SX-R4+ touch screen
- The SX-AD8+ potentiometers can operate as input gain or faders
- All SX-AD8+ push-buttons can be assigned to a dedicated function

7 Service Mode

7.1 Introduction

The service mode is a separate operation mode for service purpose. It is used for firmware update and to check hardware status.

7.2 Entering Service Mode

Push and keep pressed the knob 8 while applying power to the SX-AD8+. A LEDs animation confirm the service mode: all LEDs become green, then red, then green (or red).

The last LED color indicates the hardware check status. A red color indicates a failure:

LED	Error cause
1	Main board failure (SPI bus)
2	Knobs 1-4 board failure
3	Knobs 5-8 board failure
4	Missing firmware in flash memory
5	XLR 1-4 input board failure
6	XLR 5-8 input board failure
7	Main board failure (I2C bus)
8	Failure detected on the optional card slot

After power-up, the knobs and LEDs operation can be checked by pressing the knobs: each push change the LED color: OFF → light green → green → orange → red.

7.3 Service Mode Web Interface

The service mode exports a dedicated web application. To view it, proceed as following:

1. Enable the wireless access point by setting the WIFI switch to '1' on the Right Side Panel:



2. Connect to the SX-AD8+ WIFI network. Network name (SSID) is SX-AD8+_SNxxxxx, where xxxxx is the device serial number. No password is required.
3. Launch a web browser and use 192.168.1.1 as the URL (instead of http://).

The web interface is shown as below:



The web interface auto-connects to the SX-AD8+. The connection status is given by the connect button on top right of the screen:

Status	Color	Description
CONNECTED	Green	Connected
CONNECTING...	Yellow	Trying to connect
CONNECTED – FAILURE CODE x	Yellow	Connected, but hardware status failure detected
CONNECTED – CONNECTION BREAK	Green or Yellow	Connection breaks. Indicates that the WIFI connection is not ideal (short breaks) or that the connection is not available any more
OFFLINE	Gray	User manually disabled connection

When connected, the System Info section gives an overview of the hardware and software status:

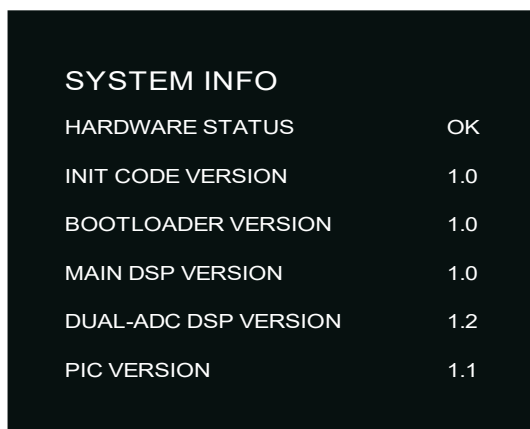

The hardware status should always indicate “OK”. When not, it gives a hardware failure code. The failure code format is a decimal unsigned 32-bit integer, where each bit defines an error cause:

Bit	Error cause
0	Main board failure (SPI bus)
1	Knobs 1-4 board failure
2	Knobs 5-8 board failure
3	Missing firmware in flash memory
4	XLR 1-4 input board failure
5	XLR 5-8 input board failure
6	Main board failure (I2C bus)
22	Option board 4 channels output, I/O expander failure
23	Option board 4 channels output, digital transmitter failure
24	Option board 4 channels output, digital to analog converter failure

The other fields are software revision; value “UNKNOWN” is not an error, it just indicates that the software revision is not available.

The POTs POSITION gauges reflects the raw position of each potentiometer.

7.4 Firmware Update

To apply a firmware update, first download the update file on [Sonosax website](#). Once completed, enter service mode, press the “SELECT FIRMWARE FILE” button and select the update file.

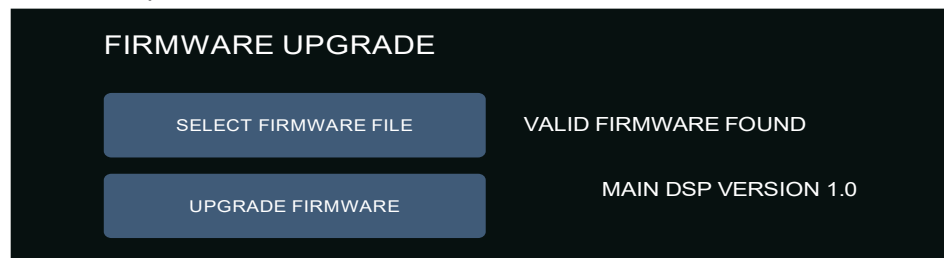

If the update file is valid, an “UPGRADE FIRMWARE” button will appear. Firmware update will begin when pressing that button.

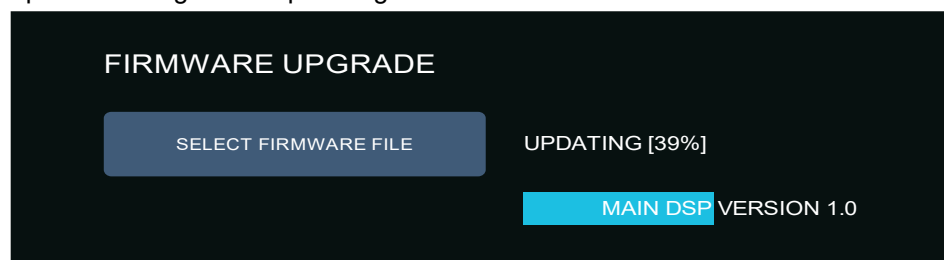

The firmware update is power fail safe: if the process fails, try again. When the update successfully completes, a power cycle is required.

8 Performance Plots

8.1 Frequency Response Plot

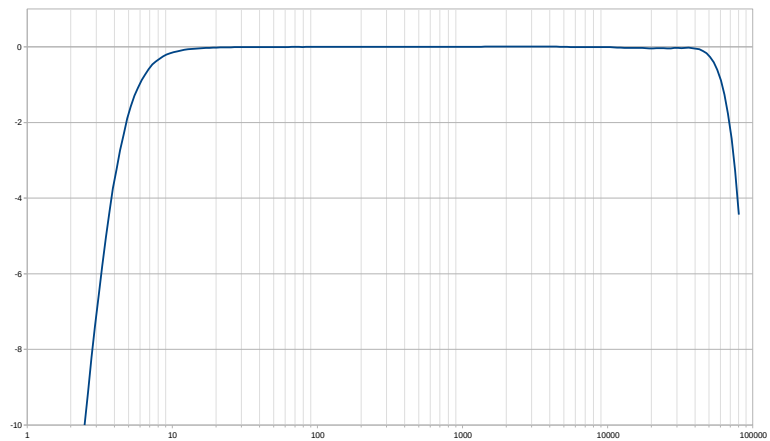

8.2 LF Cut filter Plot

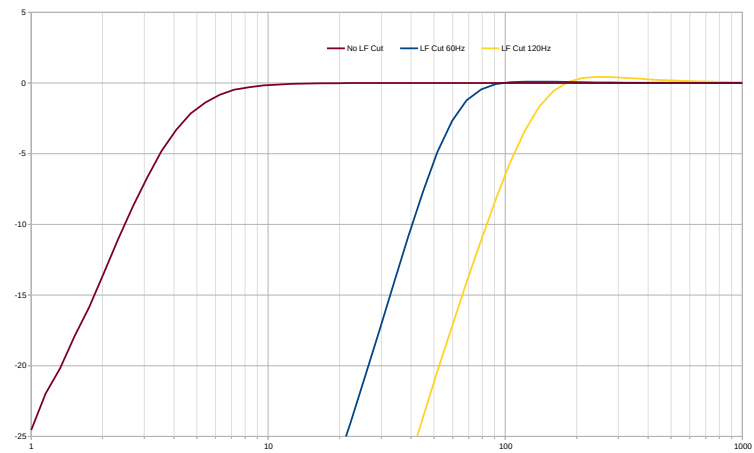

8.3 FFT Plots

Measurements for all performance plots are taken using the following conditions:

- 1 kHz sine wave tone input
- 96 kHz sampling frequency
- Audio Precision Equiripple window

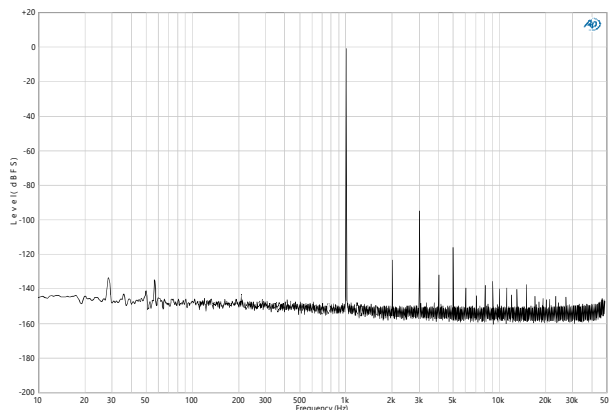

Input: +20 dBu

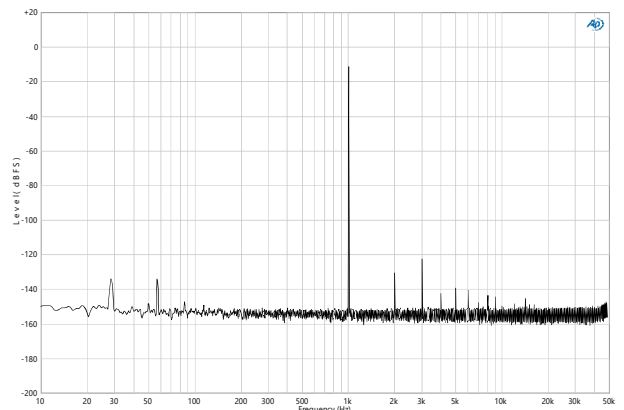

Input: +10 dBu

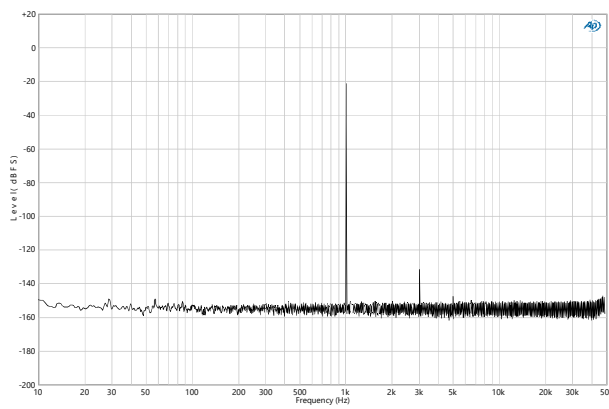

Input: 0 dBu

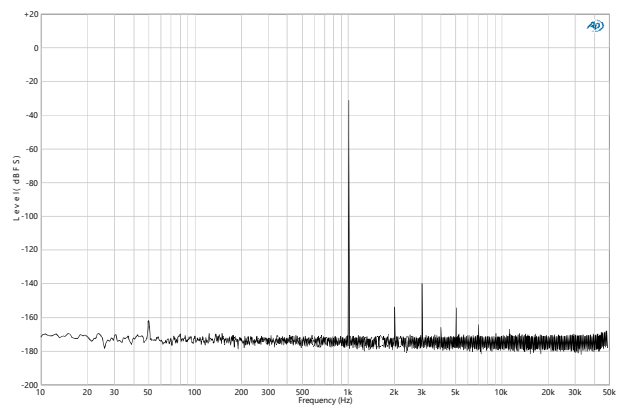

Input: -10 dBu

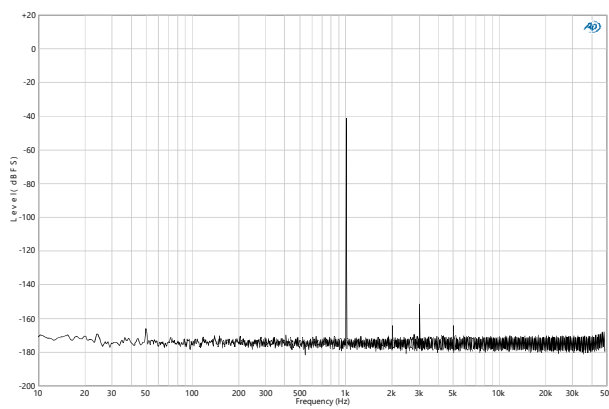

Input: -20 dBu

9 Specifications

9.1 Analog Inputs

Frequency Response	2 Hz to 75kHz (-3 dB) 22 Hz to 22 kHz (+/- 0.1 dB) 192 kHz sample rate
THD + Noise	0.0011% max (1 kHz, 22Hz-22kHz, +10dBu input)
Equivalent Input Noise	-112.5 dBu max (Gain 0dB, 22Hz-22kHz, 150 Ohms) -126 dBu max (Gain +20dB, 22Hz-22kHz, 150 Ohms)
Maximum Input Level	+21 dBu (Gain 0dB) 1 dBu (Gain +20dB)

9.2 Low Frequency Cut Filter

Frequency Response	Third order, 60 or 120 Hz See LF Cut filter Plot
--------------------	---

9.3 Digital Domain

Sampling Frequency	48 kHz, 96 kHz, 192 kHz
A/D	2x 24-bit per channel 40-bit processing
A/D Dynamic Range	135.5 dB, A-weighted (Gain 0dB) 129.5 dB, A-weighted (Gain +20dB)
Output Bit Depth	24-bit
Outputs	4x AES3 transformer balanced outputs on 3M MDR 26-pin

9.4 Power

Input Voltage	9-18V DC on locking Hirose 4
Power consumption, all input enabled	6.0 W

9.5 Mechanical

Size (H x W x D)	200 x 50 x 144.5 mm 7.87 x 1.96 x 5.7 "
Weight	850 g 1.9 lbs

10 Connector Pin Assignments

10.1 XLR

	<ul style="list-style-type: none"> 1 ground 2 signal (+) 3 Signal (-)
---	--

10.2 Hirose 4

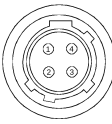
	<ul style="list-style-type: none"> 1 ground (-) 2 not connected 3 not connected 4 DC input (+)
---	--

10.3 3M MDR 26-pin

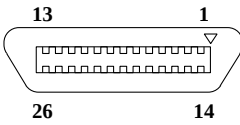
	<ul style="list-style-type: none"> 1 ground 2 AES 1-2 (-) 3 AES 3-4 (-) 4 AES 5-6 (-) 5 AES 7-8 (-) 6 – 8 not connected 9 RS422 RX (-) 10 RS422 TX (-) 11, 12 not connected 13, 14 ground 15 AES 1-2 (+) 16 AES 3-4 (+) 17 AES 5-6 (+) 18 AES 7-8 (+) 19 – 21 not connected 22 RS422 RX (+) 23 RS422 TX (+) 24, 25 not connected 26 ground
---	---