

AluK C70S Window System

Introducing the new **ALUK C70S** Window System

Beautifully engineered and brilliantly functional, the C70S delivers class-leading performance with U-values of 1.3 W/m²K, advanced water tightness and a range of features to simplify fabrication and installation.

Meeting and exceeding the key thermal, acoustic and performance demands of architects and specifiers, the C70S is the perfect, aluminium solution for both the residential and commercial markets.

Raising the Standard

- **Market-Leading Thermal Performance**
1.3 U-values with 1.0 W/m²K Ug Glass, and 1.1 U-values with a 0.7 W/m²K Ug glass for increased thermal performance
- **Class-leading Wind and Water Tightness**
Lowest possible level of air leakage and exceptional resilience to water ingress
- **50mm Acoustic Glazing Option**
Acoustic glazing can be installed to address city-centre projects with the cost-effective C70S window
- **Faster, Simpler Fabrication and Installation**
Innovative design features such as 'snap-in' PVC profile to fit the EPDM carrier, and the option of crimped or mechanical cleats





Specifier focus

Engineered to the highest UK standards, the C70s window system will enhance any type of project; from heritage and refurbishments, through to ultra-modern applications, with a range of textured and anodised finishes available to suit your design.

With impressively narrow profiles, the new system is both inward and outward opening, in Top Hung, Side Hung, Tilt before Turn, and Fixed Light.

Advanced performance, competitive price

- › **Impressive thermal performance**
U-values as low as 1.3 double and 1.1 triple glazing. Add more insulation to improve U-values with a choice of Standard, Partial and HI insulation options
- › **Up to 50mm glazing capacity**
For urban noise reduction and thermal performance
- › **Maintain sightlines**
With reversible rebates – glaze internally or externally with adaptors – ideal for high rise projects
- › **Sub cill profile for press metal**
3mm-thick pressed cills can be added after window installation, to avoid damage during building construction. Easy-access fixings concealed by painted-matched aluminium cover strip
- › **Exceptional Water and Air Tightness**
With test results of 1500Pa, the C70s has achieved the highest possible level of water tightness, far exceeding the standard market requirement of 600Pa
- › **Colourful range** – Available in a wide range of single, dual, textured and anodised colour finishes
- › **Safe and certified**
Certified under the Secured by Design scheme, PAS 24 on inward and outward opening windows, and Doc Q compliant

Key ancillaries available:

- › **Curtain wall insert adapters for open-in and open-out**
- › **Concealed coupler**
- › **Couplers for door products**
- › **Expansion coupler**
- › **Reinforcing add-on for high wind loads**



Suited handle range

C70s suited casement and TBT handles are available in black, white, grey, satin silver.



Fabricator focus

The C70S is a cost-effective yet high-performance window with a host of features for flexible, faster fabrication and installation. Exceptional wind and water tightness, yet slim sightlines make this a smart choice for any project.

With sightlines consistent with the enduring 58BW system, you have greater flexibility to mix and match the C70s to address a broad range of requirements with a uniform aesthetic.

Faster, simpler fabrication

› Simple assembly

Clip-together assembly of sub cill, frame extenders, Z adapter, and EPDM carrier closer profile

› Shared Parts with 58BW System

The C70s design utilises shared parts with the 58BW system to improve stockholding

› Choice of corner cleats

Mechanical or crimped – work with your preferred choice and build faster

› Z adapter profile

Allows reversed glazing without the need for a frame reverser, ideal for glazing at height

› Stock offer

Available in stock on a 5-day lead time in the following colours: 9910HG (white), 7016M (grey), 9005M (black), and dual-colour white/grey and white/black options

EPDM Innovation

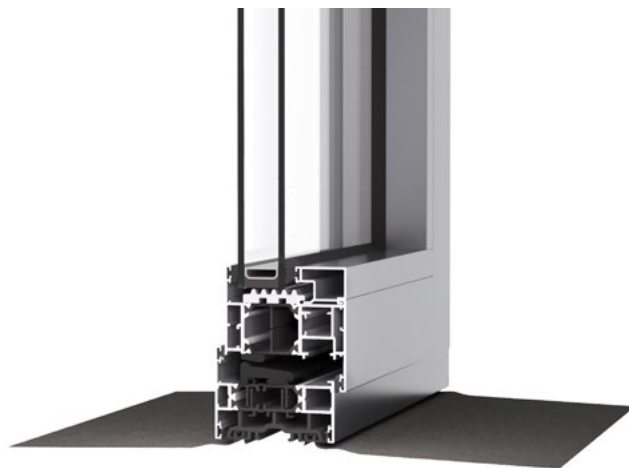

Universal EPDM carrier groove – allows clip-in EPDM strip and direct lug fixing to be used on all outer frames, frame extenders and sub cill profiles. The EPDM can be fitted reliably and easily with a 'snap-in' PVC profile, supplied by AluK.

Key features

› Open-in Details

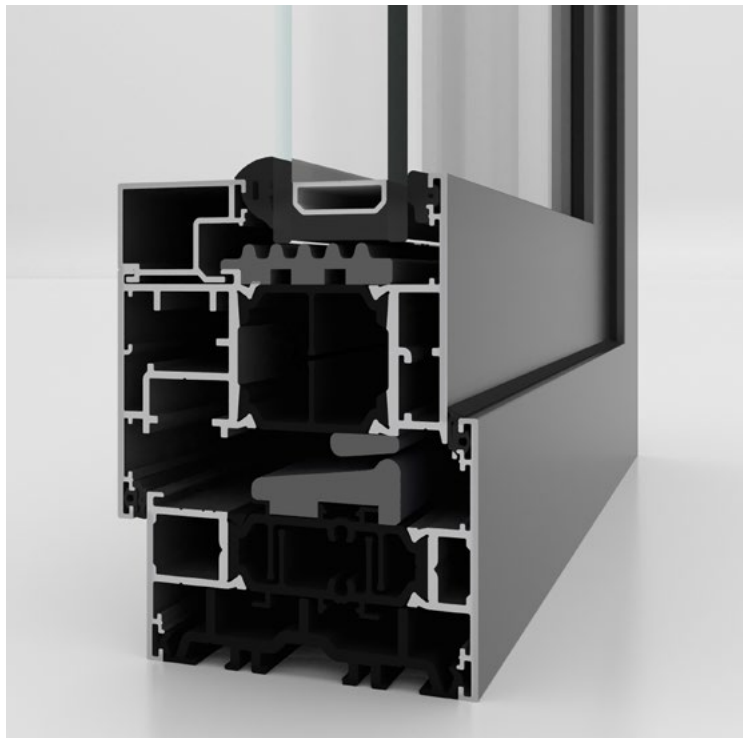

› Open-out Details

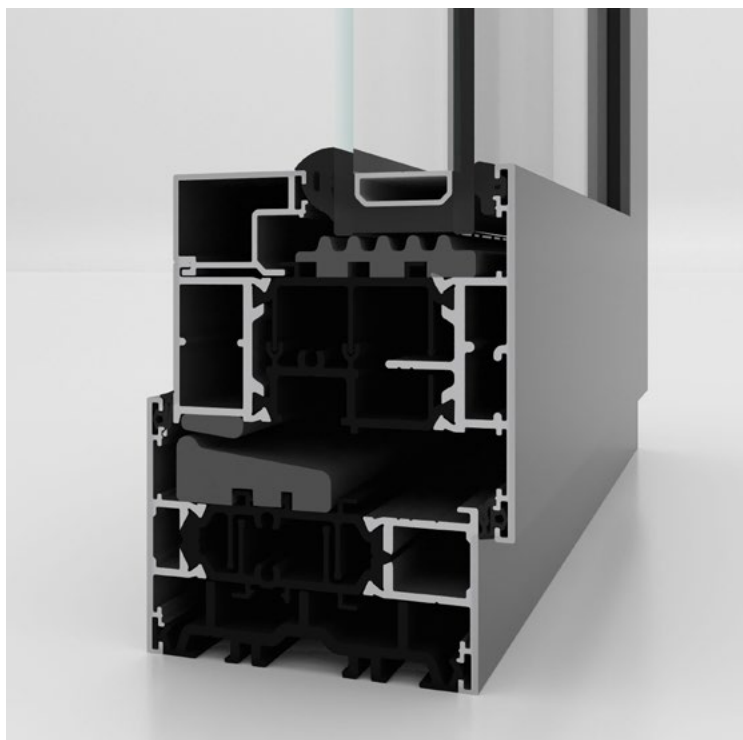

Fabrication

The C70S window system can be fabricated using either a mechanical, or crimped process. An EPDM carrier has been designed to be fitted easily with a 'snap-in' PVC profile.

Sizes

The C70S window system is available in the following options:

	Hinge Type	Glazing Max. Weight (kg)	Min Size (mm)	Max Size (mm)
Top Hung	Standard	50*	320w x 200h	1680w x 1500h
	Medium	50*	320w x 850h	1680w x 1500h
	Heavy Duty	180*	320w x 267h	1680w x 2500h**
Side Hung	Standard	24*	306w x 320h	700w x 1680h
	Medium	40*	409w x 320h	1000w x 1680h
	Heavy Duty	55*	300w x 320h	838w x 1680h
Tilt & Turn	-	130*	480w x 375h	1300w x 2300h
Fixed Light	-	300*	300w x 300h	2300w x 2300h

* Maximum sash load will be dependent upon the glass unit makeup and size of the window configuration.

** Please contact Aluk's Technical department.

NB Max/min sizes measured from the extremities of each profile used: fixed lights taken from edge of outer frame, side/top hung, TBT taken from edge of open vent, not including outer frame.

Performance and security

The C70S window system has been independently security tested to PAS 24:2016 and weather tested to BS 6375 1-3:2015.

	C70S Open-In	C70S Open-Out
Air Infiltration BS EN 12207:2000	Class 4 (600pa)	Class 4 (600pa)
Water Tightness BS EN 12208:2000	E900 (900Pa)	E1500 (1500Pa)
Wind Resistance BS EN 12210:2000	CE 2400 (2400Pa)	E 2400 (2400Pa)

Thermal Performance

With an ever-increasing demand from building regulations, the C70S window system is designed to meet the high-performance requirements of today's building specifications. With three levels of insulation, the C70S gives you flexibility to design U-values to suit your project and budget.

There are three levels of insulation to choose from:

- › **C70S Standard** – with no additional foams
- › **C70S Partial** – which offers partial added insulation
- › **C70S HI** with extra insulation for lower U values

The C70S Partial and C70S HI are fabricated using hidden foam strips. The C70S HI has additional foam strips with a black TPE surface finish for durability and ease of cleaning. These foam strips are retained by a high-performance, long-lasting adhesive backing.

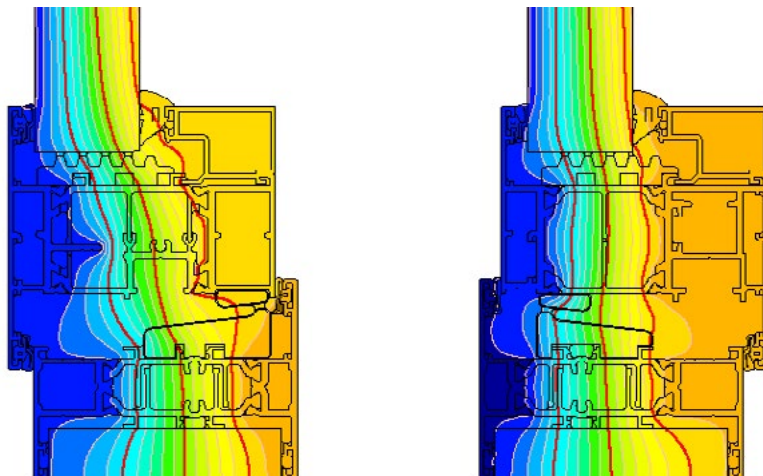

	Open-out		Open-in / TBT	
	Double Glaze 1.0 Ug	Triple Glaze 0.7 Ug	Double Glaze 1.0Ug	Triple Glaze 0.7 Ug
C70S	1.6	1.4	1.5	1.3
C70S Partial	1.5	1.2	1.4	1.2
C70S HI	1.3	1.1	1.3	1.1

Based on a CEN commercial window 1,260mm x 1,480mm

C70S Specifications

	C70S HI Open-in	C70S HI Open-out
Performance and accreditations		
Uw (Double Glazing)	1.3W/m ² k	1.3W/m ² k
Uw (Triple Glazing)	1.1W/m ² k	1.1W/m ² k
Window Energy Rating	A Rated	A Rated
Air Tightness (Pa)	Class 4 (600Pa)	Class 4 (600Pa)
Water Tightness (Pa)	E900 (900Pa)	E1500 (1500Pa)
Wind Load (Pa)	Class E2400 (2400Pa)	Class E2400 (2400Pa)
Security	PAS 24 & SBD	PAS 24 & SBD
Configurations		
Top Hung	-	✓
Side Hung	✓	✓
Bottom Hung	✓	✓
Tilt before Turn	✓	-
Fixed Light - internally glazed (Reversers available)	✓	✓
Fixed Light - externally glazed (Reversers available)	✓	✓
Glazing		
Glazing panel options: double and triple	24mm - 50mm	24mm - 50mm
Design features		
Variable Handle Position	✓	✓
Trickle ventilation	✓	✓
Sightlines	89mm	89mm
System depth		
mm	70mm	70mm
Sightlines		
Frame to Vent	89mm	89mm
Vent to Mullion	103mm	103mm
Fixed Light	43mm	43mm
Hardware		
Locking Handles	✓	✓
Friction Hinges	-	✓
Butt Hinges	-	✓
Groove type	PVC Euro 16mm	PVC Euro 16mm
Finishes		
Single Colour	✓	✓
Dual Colour	✓	✓
Anodised	✓	✓
Textured	✓	✓

Technical Open-in

› **Frame and vent details**

Internally glazed fixed light on a 43mm outer frame

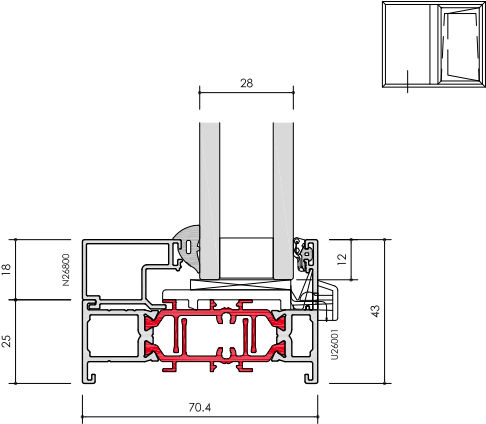

› **Deep head detail**

Deep head, trickle vent hardware, externally glazed, fixed light

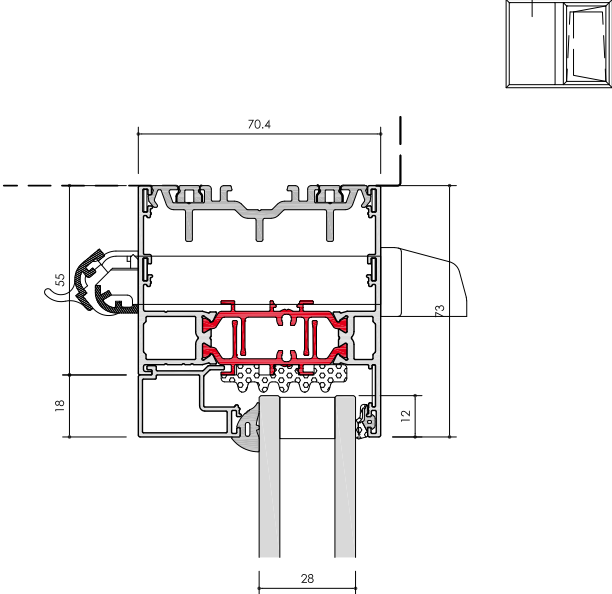

› **Transom and Mullion details**

Internally glazed fixed light, slim mullion

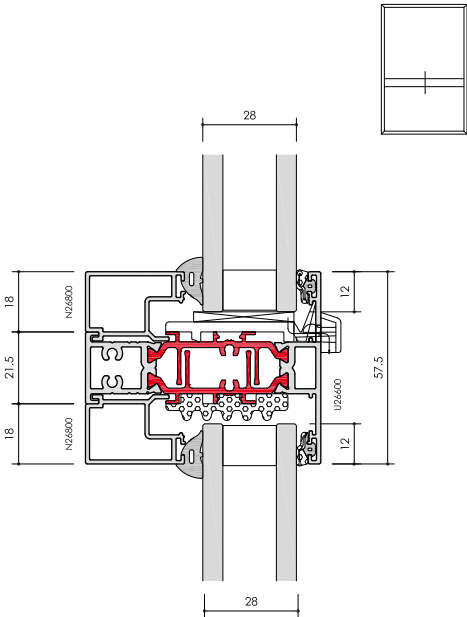

› **Transom and vent details**

Internally glazed Open-in vent, transom over internally glazed fixed light

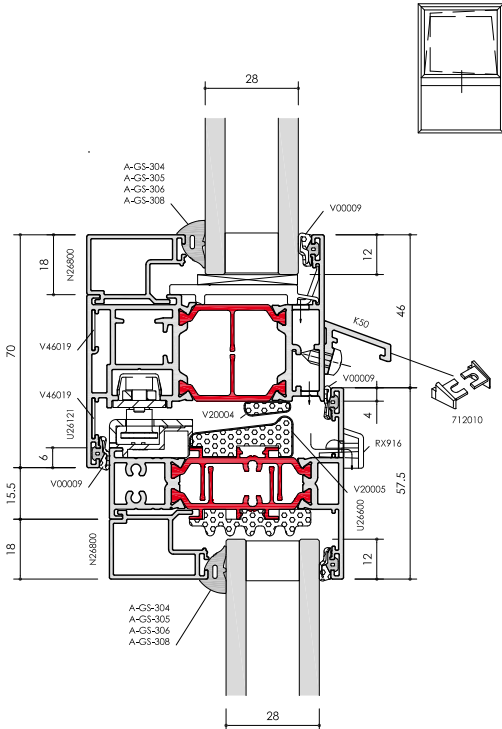

› **Frame reverser detail**

Fixed light externally glazed, frame reverser over 53mm outer frame

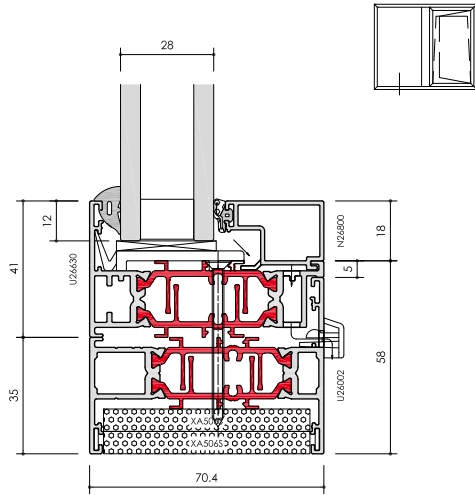

› **Curtain wall adapter detail**

Internally glazed Open-in vent over Curtain wall insert, SL50 curtain wall

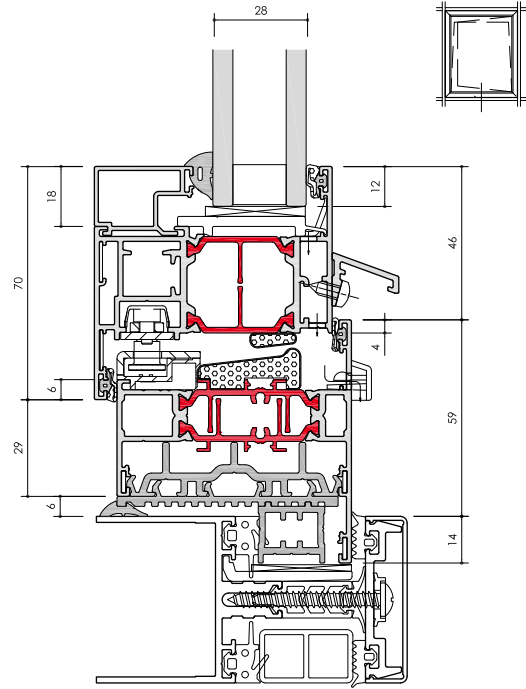

› **Z-Adapter Detail**

Internally glazed fixed light, 53mm outer frame, z-profile, externally glazed fixed light

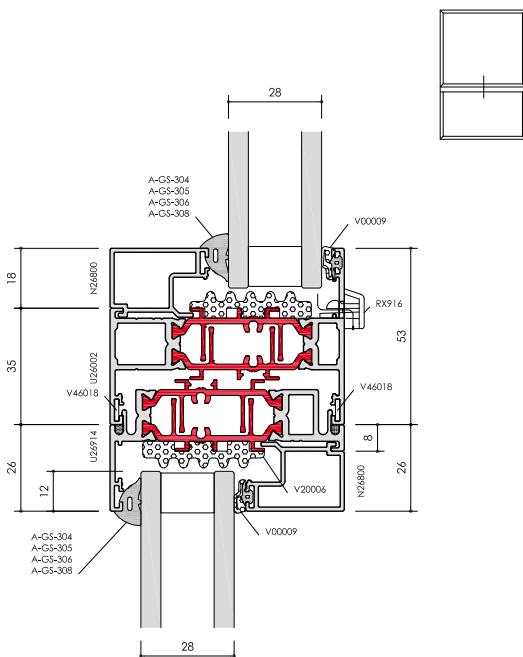

› **50mm Glazing detail**

Internally glazed Open-in vent over 53mm outer frame (50mm Glazing)

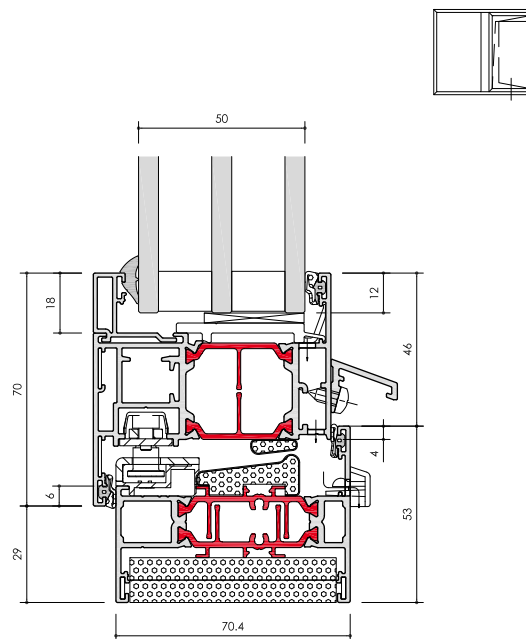

Technical Open-out

› Odd leg Frame detail

Odd leg outer frame over Internally glazed Open out vent

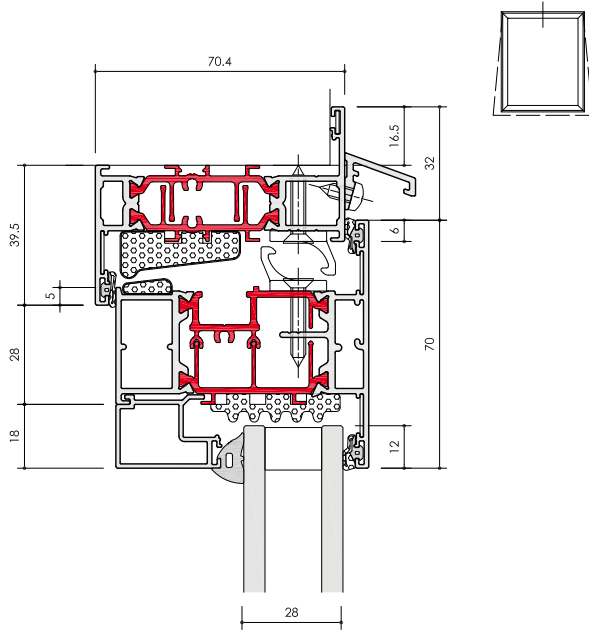

› Deep head detail

Deep head, trickle vent hardware, externally glazed, fixed light

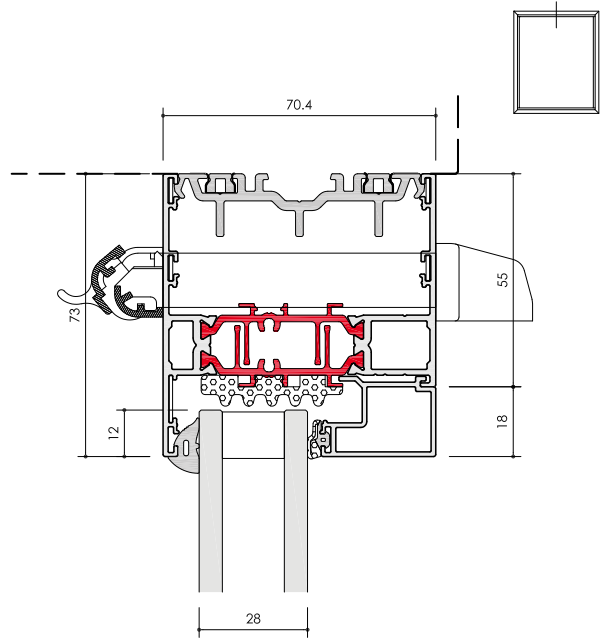

› Mullion details

External glazed fixed light, slim mullion

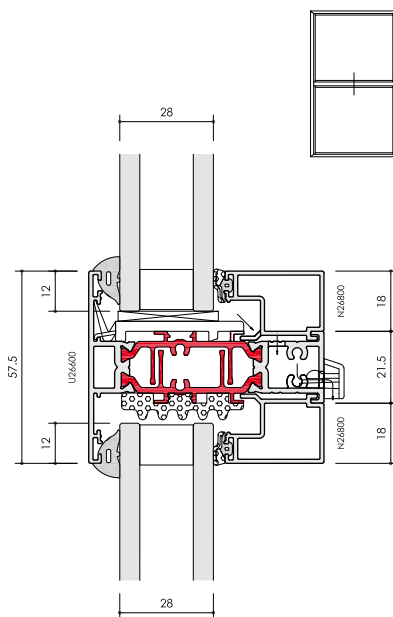

› Transom details

Internally glazed Open-out vent, slim transom, externally glazed fixed light

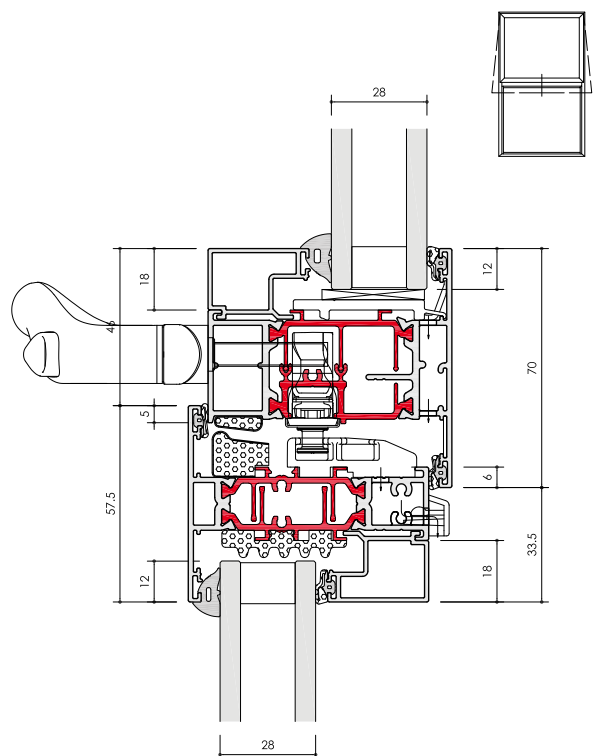

› **Frame reverser detail**

internally glazed Fixed light, frame reverser, 53mm outer frame

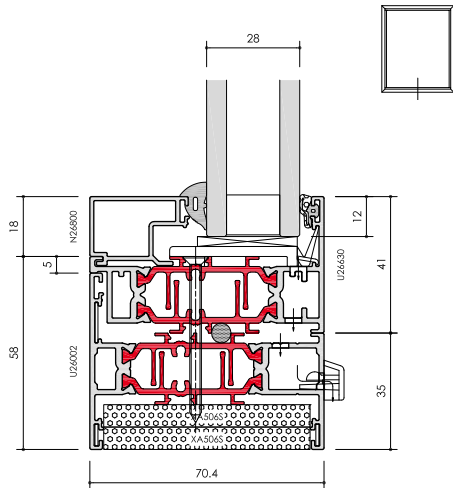

› **Curtain wall adapter detail**

Internally glazed Open-out vent over Curtain wall insert, SL50 curtain wall

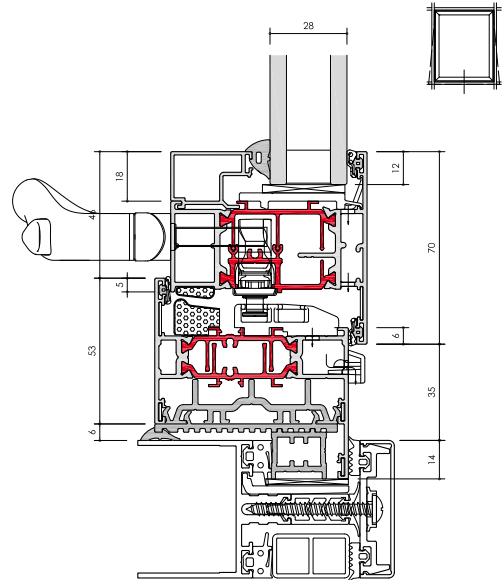

› **Z-Adapter detail**

Internally glazed Fixed Light, z-Profile, 53mm outer frame

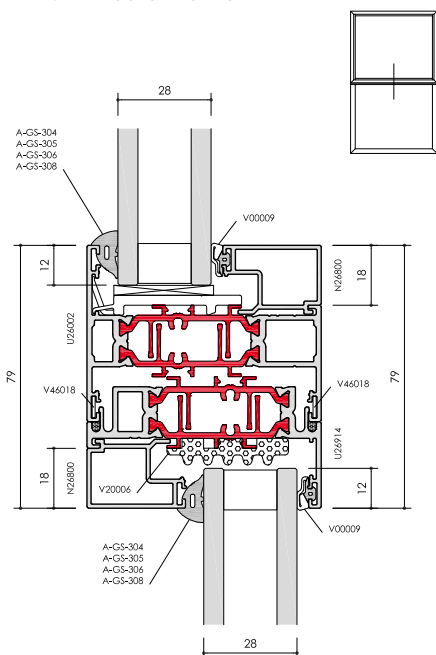

› **50mm Glazing detail**

Externally glazed Open-out vent over 53mm outer frame (50mm Glazing)

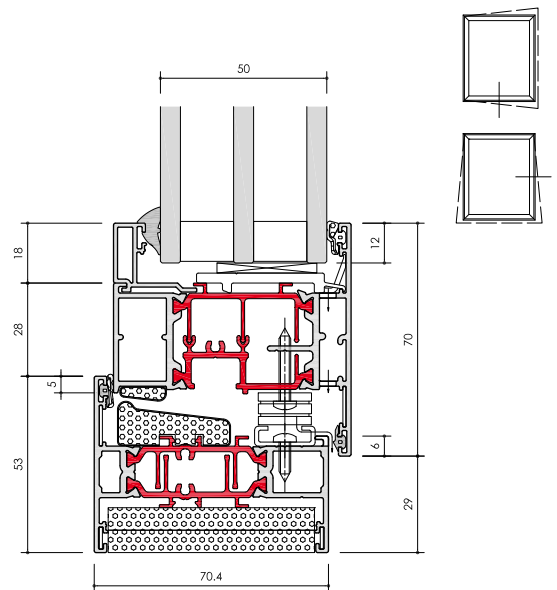

Technical Details

Ancillaries

› Sub Cill – Open-out

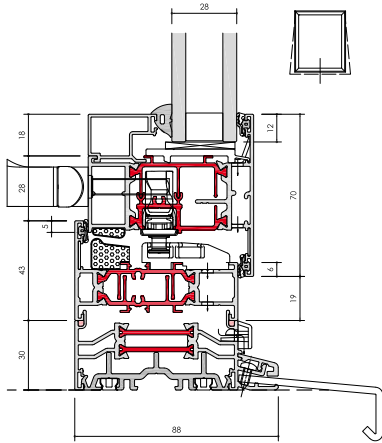

› Sub Cill – Open-in

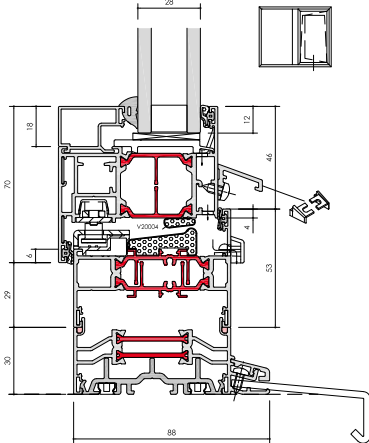

› H-Coupler

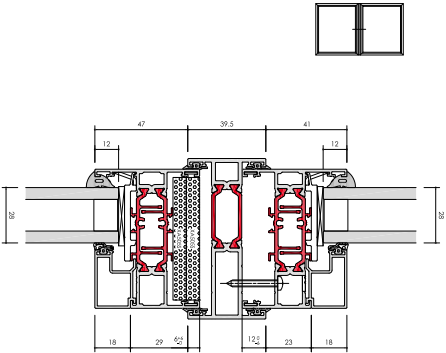

› Z-Profile

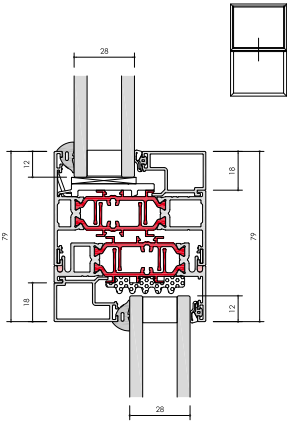

› Reinforced T-Bar Coupler

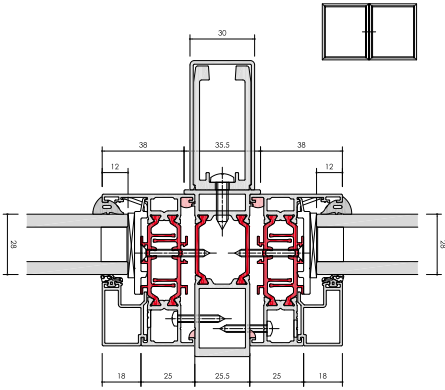

› Internal Coupler

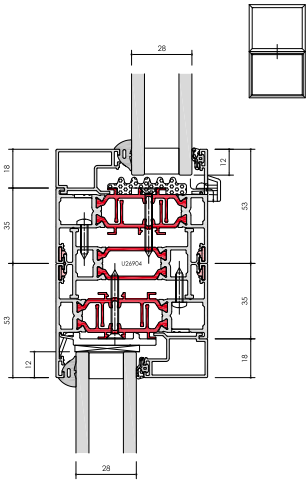

› EPDM Detail

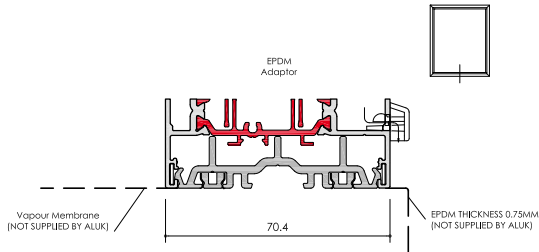



01291 639 739
info.uk@aluk.com

Registered Office

AluK (GB) Ltd
Newhouse Farm Ind Est
Chepstow
NP16 6UD

London Office

AluK Design Studio
5-11 Worship Street
London
EC2A 2BH

Registered Number

02881320