

GMDSS Radio Station

for Sea Area A3

Radio console with 150W or 250 W MF/HF,
2 Inmarsat Mini C and VHF according to SOLAS/
IMO and ITU regulations, ETS and IEC standards



GMDSS Radio Station

for Sea Area A3

Raytheon Anschütz GMDSS radio stations have been designed to meet all international standards and requirements of the user, ensuring easy ergonomic operation. The consoles are tailor-made according to the needs of our customers, because each project is different, just like their owners. Therefore it is also possible to integrate a Fleet 77 or Fleet Broadband system into the radio console.

The A3 consoles are equipped with one VHF-DSC (semi-duplex, optional full-duplex) radio. A second VHF is foreseen in the conning position of the vessel, one MF/HF-radiotelephone 150W (optional 250W) with DSC receiver and two Inmarsat C systems with full coverage of Inmarsat C services.

For greatly facilitated service and maintenance the consoles are fitted with service doors. The pre-wiring consoles minimize installation time on existing vessels and new builds and contain battery panels, power alarm monitoring, emergency light and power switch (main / emergency). Alarm muting button, large tactile buttons knobs for volume and squelch are standard features of the Raytheon Anschütz GMDSS Radio Station A3.

VHF Radiotelephone

The semi-duplex (optional full-duplex) DSC radio can store and replay incoming calls (up to 90 sec). So a missed message can simply be heard again. A standard interface for Voyage Data Recorder is included.

MF/HF Radiotelephone

A 150 W or 250 W radio (with 1 channel watch receiver) for voice communication. Radio-telex (direct typing) and 6 channel watch receiver can be added optional.

Inmarsat Mini C

One or two Inmarsat communication system (s) including telex, e-mail, SMS, EGC reception and distress message handling.

The operation control is done via the 10.4 inch message terminal / keyboard. The transceiver is coming with integrated GPS receiver of own ship's position data.

For the secondary Inm Mini C system the LRIT (Long Range Identification and Tracking) function is included. The upgrade for SSAS is also possible.

Control Unit MF/HF CU 5100



Control Unit VHF RT 5022



GMDSS Radio Station A3 according to SOLAS/IMO and ITU regulations, ETS and IEC standards



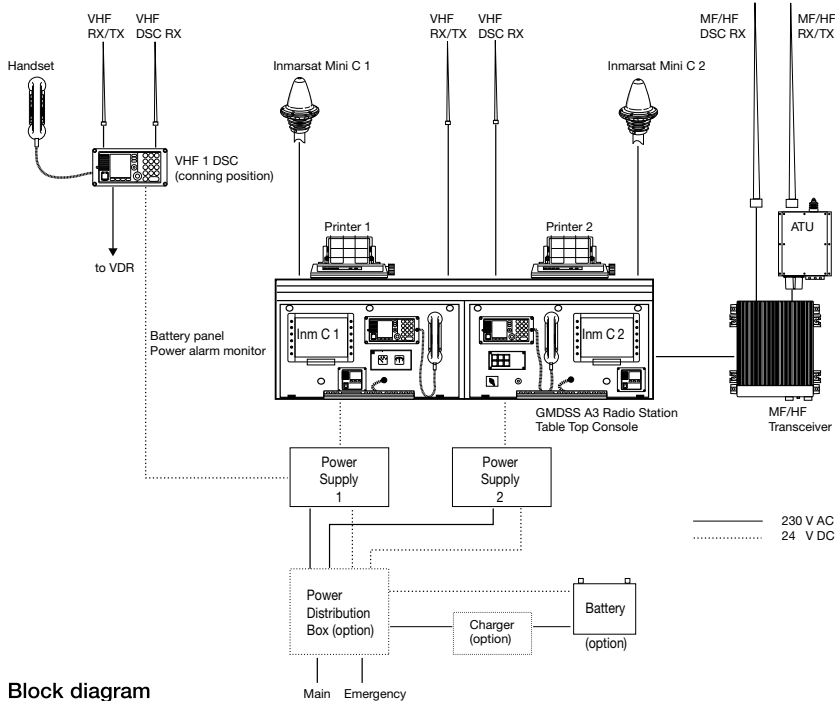

Block diagram

Technical Data

MF/HF Station for voice and DSC (Digital Selective Calling) data (optional radio-telex)

- Frequency range**
- Rx 150 kHz to 30 MHz
 - Tx 1605 kHz to 30 MHz
- Output power**
- 150 W / 250 W PEP
- Modulation**
- SSB - J3E
 - DSC - J2B
 - AM - A3E

VHF Station

RT5022 (semi-duplex) VHF-Radio with integrated DSC-watch-keeping receiver

- Frequency range**
- All international and US channels up to 30 private channels
 - 149.3 MHz to 163.7 MHz
- Output power**
- 25 W PEP / 1W
- Modulation**
- G3E for telephony
 - G2B for DSC

Satcom Inmarsat Mini C

Inmarsat Mini C-Ship Earth Station with automatic Message- and EGC (Enhanced Group Calling) -Reception. Integrated GPS Receiver

- Frequency range**
- Rx 1525.0 MHz to 1559.0 MHz
 - Tx 1626.5 MHz to 1660.5 MHz
- Data rate**
- 600 Bit per sec.

Specification Standards

Complies with the
Directive 96/98/EC and
Directive 2002/75/EC

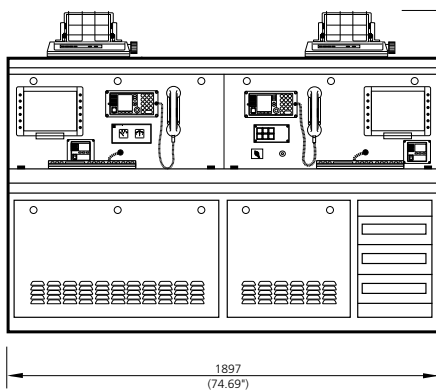

GMDSS A3 Radio Station Large Deckstand

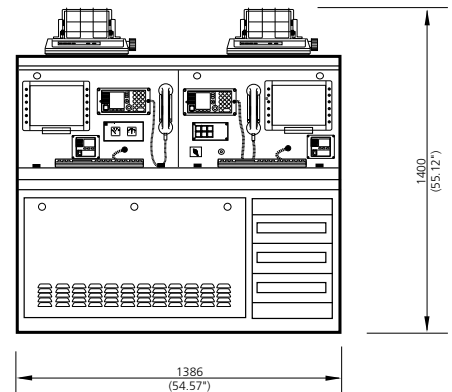
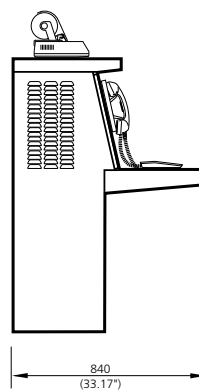

GMDSS A3 Radio Station Small Deckstand

Your Benefits

- ruggedized compact design
- fast and easy installation
- compact VHF/DSC-radio for conning position
- easy and intelligent operation
- integrated power and alarm monitoring
- built-in DSC and DSC watch-keeping receiver
- worldwide service network

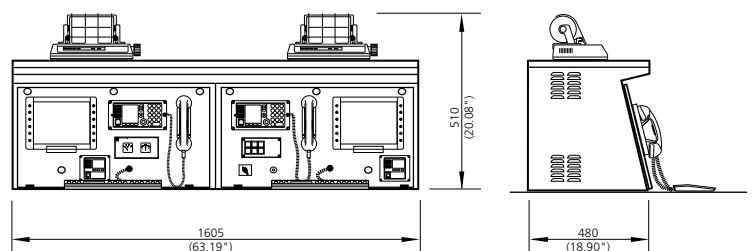

GMDSS A3 Radio Station Table Top

Parts for external mounting

either 150 W MF/HF Transceiver or 250 W MF/HF Transceiver
(table top console external)

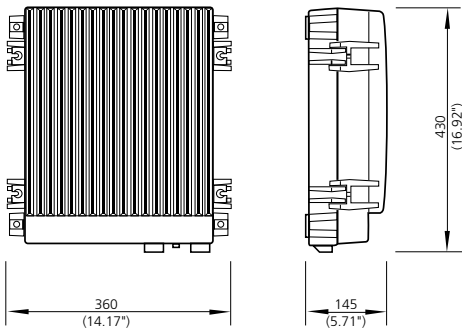

150 W MF/HF Transceiver
Weight 19 kg

for antenna deck installation

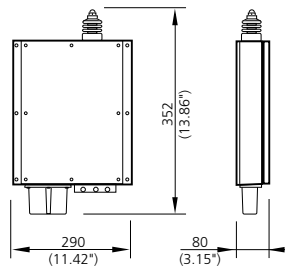

Antenna Tuning Unit (ATU)
Weight 3.3 kg

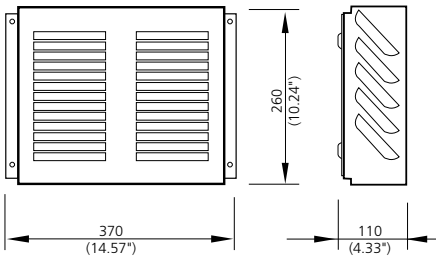

AC Power Supply
Weight 5 kg

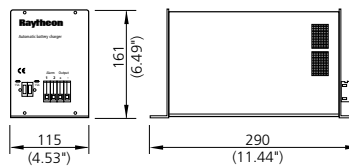

Battery Charger
Weight 3.5 kg

in conning position

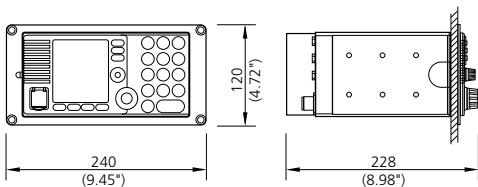

Control Unit VHF RT 5022
Weight 3.6 kg

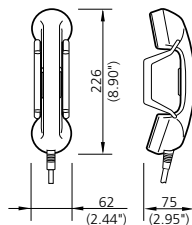

VHF-Handset
Weight 0.4 kg incl. holder

on mast top

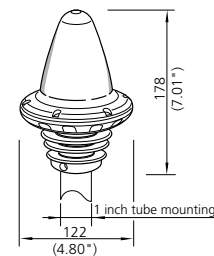

Inmarsat C TT-3005 M Antenna
Weight 0.9 kg

Subject to change due to technical developments without notice.