



+1 877 - 228 - 6616
sales@broadconnect.ca
www.broadconnect.ca



User Guide for the Polycom[®] SoundStation[®] IP 7000 Phone

SIP 3.1.1

November, 2008 Edition
1725-40075-001 Rev. B
SIP 3.1.1



Trademark Information

Polycom®, the Polycom logo design, SoundPoint® IP, SoundStation®, SoundStation VTX 1000®, ViaVideo®, ViewStation®, and Vortex® are registered trademarks of Polycom, Inc. Conference Composer™, Global Management System™, HDX 4000™, HDX 7000™, HDX 8000™, HDX 9000™, HDX 9001™, HDX 9002™, HDX 9004™, Instructor RP™, iPower™, MGC™, PathNavigator™, People+Content™, PowerCam™, Pro-Motion™, QSX™, ReadiManager™, Siren™, SoundStructure™, StereoSurround™, V2IU™, Visual Concert™, VS4000™, VSX™, and the industrial design of SoundStation are trademarks of Polycom, Inc. in the United States and various other countries. All other trademarks are the property of their respective owners.

Patent Information

The accompanying product is protected by one or more U.S. and foreign patents and/or pending patent applications held by Polycom, Inc.

Disclaimer

Some countries, states, or provinces do not allow the exclusion or limitation of implied warranties or the limitation of incidental or consequential damages for certain products supplied to consumers, or the limitation of liability for personal injury, so the above limitations and exclusions may be limited in their application to you. When the implied warranties are not allowed to be excluded in their entirety, they will be limited to the duration of the applicable written warranty. This warranty gives you specific legal rights which may vary depending on local law.

Copyright Notice

Portions of the software contained in this product are:

Copyright © 1998, 1999, 2000 Thai Open Source Software Center Ltd. and Clark Cooper

Copyright © 1998 by the Massachusetts Institute of Technology

Copyright © 1998-2003 The OpenSSL Project

Copyright © 1995-1998 Eric Young (eay@cryptsoft.com). All rights reserved

Copyright © 1995-2002 Jean-Loup Gailly and Mark Adler

Copyright © 1996-2004, Daniel Stenberg, <daniel@haxx.se>

Permission is hereby granted, free of charge, to any person obtaining a copy of this software and associated documentation files (the "Software"), to deal in the Software without restriction, including without limitation the rights to use, copy, modify, merge, publish, distribute, sublicense, and/or sell copies of the Software, and to permit persons to whom the Software is furnished to do so, subject to the following conditions:

The above copyright notice and this permission notice shall be included in all copies or substantial portions of the Software.

THE SOFTWARE IS PROVIDED "AS IS", WITHOUT WARRANTY OF ANY KIND, EXPRESS OR IMPLIED, INCLUDING BUT NOT LIMITED TO THE WARRANTIES OF MERCHANTABILITY, FITNESS FOR A PARTICULAR PURPOSE AND NONINFRINGEMENT. IN NO EVENT SHALL THE AUTHORS OR COPYRIGHT HOLDERS BE LIABLE FOR ANY CLAIM, DAMAGES OR OTHER LIABILITY, WHETHER IN AN ACTION OF CONTRACT, TORT OR OTHERWISE, ARISING FROM, OUT OF OR IN CONNECTION WITH THE SOFTWARE OR THE USE OR OTHER DEALINGS IN THE SOFTWARE.

© 2008 Polycom, Inc. All rights reserved.

Polycom Inc.
4750 Willow Road
Pleasanton, CA 94588-2708
USA

No part of this document may be reproduced or transmitted in any form or by any means, electronic or mechanical, for any purpose, without the express written permission of Polycom, Inc. Under the law, reproducing includes translating into another language or format.

As between the parties, Polycom, Inc. retains title to, and ownership of, all proprietary rights with respect to the software contained within its products. The software is protected by United States copyright laws and international treaty provision. Therefore, you must treat the software like any other copyrighted material (e.g. a book or sound recording).

Every effort has been made to ensure that the information in this manual is accurate. Polycom, Inc. is not responsible for printing or clerical errors. Information in this document is subject to change without notice.

About This Guide

Thank you for choosing the Polycom® SoundStation® IP 7000 conference phone. This conference phone provides multi-person audio and video conferencing capabilities for medium to large conference rooms within a Session Initiation Protocol (SIP) internet telephony system.

This guide provides everything you need to quickly use your new conference phone. Verify with your system administrator that the network is prepared for configuring the conference phone. Also, read the Parts List and the Safety and Compliance section in this guide before you set up and use the conference phone.

This guide includes regulatory compliance information that your system administrator should review. You can also view this guide at www.polycom.com/voicedocumentation.

Changes to this Guide

The following sections are new for this edition:

- [Connecting Optional Video Components](#) on page 1-11
- [Registering the Phone](#) on page 1-14
- [Using the Phone When it is Connected to a Polycom HDX System](#) on page 4-7

Major changes have occurred to the following sections since the previous edition:

- [Optional Accessories](#) on page 1-2
- [Connecting Optional External Microphones](#) on page 1-8
- [Adding Contacts to Your Local Contact Directory](#) on page 2-19
- [Placing Calls](#) on page 3-2
- [Restarting the Phone](#) on page 4-26

Contents

About This Guide	iii
Changes to this Guide	iii
1 Getting Started with Your Phone	1-1
Parts List	1-2
Optional Accessories	1-2
Installing the Phone	1-3
Connecting Network and Power Sources	1-3
Connecting the Phone Using a Power over Ethernet Source ...	1-3
Connecting the Phone Using AC Power (One Phone)	1-4
Connecting the Phone Using AC Power (One Phone, with Multi-Interface Module)	1-5
Connecting the Phone Using AC Power (Two Phones, with Multi-Interface Module)	1-6
Connecting Optional External Microphones	1-8
Connecting Optional Auxiliary Audio Components	1-9
2.5mm Audio Connector on Phone	1-10
Audio Connectors on Multi-Interface Module	1-11
Connecting Optional Video Components	1-11
Registering the Phone	1-14
Before You Use Your Phone	1-14
Features of the Phone	1-15
Understanding Icons	1-18
Navigating Menus and Entering Data	1-20
2 Customizing Your Phone	2-1
Configuring Basic Settings	2-1
Updating Preferences	2-2
Updating the Language	2-2
Updating the Time and Date Display	2-3
Updating the Display Contrast	2-6
Updating the Backlight Intensity	2-6

Updating the Ring Tone	2-8
Selecting a Different Ring Tone for Your Phone	2-9
Setting Distinctive Ring Tones for Contacts	2-9
Updating Audio Quality and Capabilities	2-11
Updating the Sound Quality of Your Phone	2-11
Enabling Auxiliary Audio Components	2-12
Adjusting the Speaker and Ringer Volume	2-14
Using Call Lists	2-14
Viewing Call Lists	2-15
Managing Call Lists	2-15
Managing Contacts	2-17
Adding Contacts to Your Local Contact Directory	2-19
Adding Contacts Manually	2-19
Adding Contacts From Call Lists	2-21
Adding Contacts to Your Local Contact Directory From a Corporate Directory	2-22
Searching for Contacts	2-23
Searching for Contacts in Your Local Contact Directory	2-23
Searching for Contacts in a Corporate Directory	2-24
Updating Contacts in Your Local Contact Directory	2-26
Deleting Contacts From Your Local Contact Directory	2-27
Placing Calls to Contacts	2-27
Managing Incoming Calls	2-28
Distinguishing Calls	2-28
Rejecting Calls	2-28
Diverting Calls	2-29
Understanding Shared Lines	2-30

3 Using the Basic Features of Your Phone 3-1

Placing Calls	3-2
Answering Calls	3-6
Ending Calls	3-6
Muting the Microphone	3-7
Redialing Numbers	3-7
Holding and Resuming Calls	3-8
Hosting Conference Calls	3-9
Setting Up Conferences	3-9
Managing Conferences	3-11
Muting Conference Call Participants	3-12
Placing Conference Call Participants on Hold	3-13
Removing Conference Call Participants	3-14
Obtaining Information About Conference Call Participants ..	3-14

Holding and Resuming Conferences	3-15
Splitting Conferences	3-16
Ending Conferences	3-16
Transferring Calls	3-16
Performing a Consultative Transfer	3-17
Performing a Blind Transfer	3-18
Forwarding Calls	3-19
Forwarding Calls Statically	3-19
Forwarding Calls Dynamically	3-21
Enabling Do Not Disturb	3-21
Managing Speed Dial Entries	3-23
Using Voice Mail	3-24

4 Using the Advanced Features of Your Phone 4-1

Using Computer or Mobile Audio with the Conference Phone	4-1
Listening to Computer or Mobile Audio	4-2
Ending Computer or Mobile Audio	4-5
Placing Computer or Mobile Audio on Hold	4-5
Creating Conference Calls with Computer or Mobile Audio	4-5
Adjusting the Volume of Computer or Mobile Audio	4-6
Using the Phone When it is Connected to a Polycom HDX System	4-7
Placing Calls When Your Phone is Connected to a Polycom HDX System	4-9
Placing Calls When You Don't Have Any Active Calls	4-9
Placing Calls When You Have an Audio-Only Call on Hold	4-10
Placing Calls When You Have an Active Audio-only Call or a Video Call	4-11
Placing Calls Using Call Lists, Directories, Speed Dial Index Numbers, and the Redial Key When Your Phone is Connected to a Polycom HDX System	4-11
Answering Calls When Your Phone is Connected to a Polycom HDX System	4-11
Answering Calls When You Don't Have Any Active Calls ...	4-11
Answering Calls When You Have an Audio-Only Call on Hold	4-12
Answering Calls When You Have an Active Call	4-12
Ending Calls When Your Phone is Connected to a Polycom HDX System	4-13
Holding Calls When Your Phone is Connected to a Polycom HDX System	4-13
Transferring Calls When Your Phone is Connected to a Polycom HDX System	4-13

Forwarding Calls When Your Phone is Connected to a Polycom HDX System	4-14
Enabling Do Not Disturb When Your Phone is Connected to a Polycom HDX System	4-14
Rejecting Calls When Your Phone is Connected to a Polycom HDX System	4-14
Hosting Conference Calls When Your Phone is Connected to a Polycom HDX System	4-14
Setting Up Conferences	4-15
Handling Active Conferences	4-16
Managing Conferences	4-17
Controlling Volume and Muting Calls When Your Phone is Connected to a Polycom HDX System	4-17
Showing Content When Your Phone is Connected to a Polycom HDX System	4-18
Handling Multiple Call Appearances When Your Phone is Connected to a Polycom HDX System	4-18
Handling Computer or Mobile Audio When Your Phone is Connected to a Polycom HDX System	4-19
Handling Multiple Call Appearances	4-19
Using Buddy Lists	4-20
Updating Presence Settings	4-20
Selecting Contacts to Monitor	4-21
Blocking Contacts From Viewing Your Status	4-22
Monitoring the Status of Contacts in Your Buddy List	4-24
Integrating With Microsoft Office Live Communications Server 2005	4-25
Restarting the Phone	4-26

5 Troubleshooting Your Phone 5-1

Installation Configuration	5-2
Power and Startup	5-3
Controls	5-4
Access to Screens and Systems	5-5
Calling	5-6
Displays	5-7
Audio	5-7
Testing Phone Hardware	5-7

Safety Notices Safety Notices-1

Index Index-1

Getting Started with Your Phone

This chapter provides basic installation instructions and information for obtaining the best performance from your SoundStation IP 7000 conference phone.

The SoundStation IP 7000 conference phone is a next-generation phone with a modern industrial design, and the latest advancements in Polycom voice technology.

Some of the key features of the phone include:

- Extraordinary audio performance
- Strong IP telephony feature set
- Built-in voice bridge for multi-participant conferences
- Ability to connect two phones together for convenience, performance, and flexibility
- Ability to connect to Polycom HDX systems to conduct video calls and conferences
- A port built into the console to allow calls from a computer calling application or a mobile phone

This chapter includes the following topics:

- [Parts List](#) on page 1-2
- [Installing the Phone](#) on page 1-3
- [Registering the Phone](#) on page 1-14
- [Features of the Phone](#) on page 1-15
- [Understanding Icons](#) on page 1-18
- [Navigating Menus and Entering Data](#) on page 1-20

To read about how to change the settings on your phone, see Chapter 2, [Customizing Your Phone](#). To read about the phone's basic features, see Chapter 3, [Using the Basic Features of Your Phone](#). To read about more advanced features, see Chapter 4, [Using the Advanced Features of Your Phone](#).

If you require additional information or assistance with your new phone, see your system administrator.

Parts List

The following items are included in your basic phone package:

- SoundStation IP 7000 Conference Phone
- 25-foot Network Cable
- Quick Start Guide

Make sure your conference phone package contains each item. If any item is missing, see your system administrator.

SoundStation IP 7000 Conference Phone

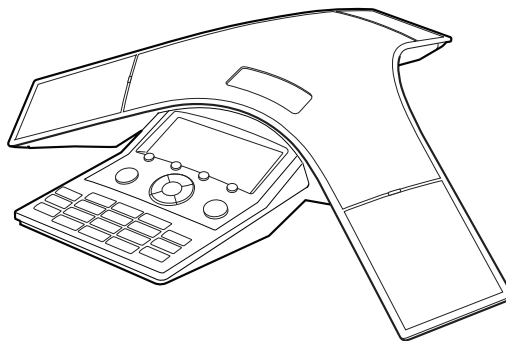

25-foot Network Cable

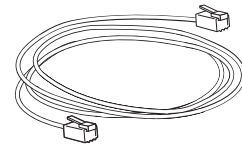

Quick Start Guide

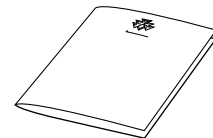

Optional Accessories

The following items are optional accessories for the phone:

- AC Power Kit with:
 - Power Adapter
 - Regional Power Cord
 - Power Insertion Cable

- Multi-Interface Module Package with:
 - Multi-Interface Module
 - 12-foot Network Cable (10-pin)
 - Power Adapter
 - Regional Power Cord
- Console Interconnect Cable
- External Microphone Kit with two SoundStation IP 7000 extended microphones
- External Microphone Kit with two Polycom HDX Microphone Arrays
- Mobile Phone Cable
- Computer Calling Kit with Computer Calling Cable
- Video Kit with a Polycom HDX Microphone Cable

Installing the Phone

This section describes how to install your phone. It includes the following topics:

- [Connecting Network and Power Sources](#) on page 1-3
- [Connecting Optional External Microphones](#) on page 1-8
- [Connecting Optional Auxiliary Audio Components](#) on page 1-9
- [Connecting Optional Video Components](#) on page 1-11

Connecting Network and Power Sources

There are four ways to connect your phone to the network and a power source. Your system administrator can tell you which of the following methods best suits your teleconferencing needs:

- Power over Ethernet (PoE)
- AC Power (One Phone)
- AC Power (One Phone, with Multi-Interface Module)
- AC Power (Two Phones, with Multi-Interface Module)

Connecting the Phone Using a Power over Ethernet Source

Power over Ethernet is the default connection for the phone.

Note

AC power adapters are not included in the PoE package. If you require one, see your system administrator.

The following figure shows how to connect the phone to the network using a PoE source.

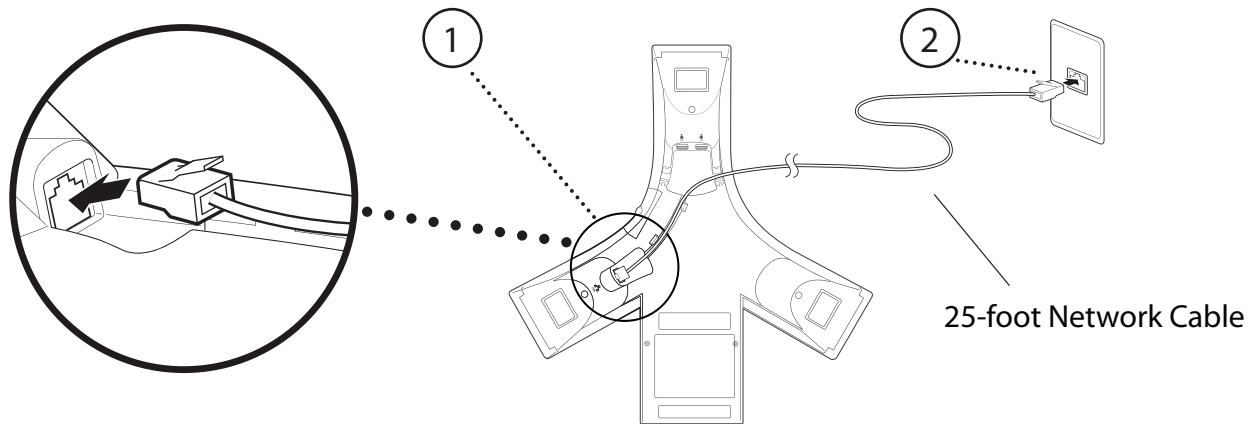

To connect the phone using a PoE source:

1. Connect the 25-foot Network Cable to the LAN jack on the phone.
2. Connect the other end of the 25-foot Network Cable to an available LAN port on the wall or hub/switch device port.

Connecting the Phone Using AC Power (One Phone)

If a PoE source is not available, connect the phone to an AC power source. To connect the phone to an AC power source, make sure you have the optional AC Power Kit (containing a Power Adapter, Regional Power Cord, and a Power Insertion Cable).

The following figure shows how to connect the phone to an AC power source.

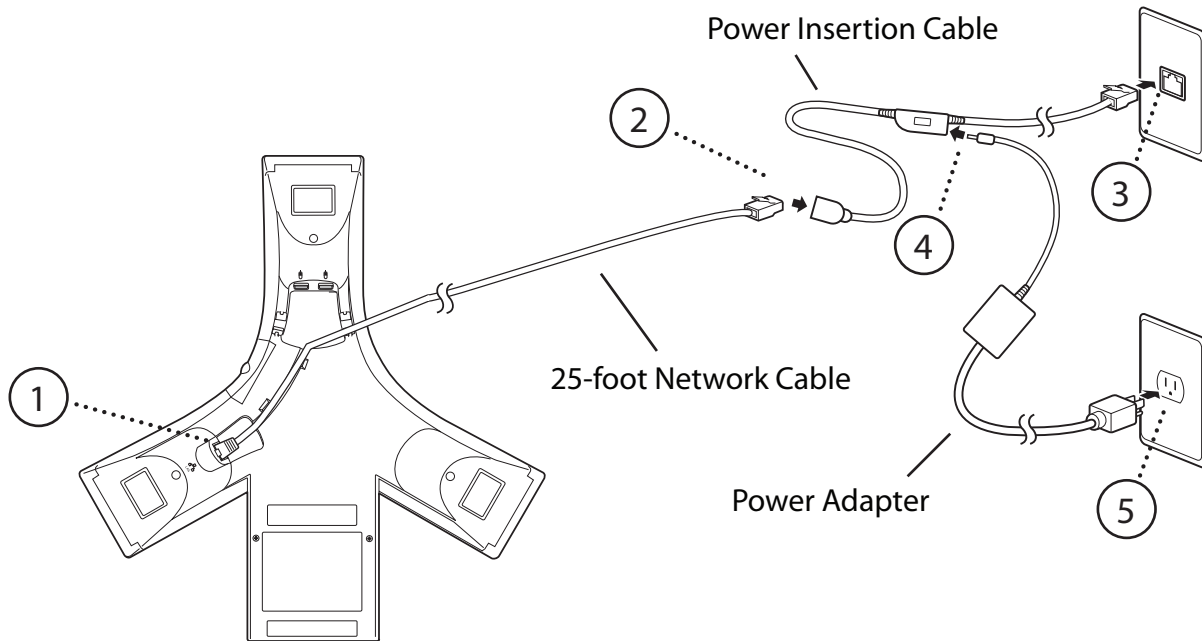

To connect the phone to an AC power source:

1. Connect the 25-foot Network Cable to the LAN jack on the phone.
2. Connect the other end of the 25-foot Network Cable to the Power Insertion Cable.
3. Connect the Power Insertion Cable to an available LAN port on the wall or hub/switch device port.
4. Connect the Power Adapter to the Power Insertion Cable.
5. Connect the other end of the Power Adapter (with the attached Regional Power Cord) to the wall outlet.

Connecting the Phone Using AC Power (One Phone, with Multi-Interface Module)

You can connect one phone to an AC power source and the Multi-Interface Module. In this way, you have access to the auxiliary audio connectors on the module so you can connect speakers, wireless (lapel) microphones, and recording devices and computers (to record phone calls).

Before you set up a phone using the Multi-Interface Module, make sure you have the optional Multi-Interface Module Package (containing a Multi-Interface Module, 12-foot Network Cable (10-pin), Power Adapter, and Regional Power Cord).

The following figure shows how to connect the phone to an AC power source and the Multi-Interface Module.

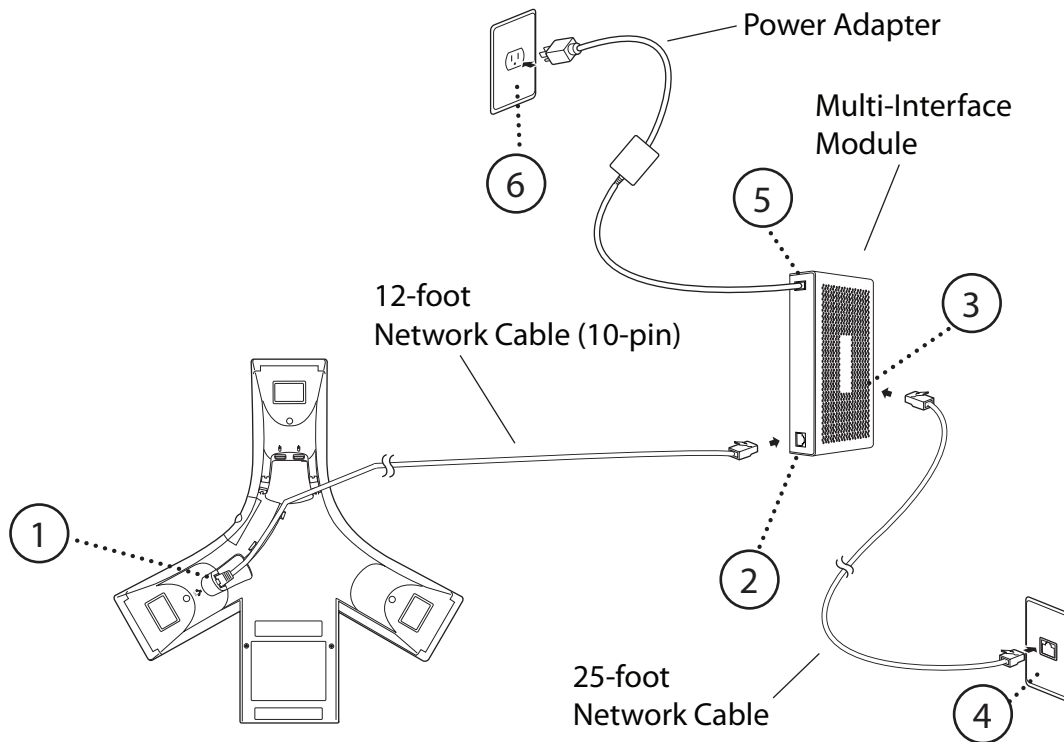

To connect the phone to an AC power source and the Multi-Interface Module:

1. Connect the 12-foot Network Cable (10-pin) to the LAN jack on the phone.
2. Connect the other end of the 12-foot Network Cable (10-pin) to the Multi-Interface Module.
3. Connect the 25-foot Network Cable to the Multi-Interface Module.
4. Connect the other end of the 25-foot Network Cable to an available LAN port on the wall or hub/switch device port.
5. Connect the Power Adapter to the Multi-Interface Module.
6. Connect the other end of the Power Adapter (with the attached Regional Power Cord) to the wall outlet.

Connecting the Phone Using AC Power (Two Phones, with Multi-Interface Module)

If you have a larger room configuration, you can connect up to two phones together. In this case, the phones act as one phone and display the same information. For more information on how to use your phone when two phones are connected, see your system administrator.

Before you connect two phones together, make sure you have the optional Multi-Interface Module Package (containing a Multi-Interface Module, 12-foot Network Cable (10-pin), Power Adapter, and Regional Power Cord) and the optional Console Interconnect Cable.

The following figure shows how to connect two phones to the network using AC power.

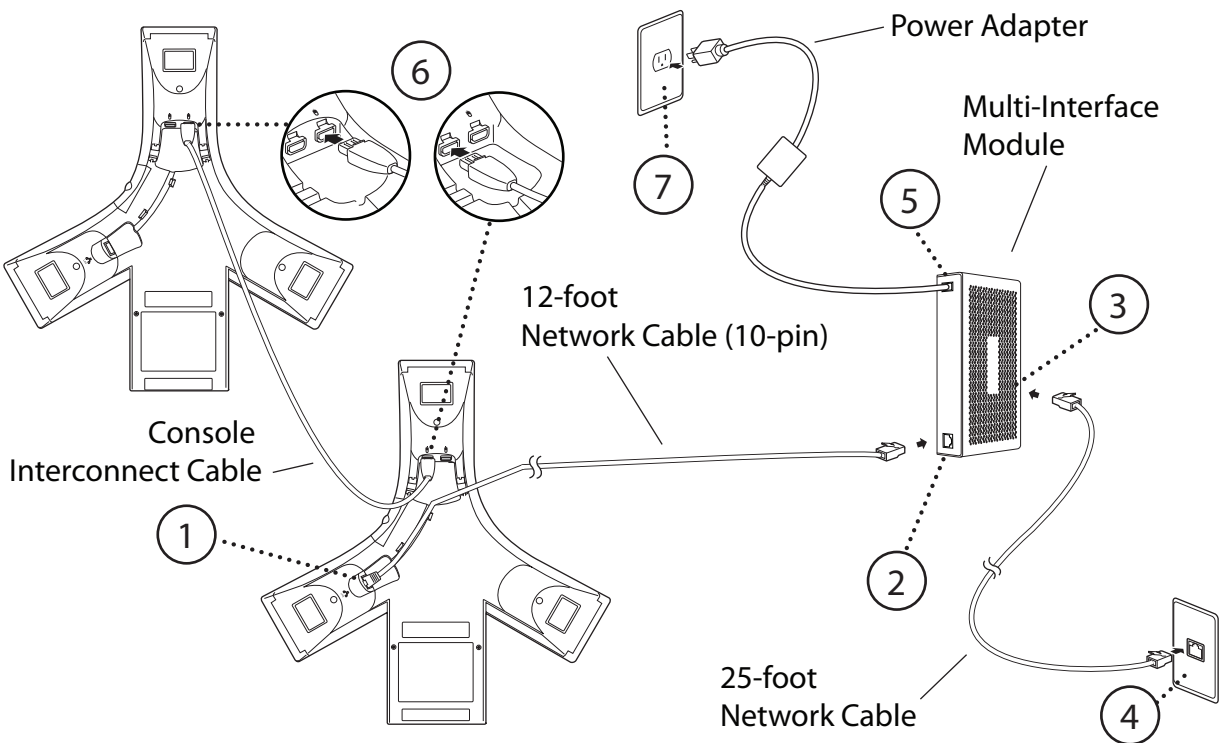

To connect two phones to an AC power source:

Warning

Make sure you connect the two phones and the Multi-Interface Module before you connect the Power Adapter (with the attached Regional Power Cord) to the wall outlet.

1. Connect the 12-foot Network Cable (10-pin) to the LAN jack on the first phone.
2. Connect the other end of the 12-foot Network Cable (10-pin) to the Multi-Interface Module.
3. Connect the 25-foot Network Cable to the Multi-Interface Module.
4. Connect the other end of the 25-foot Network Cable to an available LAN port on the wall or hub/switch device.
5. Connect the Power Adapter to the Multi-Interface Module.

6. To connect phones, plug one end of the Console Interconnect Cable into one of the microphone connectors on the first phone and the other end of the cable into one of the microphone connectors on the second phone.
7. Connect the other end of the Power Adapter (with the attached Regional Power Cord) to the wall outlet.

Connecting Optional External Microphones

You can connect microphones to the phone using an optional External Microphone Kit. Depending on the External Microphone Kit you have, your kit will contain either two SoundStation IP 7000 extended microphones (analog), or two Polycom HDX Microphone Arrays (digital).

Connect the free end of a microphone cable to one of the microphone connectors on the phone. You can connect two microphones to one phone.

The following figure shows two SoundStation IP 7000 extended microphones connected to a single phone. You would connect two Polycom HDX Microphone Arrays in the same way.

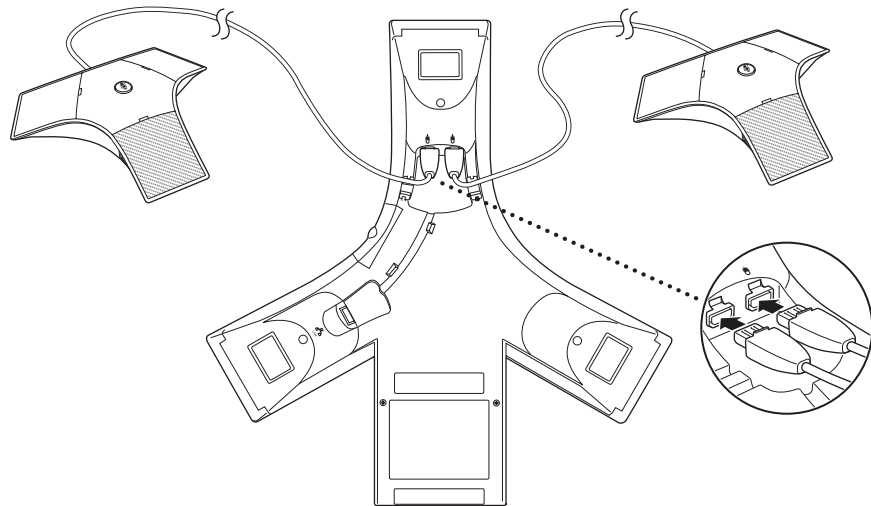

If your conference room setup has two connected phones, you can only connect one microphone to one phone (you cannot connect a microphone to each phone). Connect the free end of a microphone cable to the available microphone connector on one of the phones. It does not matter which phone you attach the microphone to.

The following figure shows a two phone setup with a SoundStation IP 7000 extended microphone. You would attach a Polycom HDX Microphone Array in the same way.

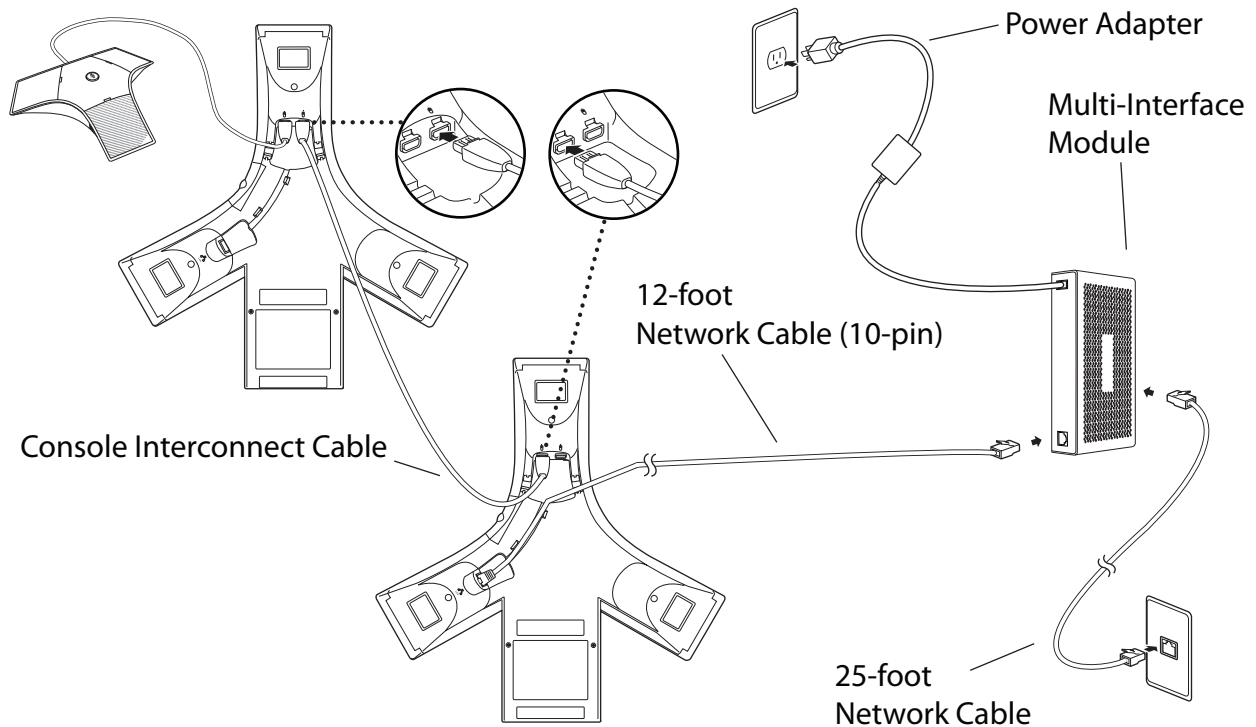

Connecting Optional Auxiliary Audio Components

You can connect various auxiliary audio components, such as wireless (lapel) microphones, speakers, and recording devices and computers (to record phone calls) to your phone. You can also connect your conference phone to audio from a mobile phone or a computer calling application. You connect audio components to one of the following connectors:

- 2.5mm audio connector on your conference phone – to hear audio from mobile phones and computer calling applications.

To connect a mobile phone to your conference phone, you require the optional Mobile Phone Cable. To connect a computer calling application to your conference phone, you require the optional Computer Calling Kit (containing a Computer Calling Cable).

- Audio connectors and ports on the Multi-Interface Module – to connect wireless (lapel) microphones, speakers, and recording devices and computers (to record phone calls).

To connect audio components to the Multi-Interface Module, see your system administrator.

After you connect an auxiliary audio component to the Multi-Interface Module, you must enable the component. To enable the component, see [Enabling Auxiliary Audio Components](#) on page 2-12.

Note

You do not have to enable audio from a mobile phone or from a computer calling application. This audio is automatically enabled when you connect the Mobile Phone Cable or the Computer Calling Cable to the 2.5mm audio connector on your conference phone.

2.5mm Audio Connector on Phone

Your conference phone has a 2.5mm audio connector to connect to a mobile phone or to a computer calling application. You connect a mobile phone or computer calling application so you can use the conference phone speaker to stream two-way audio from the mobile phone or computer calling application for hands-free conversations. When you connect mobile or computer audio to your conference phone, all participants in a call or conference call (including those connected through a mobile phone or computer calling application) can hear and speak to each other.

The 2.5mm audio connector is located on the right side of your conference phone, behind a door you flip open.

The following figure shows the 2.5mm audio connector on the side of the conference phone. The 2.5mm audio connector has a mobile phone icon above it.

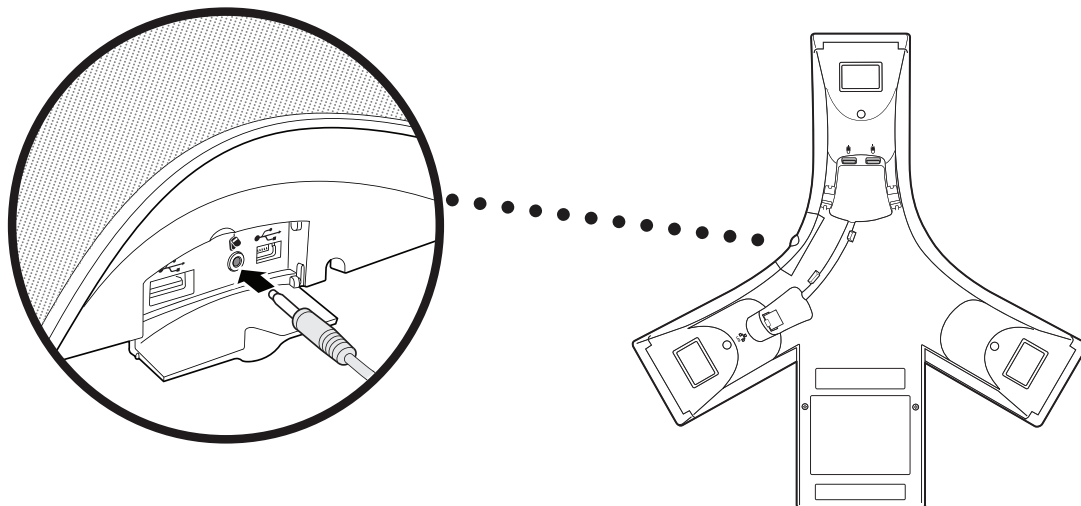

To connect to audio from a mobile phone:

- >> Connect one end of the optional Mobile Phone Cable to the headset jack on your mobile phone, and connect the other end to the 2.5mm audio connector on your conference phone.

Note

If your conference phone setup has two connected phones, you can attach the Mobile Phone Cable to either conference phone.

For information on using your conference phone with a mobile phone connection, see [Using Computer or Mobile Audio with the Conference Phone](#) on page 4-1.

To connect to audio from a computer calling application:

- >> Connect one end (the end with two connectors) of the Computer Calling Cable (contained in the optional Computer Calling Kit) to the sound card on your computer, and connect the other end to the 2.5mm audio connector on your phone.

For information on using your phone with a computer calling application, see [Using Computer or Mobile Audio with the Conference Phone](#) on page 4-1.

Audio Connectors on Multi-Interface Module

The Multi-Interface Module has various connectors and ports to connect wireless (lapel) microphones, speakers, and recording devices and computers (to record phone calls). To attach and use audio components, see your system administrator.

Connecting Optional Video Components

You can connect your phone to a Polycom HDX system so that your phone can conduct video calls and conferences. You can connect your phone to the following Polycom HDX systems running 2.5 or later:

- Polycom HDX 4000™ series
- Polycom HDX 7000™ series
- Polycom HDX 8000™ HD
- Polycom HDX 9000™ series

For information on how to use your phone when it is connected to a Polycom HDX system, see [Using the Phone When it is Connected to a Polycom HDX System](#) on page 4-7. For detailed information on how to use a Polycom HDX system, see the Polycom HDX documentation at www.polycom.com/videodocumentation.

Before you set up your phone to connect to a Polycom HDX system, make sure you have the optional Video Kit (containing a Polycom HDX Microphone Cable). You use the Polycom HDX Microphone Cable to connect your phone to the Polycom HDX system.

When you connect your phone to a Polycom HDX system, you do not need to connect the phone to a power source. The Polycom HDX system provides the power source.

To connect your phone to a Polycom HDX system:

Note

You can only connect a single-phone setup to the Polycom HDX system. That is, you cannot connect two phones together (using the Console Interconnect Cable), and then connect the phones to a Polycom HDX system.

1. Connect your phone to the network:

Note

If you are using a Multi-Interface Module, follow the steps for [Connecting the Phone Using AC Power \(One Phone, with Multi-Interface Module\)](#) on page 1-5, and then go to step 2.

- a** Connect the 25-foot Network Cable to the LAN jack on the phone.
- b** Connect the other end of the 25-foot Network Cable to an available LAN port on the wall or hub/switch device port.

The following figure shows how to connect the phone to the network.

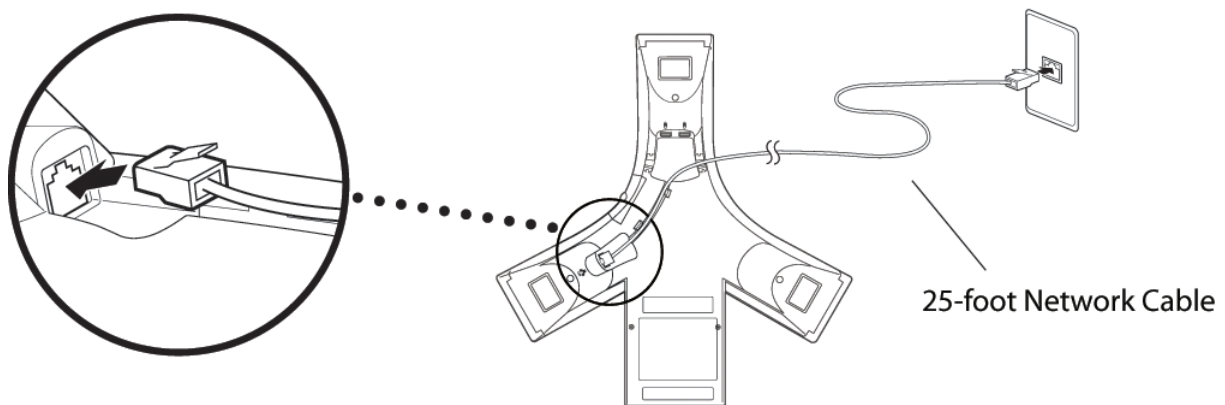

- 2.** (Optional.) Connect an external microphone or auxiliary audio components to your phone. See [Connecting Optional External Microphones](#) on page 1-8 and [Connecting Optional Auxiliary Audio Components](#) on page 1-9.

Note

You can only connect one external microphone to your phone. The other microphone connector on your phone must be available to connect to the Polycom HDX system.

You may be able to connect additional Polycom HDX Microphone Arrays to the Polycom HDX system (the exact number depends on the Polycom HDX system you have). To find out how many Polycom HDX Microphone Arrays you can connect to your system, see the “optional setup” instructions in the setup guide for your system at www.polycom.com/vidoeodocumentation.

3. Connect one end of the Polycom HDX Microphone Cable into an available microphone connector on your phone, and connect the other end to the Polycom HDX system.

The following figure shows how to connect the Polycom HDX Microphone Cable to an available microphone connector on your phone. The other end of the cable connects to the Polycom HDX system.

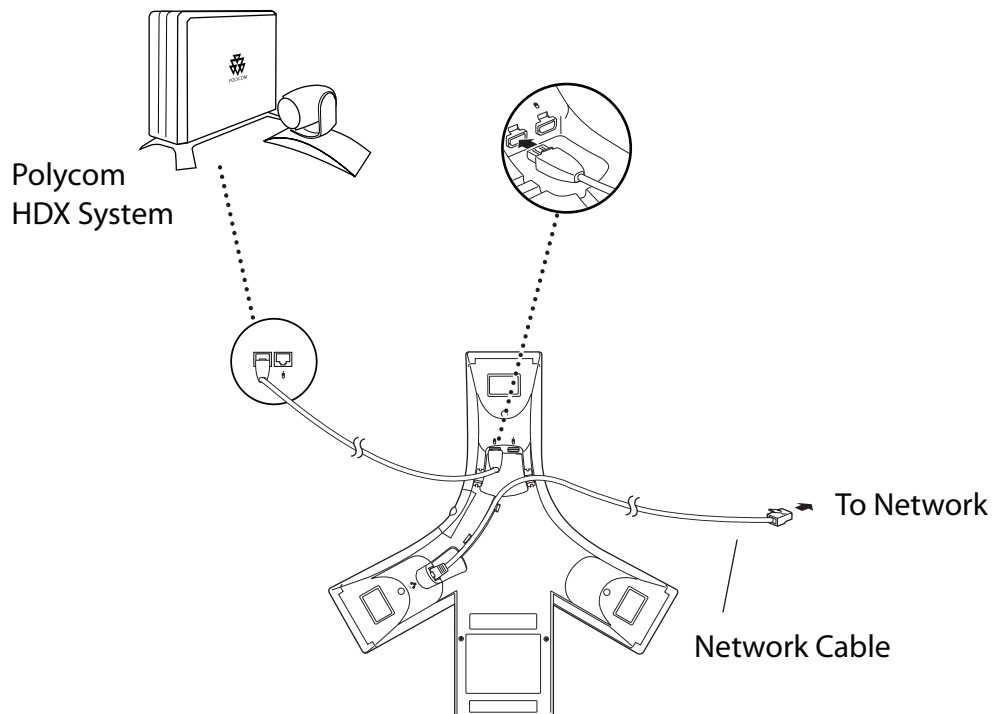

Registering the Phone

Generally, your phone will be deployed with multiple other phones. In this case, your system administrator will configure the phone parameters beforehand, so that after you set up your phone, the phone will be registered and ready to use.

If your phone is not part of a large phone deployment, your phone may not be registered after you set it up. Before you use your phone, you or your system administrator will have to register it.

For detailed information on how to register your phone after you install it, see *Quick Tip 44011: Registering Standalone SoundPoint IP and SoundStation IP Phones*, available at http://www.polycom.com/usa/en/support/voice/soundpoint_ip/VoIP_Technical_Bulletins_pub.html

Before You Use Your Phone

Note

Since you can customize your phone in many different ways, and your system administrator can enable and disable certain features, the user interface that displays on your phone may differ from the figures that appear in this guide.

Before you use your phone, familiarize yourself with the phone's features, the icons that display on the screen, and how to navigate menus and enter data.

Features of the Phone

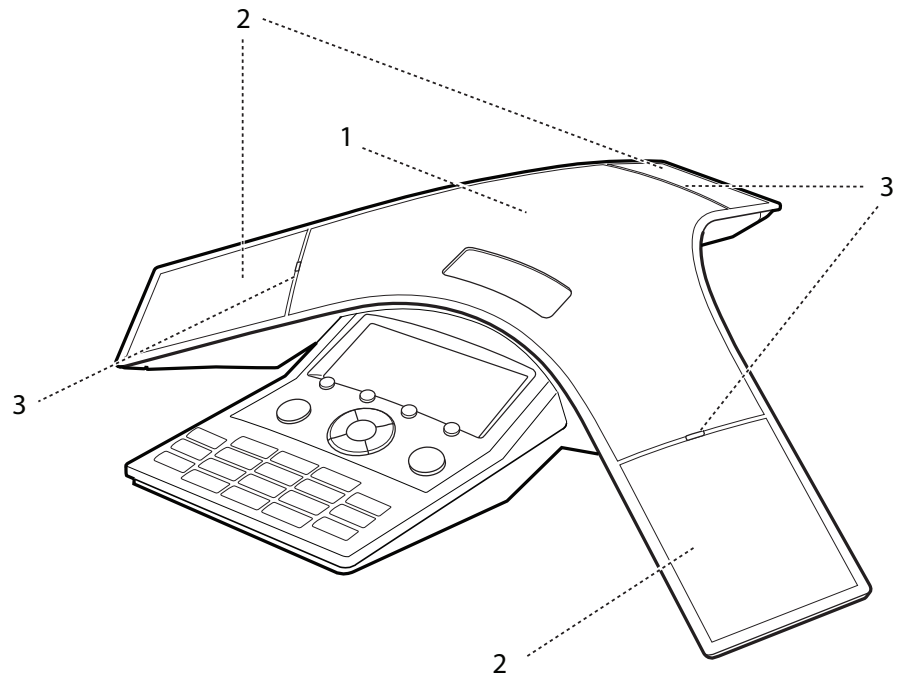

The following figure shows the primary hardware features of your phone console.





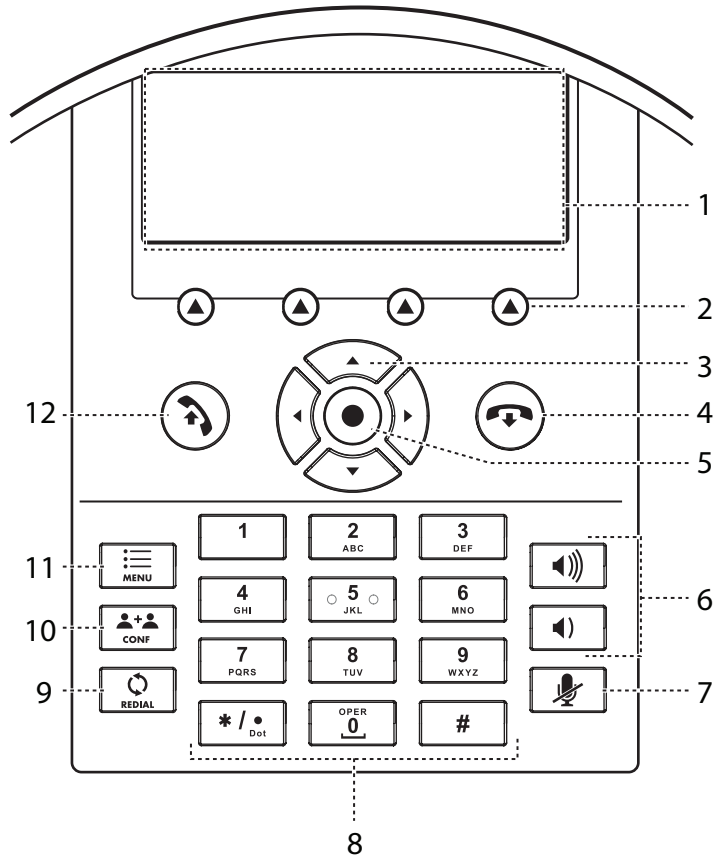





	Feature	Description
1	Speaker	Allows for ringer and hands-free audio output.
2	Microphones	Provide 360° coverage by three internal microphones.
3	LED Indicators	Indicate phone and call status through three bi-color LEDs. The LEDs illuminate to indicate the following normal operational states: <ul style="list-style-type: none"> • Solid red—A muted call • Flashing red—A call is on hold • Solid green—A dial-tone is available, dialing is in-progress, or call is in-progress • Flashing green—An incoming call





























The following figure shows the primary components on your phone console:













	Item	Description
1	LCD graphic display	Shows call and status information, messages, soft keys, menus, time, and date.
2	Soft keys 	Select specific context-sensitive functions that display on the screen above each soft key.
3	Scroll keys 	Allow you to: <ul style="list-style-type: none"> • Scroll through displayed information • Enable or disable fields • View the Speed Dial Info list (Up scroll key) • View the Received Calls list (Left scroll key) • View the Placed Calls list (Right scroll key) • View the Missed Calls list (Down scroll key)

	Item	Description
4	End Call key 	Ends a call.
5	Select key 	Allows you to: <ul style="list-style-type: none"> • Select a field of displayed data • Enable or disable fields
6	Volume keys 	Adjust the volume of the speaker and the ringer.
7	Mute key 	Stops local audio from being heard at the far end of the call.
8	Dial pad keys	Contain 10 digits, 26 alphabetic characters, and other special characters available in context-sensitive applications.
9	Redial key 	Places a call to the most recently dialed person.
10	Conference key 	Allows you to set up local audio conferences.
11	Menu key 	Allows you to access additional features and configuration settings.
12	Make Call key 	Initiates a call.

Understanding Icons

Icon	Line, Call State, or Indicator	Description												
	Active call using Polycom® HD Voice™ technology	A call is in progress using Polycom HD Voice. The active call icons merge into one icon on the phone screen. The following figure shows what displays on the screen during an active call: <table border="1" data-bbox="901 552 1268 674"> <tr> <td></td> <td></td> <td></td> <td></td> <td></td> <td></td> </tr> <tr> <td>HD</td> <td>HD</td> <td>HD</td> <td>HD</td> <td>HD</td> <td></td> </tr> </table>							HD	HD	HD	HD	HD	
														
HD	HD	HD	HD	HD										
	Active call not using Polycom HD Voice	A call in is progress that does not use Polycom HD Voice.												
	Audio-only call	An audio-only call is either active or on hold, or the phone is placing a call. In lists, the icon represents an audio-only call.												
	Call forward	You have enabled the call forward feature on your phone. See Forwarding Calls on page 3-19.												
	Conference	A conference is in progress. See Hosting Conference Calls on page 3-9.												
	Dialing	The phone is placing a call.												
	Hold	A call or conference is on hold. See Holding and Resuming Calls on page 3-8 and Holding and Resuming Conferences on page 3-15.												
 	Do Not Disturb	You have enabled the Do Not Disturb feature on your phone. Your phone will not ring. See Enabling Do Not Disturb on page 3-21.												
	Far mute	You have applied the far mute feature to a conference call participant. The muted participant can hear all participants, but no participant can hear the muted participant. See Muting Conference Call Participants on page 3-12.												







Icon	Line, Call State, or Indicator	Description
	Presence	Identifies the status of a buddy in your Buddy Status list. See Using Buddy Lists on page 4-20.  – Online  – Busy or On the phone  – Be right back, Away, or Out to lunch  – Offline
	Registered line	The phone can place and receive calls.
	Registered shared line	The phone, which shares a directory number with another phone, can place and receive calls. See Understanding Shared Lines on page 2-30.
	Ringing	The phone is ringing.
	Unregistered line	The phone is unable to place and receive calls.
	Video call	A video call is taking place, or the phone is placing a video call. In lists, the icon represents a video call.
	Voice mail message	You have a new voice mail message. See Using Voice Mail on page 3-24.







Navigating Menus and Entering Data

To navigate menus and enter data, use the following tips.

Note

After 20 seconds of inactivity, the menu system automatically exits to the idle screen unless an edit session is in progress.

If you want to ...	Then do this ...
Enter the Main Menu	Press  .
Exit the Main Menu and return to the idle screen	Press  .
Exit the Main Menu or Directories menu	Press the Exit soft key.
Return to the previous menu	Press the Back soft key.
Cancel the current task or edit session	Press the Cancel soft key.
Scroll through a list or menu items	<p>Press the Up and Down scroll keys:</p> <p> and  .</p> <p>When lists appear on more than one page, press the * key to Page Up, or press the # key to Page Down.</p>
Select a menu item	<p>Do one of the following:</p> <ul style="list-style-type: none"> • Scroll to the menu item, and then press  . • Scroll to the menu item, and then press the Select soft key. • Press the dial pad key that corresponds to the item in the numbered menu list. For example, to select the second item in a menu, press 2.
Enter text	<p>In text-entry mode, press the number keys one or more times.</p> <p>For example, to enter "A," press  once. To enter "C," press  three times quickly.</p> <p>(To enter and dial an IP address or URL, see Placing Calls on page 3-2.)</p>

If you want to ...	Then do this ...
Enter numbers, uppercase characters, or lowercase characters	Press the 1/A/a soft key one or more times. The format the text will display in appears at the top of the screen.
Enter text in a specific language	Press the Encoding soft key. The language the text will display in appears at the top of the screen.
Enter special characters	Do the following: <ul style="list-style-type: none"> In text-entry mode, press the 1/A/a soft key to select A/Ascii or a/Ascii mode, and then press  or  one or more times. Press  one or more times.
Enter a space	In text-entry mode, press the 1/A/a soft key to select A/Ascii or a/Ascii mode, and then press  three times quickly.
Delete text you entered	Press the << soft key.
View additional soft keys	Press the More soft key.
Enable or disable fields	Press the Right or Left scroll key:  and  .

Customizing Your Phone

You can customize your SoundStation IP 7000 conference phone by adjusting certain settings, including time and date, language, display contrast and intensity, and ring tone. You can also add contacts to your phone's local Contact Directory.

This chapter shows you how to customize your phone. It includes the following topics:

- [Configuring Basic Settings](#) on page 2-1
- [Adjusting the Speaker and Ringer Volume](#) on page 2-14
- [Using Call Lists](#) on page 2-14
- [Managing Contacts](#) on page 2-17
- [Managing Incoming Calls](#) on page 2-28

Some customizations, including setting up shared lines and viewing a Corporate Directory, must be configured by your system administrator.

To learn about the phone's basic features, see Chapter 3, [Using the Basic Features of Your Phone](#). To read about the phone's advanced features, see Chapter 4, [Using the Advanced Features of Your Phone](#).

For more information or assistance with your new phone, see your system administrator.

Configuring Basic Settings

To configure basic phone settings, press , and then select **Settings > Basic** to view the basic phone settings you can customize.

This section includes the following topics:

- [Updating Preferences](#)
- [Updating the Display Contrast](#)
- [Updating the Backlight Intensity](#)
- [Updating the Ring Tone](#)
- [Updating Audio Quality and Capabilities](#)

Updating Preferences

The Preferences menu allows you to customize the language that displays on the phone and how the time and date display on the idle screen.

You can also enable your phone to save Corporate Directory search results (if Corporate Directory is set up on your phone). See [Searching for Contacts in a Corporate Directory](#) on page 2-24.

Updating the Language

The phone supports the following languages. English (Internal) is the default language that displays.

Language (Localization)
1. English (Internal)
2. Chinese (China)
3. Danish (Denmark)
4. Dutch (Netherlands)
5. English (Canada)
6. English (United Kingdom)
7. English (United States)
8. French (France)
9. German (Germany)
10. Italian (Italy)
11. Japanese (Japan)
12. Korean (Korea)
13. Norwegian (Norway)
14. Polish (Poland)
15. Portuguese (Portugal)
16. Russian (Russia)
17. Slovenian (Slovenia)
18. Spanish (Spain)
19. Swedish (Sweden)

To change the language:

1. Press , and then select **Settings > Basic > Preferences > Language**.

The Language screen displays.



2. Scroll to the language you want, and then press **Select**.

The text that appears on the screen will change to the language that you selected.

3. Press  to return to the idle screen.

Updating the Time and Date Display

The time and date display on the idle screen of your phone. If the phone cannot obtain a time and date, the display will flash. If this happens, or if the time or date is incorrect, see your system administrator.

You can select from various formats for the time and date display. Select and set options that are right for you. You can also disable the time and date display, so the time and date do not display on the phone screen.

The following figure shows the default format for the date and time display.



To display a new time format:

1. Press , and then select **Settings > Basic > Preferences > Time & Date > Clock Time**.

The Clock Time screen displays.

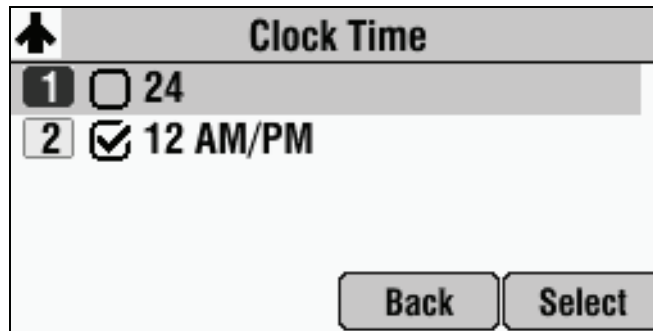



2. Scroll to the time format you want, and then press **Select**.
3. Press  to return to the idle screen.

To display a new date format:

1. Press , and then select **Settings > Basic > Preferences > Time & Date > Clock Date**.

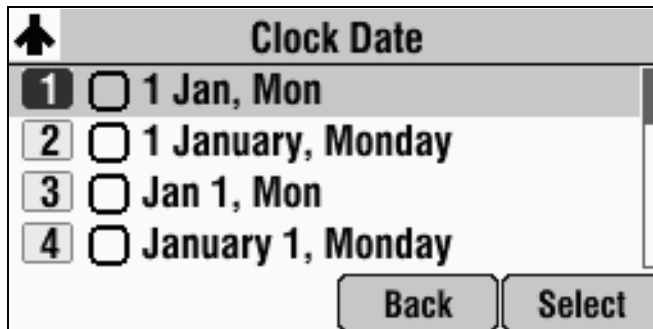
The Clock Date screen displays.



2. Scroll to the date format you want, and then press **Select**.
3. Press  to return to the idle screen.

To disable the time and date display:

1. Press , and then select **Settings > Basic > Preferences > Time & Date**.

The Time & Date screen displays.



2. Scroll to **Disable**, and then press **Select**.
3. Press  to return to the idle screen.

The idle screen no longer displays the time and date. To display the time and date again, enable the time and date (see below).

To enable the time and date display:

1. Press , and then select **Settings > Basic > Preferences > Time & Date**.

The Time & Date screen displays.

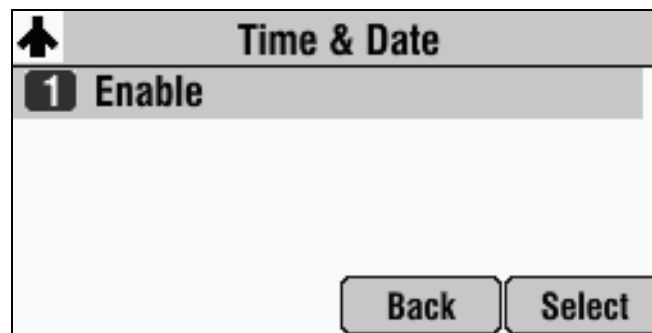

2. Press **Select**.
3. Press  to return to the idle screen.

The idle screen now displays the time and date.

Updating the Display Contrast

To adjust the contrast on the phone display:

1. Press , and then select **Settings > Basic > Contrast**.

The Contrast screen displays.

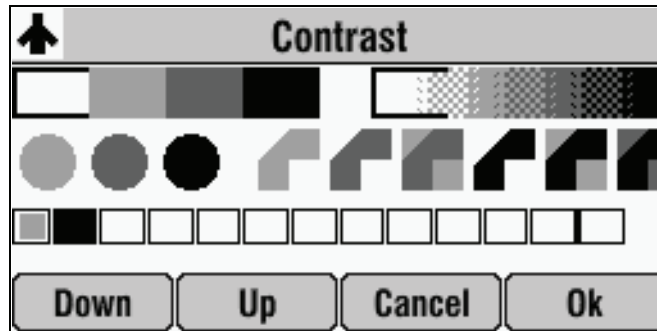

2. Press the **Up** or **Down** soft keys to increase or decrease the display contrast.
3. Press the **Ok** soft key.
4. Press  to return to the idle screen.

Updating the Backlight Intensity

Backlight intensity on the phone has three components:

- Backlight On
- Backlight Idle
- Maximum Intensity

You can modify the Backlight On intensity and the Backlight Idle intensity separately. You can select high, medium, low, and off levels for both.

When you modify the Maximum Intensity, you modify the entire backlight intensity scale. For example, if you decrease the Maximum Intensity, the low, medium, and high levels for both Backlight On and Backlight Idle intensities decrease.

The Backlight On intensity applies to following events:

- Any key press
- Incoming calls
- Ending a call, holding a call, or resuming a call by the other person
- A voice message received

If you do not press any keys on the phone, after 20 seconds of the backlight turning on, the backlight dims (or changes) to medium in the following cases:

- A call is in progress
- A call is on hold
- There is an incoming call (ringing)
- There is an outgoing call (ringing back)
- Any menu shows on the display

In all other cases, the Backlight Idle intensity applies.

To update the backlight intensity:

1. Press , and then select **Settings > Basic > Backlight Intensity**.

The Backlight Intensity screen displays.



2. Select **Backlight On Intensity**.

The Backlight On Intensity screen displays.



3. Scroll to the intensity you want, and then press **Select**. The default Backlight On Intensity is High.
4. Press the **Save** soft key.

5. Select **Backlight Idle Intensity**.

The Backlight Idle Intensity screen displays.



6. Scroll to the intensity you want, and then press **Select**. The default Backlight Idle Intensity is Low.
7. Press the **Save** soft key.
8. Select **Maximum Intensity**.

The Maximum Intensity screen displays.

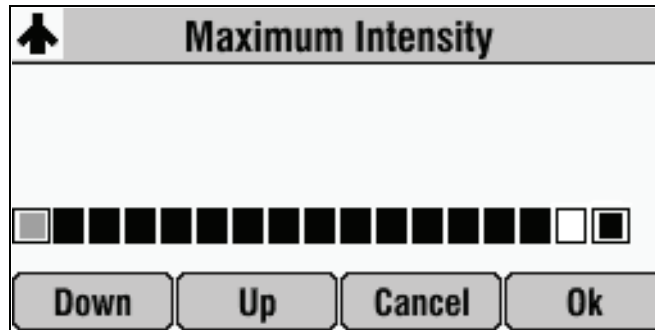

9. Press the **Up** or **Down** soft keys to increase or decrease the maximum intensity the screen can display, and then press the **Ok** soft key.
10. Press  to return to the idle screen.

Updating the Ring Tone

You can select from many different ring tones to distinguish your phone from your neighbor's. You can also set distinctive ring tones for contacts in your local directory so you can identify callers when your phone rings.

Selecting a Different Ring Tone for Your Phone

You can choose a unique ring tone for your phone to identify it when it rings.

To select a ring tone for your phone:

1. Press , and then select **Settings > Basic > Ring Type**.

The Ring Type screen displays.



2. Scroll to the ring type you want. To hear the ring type, press the **Play** soft key. The default ring type is Low Trill.
3. Press **Select**.
4. Press  to return to the idle screen.

Setting Distinctive Ring Tones for Contacts

Note

Your company's settings may override this feature. For more information, contact your system administrator.

You can set a distinctive ring tone for each contact in your contact directory so you can distinguish callers.

To set a distinctive ring tone for a contact:

1. Press , and then select **Features > Contact Directory**.

The Directory screen displays.

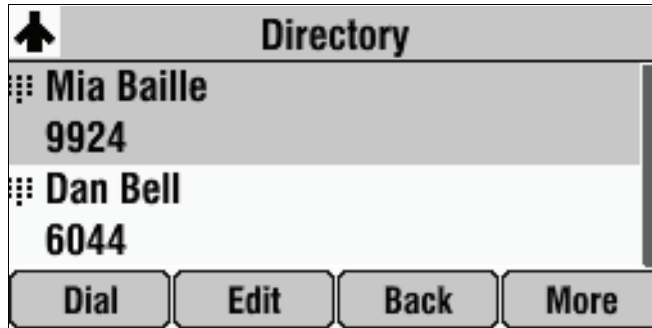

2. Scroll to the contact for whom you want to assign a distinctive ring tone.
3. Press the **Edit** soft key.

The Edit Contact screen displays.

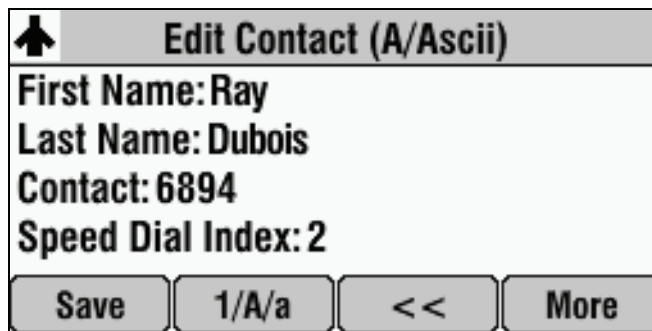

4. Scroll to **Ring Type**, and then enter a number corresponding to one of the ring types available.

If a ring type is already assigned to the contact, but you want to change it, press the << soft key to delete the existing ring type. Then, enter a number corresponding to one of the ring types available.

Note

To exit this screen and determine the number associated with a ring type, press the **Menu** key, and then select **Settings > Basic > Ring Type**. Each ring type has a number associated with it.

5. Press the **Save** soft key.
6. Press  to return to the idle screen.

Updating Audio Quality and Capabilities

You can adjust the audio quality of your phone, and enable auxiliary audio components, such as wireless (lapel) microphones, speakers, recording devices, and computers that you connect to the Multi-Interface Module.

Updating the Sound Quality of Your Phone

You can adjust the sound quality of your phone by changing the treble or bass control.

To adjust the sound quality of your phone:

1. Press , and then select **Settings > Basic > Audio > Bass and Treble**.

The Bass and Treble screen displays.

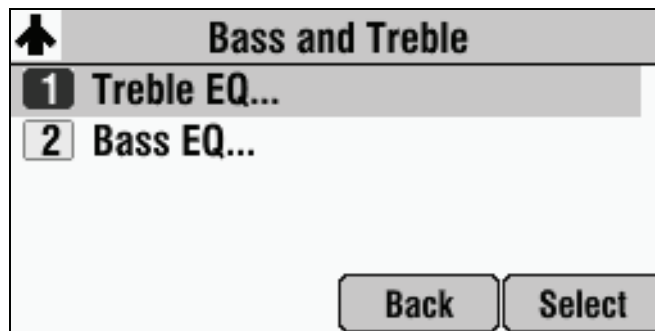

2. Do one of the following:
 - To adjust the treble control, scroll to **Treble EQ**, and then press **Select**.

The Treble EQ screen displays.

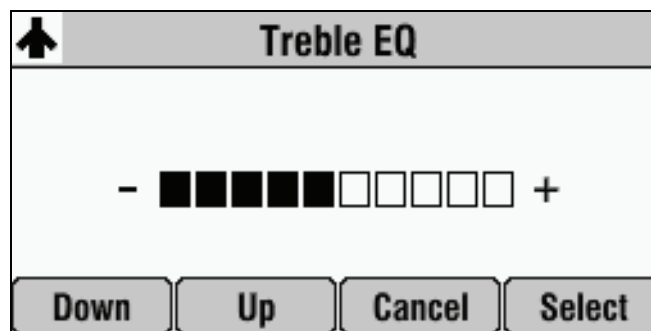

or

- To adjust the bass control, scroll to **Bass EQ**, and then press **Select**. The Bass EQ screen displays.

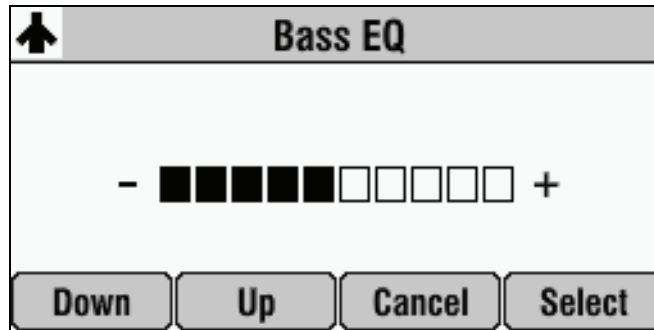

3. Press the **Up** or **Down** soft keys to adjust the treble or bass EQ, and then press **Select**.
4. Press  to return to the idle screen.

Enabling Auxiliary Audio Components

Before you can use the auxiliary audio components that you connect to the Multi-Interface Module (wireless microphones, speakers, as well as recording devices and computers to record phone calls), you must enable them. You enable the components from the Auxiliary Audio menu.

Note

You do not have to enable audio from a mobile phone or from a computer calling application. This audio is automatically enabled when you connect the Mobile Phone Cable or the Computer Calling Cable to the 2.5mm audio connector on your conference phone.

For information on connecting auxiliary audio components to the conference phone or Multi-Interface Module, see [Connecting Optional Auxiliary Audio Components](#) on page 1-9.

To enable or disable wireless (lapel) microphones:

1. Press , and then select **Settings > Basic > Audio > Auxiliary Audio > Aux Audio In**.

The Aux Audio In screen displays.

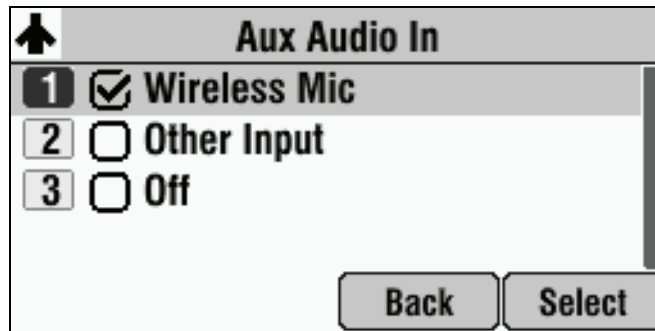



2. Do one of the following:
 - To enable a wireless (lapel) microphone, scroll to **Wireless Mic**, and then press **Select**.
 - To disable wireless microphones, scroll to **Off**, and then press **Select**.
3. Press  to return to the idle screen.

To enable or disable speakers, as well as recording devices and computers:

1. Press , and then select **Settings > Basic > Audio > Auxiliary Audio > Aux Audio Out**.

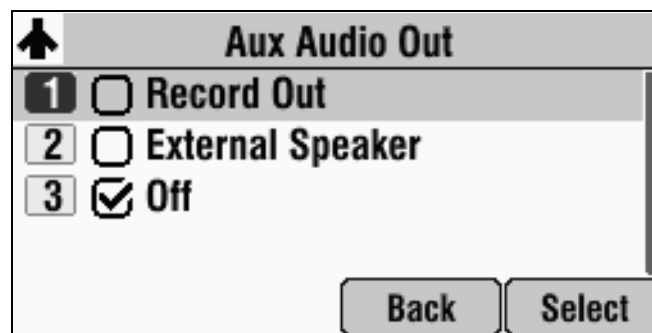

The Aux Audio Out screen displays.





2. Do one of the following:
 - To enable recording devices or computers to record phone calls, scroll to **Record Out**, and then press **Select**.
 - To enable external speakers, scroll to **External Speaker**, and then press **Select**.
 - To disable speakers, and to prevent recording devices and computers from recording phone calls, scroll to **Off**, and then press **Select**.
3. Press  to return to the idle screen.

Adjusting the Speaker and Ringer Volume

To adjust the speaker volume:

>> During a call, press either  or  to adjust the speaker volume.

To adjust the ringer volume:

>> When the phone is in the idle state, press either  or  to adjust the ringer volume.

Using Call Lists

Your phone maintains lists of missed, received, and placed calls. Each list can hold up to 100 entries.

If you miss a call (for example, if you do not answer a call, or you have call forwarding or Do Not Disturb enabled), the idle screen will display a message indicating the number of missed calls you have. To view information about the missed call, view your Missed Calls list (see [Viewing Call Lists](#), below). After you view the Missed Calls list, the message on the idle screen is removed.

The following figure shows what the idle screen looks like when you miss a call.



Viewing Call Lists

You can access missed, received, and placed calls from the idle screen, or you can quickly access call lists using the scroll keys.

To view a call list:

>> From the idle screen, do one of the following:

- Press , and then select **Features > Call Lists > Missed Calls, Received Calls, or Placed Calls.**

or

- Press the **Dir** soft key, and then select **Call Lists > Missed Calls, Received Calls, or Placed Calls.**

or

- Use the scroll keys to access a call list:
 - To view the Received Calls List, press the **Left** scroll key.
 - To view the Placed Calls List, press the **Right** scroll key.
 - To view the Missed Calls List, press the **Down** scroll key.

Managing Call Lists

You can clear all the records in a call list, or just one record. You can also choose a record in a list and return the call, store the call details in your local Contact Directory, or view detailed information about the particular call.

To manage a call list:

1. Press the **Dir** soft key, and then select **Call Lists**.

The Call Lists screen displays.



2. Do one of the following:

- To clear the records in a call list, select **Clear > Missed Calls, Received Calls, or Placed Calls**.

The following figure shows the message that displays when you clear a Missed Calls list.

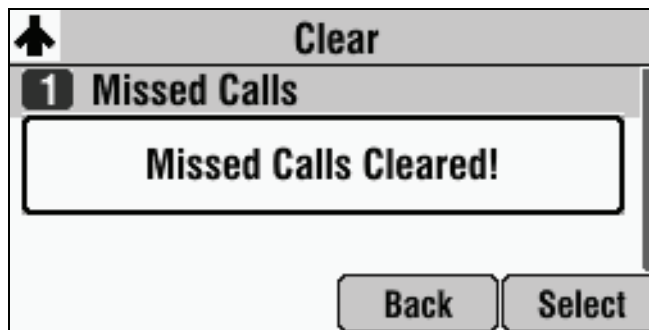

Note

To manually clear all calls in all call lists, restart the phone. See [Restarting the Phone](#) on page 4-26.

- To view and manage a call list, scroll to either **Missed Calls**, **Received Calls** or **Placed Calls**, and then press **Select**. Your call list information displays.

The following figure shows a Placed Calls list.

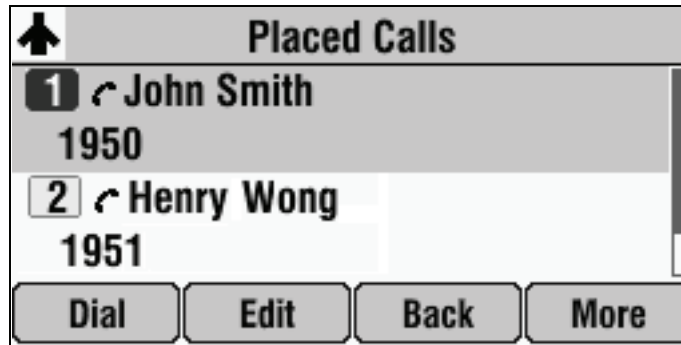

To manage your call list:

- To return the call, press the **Dial** soft key.
 - To edit the phone number (if necessary) before you place the call or store the call details in your Contact Directory, press the **Edit** soft key.
 - To return to the Call Lists menu, press the **Back** soft key.
 - To remove the call from the list, press the **Clear** soft key.
 - To store the contact in your Contact Directory, press the **Save** soft key.
 - To view information about the call, such as the phone number, the time and duration of the call, and the name of the caller, press the **Info** soft key.
3. Press  twice to return to the idle screen.

Managing Contacts

You can store a large number of contacts in your phone's local Contact Directory. Contact your system administrator for the exact number.

You can dial and search for contacts in this directory. You may be able to add, edit, and delete contacts. Contact your system administrator to see if you have read-only access to your local Contact Directory, or if you can update it.

If your system administrator sets up a Corporate Directory on your phone, you may also have read access to portions of your Corporate Directory. Your system administrator determines which contacts you can see. You can search for contacts in the Corporate Directory, and add contacts from the Corporate Directory to your local Contact Directory. For more information, see [Searching for Contacts in a Corporate Directory](#) on page 2-24 and [Adding Contacts to Your Local Contact Directory From a Corporate Directory](#) on page 2-22.

To view your local Contact Directory:

>> Do one of the following:

- Press , and then select **Features > Contact Directory**.

or

- Press the **Dir** soft key, and then select **Contact Directory**.

The Directory screen displays, listing all the contacts in your directory.

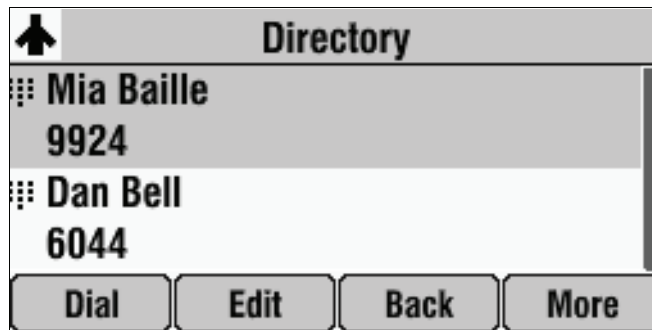

To view your Corporate Directory:

>> Do one of the following:

- Press , and then select **Features > Corporate Directory**.

or

- Press the **Dir** soft key, and then select **Corporate Directory**.

The Corporate Directory screen displays, listing all the contacts in your directory. You can search for and dial contacts, or save contacts to the local Contact Directory.



Adding Contacts to Your Local Contact Directory

You can add contacts to your local Contact Directory in the following ways:

- Manually (if you have permission to update your local Contact Directory)
- From a call list
- From a Corporate Directory (if this is set up on your phone)

Note

You cannot update Corporate Directory from your phone.

Adding Contacts Manually

You can update your local Contact Directory manually, instead of importing contact information from a call list or a Corporate Directory.

To add a contact manually:

1. Press the **Dir** soft key, and then select **Contact Directory**.

The Directory screen displays.

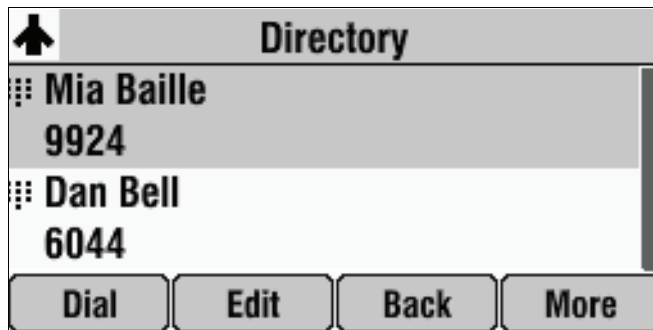

2. To add a contact to your phone's database, press the **Add** soft key.

The Add To Directory screen displays.

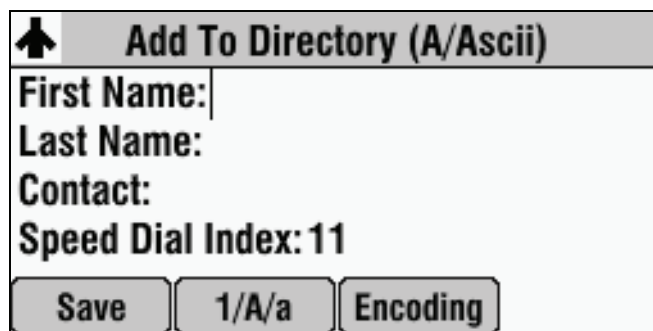

3. Enter the contact information. To move between fields, use the **Up** and **Down** scroll keys. Enter the following information:

Note

Your phone may not display all the following fields. For more information, see your system administrator.

- (Optional.) Enter the First Name and Last Name of the contact.
You can enter a maximum of 32 characters. To alternate between numeric, uppercase, and lowercase alphanumeric modes, press the **1/A/a** soft key. To enter text in another language, press the **Encoding** soft key.
- (Required.) Enter the Contact phone number.
You can enter a maximum of 32 characters. The contact number must be unique, and must not already exist in the directory. If you try to save an entry with a non-unique phone number, or you do not enter a phone number, an error message displays.
- (Optional.) Change the Speed Dial Index number.
The speed dial index is automatically assigned to the next available index value, up to a maximum value of 99.
You can assign any unused speed dial index number from 1 to 99. If you assign a speed dial index number that is already taken, or you enter an invalid speed dial index number (for example, 0 or 00), an error message displays.
For more information on speed dial index numbers, see [Managing Speed Dial Entries](#) on page 3-23.
- (Optional.) Enter a Label for the contact. You can enter a maximum of 32 symbols, letters, or numbers.
If you specify a label, the label will be the first item that displays for the contact in the Contact Directory and on the Speed Dial Info screen (before the contact's first and last names, if specified). For example, in the following figure, the labels Sales and Marketing have been assigned to contacts in the local Contact Directory.

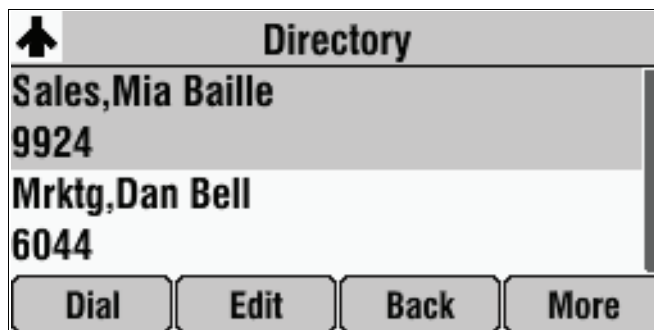

- (Optional.) Set the Ring Type.

For information on setting the ring type, see [Updating the Ring Tone](#) on page 2-8.

- (Optional.) Assign a Divert Contact.

The Divert Contact identifies the third person to which you want this contact's calls sent. You can enter a maximum of 32 characters.

- (Optional.) Change the Auto Reject and Auto Divert settings.

If you set the Auto Reject field to enabled, each time the contact calls, the call will be directed to your voice mail system (if a voice mail system is set up). If you set the Auto Divert field to enabled, each time the contact calls, the call will be directed to a third person you specify in the Divert Contact field.

Press the **Right** or **Left** scroll key to switch between the Enabled and Disabled settings for the Auto Reject and Auto Divert fields.

Note

If you do not have a voice mail system set up, enabling the Auto Reject field will have no effect. Each time the contact calls, your phone will ring (unless you choose to divert the contact's calls, or enable call forwarding or Do Not Disturb).

- (Optional.) Change the Watch Buddy and Block Buddy settings.

If you set the Watch Buddy field to enabled, you can monitor the contact's status. If you set the Block Buddy field to enabled, the contact cannot monitor your status. For more information on monitoring status, see [Using Buddy Lists](#) on page 4-20.

Press the **Right** or **Left** scroll key to switch between the Enabled and Disabled settings for the Watch Buddy and Block Buddy fields.

4. Press the **Save** soft key.
5. Press  twice to return to the idle screen.

Adding Contacts From Call Lists

You can save call information from a call list to your local Contact Directory.

To add a contact to the local Contact Directory from a call list:

1. Press the **Dir** soft key, and then select **Call Lists > Missed Calls, Received Calls, or Placed Calls**.
2. Scroll to the contact.
You can use the * key to Page Up and the # key to Page Down.
3. To save the contact to your Contact Directory, press the **Save** soft key.
4. Press  twice to return to the idle screen.

Note

You may want to go to the Contact Directory and check if the contact was saved correctly and to add any missing fields. To view your Contact Directory, see [Managing Contacts](#) on page 2-17. To update missing contact information, see [Adding Contacts Manually](#) on page 2-19 (step 3).

Adding Contacts to Your Local Contact Directory From a Corporate Directory

You can save any contact listed in your Corporate Directory (if it is set up on your phone) to your local Contact Directory.

To add a contact to your local Contact Directory from a Corporate Directory:

1. Press the **Dir** soft key, and then select **Corporate Directory**.

The Corporate Directory screen displays.



2. Search for the contact, and then scroll to the contact's entry.

For information on how to search for a contact, see [Searching for Contacts in a Corporate Directory](#) on page 2-24.

3. Press the **View** soft key.

The Contact screen displays.



4. To save the contact to the local Contact Directory, press the **Save** soft key.
“Saved” displays on the screen. Only the first name, last name, and phone number are saved.

If the contact already exists in your local Contact Directory, “Contact already exists” displays.
5. Press  twice to return to the idle screen.

Note

You may want to go to the Contact Directory and check if the contact was saved correctly and to add any missing fields. To view your Contact Directory, see [Managing Contacts](#) on page 2-17. To update missing contact information, see [Adding Contacts Manually](#) on page 2-19 (step 3).

Searching for Contacts

You can search for contacts in your local Contact Directory, or in a Corporate Directory (if this is set up on your phone).

Searching for Contacts in Your Local Contact Directory

Search for a contact by scrolling through the directory, or entering specific search criteria.

To search for a contact in the local Contact Directory:

1. Press the **Dir** soft key, and then select **Contact Directory**.

The Directory screen displays.

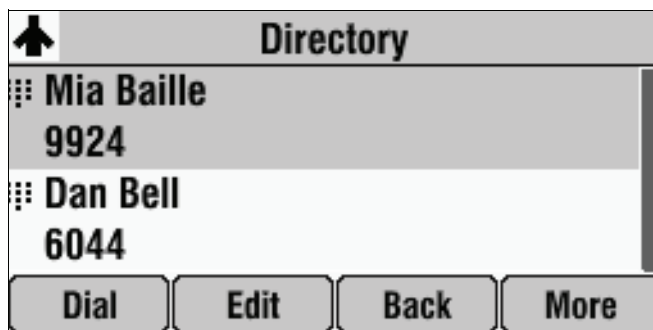

2. Press the **Search** soft key. Then, enter the first few characters of the contact's first or last name, and then press the **Search** soft key again.

The Directory Search screen displays a list of successful matches.

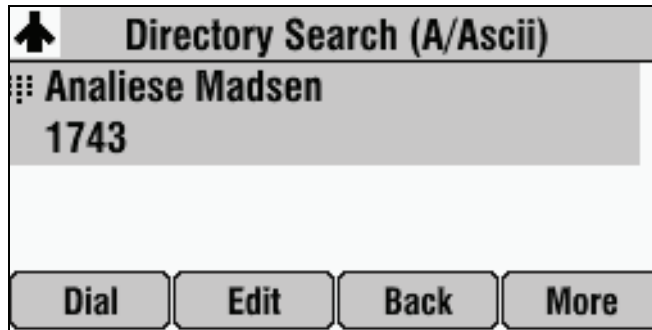

3. Scroll to the contact you are searching for.
From this screen, you can dial, edit, or delete the contact.
4. Press  twice to return to the idle screen.

Searching for Contacts in a Corporate Directory

Search for a contact by scrolling through the directory, or entering specific search criteria.

Note

You can enable your phone to save Corporate Directory search results, and to remember the last person you viewed in the directory. Whenever you re-display Corporate Directory, the last person you viewed will display. If you searched for a person, the results of the last search you submitted will display. To enable this feature, press the **Menu** key, and then select **Settings > Basic > Preferences > Corporate Directory > Retain Search**. Scroll to **Enabled**, and then press **Select**.

To search for a contact in the Corporate Directory:

1. Press the **Dir** soft key, and then select **Corporate Directory**.

The Corporate Directory screen displays.



2. Press the **Search** soft key. Then, enter the first few characters or numbers of a search criteria, and then press the **Submit** soft key.

The screen displays a list of successful matches.

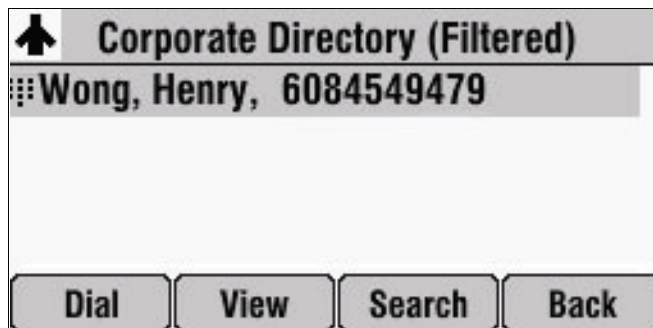

3. Scroll to the contact you are searching for.

From this screen, you can press the **Dial** soft key to dial the contact, or press the **View** soft key and save the contact to your local Contact Directory.

4. Press  twice to return to the idle screen.

Updating Contacts in Your Local Contact Directory

You can update information for contacts in your local Contact Directory. You cannot update information for contacts in your Corporate Directory.

To update a contact in your local Contact Directory:

1. Press the **Dir** soft key, and then select **Contact Directory**.

The Directory screen displays.



2. Scroll to the contact whose information you want to update, or search for the contact (see [Searching for Contacts in Your Local Contact Directory](#) on page 2-23).
3. Press the **Edit** soft key.

The Edit Contact screen displays.

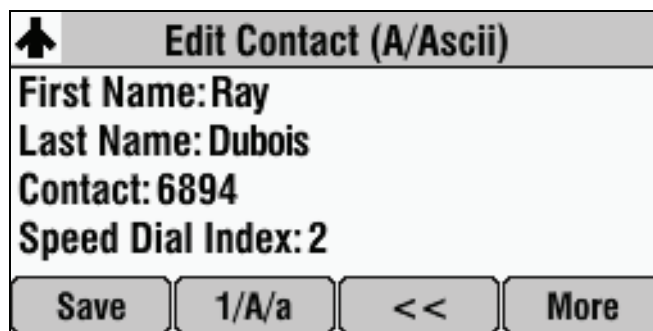

4. Update the contact information. For information on the fields you can update, see [Adding Contacts Manually](#) on page 2-19 (step 3).
5. Press the **Save** soft key.
6. Press  twice to return to the idle screen.

Deleting Contacts From Your Local Contact Directory

You can delete contacts from your local Contact Directory. You cannot delete contacts from your Corporate Directory.

To delete a contact from the local Contact Directory:

1. Press the **Dir** soft key, and then select **Contact Directory**.

The Directory screen displays.

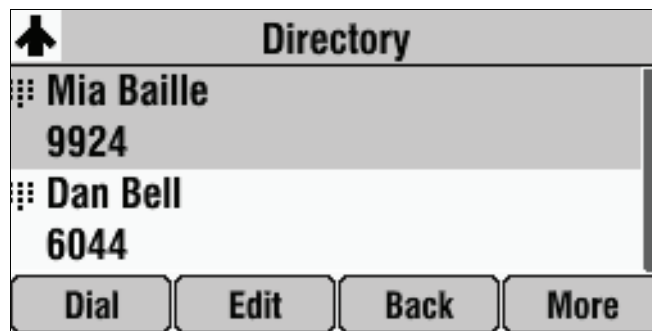

2. Scroll to the contact you want to delete. Or, search for the contact (see [Searching for Contacts in Your Local Contact Directory](#) on page 2-23).
3. Press the **Delete** soft key.
The contact is deleted from the directory.
4. Press  twice to return to the idle screen.

Placing Calls to Contacts

You can place calls to contacts from your local Contact Directory or from your Corporate Directory (if this is set up on your phone).

To place a call to a contact from your Local or Corporate Directory:

1. Press the **Dir** soft key, and then select **Contact Directory** or **Corporate Directory**.
2. From the Directory or Corporate Directory screen, scroll to the contact you want to call, or search for the contact (see [Searching for Contacts](#) on page 2-23).
3. Press the **Dial** soft key.

Managing Incoming Calls

You can manage incoming calls from the contacts in your local Contact Directory by doing the following:

- Setting up a distinctive ring tone for a contact
- Rejecting calls from a particular contact by sending the call to your voice mail system
- Diverting calls from a particular contact to another person

Distinguishing Calls

You can customize your phone so that you can distinguish callers by certain ring types. For information on setting a distinctive ring type for a particular contact, see [Setting Distinctive Ring Tones for Contacts](#) on page 2-9.

Rejecting Calls

You can customize your phone so that incoming calls from a particular person are immediately sent to your voice mail system. (If you do not have a voice mail system set up, the call will still ring on your phone.)

Note

Rejecting calls is not available on shared lines.

To send incoming calls from a particular contact directly to voice mail:

1. Press the **Dir** soft key, and then select **Contact Directory**.

The Directory screen displays.



2. Scroll to the contact whose calls you want to go to your voice mail system. You can use the * key to Page Up and the # key to Page Down.

3. Press the **Edit** soft key.

The Edit Contact screen displays.

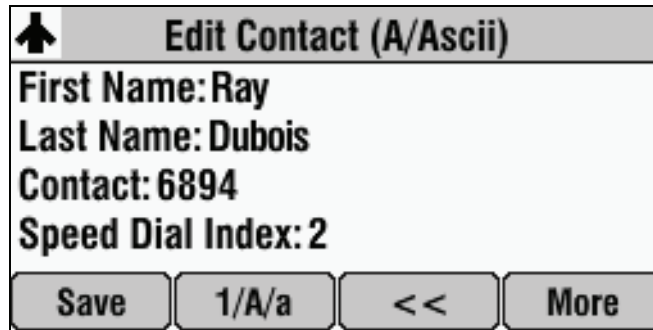

4. Scroll to the **Auto Reject** field and change the Auto Reject setting to **Enabled**. (To select Enabled, press the **Right** or **Left** scroll key.)
5. Press the **Save** soft key.
6. Press  twice to return to the idle screen.

Diverting Calls

You can customize your phone so that incoming calls from a particular person are transferred directly to a third person.

To divert incoming calls from a contact to a third person:

1. Press the **Dir** soft key, and then select **Contact Directory**.

The Directory screen displays.

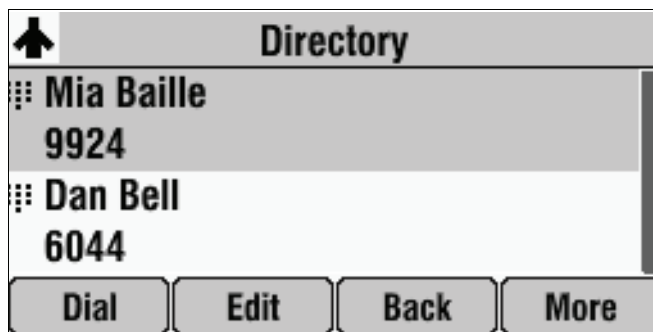

2. Scroll to the contact for whom you want to transfer calls.
You can use the * key to Page Up and the # key to Page Down.

3. Press the **Edit** soft key.

The Edit Contact screen displays.

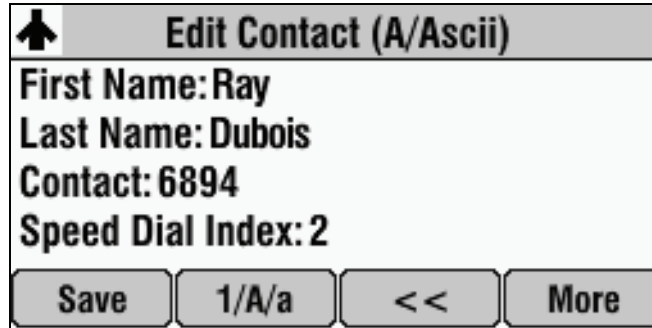

4. Scroll to the **Divert Contact** field and enter the number of the person to whom you want to divert the call. You can enter a maximum of 32 characters.
5. Scroll to the **Auto Divert** field.
6. Change the Auto Divert setting to **Enabled**. (To select Enabled, press the **Right** or **Left** scroll key.)
7. Press the **Save** soft key.
8. Press  twice to return to the idle screen.

Understanding Shared Lines

Note

Shared lines is an optional feature that your system administrator sets up. Your system may not support it. For more information, contact your system administrator.

If two phones share a line, an incoming call to one number will cause both phones to ring. The call can be answered by either phone, but not both. If your phone shares a line, a shared line icon that is half black and half grey displays on the screen.

The following figure shows the shared line icon at the top left of the screen.



The shared line icon changes to a moving icon, and the LEDs glow a steady red when the line is in use remotely.

Calls on shared lines can be transferred, put on hold, or added to a conference.

Note

You cannot forward or reject calls on shared lines.

For information on answering calls with shared lines, see [Answering Calls](#) on page 3-6.

Using the Basic Features of Your Phone

Your SoundStation IP 7000 conference phone is designed to be used like a regular conference phone on a public switched telephone network (PSTN). You can place calls, transfer a call to someone else, conduct a multi-participant conference call, or perform other basic and more advanced functions.

At any time, at most one active call may be in progress on your phone. The active call is the one that has audio associated with it. There may be multiple other calls, including a conference call, on hold.

This chapter provides introductory information and basic operating instructions for the phone. It includes the following topics:

- [Placing Calls](#) on page 3-2
- [Answering Calls](#) on page 3-6
- [Ending Calls](#) on page 3-6
- [Muting the Microphone](#) on page 3-7
- [Redialing Numbers](#) on page 3-7
- [Holding and Resuming Calls](#) on page 3-8
- [Hosting Conference Calls](#) on page 3-9
- [Transferring Calls](#) on page 3-16
- [Forwarding Calls](#) on page 3-19
- [Enabling Do Not Disturb](#) on page 3-21
- [Managing Speed Dial Entries](#) on page 3-23
- [Using Voice Mail](#) on page 3-24

If you require additional information or assistance with your new phone, contact your system administrator.

For information on the advanced features of your phone, refer to [Chapter 4, Using the Advanced Features of Your Phone](#).

Placing Calls

Note

If your phone is connected to a Polycom HDX system, see [Using the Phone When it is Connected to a Polycom HDX System](#) on page 4-7. When you place a call, different soft keys display and options apply.

You can place a call off-hook (with a dial tone) or on-hook (without a dial tone). If you place a call off-hook, you can dial a contact using an IP address or URL, if this feature is enabled for your phone.

The phone screen displays the duration of active calls. The following figure shows an active call to Jacklyn Smith at directory number 1955 that has lasted 57 seconds.

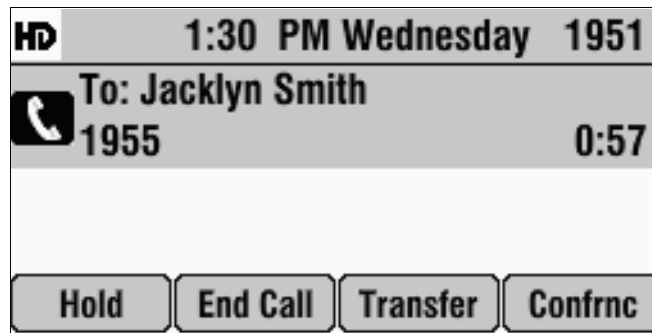

To place a call on-hook (to dial a phone number):

>> Enter the phone number of the person you want to call, and then press

 or the **Dial** soft key.

To place a call off-hook (to dial a phone number, IP address, or URL):**Note**

Placing a call using an IP address or URL may not be enabled for your phone. For more information, see your system administrator.

1. Press  or the **New Call** soft key.

The Enter number screen displays.

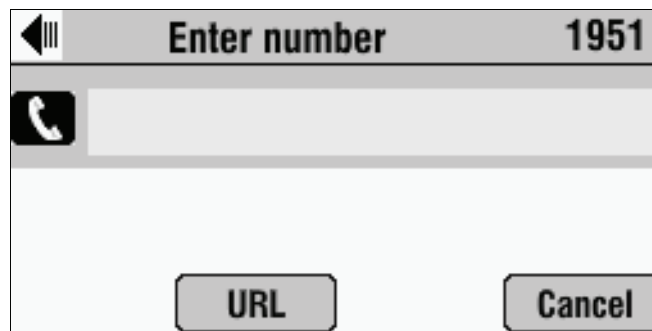

2. Do one of the following:
 - To dial a phone number, enter the phone number of the person you want to call.
 - To dial an IP address:
 - a Press the **URL** soft key.

The (123) Enter number screen displays.

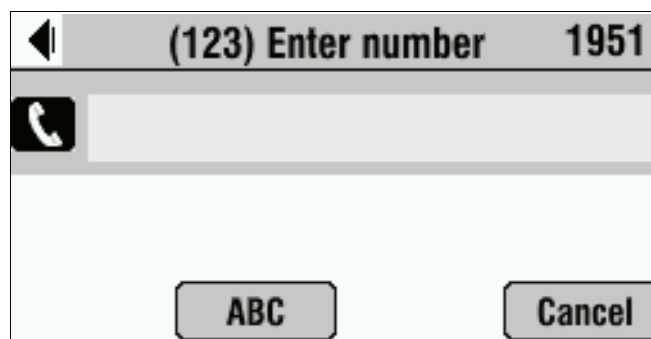

- b Enter the IP address of the person you want to call.

To enter ".", press .

- To dial a **URL**:

- a Press the **URL** soft key.

The (123) Enter number screen displays.

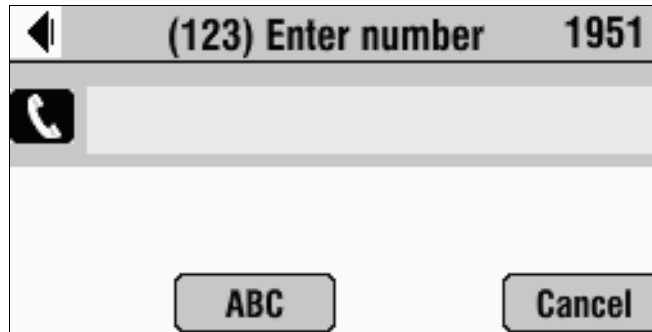

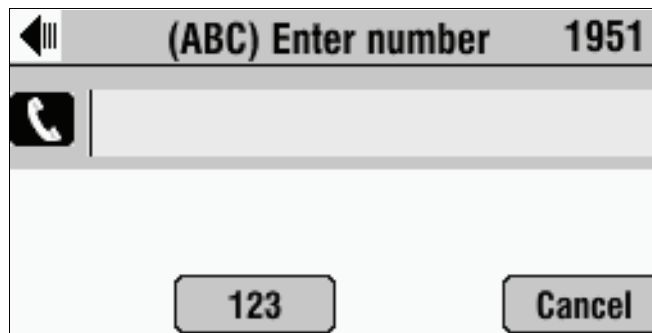

- b Press the **ABC** soft key.

The (ABC) Enter number screen displays



- c Enter the URL of the person you want to call.

To enter the letters that display on a number key, press the number key one or more times.

For example, to enter "a," press  once. To enter "c," press  three times quickly.

To enter "." and "@", press  one or more times quickly.

Note

When you dial a URL, the maximum number of characters you can enter is 32.

- 3. Press  or the **Dial** soft key.

Note

Instead of entering a phone number from memory, you can access call lists, directories, and speed dial lists to display and dial the number for you.

- To access a call list, press the **Left**, **Right**, or **Down** scroll key to access the received, placed, or missed calls list. Scroll to the call you want to dial, and then press the **Dial** soft key. For more information, see [Using Call Lists](#) on page 2-14.
- To access your Contact Directory or Corporate Directory (if enabled for your phone), press the **Dir** soft key, and then select **Contact Directory** or **Corporate Directory**. Scroll to or search for the contact you want to dial, and then press the **Dial** soft key. For more information, see [Managing Contacts](#) on page 2-17.
- To place a call using a speed dial index number, press the **Up** scroll key, scroll to the person you want to call, and then press the **Dial** soft key. For information on other ways to use speed dial, see [Placing Calls Using Speed Dial](#), below.

Placing Calls Using Speed Dial

Use a speed dial index number for quick dialing. Speed dial index numbers are associated with entries in your Contact Directory. For information on managing speed dial entries from your Contact Directory, see [Managing Speed Dial Entries](#) on page 3-23.

Note

From the idle screen, press the **Up** scroll key to quickly access your list of speed dial entries.

To place a call using a speed dial index number:

1. Do one of the following:
 - If you know the contact's speed dial index number, enter the number, and then press #.
 - Press the **Up** scroll key.
 - Press , and then select **Features > Speed Dial**.

The Speed Dial Info screen displays.

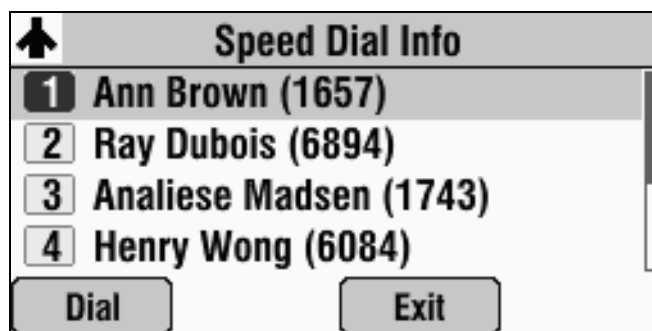

2. Do one of the following:
 - Enter the speed dial index number.or
 - If the contact you want to call is not already highlighted, scroll to the contact, and then press the **Dial** soft key.The call is placed.

Answering Calls

To answer a call:

>> Press  or the **Answer** soft key.

The LEDs blink green when the phone rings.

Note

- To ignore incoming calls, press the **Reject** soft key (for private lines) or the **Silence** soft key (for shared lines). To prevent your phone from ringing, enable the **Do Not Disturb** feature (see [Enabling Do Not Disturb](#) on page 3-21).
- You can forward incoming calls by pressing the **Forward** soft key. See [Forwarding Calls Dynamically](#) on page 3-21.
- If you set up your phone with a silent ring, press the **Answer** soft key to answer the call.
- To answer a call from a mobile phone or computer calling application, see [Using Computer or Mobile Audio with the Conference Phone](#) on page 4-1.

To answer a call on a shared line:

1. Answer the incoming call.
2. Press the **Hold** soft key.

Anyone on another phone configured to use the same shared line may take the call by selecting the call on their phone screen.

Ending Calls

To end a call:

>> Press  or the **End Call** soft key.

Note

You cannot end a call that is on hold until you resume the call. To end a call on hold, scroll to the call on hold, press the **Resume** soft key, and then press the **End Call** soft key.

Muting the Microphone

To mute the microphone:

>> During a call, press .



The LEDs glow red, and the mute icon, , displays on the phone screen.

The other person (or people) cannot hear you. You can still hear all other people while Mute is enabled.

To turn off the Mute feature, press  again.

To mute the microphone if you use extension microphones:

>> Press  on the phone or the  button on the top of the extension microphones.

To turn off the Mute feature, press  or  again.

Note

When you press the Mute button on the phone, or on any extended microphone connected to the phone, you mute the microphone on the phone and all extended microphones connected to the phone.

Redialing Numbers

You can redial the last number you dialed, or search a list of placed calls to find a previously-dialed number.

To redial the last number dialed:

>> Press .

To redial a previously dialed number:

1. Press the **Dir** soft key, and then select **Call Lists > Placed Calls**.

The Placed Calls screen displays.

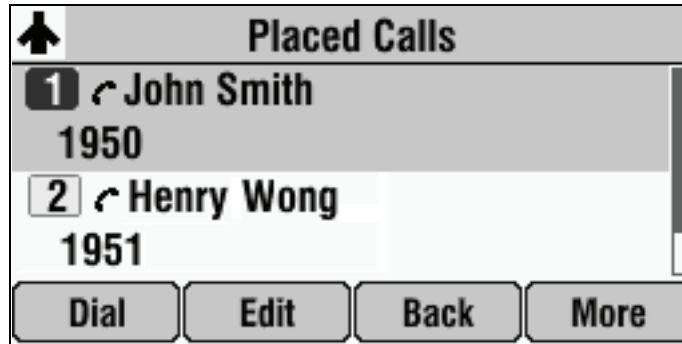

2. Scroll to the number you want to redial, and then press  or the **Dial** soft key.

Holding and Resuming Calls

To hold a call:

- >> During a call, press the **Hold** soft key. The LEDs blink red to indicate that a call is on hold.

Note

You cannot end a call that is on hold. You must resume the call first.

The following figure shows James Smith on hold. The Resume soft key now displays on the screen.

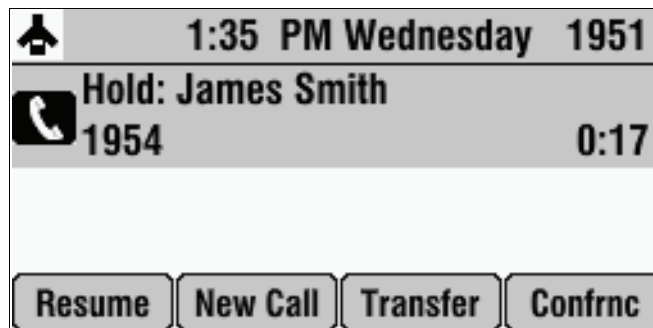

To resume a call on hold:

- >> While a call is on hold, press the **Resume** soft key.

Hosting Conference Calls

You can create a conference with up to two other people using the phone's local conference feature. To quickly set up a conference, you can use the Join soft key to create a conference between an active call and a call on hold.

The conference management feature allows you to view and manage each participant in the conference call. From the Manage Conference screen, you can mute, hold, and remove individual participants.

Note

You can host and manage conferences with audio from computer calling applications and mobile phones, as well as video if your phone is connected to a Polycom HDX system. For more information, see [Using Computer or Mobile Audio with the Conference Phone](#) on page 4-1 and [Using the Phone When it is Connected to a Polycom HDX System](#) on page 4-7.

This section includes the following topics:

- [Setting Up Conferences](#) on page 3-9
- [Managing Conferences](#) on page 3-11
- [Holding and Resuming Conferences](#) on page 3-15
- [Splitting Conferences](#) on page 3-16
- [Ending Conferences](#) on page 3-16

Setting Up Conferences

You can set up a conference in one of two ways:

- Using  or the **Confrnc** soft key.
- Using the **Join** soft key, if you have an active call and a call on hold.

Setting Up a Conference Using the Conference Key or Soft Key

To set up a conference using the Conference key or soft key:

1. Call the first person. See [Placing Calls](#) on page 3-2.
2. Press  or the **Confnc** soft key to create a new call. The active call is placed on hold.

The Enter number screen displays.

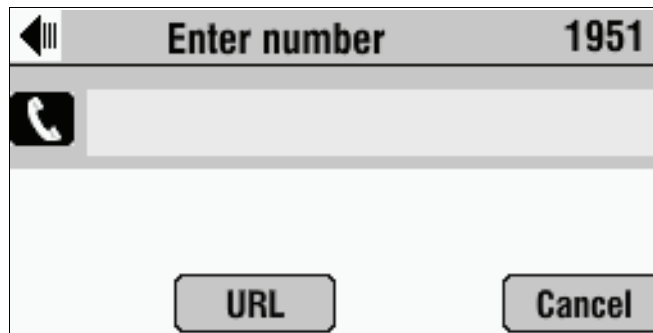

Note

If configured for single key-press conferences, the conference participant hears the dial tone and ringback when the conference host places the call to the new person.

3. Place a call to the second person. See [Placing Calls](#) on page 3-2.
4. When the second person answers, press  or the **Confnc** soft key again to join all people in the conference.

Note

If configured for single key-press conferences, you do not have to press the Conference key or the **Confnc** soft key again.

The Active:Conference screen displays.

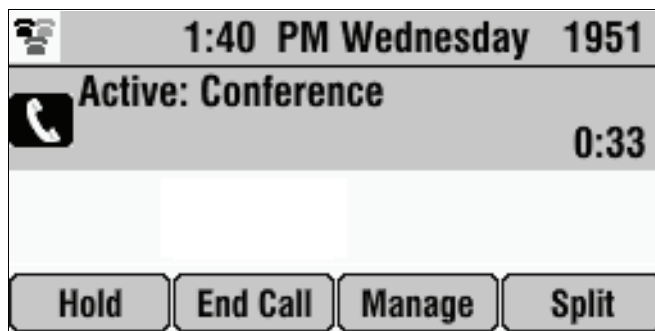

Setting Up a Conference With an Active Call and a Call on Hold

If you are currently in an active call, and you have another call on hold, you can create a conference call between the active call, the call on hold, and yourself, by pressing the **Join** soft key.

To set up a conference call with an active call and a call on hold:

>> If you have an active call and a call on hold, press the **Join** soft key.

The Active:Conference screen displays.

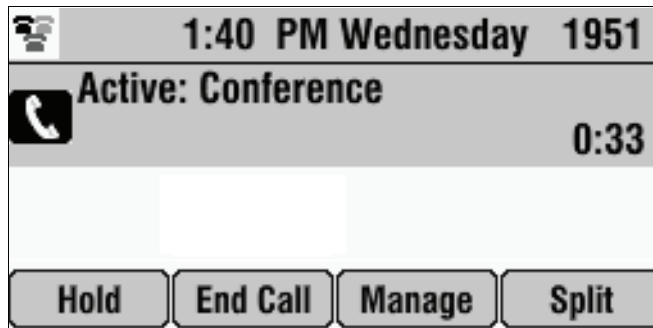

A conference is created with the active call, the call on hold, and yourself.

Managing Conferences

To manage a conference, you must currently be in an active conference call. From the Active:Conference screen, you can press the **Manage** soft key to manage the individual participants in the conference, or end the conference call.

The following figure shows the Manage soft key that displays when you are in an active conference.

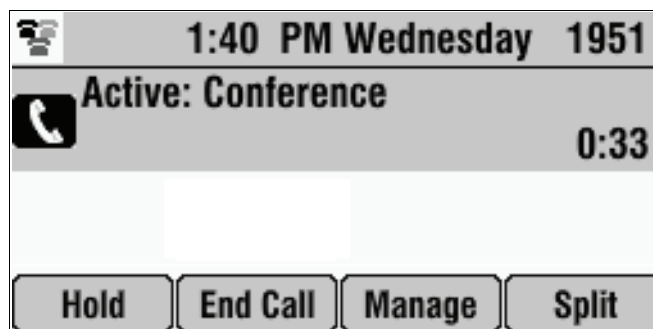

To manage a conference:

>> From the Active:Conference screen, press the **Manage** soft key.

The Manage Conference screen displays.

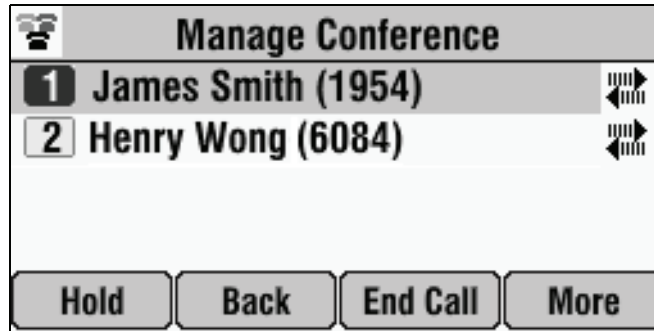

From the Manage Conference screen, you can scroll to a conference participant and manage the participant's conference participation, or end the conference call.

You can access the following soft keys from the Manage Conference screen:

- **Hold** – Puts a selected participant on hold. The held participant cannot hear any other participants and no participant can hear the held participant.
- **Back** – Returns you to the Active:Conference screen.
- **End Call** – Ends the conference call. The other two participants remain connected. (To remove a conference call participant, see [Removing Conference Call Participants](#) on page 3-14.)
- **Info** – Provides additional information about the selected participant.
- **Far Mute** – Mutes the selected participant. The muted participant can hear all participants, but no participant can hear the muted participant.

Muting Conference Call Participants



To mute a conference call participant:

>> From the Manage Conference screen, scroll to the participant you want to mute, and then press the **Far Mute** soft key.

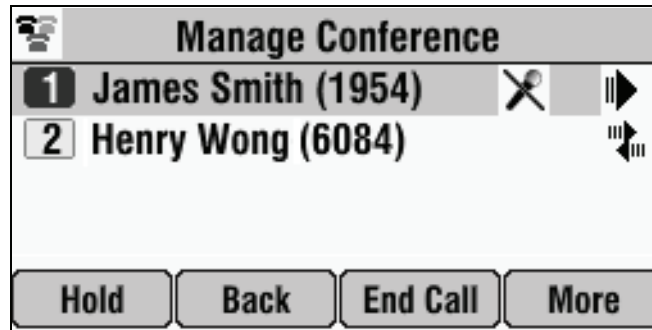
The following figure shows the far mute feature applied to James Smith. The “far mute” icon displays next to his name, and the UnMute soft key appears.



The muted participant can hear all participants, but no participant can hear the muted participant.

If you press  instead of the **Far Mute** soft key, all other participants can hear each other, but they cannot hear you. When you press , the LEDs glow red.

To un-mute the participant, press the **UnMute** soft key.

Placing Conference Call Participants on Hold

You can select a conference call participant and place the participant on hold. You can return the participant to the conference at any time by pressing the **Resume** soft key.

If you want to place a conference call on hold, see [Holding and Resuming Conferences](#) on page 3-15.

To place a conference call participant on hold:

- >> From the Manage Conference screen, scroll to the participant you want to place on hold, and then press the **Hold** soft key.

The following figure shows James Smith on hold. The “on hold” icon displays next to his name, and the Resume soft key appears.

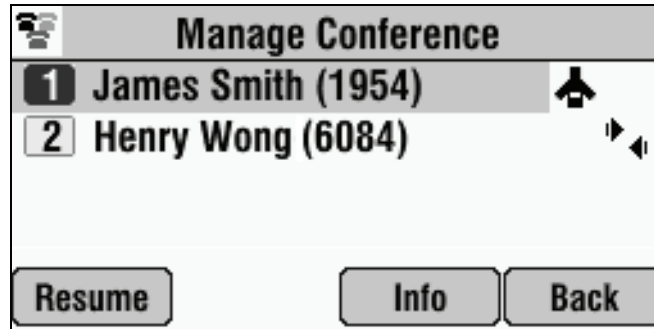

The held participant cannot hear any participants and no participant can hear the held participant.

To return the participant to the conference, scroll to the participant, and then press the **Resume** soft key.

If the held participant presses the Hold soft key on their phone, the participant will still be on hold even if you press the Resume soft key.

Removing Conference Call Participants

To remove a conference call participant:

>> From the Manage Conference screen, scroll to the participant you want to remove, and then press .

The participant is removed from the conference, the conference call ends, and the other participant becomes the active call.

Note

If you press the **End Call** soft key instead, you end the conference call. The other participants remain connected.

Obtaining Information About Conference Call Participants

You can display information about a conference call participant, such as their name and number, or if they are on hold.

To display information about a conference call participant:

1. From the Manage Conference screen, scroll to the participant whose information you want to obtain.
2. Press the **Info** soft key.

The Participant Info screen displays.

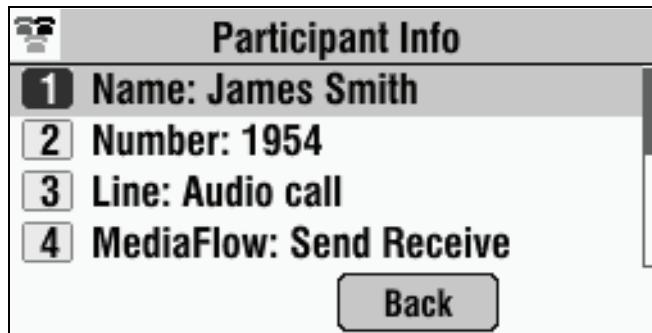

3. Press the **Back** soft key to return to the Manage Conference screen.

Holding and Resuming Conferences

When you place a conference call on hold, you place all other conference participants on hold. Conference call participants cannot hear each other.

To place an individual participant on hold, see [Placing Conference Call Participants on Hold](#) on page 3-13.

To place a conference call on hold:

- >> From the Active:Conference screen, press the **Hold** soft key.

The Hold:Conference screen displays. The other participants in the conference call are placed on hold.

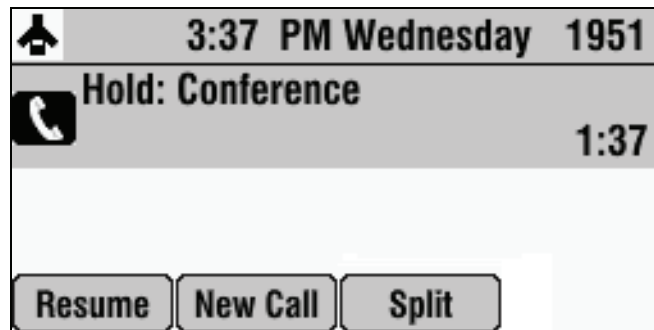

From the Hold:Conference screen, you can do the following:

- To resume the conference call, press the **Resume** soft key. The Active:Conference screen will display again.
- To place a call to a new person, press the **New Call** soft key. The conference remains on hold, and the new call becomes the active call.
- To end the conference call and place each conference participant on hold, press the **Split** soft key.

Splitting Conferences

When a conference is established, a Split soft key is available. When you split a conference, you end the conference and place all participants on hold.

To split a conference:

- >> From the Active:Conference or Hold:Conference screen, press the **Split** soft key.

The conference ends, and all calls are split into individual calls and placed on hold.

Ending Conferences

You can end a conference, and your connection to the other participants, by pressing the **End Call** soft key. When you use the End Call soft key, the other participants remain connected.

To end a conference:

- >> From the Active:Conference or Manage Conference screen, press the **End Call** soft key.

The two other participants remain connected.

Transferring Calls

A call can be transferred in one of three ways:

- Consultative transfer – You have the option of either talking to the person to whom you are transferring the call, or you can choose not to talk to the person, and complete the transfer when you hear the person’s ring-back sound.
 - [Performing a Consultative Transfer on page 3-17.](#)

- Blind transfer – The call is automatically transferred after you dial the number of the person to whom you want to transfer the call. You do not have the option of talking to the person.
 - [Performing a Blind Transfer](#) on page 3-18.
- Attended transfer – Conference call participants are automatically connected to each other after you exit a conference.
 - Set up a conference call and then end your participation. For more information, refer to [Ending Conferences](#) on page 3-16.

Performing a Consultative Transfer

Perform a consultative transfer if you want to talk to the person to whom you are transferring the call. Or, you can choose not to talk to the person. In this case, you wait for the person's ring-back sound, and then transfer the call.

To transfer a call:

1. During a call, press the **Transfer** soft key. The call is placed on hold. The Enter number screen displays.

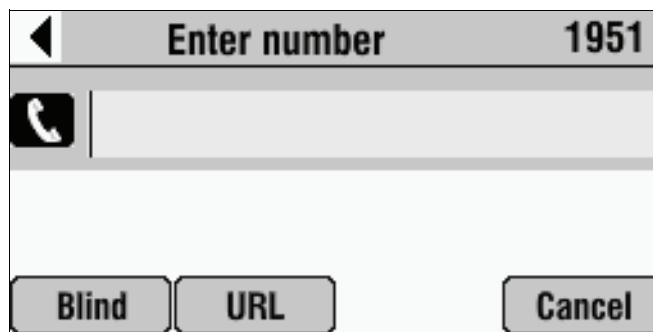

2. Place a call to the person to whom you want to transfer the call. See [Placing Calls](#) on page 3-2.
3. When you hear the ring-back sound, press the **Transfer** soft key. The transfer is complete. If you want to talk privately to the person to whom you are transferring the call before the transfer is complete, wait until the person answers the call, talk to the person, and then press the **Transfer** soft key.

You can cancel the transfer before the call connects by pressing the **Cancel** soft key.

Performing a Blind Transfer

When you use a blind transfer, you transfer a call without speaking to the person to whom you are transferring the call. The call is automatically transferred as soon as you dial the person's number.

To perform a blind transfer:

1. During a call, press the **Transfer** soft key.

The Enter number screen displays, with the Blind soft key.

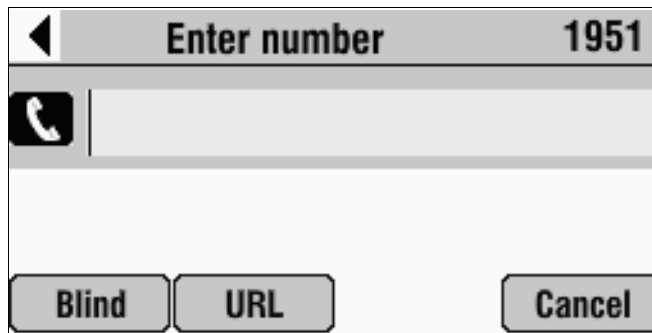

2. Press the **Blind** soft key.

The Blind transfer to screen displays.

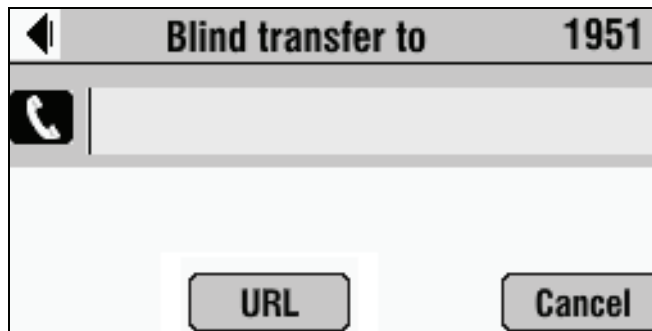

3. Place a call to the person to whom you want to transfer the call. See [Placing Calls](#) on page 3-2.

The call automatically transfers to the person you specified.

Forwarding Calls

Note

Your company's settings may override this feature. For more information, contact your system administrator.

Call forwarding is not available on shared lines.

You can set up your phone to forward incoming calls to another person (static forwarding) or you can forward a call as your phone rings (dynamic forwarding). Your phone will forward calls even if you enable the Do Not Disturb feature.

You can also reject calls from a particular contact (by sending the call to your voice mail system), or divert calls from a particular contact to another person. For more information, see [Managing Incoming Calls](#) on page 2-28.

Forwarding Calls Staticly

You can set up your phone to forward calls to another number.

To forward calls to another number:

1. Press , and then choose **Features > Forward**.

The Forwarding Type Select screen displays.

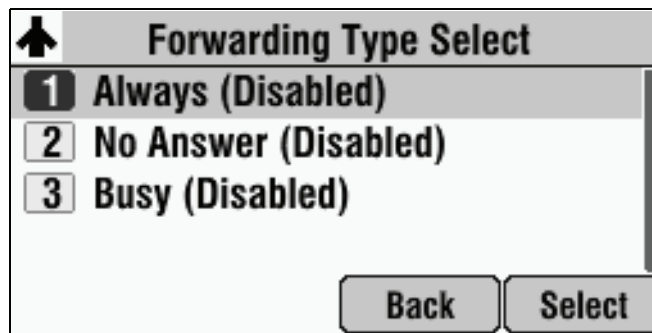

2. Scroll to the forwarding type you want, and then press **Select**. The options are:
 - **Always** – To forward all incoming calls.
 - **No Answer** – To forward all unanswered incoming calls.
 - **Busy** – To forward calls that arrive when you are already in a call.

3. Do one of the following:
 - If you selected **Always**, enter a number to forward all incoming calls to.
 - If you selected **No Answer**, do the following:
 - a In the **Contact** field, enter a number to forward all unanswered incoming calls to.
 - b In the **Forward After Rings** field, enter how many rings to wait before forwarding the call (one ring is approximately six seconds). The recommended value is two rings.
 - If you selected **Busy**, enter the number to forward all future incoming calls to when you are already in another call.
4. Press the **Enable** soft key.

If you selected the forwarding type **Always**, the text “**Call Forward Enabled**” and a moving arrow display on the idle screen next to the directory number.

To disable call forwarding:

1. Press , and then select **Features > Forward**.

The Forwarding Type Select screen displays.

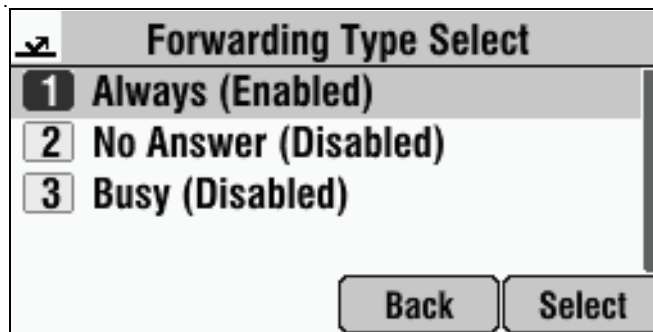

2. Scroll to the forwarding type you want to disable, and then press **Select**.
3. Press the **Disable** soft key.

Forwarding Calls Dynamically

You can manually forward a call to another number while your phone rings.

To forward an incoming call to another extension:

1. While your phone rings, press the **Forward** soft key.

The Call Forwarding screen displays.

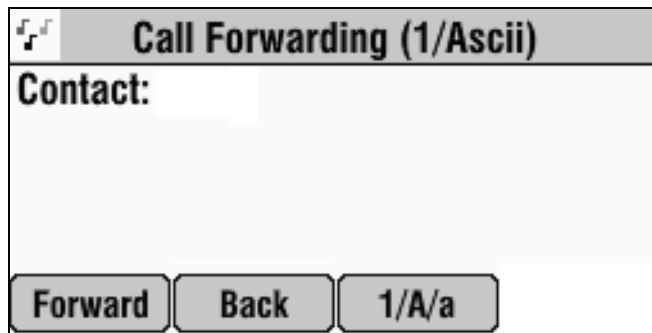

2. Enter the phone number to forward the incoming call to.

Your phone displays the last number you forwarded calls to (either statically or dynamically). If you previously set a forwarding number and want to enter a new one, use the << soft key to delete the number.

3. Press the **Forward** soft key.

The incoming call is forwarded to the other person. If call forwarding is disabled, all future calls will not be forwarded and forwarding will remain disabled.

Enabling Do Not Disturb

To prevent your phone from ringing, activate the Do Not Disturb feature.

Calls you receive while Do Not Disturb is enabled will display in your Missed Calls list (see [Using Call Lists](#) on page 2-14). If you have chosen to forward your calls to another number, calls will be sent to that number if you enable the Do Not Disturb feature.

To enable and disable Do Not Disturb:

1. Press , and then select **Features**.

The Features screen displays. If Do Not Disturb is not highlighted, scroll to it.



2. To toggle Do Not Disturb on and off, press **Select**.

When you enable Do Not Disturb, a flashing icon, , displays at the top left of the screen.

When you disable Do Not Disturb, the registered line icon, , displays instead.

3. Press  to return to the idle screen.

If you enabled Do Not Disturb, the idle screen displays **Do Not Disturb** and flashing icons next to the directory number.

The following figure shows what the idle screen looks like with Do Not Disturb enabled.

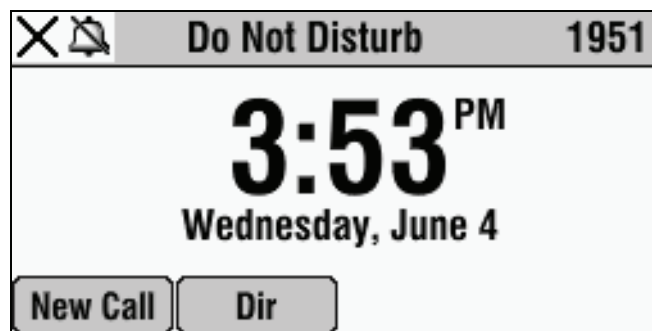

Managing Speed Dial Entries

Use the speed dial feature for fast, automated dialing. To use speed dial, you enter a speed dial index number instead of entering a complete phone number.

When you create a Contact Directory entry, the phone automatically assigns a Speed Dial index to the entry. You can change the index number, or delete it.

Note

Only entries in your Contact Directory can be set up as speed dial entries. To create a new Contact Directory entry with a speed dial index number, see [Adding Contacts to Your Local Contact Directory](#) on page 2-19.

The following steps describe how to update a speed dial entry for a contact. To place a call using a speed dial number, see [Placing Calls Using Speed Dial](#) on page 3-5.

To update a speed dial entry in your local Contact Directory:

1. Press the **Dir** soft key, and then select **Contact Directory**.
The Directory screen displays.

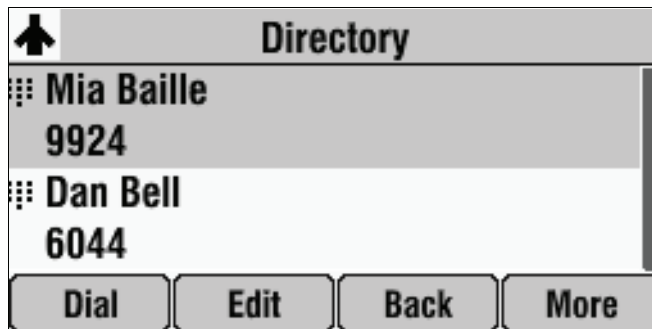

2. Scroll to the user's entry, and then press the **Edit** soft key.
The Edit Contact screen displays.

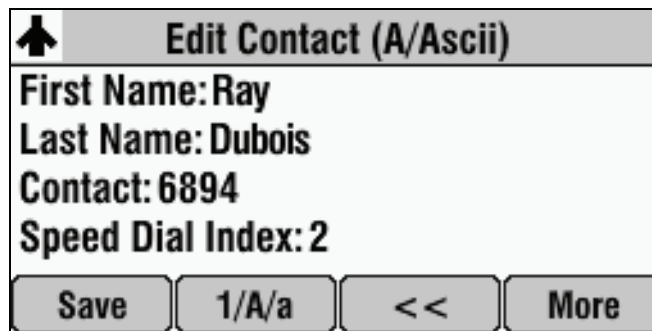

3. Scroll to **Speed Dial Index**, and then update the speed dial index number. Use the << soft key to update an existing entry.

You can assign any unused speed dial index number from 1 to 99. If you assign a speed dial index number that already exists, or you enter an invalid speed dial index number (for example, 0 or 00), an error message displays.

4. Press the **Save** soft key.
5. Press  twice to return to the idle screen.

Using Voice Mail

Note

Voice mail is an optional feature that your system administrator sets up. Your system may not support it. For more information, contact your system administrator. Screen options may vary with your application. Voice mail may be accessible with a single key press. Contact your system administrator about this option.

Your voice mail is saved in a centralized location and may be accessed from your phone. Your phone may indicate voice mail by the following:

- An icon, , on the phone screen
- A stutter dial tone instead of a normal dial tone

To listen to voice mail messages:

1. Press , and then select **Features > Messages > Message Center**.

The Messages screen displays.

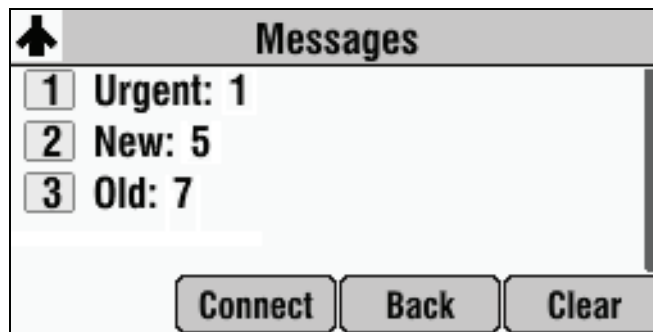

2. To listen to your voice mail, press the **Connect** soft key, and then follow the voice or visual prompts on the screen.
3. Press  to return to the idle screen.

Using the Advanced Features of Your Phone

This chapter provides operating instructions for the advanced features of your SoundStation IP 7000 conference phone. If you require additional information or assistance with these features, contact your system administrator.

For information on the basic features of your phone, refer to Chapter 3, [Using the Basic Features of Your Phone](#).

This chapter includes the following topics:

- [Using Computer or Mobile Audio with the Conference Phone](#) on page 4-1
- [Using the Phone When it is Connected to a Polycom HDX System](#) on page 4-7
- [Handling Multiple Call Appearances](#) on page 4-19
- [Using Buddy Lists](#) on page 4-20
- [Restarting the Phone](#) on page 4-26

Using Computer or Mobile Audio with the Conference Phone

You can connect audio from a computer calling application, or from a mobile phone, to your conference phone for hands-free conversations. You initiate and end conversations from your computer calling application or your mobile phone interface.

From your conference phone, you can do the following:

- Accept a computer or mobile audio source while you have an active call (including a conference call), or calls on hold.
- Place a computer or mobile audio source on hold.
- Join, split, and host conference calls between the calls on your conference phone and the computer or mobile audio source.
- Accept calls from other phones while you listen to computer or mobile audio.

If you connect your computer calling application or mobile phone to your conference phone when your conference phone is idle, the computer or mobile audio automatically becomes the active call, and you immediately hear any audio associated with the mobile phone or computer calling application.

The following figure shows the conference phone screen if the conference phone is idle and you connect your computer calling application or mobile phone to it. You can place the computer or mobile audio on hold (and then initiate a new call or conference call), or accept a call from another phone while you listen to computer or mobile audio.

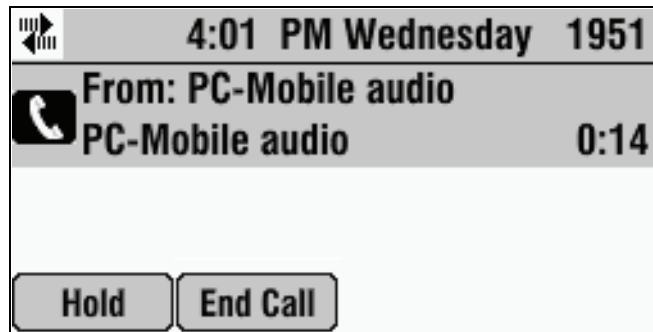

Note

Audio from computer calling applications or mobile phones does not display in your conference phone Call Lists.

For information on how to connect your conference phone (in a single or two-phone setup) to computer calling applications and mobile phones, see [Connecting Optional Auxiliary Audio Components](#) on page 1-9.

Note

You can use your conference phone that is connected to a computer calling application or a mobile phone to handle video calls and conferences. See [Handling Computer or Mobile Audio When Your Phone is Connected to a Polycom HDX System](#) on page 4-19.

Listening to Computer or Mobile Audio

You can connect the computer or mobile audio source while your conference phone is in an idle state, or when you have an active call.

To listen to computer or mobile audio when your conference phone is idle:

- >> When your conference phone is idle, connect the mobile phone or computer calling application to your conference phone. (See [Connecting Optional Auxiliary Audio Components](#) on page 1-9.)

The computer or mobile audio automatically becomes the active call, and you can hear any audio associated with the computer calling application or mobile phone. If there isn't any audio, you can wait for a call, answer it from your computer calling application or mobile phone interface, and then listen to the audio on your conference phone.

The following figure shows what the screen looks like when you connect a computer calling application or mobile phone (with or without a current call) to the conference phone when the conference phone is idle.

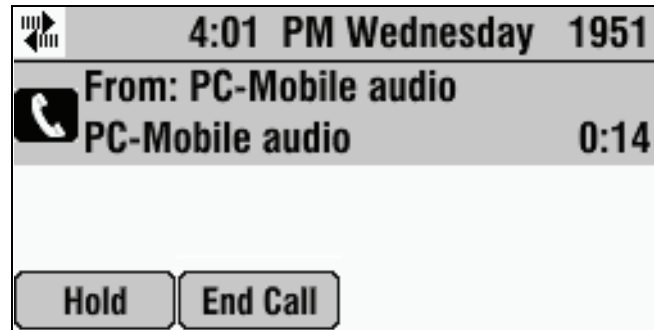

To listen to computer or mobile audio when the conference phone has another call:

1. Do one of the following:
 - While the conference phone has an active call, connect the computer calling application or mobile phone to the conference phone. (See [Connecting Optional Auxiliary Audio Components](#) on page 1-9.)

The conference phone screen shows a computer or mobile audio source. The LEDs blink green to indicate the audio source.

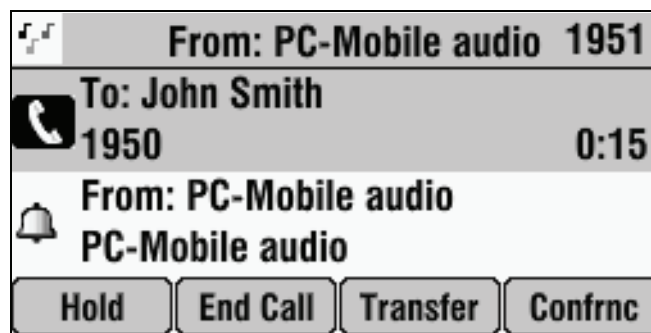

or

- If the conference phone has a call on hold, connect the computer calling application or mobile phone to the conference phone. (See [Connecting Optional Auxiliary Audio Components](#) on page 1-9.)

The conference phone screen shows a computer or mobile audio source. The LEDs blink green to indicate the audio source.

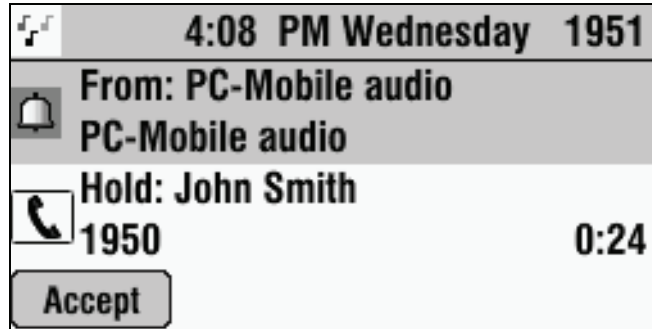

2. Do one of the following:

- If the conference phone has an active call, press the **Hold** soft key.

The active call is placed on hold, and the computer or mobile audio becomes the active call.

or

- If the conference phone has a call on hold, press the **Accept** soft key.

The computer or mobile audio becomes the active call.

You can place the computer or mobile audio on hold, or use the Join soft key to create a conference call with the call on hold and the computer or mobile audio.

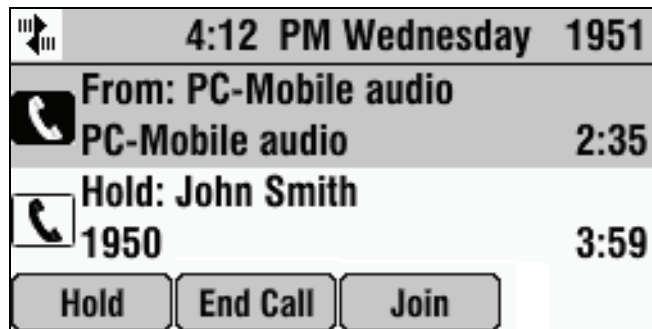

Ending Computer or Mobile Audio

To remove the computer or mobile audio source, disconnect the Computer Calling Cable or Mobile Phone Cable from the conference phone.

If you want to keep the connection for future computer or mobile audio calls, end the call from your computer or mobile phone, but do not remove the Computer Calling Cable or Mobile Phone Cable. The conference phone screen will still display “From:PC-Mobile audio,” and the computer or mobile audio will continue to be the active call.

Placing Computer or Mobile Audio on Hold

To place computer or mobile audio on hold:

>> From your conference phone, scroll to **PC-Mobile audio**, and then press the **Hold** soft key. If you want, you can place a new call, or create a conference between the computer or mobile audio and another person.

Press the **Resume** soft key to make the computer or mobile audio active again.

Creating Conference Calls with Computer or Mobile Audio

You can set up conference calls with computer or mobile audio using the **Cnfrnc** or **Join** soft key.

To create a conference call with a computer or mobile audio source, do one of the following:

- If you have an active computer or mobile audio source, place the call on hold, and then use the **Cnfrnc** soft key to set up a conference. See [Hosting Conference Calls](#) on page 3-9.
- If you have an active computer or mobile audio source and another call on hold, scroll to the call on hold, and then press the **Join** soft key.
- If you have an active conference call, and you connect computer or mobile audio, scroll to the incoming computer or mobile audio, and then press the **Join** soft key.

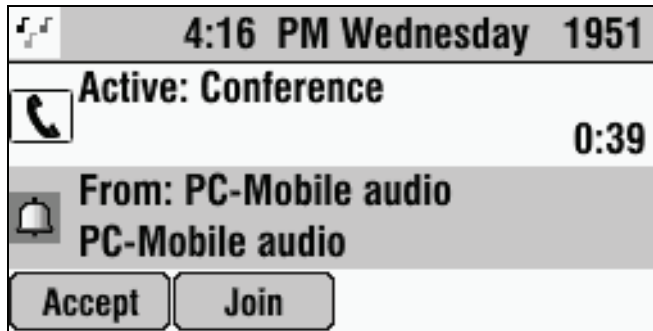

The following figure shows the Join soft key that displays when there is an active conference call and an incoming computer or mobile audio source.



You manage conference calls with computer or mobile audio just as you do with other phone calls. For detailed information on setting up conferences using the Confrnc and Join soft keys, as well as managing conference calls, see [Hosting Conference Calls](#) on page 3-9.

Adjusting the Volume of Computer or Mobile Audio

To adjust the speaker volume:

>> While you listen to computer or mobile audio, press either  or  to adjust the speaker volume.

To mute the microphone:

>> While you listen to computer or mobile audio, press .

The LEDs glow red to indicate that the other person (or people) cannot hear you. You can still hear all other people while Mute is enabled.

To turn off the Mute feature, press  again.

Using the Phone When it is Connected to a Polycom HDX System

Note

This section describes how to use your phone when it is connected to a Polycom HDX system. For detailed information on how to use a Polycom HDX system, see the Polycom HDX documentation at www.polycom.com/vidеodocumentation.

You can connect your phone to Polycom HDX systems that run software version 2.5 or later. Your phone must run SIP application 3.1.1 or later.

You can perform many of the following phone functions using your Polycom HDX system's remote control or keypad. For detailed information on how to use the remote control or keypad, see the user guide for your Polycom HDX system at www.polycom.com/vidеodocumentation.

You can set up your phone with a Polycom HDX system so that your phone can conduct video calls and conferences.

When you connect your phone to a Polycom HDX system, your phone displays different soft keys:

- Video – Allows you to place a video call
- Phone – Allows you to place an audio-only call
- Content – Allows you to show content to near-site participants, as well as to far-site participants with whom you are exchanging video.
- Add Video – Allows you to establish a conference between yourself, an active call or call on hold, and the new person you dial. Or, automatically joins the new person you dial to an active conference.
- Add Phone – When an audio-only call is active or on hold, allows you to add an additional call to your phone. If you have a video call, pressing the Add Phone soft key automatically creates a conference between yourself, the video call, and the new person you dial.

Note

When your phone is connected to a Polycom HDX system, there is no New Call soft key. To initiate a call, press the Video or Phone soft keys. For more information, see [Placing Calls When Your Phone is Connected to a Polycom HDX System](#) on page 4-9 and [Ending Calls When Your Phone is Connected to a Polycom HDX System](#) on page 4-13.

A video call or a video conference (a conference that has at least one video call), displays the video icon, .

The following figure shows a video call to Jacklyn Smith.

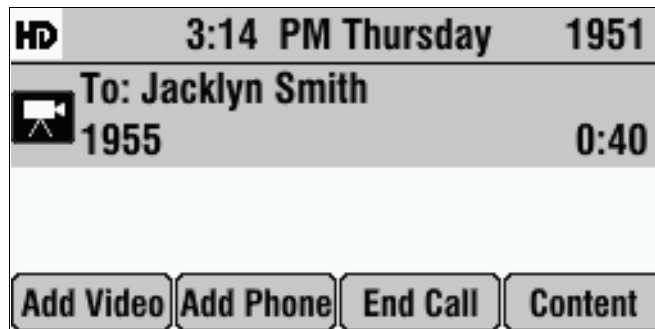

The following figure shows an active conference call in which one participant is connecting with video.

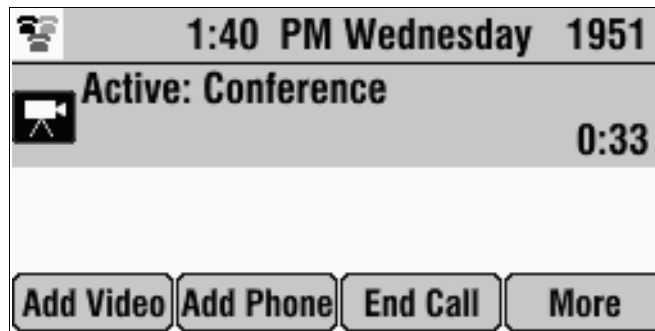

The video icon, , also displays next to video calls in call lists.

The following figure shows a Placed Calls list. The call to John Smith used video.

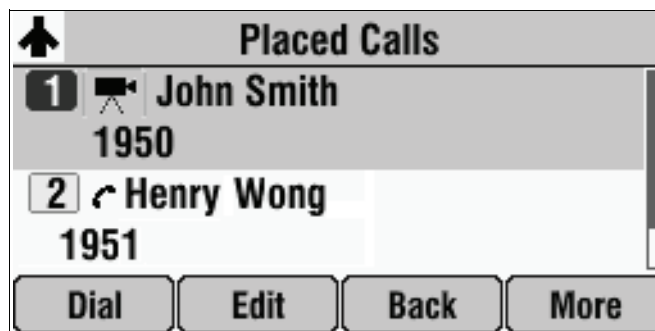

Placing Calls When Your Phone is Connected to a Polycom HDX System

You can place a call when your phone is idle, when you have an active call, or when you have a call on hold.

Placing Calls When You Don't Have Any Active Calls

When you place a call, you must specify if the call will be an audio-only call or a video call.

To place a call when you don't have any active calls:

1. Do one of the following:

- Press .

The message “Video or Phone Call?” displays. To place a video call, press the **Video** soft key. To place an audio-only call, press the **Phone** soft key.

or

- To place a video call, press the **Video** soft key. To place an audio-only call, press the **Phone** soft key.

2. Do one of the following:

- To enter a phone number, enter the number of the person you want to call.

or

- To enter an IP address or URL:

Note

Placing a call using an IP address or URL may not be enabled for your phone. For more information, see your system administrator.

If you are making an audio-only call, press the **URL** soft key. Then, toggle the **ABC** and **123** soft keys to enter the URL or IP address of the person you want to call.

If you are making a video call, toggle the **ABC** and **123** soft keys to enter the URL or IP address of the person you want to call.

You can switch between entering a number or IP address, or a URL, by pressing the **123** and **ABC** soft keys.

To enter the letters that display on a number key, press the number key one or more times.

For example, to enter “a,” press  once. To enter “c,” press

 three times quickly.

To enter “.” and “@”, press  one or more times quickly.

3. Press  or the **Dial** soft key.

The following figure shows a video call to Jacklyn Smith.

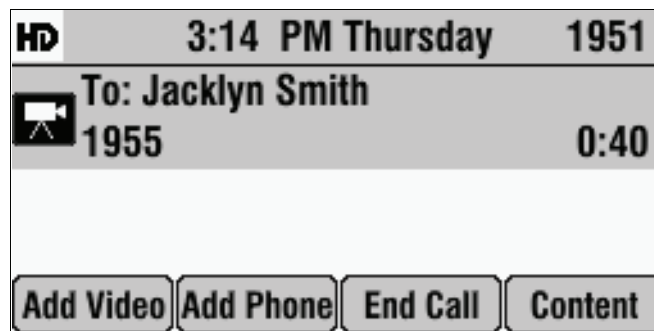

Placing Calls When You Have an Audio-Only Call on Hold

Note Only audio-only calls can be on hold. Video calls cannot be on hold.

When an audio-only call is on hold, you can place a separate audio-only call or video call without setting up a conference. When the call is placed, the phone will display the call on hold and the active call.

To place a call when you have a call on hold:

>> With an audio-only call on hold, place a call (see [Placing Calls When You Don't Have Any Active Calls](#) on page 4-9.)

When the other person answers the call, the phone displays a call on hold and an active call.

The following figure shows a video call and an audio-only call on hold.

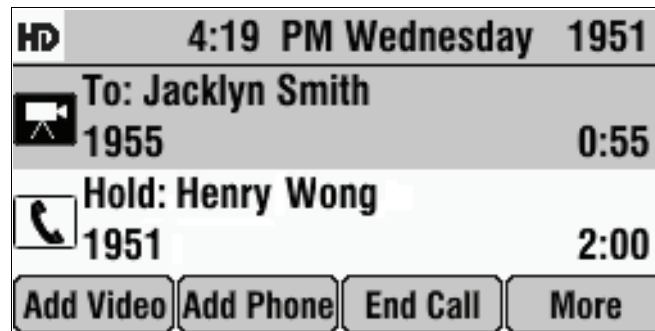

Placing Calls When You Have an Active Audio-only Call or a Video Call

If you place a call when you have an active audio-only call or video call, you automatically create a conference between yourself, the active call or video call, and the new person you call. For more information, see [To set up a conference using the Add Phone or Add Video soft keys: on page 4-15](#).

If you have an active audio-only call, you can choose not to create a conference. You can place the active call on hold, and then place a separate call to another person (see [Placing Calls When You Have an Audio-Only Call on Hold on page 4-10](#)).

Placing Calls Using Call Lists, Directories, Speed Dial Index Numbers, and the Redial Key When Your Phone is Connected to a Polycom HDX System

Instead of entering phone numbers, URLs, and IP addresses from memory, you can access call lists, directories, and speed dial lists to place calls to audio-only and video endpoints. You can also redial numbers. For more information, see [Placing Calls on page 3-2](#) and [Redialing Numbers on page 3-7](#).

Note

The directories on your phone and on the Polycom HDX system are not integrated. Directory entries on the phone do not display on the Polycom HDX system, and directory entries on the Polycom HDX system do not display on the phone.

Answering Calls When Your Phone is Connected to a Polycom HDX System

Answering Calls When You Don't Have Any Active Calls

You answer an incoming call in the same way you answer calls if your system is not connected to a Polycom HDX system.

To answer an incoming call:

>> Press  or the **Answer** soft key. For more information, see [Answering Calls](#) on page 3-6.

Answering Calls When You Have an Audio-Only Call on Hold

Note

Only audio-only calls can be on hold. Video calls cannot be on hold.

When you answer a call when you have an audio-only call on hold, your phone displays two call appearances: one for the call on hold, and one for the active call.

To answer an incoming call when you have a call on hold:

>> Press  or the **Answer** soft key.

The following figure shows a video call and an audio-only call on hold.

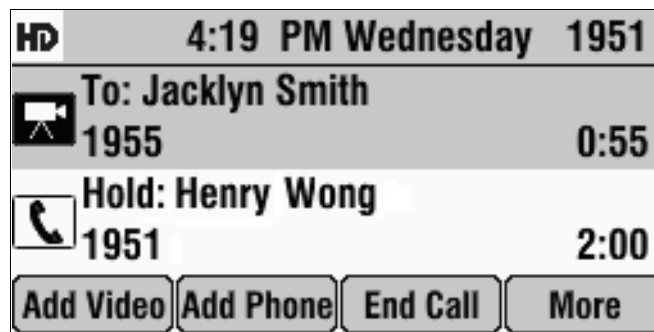

If you want to create a conference between the call on hold (audio-only) and an active audio-only or video call, scroll to either call, and then press the **Join** soft key.

Answering Calls When You Have an Active Call

If you answer a call when you have a video call, a conference is automatically created between yourself, the video call, and the call you answer.

If you answer a call when you have an active audio-only call, the phone places the active call on hold, and the call you answer becomes the active call.

To answer a call when you have an active call:

>> Do one of the following:

- If you have a video call, and an incoming call arrives, press  or the **Join** soft key.

A conference is automatically created between yourself, the video call, and the call you answer.

or

- If you have an active audio-only call, and an incoming call arrives, press  or the **Answer** soft key.

The active call is placed on hold, and the new call becomes the active call. The phone displays two call appearances: one for the call on hold, and one for the active call.

Ending Calls When Your Phone is Connected to a Polycom HDX System

To end a call:

>> Scroll to the call, and then press  or the **End Call** soft key.

To end a call on hold, scroll to the call on hold, press the **Resume** soft key, and then press  or the **End Call** soft key.

To end a call to a conference call participant, see [Managing Conferences](#) on page 4-17.

Holding Calls When Your Phone is Connected to a Polycom HDX System

You cannot place video calls on hold. To place audio-only calls on hold, see [Holding and Resuming Calls](#) on page 3-8.

Transferring Calls When Your Phone is Connected to a Polycom HDX System

You cannot transfer video calls. You can transfer audio-only calls only if there are no other video calls or conferences. To transfer audio-only calls, see [Transferring Calls](#) on page 3-16.

Forwarding Calls When Your Phone is Connected to a Polycom HDX System

You cannot forward video calls. To forward audio-only calls, see [Forwarding Calls](#) on page 3-19.

Enabling Do Not Disturb When Your Phone is Connected to a Polycom HDX System

To prevent audio-only calls from ringing on your phone, activate the Do Not Disturb feature.

Audio-only calls you receive while Do Not Disturb is enabled will display in your Missed Calls list. If you have chosen to forward audio-only calls to another number, those calls will be sent to that number if you enable the Do Not Disturb feature.

To enable Do Not Disturb, see [Enabling Do Not Disturb](#) on page 3-21.

Rejecting Calls When Your Phone is Connected to a Polycom HDX System

You can ignore incoming audio-only and video calls.

To ignore incoming calls:

>> Press the **Reject** soft key.

Hosting Conference Calls When Your Phone is Connected to a Polycom HDX System

You can create a conference with up to two other people that connect by audio only and a multiple number of sites that connect by video (the exact number of video calls you can add is determined by your system setup). At most, a conference call can have two audio-only calls and multiple video calls.

The following figure shows a video conference. The video icon, , displays when at least one conference participant connects by video.

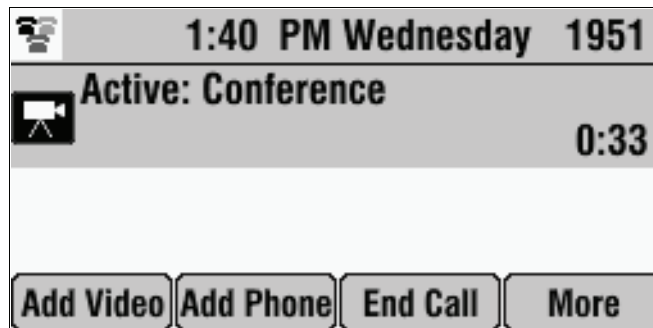

The following figure shows an audio-only conference. The handset icon, , displays when all conference call participants connect using audio-only endpoints.

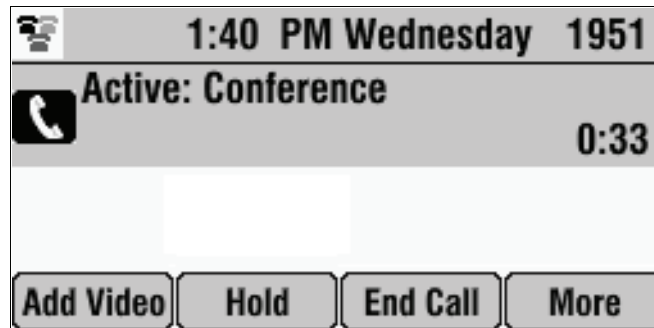

Setting Up Conferences

You can set up a conference in two ways:

- If you have no active calls, or you have an active call or conference, use the Add Phone or Add Video soft keys.
- If you have an audio-only call on hold and an active call, use the Join soft key.

To set up a conference using the Add Phone or Add Video soft keys:

1. Call the first person. See [Placing Calls When Your Phone is Connected to a Polycom HDX System](#) on page 4-9.

The following figure shows a video call to Jacklyn Smith.

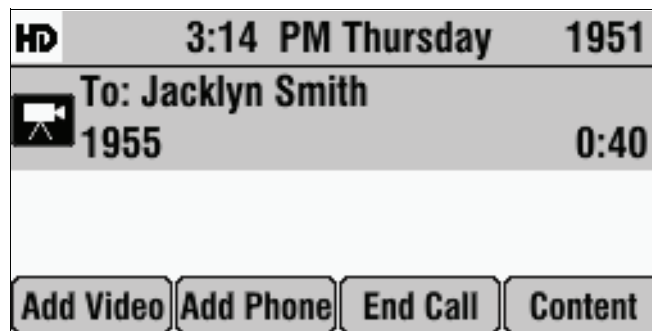

2. Place a call to the second person:

- a** To place a video call, press the **Add Video** soft key. To place an audio-only call, press the **Add Phone** soft key.
- b** Enter the number of the phone, and then press the **Dial** soft key. (For more information on placing calls, including how to enter IP addresses or URLs, see [Placing Calls When Your Phone is Connected to a Polycom HDX System](#) on page 4-9.)

The call is placed, and an active conference is automatically created.

To continue to add people to an established conference, do the following:

- To continue to add audio-only calls, press the **Add Phone** soft key from the Active:Conference screen, and then place the call to the person you want to add to the conference. When the person answers, the person automatically joins the conference.

The Add Phone soft key does not display when the maximum number of audio-only calls (two) has been added to the conference.

- To continue to add video calls, press the **Add Video** soft key from the Active:Conference screen, and then place a call to the site you want to add to the conference. When the site answers, the people automatically join the conference.

Note

If you have an active audio-only call, you can choose not to create a conference. You can place the active call on hold, and then place the call to the new person (see [Placing Calls When You Have an Audio-Only Call on Hold](#) on page 4-10).

A conference is automatically created when you have a video call and you answer an incoming call. See [Answering Calls When You Have an Active Call](#) on page 4-12.

To create a conference using the Join soft key:

- >> If you have an active audio-only or video call or conference, and an audio-only call or conference on hold, scroll to either call, and then press the **Join** soft key.

An active conference is created.

Handling Active Conferences

You handle active audio-only and video conferences differently.

You handle active audio-only conferences in the same way as you handle conferences for phones that are not connected to a Polycom HDX system (see [Hosting Conference Calls](#) on page 3-9). Except, an Add Video soft key displays so you can add additional video endpoints to the conference.

During a video conference:

- The Hold and Split soft keys are not available. You cannot place the conference on hold, or end the conference by pressing the Split soft key and placing all conference call participants on hold.
- The Add Phone and Add Video soft key display so you can add additional people to the conference. (The Add Phone soft key does not display if you have already added two audio-only calls to the conference.)
- The Content soft key displays. (See [Showing Content When Your Phone is Connected to a Polycom HDX System](#) on page 4-18.)

Managing Conferences

The Manage soft key is available for both active audio-only and video conferences.

You manage audio-only and video conferences in the same way as you manage conferences for phones that are not connected to a Polycom HDX system. Except, for video conferences, the Hold and Far Mute soft keys are not available. For video conferences, you only have access to the Info, End Call, Content, and Back soft keys. For information on how to use these soft keys and manage conferences, see [Managing Conferences](#) on page 3-11.

Controlling Volume and Muting Calls When Your Phone is Connected to a Polycom HDX System

When your phone is connected to a Polycom HDX system, all audio-only calls and conferences use your phone's speaker. Any video calls (or conference calls that connect to at least one video endpoint) use the Polycom HDX system's speaker. As well, your phone (and attached external microphone, if applicable) act as the microphone for all calls.

To adjust the volume of calls and to mute the near site, see [Adjusting the Speaker and Ringer Volume](#) on page 2-14 and [Muting the Microphone](#) on page 3-7.

Note

When you press the Mute button on the phone, or on any extended microphone or Polycom HDX Microphone Array, you mute the microphone on the phone and all extended microphones and Polycom HDX Microphone Arrays connected to your phone and to the Polycom HDX system. A Mute icon displays on both the phone and Polycom HDX system screens. (You will not mute audio from other sources, such as a computer, VCR, or DVD player.)

You can also control the volume and mute microphones (including your phone's microphones) using the Polycom HDX system's remote control or keypad. For more information, see the user's guide for your Polycom HDX system at www.polycom.com/videodocumentation.

Showing Content When Your Phone is Connected to a Polycom HDX System

A Content soft key displays on your phone so that you can show content to near-site participants, as well as to near-site and far-site video participants during a video call or conference. The Content soft key displays when your phone is idle, or when you have a call.

Depending on the Polycom HDX system you have, you may be able to show the following:

- Information stored on a computer.
- A paper document or object placed on a document camera.
- A videotape or DVD.

For information on how to connect a computer, document camera, VCR, or DVD player to a Polycom HDX system so you can show content, see your system administrator.

For detailed information on how to show content, see the user guide for your system at www.polycom.com/videodocumentation.

To start and stop showing content:

Press the **Content** soft key.

Handling Multiple Call Appearances When Your Phone is Connected to a Polycom HDX System

When your phone is connected to a Polycom HDX system, the following applies:

- You cannot place video calls (or conferences) on hold. Therefore, you cannot have multiple video call (or conference) appearances.
- Your phone can handle up to eight audio-only call appearances, or seven audio-only appearances (on hold) and one video call appearance.

For more information on multiple call appearances, see [Handling Multiple Call Appearances](#) on page 4-19.

Handling Computer or Mobile Audio When Your Phone is Connected to a Polycom HDX System

When your phone is connected to a Polycom HDX system, your phone handles computer or mobile audio just like an audio-only call.

You handle computer or mobile audio when your phone is connected to a Polycom HDX system in the same way you handle computer or mobile audio when your phone operates as a standalone system (see [Using Computer or Mobile Audio with the Conference Phone](#) on page 4-1). Except, the video soft keys display instead.

Handling Multiple Call Appearances

Your system administrator can set up your phone to have one or more call appearances. If your phone is set up to have multiple call appearances, your phone screen can display information for multiple calls, and you can handle active and held calls at the same time. Your phone can handle a maximum of eight different calls, or eight “appearances,” at one time.

The following figure shows what the phone screen looks like with multiple appearances set up. The figure shows an active call with extension 1955, and a call on hold with extension 1951.

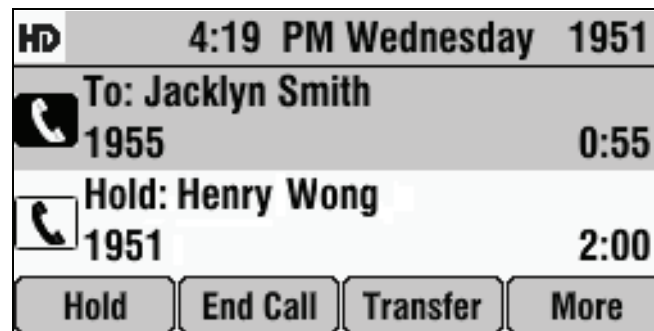

If three or more calls are taking place, the phone displays a counter at the top left of the screen. For example, in the following figure, “1/3” indicates that the call to John Smith is the first one out of a total of three. To select the other two calls, press the **Up** or **Down** scroll keys.

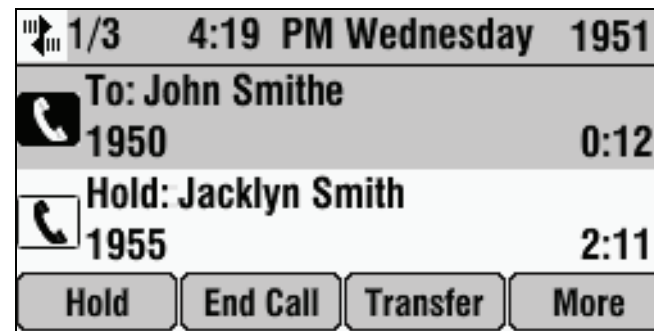

Using Buddy Lists

Note

Monitoring the status (presence) of contacts in a buddy list is an optional feature that your system administrator enables. Your system may not support it. For more information, contact your system administrator.

A buddy list is a list of users/devices whose status, or “presence,” you can monitor. Users update their presence setting (for example, Be right back, Out to lunch, or Busy), and you can view their status in real time from your phone’s Buddy Status screen. If you like, you can block others from monitoring your status.

Your phone can “watch” the status of up to eight other phones. These phones form your “Buddy List.” Your phone can be monitored by up to eight other phones.

If your phone is configured to work with Microsoft Office Live Communications Server 2005, the behavior of presence settings and buddy lists is different. For more information, see [Integrating With Microsoft Office Live Communications Server 2005](#) on page 4-25, or contact your system administrator.

Updating Presence Settings

Your presence setting indicates your status (either online, busy, be right back, away, on the phone, out to lunch, or offline). Update your presence setting so that other users can monitor your status from their phones.

To change your presence setting:

1. Do one of the following:

– Press , and then choose **Features > Presence > My Status**.

or

– Press the **MyStat** soft key.

The My Status screen displays.

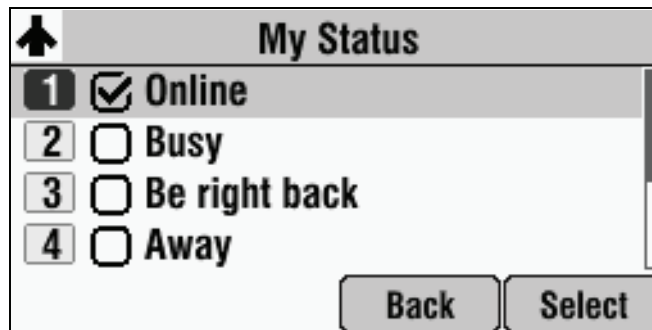

2. Scroll to the status you want, and then press **Select**.
3. Press  to return to the idle screen.

The following figure shows what the phone screen looks like when you assign a presence status (in this case, “Busy”). If you assign the status “Online” (the default status) or “On the phone,” the presence status does not display on your screen.



Selecting Contacts to Monitor

Select the contacts whose presence you want to monitor by updating the contacts in your buddy list. You add contacts to your buddy list from your local Contact Directory.

Note

If your call server is Microsoft Office Live Communications Server 2005, see [Integrating With Microsoft Office Live Communications Server 2005](#) on page 4-25.

To update your buddy list:

1. Press the **Dir** soft key, and then select **Contact Directory**.

The Directory screen displays.

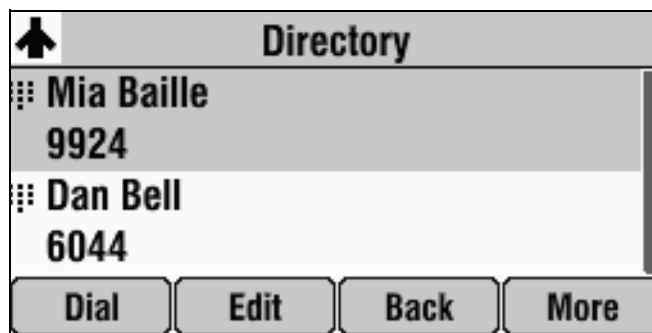

2. Scroll to find the contact. Or, search for the contact (see [Searching for Contacts in Your Local Contact Directory](#) on page 2-23).

You can use the * key to Page Up and the # key to Page Down.

3. Press the **Edit** soft key.

The Edit Contact screen displays.

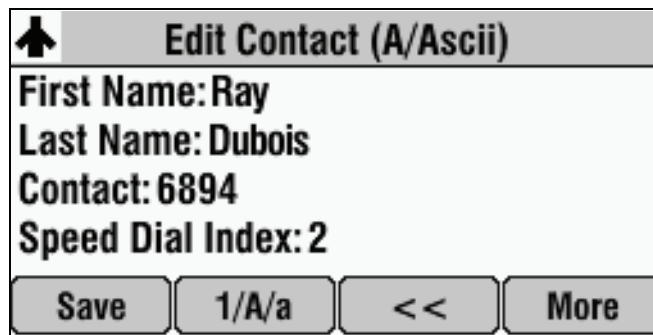

4. Scroll to **Watch Buddy**, and then press the **Right** or **Left** scroll key to choose **Enabled** or **Disabled**.

When Watch Buddy is enabled, the contact is added to your buddy list and you can monitor the contact's status. When Watch Buddy is disabled, the contact is removed from your buddy list and you cannot monitor the contact's status.

The default for Watch Buddy is Disabled.

5. Press the **Save** soft key.
6. Press  twice to return to the idle screen.

If you enable the Watch Buddy setting for a contact, the contact will display on your Buddy Status screen. To view your Buddy Status screen, press the **Buddies** soft key from the idle screen.

Blocking Contacts From Viewing Your Status

Block a contact in your Contact Directory if you don't want the contact to view your status. If you unblock a contact, the contact can add you to their buddy list and view your status.

Note

To view a list of contacts that can and cannot monitor your status, do the following:

- To view contacts that cannot view your status, press the **Menu** key, and then select **Features > Presence > Blocked List**.
- To view contacts that can view your status, press the **Menu** key, and then select **Features > Presence > Watcher List**.

To block or unblock a contact from viewing your status:

1. Press the **Dir** soft key, and then select **Contact Directory**.

The Directory screen displays.

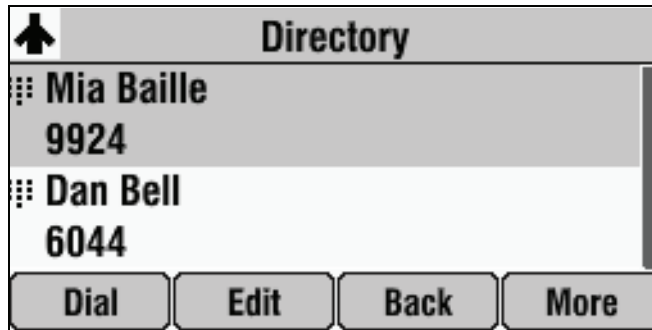

2. Scroll to find the contact. Or, search for the contact (see [Searching for Contacts in Your Local Contact Directory](#) on page 2-23).

You can use the * key to Page Up and the # key to Page Down.

3. Press the **Edit** soft key.

The Edit Contact screen displays.

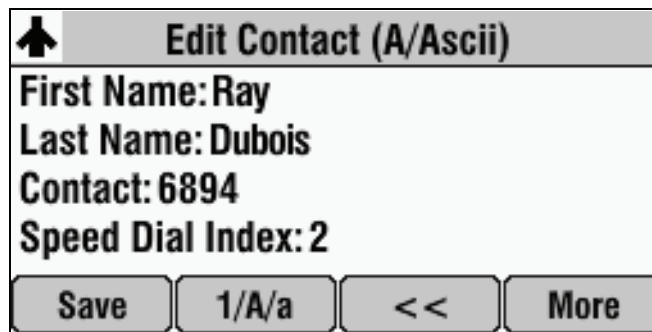

4. Scroll to **Block Buddy**, and then press the **Right** or **Left** scroll key to choose **Enabled** or **Disabled**.

When Block Buddy is enabled, the contact cannot watch your status. The contact will display in your Blocked List.

When Block Buddy is disabled, the contact can watch your status. The contact will display in your Watcher List.

The default for Block Buddy is Disabled.

5. Press the **Save** soft key.

6. Press  twice to return to the idle screen.

Using your Blocked List to Unblock Contacts

You can use your Blocked List to unblock a contact, so the contact can view your status. Use the Blocked List to quickly unblock a contact, rather than updating the Contact Directory.

To use your Blocked List to unblock a contact:

1. Press , and then select **Features > Presence > Blocked List**.

The Blocked List screen displays.

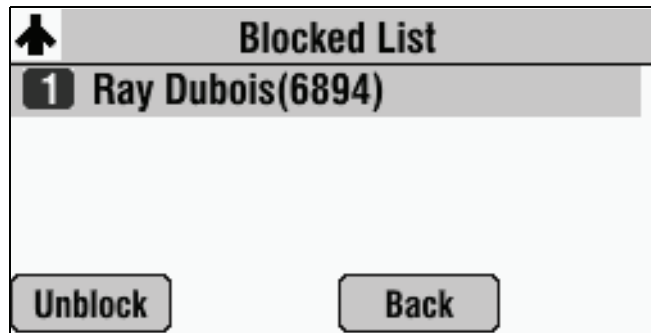

2. Scroll to the contact, and then press the **Unblock** soft key.
3. Press  to return to the idle screen.

The contact can now watch your phone. The contact will display in your Watcher List. (To view your Watcher List, see [Blocking Contacts From Viewing Your Status](#) on page 4-22.)

Monitoring the Status of Contacts in Your Buddy List

You can monitor the status of all the contacts in your buddy list, except those contacts that have blocked you from viewing their status. To add contacts to your buddy list, see [Selecting Contacts to Monitor](#) on page 4-21.

To monitor a contact in your buddy list:

>> Do one of the following:

- From the idle screen, press the **Buddies** soft key.

or

- Press , and then select **Features > Presence > Buddy Status**.

The Buddy Status screen displays, listing the status of all your buddies.

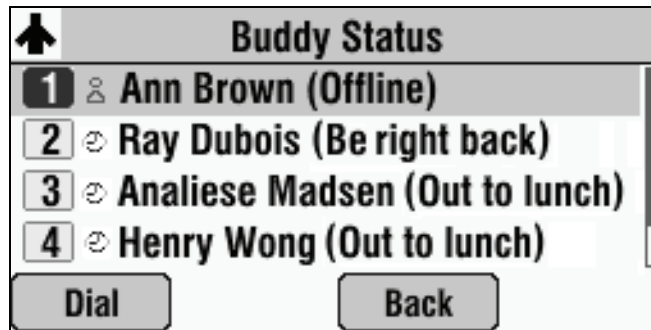



Integrating With Microsoft Office Live Communications Server 2005

Your system administrator can configure your phone to work with Microsoft Office Live Communications Server 2005 and communicate with others using Microsoft Office Communicator and Windows Messenger. From your phone, you can invite, join, control, and monitor integrated multipoint conferences.

Any contacts added through your buddy list will appear as a contact in Microsoft Office Communicator and Windows Messenger. Any contacts added as a contact in Microsoft Office Communicator and Windows Messenger will appear in your buddy list. You can access your Privacy List on the phone to allow or disallow your contacts from monitoring your presence.

To view and change your presence, see [Updating Presence Settings](#) on page 4-20. For more information on integrating with Microsoft Office Live Communications Server 2005, contact your system administrator.

To add a contact to your buddy list:

1. Press , and then choose **Features > Presence > Buddy Status**.
2. Press the **Add** soft key.
3. Enter the phone number of the contact.
4. Press the **Submit** soft key.
5. Press  to return to the idle screen.

To view and change your privacy list:

1. Press , and then choose **Features > Presence > Buddy Status > Privacy List**.
2. Scroll to the contact.
3. Press the **Edit** soft key.
4. Scroll to **Access**, and then press the **Up** or **Down** scroll key to select **Enabled**.

When Access is enabled, you allow the contact to see your presence. When Access is disabled, you prevent the contact from seeing your presence.

The default for Access is Disabled.

5. Press  to return to the idle screen.

For more information, see the Microsoft Office Communicator and Windows Messenger documentation.

Restarting the Phone

Note

If your phone malfunctions, you may be able to restore normal operation without restarting it. Before you restart your phone, contact your system administrator.

Periodically, you may need to restart your phone so your phone can accept a new configuration.

Note

Call lists are automatically cleared when you restart your phone.

To restart the phone:

1. Press , and then select **Settings > Basic > Restart Phone**.

The Restart Phone screen displays. The message “Are you sure?” displays.

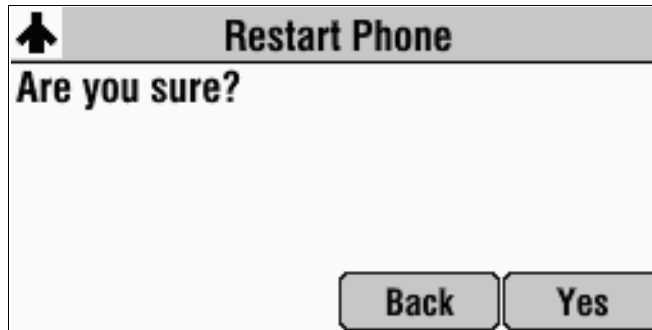

2. If you still want to restart the phone, press the **Yes** soft key.

The restart process begins. The process ends when the idle screen displays.

Troubleshooting Your Phone

This chapter contains general troubleshooting information to help you solve any problems you might encounter when you use the SoundStation IP 7000 conference phone. The tables in this chapter list possible trouble symptoms, the likely causes of these problems, and recommended corrective actions to take. Problems are grouped as follows:

- [Installation Configuration](#) on page 5-2
- [Power and Startup](#) on page 5-3
- [Controls](#) on page 5-4
- [Access to Screens and Systems](#) on page 5-5
- [Calling](#) on page 5-6
- [Displays](#) on page 5-7
- [Audio](#) on page 5-7

To obtain more detailed troubleshooting information, you can access certain menus on your phone that test your phone hardware. For more information, see [Testing Phone Hardware](#) on page 5-7.

If you require more information or assistance, contact your system administrator.

Installation Configuration

Symptom	Problem	Corrective Action
The display shows: “General configuration error Unsupported configuration Undo last configuration change”	The phone installation configuration is not supported.	Verify that you have installed the phone(s) and any components correctly: <ul style="list-style-type: none">• Check that no more than two phones are connected together.• Check that no more than two extension microphones are installed. If your conference room setup has two connected phones, check that only one extension microphone is installed.• Refer to Installing the Phone on page 1-3.• Contact your system administrator.
The display shows: “Daisy-Chaining Error: Multiple Ethernet cables Connect only one Ethernet cable”	More than one 12-foot Network Cable (10-pin) has been connected to a phone installation.	Connect only one 12-foot Network Cable (10-pin) to the multiple phone installation. See Installing the Phone on page 1-3.

Power and Startup

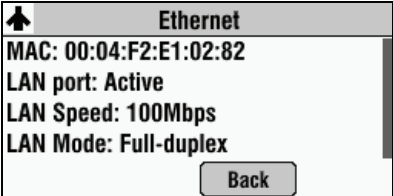
Symptom	Problem	Corrective Action
<p>The display shows: "Network Link is Down"</p>	<p>The network cable is not properly connected.</p>	<p>Verify that the network cable is properly connected:</p> <ul style="list-style-type: none"> • Check the cable termination at the switch or hub (furthest end of the cable from the phone). • Check that the switch or hub is operational (flashing link/status lights). • Press the Menu key, and then select Status > Network > Ethernet. From the Ethernet screen, scroll to LAN port and verify that it is Active.  <ul style="list-style-type: none"> • To attempt re-registration with the call server, reboot the phone. For more information, see your system administrator. • Contact your system administrator.



Controls

Symptom	Problem	Corrective Action
<p>The dial pad does not work.</p>	<p>The dial pad on the phone does not respond.</p>	<p>Do one of the following:</p> <ul style="list-style-type: none"> • Check for a response from other feature keys. • Place a call to the phone from a known working telephone. Check for display updates. • Check if the LAN port is active or inactive. Press the Menu key, and then select Status > Network > Ethernet. From the Ethernet screen, scroll to LAN port and verify that it is Active. <div data-bbox="1019 829 1409 1024" style="border: 1px solid black; padding: 5px; margin: 10px 0;"> <p style="text-align: center;">Ethernet</p> <p>MAC: 00:04:F2:E1:02:82</p> <p>LAN port: Active</p> <p>LAN Speed: 100Mbps</p> <p>LAN Mode: Full-duplex</p> <p style="text-align: right;">Back</p> </div> <ul style="list-style-type: none"> • Check the termination at the switch or hub end of the network LAN cable. Ensure that the switch/hub port is operational (if not accessible, contact your system administrator). • Before restarting your phone, contact your system administrator. Your system administrator may want to troubleshoot the phone in more detail before restarting the phone and losing current status information.

Access to Screens and Systems

Symptom	Problem	Corrective Action
<p>There is no response when you press a feature key.</p>	<p>The phone is not in an active state.</p>	<p>Do one of the following:</p> <ul style="list-style-type: none"> • Press the keys more slowly. • Call the phone to confirm that inbound call display and ringing is normal. If successful, try to press feature keys within the call to access the Directory or Buddy Status screens, for example. • To confirm the line is actively registered to the call server, press the Menu key, and then select Status > Lines > Line Information. From the Line Information screen, verify that your phone line is registered. <div data-bbox="1019 856 1409 1052" style="border: 1px solid black; padding: 5px; margin: 10px 0;"> <p style="text-align: center;">Line Information</p> <p>Line: 1951 (Registered 00:38:42)</p> <p>Server-1: r13as1:0</p> <p style="text-align: center; margin-top: 10px;">Back</p> </div> <ul style="list-style-type: none"> • To attempt re-registration with the call server, reboot the phone. For more information, see your system administrator.
<p>The display shows: "Network Link is Down"</p>	<p>The network cable is not properly connected.</p>	<p>See Power and Startup on page 5-3.</p>



Calling

Symptom	Problem	Corrective Action
There is no dial tone.	Power is not correctly applied to the phone.	<p>Verify that power is correctly applied to the phone:</p> <ul style="list-style-type: none"> • Check that the display is illuminated. • Ensure the network cable is inserted properly on the underside of the phone. (Try unplugging and re-inserting the cable.)
There is no audible ringing.	Ring setting or volume is low.	<p>Verify incoming ring setting and volume level:</p> <ul style="list-style-type: none"> • To adjust the ringer volume, press either  or  when the phone is in the idle state. • Check that the ring type selected is not set to Silent Ring. (For more information, see Updating the Ring Tone on page 2-8.)
	Outbound or inbound calling is unsuccessful.	Place a call to the phone under investigation. Check that the display indicates incoming call information.
<p>A “hollow” phone icon displays at the top left of the screen.</p> 	The phone is not registered to a server.	Ask your system administrator to register the phone to a server.

Displays

Symptom	Problem	Corrective Action
There is no display. The display is incorrect. The display has bad contrast.	Power is not correctly applied to the phone.	Verify that power is correctly applied to the phone: <ul style="list-style-type: none"> • Check that the display is illuminated. • Ensure the network cable is inserted properly on the underside of the phone. (Try unplugging and re-inserting the cable.) • If your phone uses in-line power, have your system administrator check that the switch is supplying power to the phone.
	The contrast needs adjustment.	Adjust the screen contrast. (See Updating the Display Contrast on page 2-6.)
The display is flickering.	Certain types of older fluorescent lighting cause the display to appear to flicker.	Do one of the following: <ul style="list-style-type: none"> • Move the phone away from the lights. • Replace the lights.

Audio

Symptom	Problem	Corrective Action
The speaker has no audible sound.	Speaker volume is low.	Adjust the speaker volume. During a call, press either  or  .

Testing Phone Hardware

Your system administrator may ask you to access a diagnostics menu on your phone to test your phone hardware. From the diagnostics menu, you can test your phone's microphones, keypad mappings, and display. See your system administrator for instructions on how to perform these tests.

To test your phone hardware:

>> Press , and then select **Status > Diagnostics > Test Hardware > Audio Diagnostics, Keypad Diagnostics, or Display Diagnostics.**

Safety Notices

Service Agreements

Please contact your Polycom Authorized Reseller for information about service agreements applicable to your product.

Governing Law

This Limited Warranty and Limitation of Liability shall be governed by the laws of the State of California, U.S.A., and by the laws of the United States, excluding their conflicts of laws principles. The United Nations Convention on Contracts for the International Sale of Goods is hereby excluded in its entirety from application to this Limited Warranty and Limitation of Liability.

All rights reserved under International and Pan-American Copyright Conventions. No part of the contents of this manual may be copied, reproduced, or transmitted in any form or by any means, or translated into another language or format, in whole or part, without written consent from Polycom, Inc. Do not remove (or allow anybody else to remove) any product identification, copyright or other notices.

Limitations of Liability

LIMITATION OF LIABILITY. TO THE FULL EXTENT ALLOWED BY LAW, POLYCOM EXCLUDES FOR ITSELF AND ITS SUPPLIERS ANY LIABILITY, WHETHER BASED IN CONTRACT OR TORT (INCLUDING NEGLIGENCE), FOR INCIDENTAL, CONSEQUENTIAL, INDIRECT, SPECIAL, OR PUNITIVE DAMAGES OF ANY KIND, OR FOR LOSS OF REVENUE OR PROFITS, LOSS OF BUSINESS, LOSS OF INFORMATION OR DATA, OR OTHER FINANCIAL LOSS ARISING OUT OF OR IN CONNECTION WITH THE SALE, INSTALLATION, MAINTENANCE, USE, PERFORMANCE, FAILURE, OR INTERRUPTION OF ITS PRODUCTS, EVEN IF POLYCOM OR ITS AUTHORIZED RESELLER HAS BEEN ADVISED OF THE POSSIBILITY OF SUCH DAMAGES, AND LIMITS ITS LIABILITY TO REPAIR, REPLACEMENT, OR REFUND OF THE PURCHASE PRICE PAID, AT POLYCOM'S OPTION. THIS DISCLAIMER OF LIABILITY FOR DAMAGES WILL NOT BE AFFECTED IF ANY REMEDY PROVIDED HEREIN SHALL FAIL OF ITS ESSENTIAL PURPOSE.

Polycom Limited Warranty and Limitation Liability

LIMITED WARRANTY. Polycom warrants to the end user (“Customer”) that this product is expected to be free from defects in workmanship and materials, under normal use and service, for one year from the date of purchase from Polycom or its authorized reseller.

Polycom’s sole obligation under this express warranty is at Polycom’s option and expense, to repair the defective product or part, deliver to Customer an equivalent product or part to replace the defective item, or if neither of the two foregoing options are reasonably available, Polycom may, on its sole discretion, refund to Customer the purchase price paid for the defective product. All products that are replaced will become the property of Polycom. Replacement products or parts may be new or reconditioned.

Polycom is expected to warrant any replaced or repaired product or part for ninety (90) days from shipment, or the remainder of the initial warranty period, whichever is longer. Products returned to Polycom must be sent prepaid and packaged appropriately for safe shipment, and it is recommended that they be insured or sent by a method that provides for tracking of the package. Responsibility for loss or damage does not transfer to Polycom until the returned item is received by Polycom. The repaired or replaced item will be shipped to Customer, at Polycom’s expense, not later than thirty (30) days after Polycom receives the defective product, and Polycom will retain risk of loss or damage until the item is delivered to Customer.

Exclusions

Polycom will not be liable under this limited warranty if its testing and examination disclose that the alleged defect or malfunction in the product does not exist or results from:

- Failure to follow Polycom’s installation, operation, or maintenance instructions.
- Unauthorized product modification or alteration.
- Unauthorized use of common carrier communication services accessed through the product.
- Abuse, misuse, negligent acts or omissions of Customer and persons under Customer’s control; or
- Acts of third parties, acts of God, accident, fire, lightening, power surges or outages, or other hazards.

Warranty Exclusive

IF A POLYCOM PRODUCT DOES NOT OPERATE AS WARRANTED ABOVE, CUSTOMER’S SOLE REMEDY FOR BREACH OF THAT WARRANTY SHALL BE REPAIR, REPLACEMENT, OR REFUND OF THE PURCHASE PRICE PAID, AT POLYCOM’S OPTION. TO THE FULL EXTENT ALLOWED BY LAW, THE FOREGOING WARRANTIES AND REMEDIES ARE EXCLUSIVE AND ARE IN LIEU OF ALL OTHER WARRANTIES, TERMS, OR CONDITIONS, EXPRESS OR IMPLIED, EITHER IN FACT OR BY OPERATION OF LAW, STATUTORY OR OTHERWISE, INCLUDING WARRANTIES, TERMS, OR CONDITIONS OF MERCHANTABILITY, FITNESS FOR A PARTICULAR PURPOSE, SATISFACTORY QUALITY, CORRESPONDENCE WITH DESCRIPTION, AND NON-INFRINGEMENT, ALL OF WHICH ARE EXPRESSLY DISCLAIMED. POLYCOM NEITHER ASSUMES NOR AUTHORIZES ANY OTHER PERSON TO ASSUME FOR IT ANY OTHER LIABILITY IN CONNECTION WITH THE SALE, INSTALLATION, MAINTENANCE OR USE OF ITS PRODUCTS.

Safety and Compliance

Part 15 FCC Rules

This device is compliant with Part 15 of the FCC Rules. Operation is subject to the following two conditions:

1. This device may not cause harmful interference, and
2. This device must accept any interferences received, including interference that may cause undesired operation.

Class A Digital Device or Peripheral

Note: This equipment has been tested and found to comply with the limits for a Class A digital device, pursuant to part 15 of the FCC Rules. These limits are designed to provide reasonable protection against harmful interference when the equipment is operated in a commercial environment. This equipment generates, uses, and can radiate radio frequency energy and, if not installed and used in accordance with the instruction manual, may cause harmful interference to radio communications. Operation of this equipment in a residential area is likely to cause harmful interference in which case the user will be required to correct the interference at his own expense.

Modifications

In accordance with Part 15 of the FCC Rules, the user is cautioned that any changes or modifications not expressly approved by Polycom, Inc. could void the user's authority to operate the equipment. This equipment may not be used on a coin service or party line.

Installation Instructions

Installation must be performed in accordance with all relevant national wiring rules.

L'Installation doit être exécutée conformément à tous les règlements nationaux applicable au filage électrique.

When using Power over Ethernet (PoE), the equipment is to be connected only to PoE networks without connections to the outside plant.

Plugs Acts as Disconnect Device

The socket outlet to which this apparatus is connected must be installed near the equipment and must always be readily accessible.

La prise électrique à laquelle l'appareil est branché doit être installée près de l'équipement et doit toujours être facilement accessible.

Industry Canada (IC)

This Class [A] digital apparatus complies with Canadian ICES-003.

Cet appareil numérique de la classe [A] est conforme à la norme NMB-003 du Canada.

CE and VCCI Mark

This SoundStation IP 7000 phone is marked with the CE mark. This mark indicates compliance with EC Directives 2006/95/ED and 2004/108/EC. A full copy of the Declaration of Conformity can be obtained from Polycom Ltd., 270 Bath Road, Slough, Berkshire, SL1 4DX, UK.

この装置は、クラスA 情報技術装置です。この装置を家庭環境で使用すると電波妨害を引き起こすことがあります。この場合には使用者が適切な対策を講ずるよう要求されることがあります。 VCCI- A

Safety and Compliance (continued)

사용자 안내문

A 급기기(업무용 정보통신기기)

이 기기는 업무용으로 전자파적합등록을 한 기기이오니 판매자 또는 사용자는 이 점을 주의하시기 바라며 만약 잘못 판매 또는 구입하였을 때에는 가정용으로 교환하시기 바랍니다.

WARNING Electrical Safety

To avoid electric shock, do not connect safety extra low voltage (SELV) circuits to teleconference station network (TNV) circuits. LAN ports contain SELV circuit, and WAN ports contain TNV circuits. Some LAN and WAN ports both use RJ-45 connectors. Use caution when connecting cables.

This product is rated 48Vdc, 0.375A. When used with the optional external power supply, the power supply shall be a Listed power supply with a LPS output, rated 48V, min. 0.375A.

Russian Compliance

Ministry of Information Technologies & Communication of the Russian Federation - Declaration of Conformity DoC # СПД-1918. Expiry 03/28/2011.

Index

Symbols

key, page down shortcut 1-20

* key, page up shortcut 1-20

Numerics

2.5mm audio connector 1-9, 1-10, 2-12

A

AC power 1-4, 1-5, 1-6

AC Power Kit 1-2

accessories, optional

AC Power Kit 1-2

Computer Calling Kit 1-3

console interconnect cable 1-3

External Microphone Kit 1-3

mobile phone cable 1-3

Multi-Interface Module Package 1-3

Video Kit 1-3

analog microphones 1-3

answering calls 3-6, 4-11

appearances, handling 4-19

attended transfer 3-17

audio components 1-9, 2-12

audio connectors 1-9, 1-11, 2-12

Auto Divert setting 2-21

Auto Reject setting 2-21

auxiliary audio components 1-9, 2-12, 4-1

B

backlight intensity 2-6

bass and treble control 2-11

blind transfer 3-17

Block Buddy setting 2-21, 4-23

blocking and unblocking contacts 4-22

buddies, managing 4-20

buddy lists, using 4-20

C

call appearances, handling 4-19

call forwarding 3-19, 4-14

call lists, using 2-14

calls

answering 3-6, 4-11

with auxiliary audio 4-1

and call lists 2-14, 4-11

and conference calls 4-14, 3-9

distinguishing by ring type 2-10, 2-28

diverting 2-29

ending 3-6

forwarding 3-19, 4-14

handling with Polycom HDX system 4-7

holding and resuming 3-8, 3-13, 3-15

holding, and video calls 4-13

ignoring 3-6

obtaining information about 2-17

on-hook and off-hook 3-2

placing 3-2

rejecting 2-28

transferring 2-29, 3-16, 4-13

cell phone, using with video endpoint 4-19

cell phones, using with conference phone 1-9,
1-11, 4-1

characters, entering 1-21

computer

calling applications 1-9, 1-11, 4-1

calling applications, and Polycom HDX system
4-19

calling cable 1-3, 1-9

content, showing 4-18

Computer Calling Kit 1-3, 1-9

conference

calls, hosting 3-9, 4-5, 4-14

key, about 1-17

phone. *See* SoundStation IP 7000

console interconnect cable 1-3, 1-7

consultative transfer 3-16

contact directory, and Polycom HDX system
4-11

- contact directory, managing 2-17
- contact directory, searching for contacts in 2-23
- contacts
 - adding to contact directory 2-19
 - blocking and unblocking 4-22
 - calling 2-27
 - deleting 2-27
 - managing 2-17
 - monitoring 4-21
 - searching for 2-23
 - setting ring tones for 2-9
 - updating 2-26
 - viewing in contact directory 2-18
 - viewing in corporate directory 2-18
- Content soft key 4-18
- content, showing 4-18
- contrast, adjusting for screen 2-6
- corporate directory, and Polycom HDX system 4-11
- corporate directory, managing 2-17
- corporate directory, searching for contacts in 2-23
- customizing your phone 2-1

D

- data, entering 1-20
- date and time display, updating 2-3
- Diagnostics menu 5-7
- dial pad keys, about 1-17
- digital microphones 1-3
- directory contacts, managing 2-17
- display contrast, updating 2-6
- distinguishing calls 2-28
- diverting calls 2-21, 2-29
- Do Not Disturb feature 3-21, 4-14

E

- Encoding soft key 1-21
- end call key, about 1-17
- ending calls 3-6
- EQ settings 2-11
- Extension Microphone Kit 1-3
- extension microphones 1-3
- External Microphone Kit 1-3, 1-8

F

- Far Mute soft key 3-12
- fields, enabling or disabling 1-21
- forwarding calls 3-19, 4-14

H

- hardware, testing 5-7
- HD Voice technology, about 1-18
- HDX
 - microphone cable 1-3, 1-13
 - microphones 1-3
 - system, connecting phone to 1-11
 - system, using with phone 4-7
 - systems, compatible versions 1-11
- holding
 - calls 3-8, 4-13
 - conference call participants 3-13, 4-16
 - conference call participants, from video endpoints 4-17
 - conferences 3-15
 - conferences, from video endpoints 4-17

I

- icons, description of 1-18
- ignoring calls 3-6
- inactivity timer 1-20
- Info soft key 3-12, 3-15
- installation instructions 1-3
- installation issues, troubleshooting 5-2

J

- Join soft key, using 3-11, 4-5

K

- key buttons, description of 1-16

L

- language, updating for phone 2-2
- lapel microphones 1-9, 2-12
- LED indicators 1-15
- lowercase characters, entering 1-21

M

- make call key, about 1-17
- maximum intensity 2-6
- menu key, about 1-17
- menus, navigating 1-20
- microphone cable 1-3, 1-12
- microphones
 - connecting 1-8
 - extension 1-3
 - HDX 1-3
 - internal, about 1-15
 - muting 3-7, 4-17

- Microsoft Office Live Communications Server 2005 4-20, 4-21, 4-25
 - missed calls list 2-14
 - mobile audio, using with video endpoint 4-19
 - mobile phone cable 1-3, 1-9
 - mobile phones, using with conference phone 1-9, 1-11, 4-1
 - Multi-Interface Module 1-3, 1-5, 1-7, 1-10
 - Multi-Interface Module Package 1-3, 1-5, 1-7
 - multiple call appearances, handling 4-18, 4-19
 - Mute key 4-17
 - mute key, about 1-17
 - muting the microphone 3-7, 4-6
 - MyStat soft key 4-20
- N**
- Name soft key 3-4
 - network cable 1-3, 1-5, 1-7
 - network, connecting to phone 1-3
 - numbers, entering 1-21
- O**
- off-hook calls 3-2
 - on-hook calls 3-2
 - optional accessories
 - AC Power Kit 1-2, 1-4
 - Computer Calling Kit 1-3, 1-9
 - console interconnect cable 1-3, 1-7
 - External Microphone Kit 1-3, 1-8
 - mobile phone cable 1-3, 1-9
 - Multi-Interface Module Package 1-3, 1-5, 1-7
 - Video Kit 1-3
- P**
- parts list 1-2
 - phone, using with Polycom HDX system 4-7
 - placed calls lists 2-14
 - placing calls 3-2, 4-9
 - PoE 1-3
 - Polycom HD Voice technology, about 1-18
 - Polycom HDX microphone cable 1-3, 1-12
 - Polycom HDX system, connecting to phone 1-11
 - Polycom HDX system, using with phone 4-7
 - Polycom HDX systems, compatible versions to run with phone 1-11
 - power adapter 1-2, 1-3, 1-5
 - Power Insertion Cable 1-2, 1-4
 - power issues, troubleshooting 5-3
 - Power over Ethernet 1-3
 - power source, connecting to phone 1-3
 - presence settings 4-20
- R**
- received calls list 2-14
 - recording devices 1-9, 2-12
 - redial key, about 1-17
 - redialing numbers 3-7
 - regional power cord 1-2, 1-3
 - registering the phone 1-14
 - Reject soft key 2-28, 3-6
 - rejecting calls 2-28, 3-6, 4-14
 - restarting the phone 4-26
 - Retain Search feature 2-24
 - ring tone, updating for contacts 2-8
 - ringer volume, adjusting 2-14
- S**
- scroll keys, about 1-16, 1-20
 - searching for contacts 2-23
 - select key, about 1-17
 - shared lines 2-30
 - showing content 4-18
 - Silence feature 3-6
 - soft keys, about 1-16
 - soft keys, viewing 1-21
 - SoundStation IP 7000
 - accessories (optional) for 1-2
 - advanced features of 4-1
 - auxiliary audio components, connecting to 1-9
 - extended microphones 1-3
 - hardware, testing 5-7
 - installing 1-3
 - language support for 2-2
 - registering 1-14
 - restarting 4-26
 - troubleshooting 5-1
 - video, integrating with 1-11
 - spaces, entering 1-21
 - speaker, internal 1-15
 - speaker, volume, adjusting 2-14, 4-6
 - speakers, external 1-9, 2-11, 2-12
 - special characters, entering 1-21
 - speed dialing 3-5, 3-23, 4-11
 - startup issues, troubleshooting 5-3
 - status, updating 4-20
 - symbols, entering 1-21

T

- testing phone hardware 5-7
- text, entering and deleting 1-20, 1-21
- time and date display, updating 2-3
- transferring calls 2-29, 3-16, 4-13
- treble and bass control, updating 2-11
- troubleshooting
 - audio problems 5-7
 - calling problems 5-6
 - control problems 5-4
 - and the Diagnostics menu 5-7
 - display problems 5-7
 - hardware 5-7
 - installation problems 5-2
 - power and startup problems 5-3
 - screen and system problems 5-5

U

- uppercase characters, entering 1-21
- URLs, dialing 3-4

V

- video components, connecting to phone 1-11
- Video Kit 1-3
- video, integrating with phone 1-11
- voice mail 2-28, 3-24
- volume keys, about 1-17
- volume, adjusting 2-14, 4-6, 4-17

W

- Watch Buddy setting 2-21, 4-22
- watcher list 4-22
- wireless microphones 1-9, 2-12