



HIDRACAR S.A.



WE DESIGN AND MANUFACTURE:...



**Bladder,
Membrane & Bellows
Pulsation Dampers
(all dismantable units)**



**Piston
Accumulators**



**Oleo-pneumatic Suspensions
for Vehicles with a High Relation
Loaded / Unloaded**

**Oleo-hydraulic Starters
for Diesel Engines**



Shock Absorbers



HIDRACAR S.A.

since 1974

CNC lathe with robotized loading

**EXPERIENCE,
TECHNOLOGY
AND SERVICE ...**



Plasma & MAG welding robot



Rubber bladder vulcanizing presses

... AT YOUR DISPOSITION

HIDRACAR, S.A.
Pol. Ind. Les Vives - c/ Anaïs Nin, 14
08295 Sant Vicenç de Castellet, Barcelona (SPAIN)
www.hidracar.com E-mail: hidracar@hidracar.com
Tel.: +34 93 833 02 52 Fax: +34 93 833 19 50



HIDRACAR S.A.

WHEN YOU BUY A
HIDRACAR
ACCUMULATOR OR PULSATION DAMPENER, YOU GET:

- **More than 35 years of experience in designing, manufacturing and applying hydro-pneumatic accumulators.**
- **A pressure apparatus that meets the CE regulations.**
- **The machining precision of CNC lathes.**
- **Safety:**
 - ◆ *All our accumulators undergo hydraulic tests at 1.5 times its maximum design pressure.*
 - ◆ *Civil liability insurance coverage (FIATC Cia. de Seguros).*
- **Quality control:**
 - ◆ *We have the ISO 9001 certification.*
 - ◆ *Computerised manufacturing registry control that makes possible to identify every single accumulator manufactured by us since 1976.*
 - ◆ *The charging gas valve keeps its seal up to 700 bar.*

With all the features shown above, do you still have any doubt? If so, please, contact us, we will clarify any data or give you any extra information you could need.

We remain waiting for your enquiries.

Certificate

Standard **ISO 9001:2008**

Certificate Registr. No. 0.04.07074

TÜV Rheinland Ibérica Inspection, Certification & Testing S.A. certifies:

Certificate Owner: **HIDRACAR, S.A.**
Pol. Ind. "Les Vives", s/n
E-08295 Sant Vicenç de Castellet (Barcelona)

Scope: Design and Manufacture of Hydropneumatic Accumulators, Pulsation Dampers, Dynamometers, Shock Absorbers, Oleohydraulic Starters and Suspension Cylinders.

An audit was performed, Report No. 07074. Proof has been furnished that the requirements according to ISO 9001:2008 are fulfilled.

The due date for all future audits is 28-09 (dd-mm).

Validity: The certificate is valid from 2010-12-28 until 2013-12-27.
First certification 2007-12-28.

2011-01-12 TÜV Rheinland Ibérica Inspection, Certification & Testing S.A.
Garrotxa, 10-12 - E-08920 El Prat de Llobregat



HIDRACAR S.A.

HIDRACAR ACCUMULATOR REFERENCE CODE IDENTIFICATION

This is the standard *HIDRACAR S.A.* accumulator reference code layout (without colour; here only for code section identification purposes):

X # # # X # # X # - X X X X / X X

- ◆ The first letter (X) indicates the type of accumulator:

U for bladder **M** for membrane **F** for bellows **P** for piston

- ◆ The following three digits (###) identify the volume of the accumulator

001	0.07 litres	007	0.65 litres	030	2.60 litres	100	9.50 litres
002	0.15 litres	010	0.95 litres	040	3.70 litres	150	15.0 litres
003	0.35 litres	015	1.40 litres	060	5.60 litres	350	35.0 litres

- ◆ The second letter (X) refers to the type of gas charging valve:

A for a 1/4" BSP valve **B** for a Vg8 valve

- ◆ The second set of two digits (##) refers to the design pressure of the accumulator (number to be multiplied by 10 to give the actual pressure in bar units):

Examples:

02 (0)2 x 10 = 20 bar **18** 18 x 10 = 180 bar **41** 41 x 10 = 410 bar

- ◆ The third letter (X) identifies the material of the separator element between the charging gas (N₂ or air) and the liquid in the circuit:

N	Nitrile rubber	E	EPDM rubber	V	FPM rubber
B	Butyl rubber	S	Silicone rubber	G	Hydrogenated Nitrile rubber
T	TFM & PTFE	F	FPM (70% Fluorine)	I	Stainless steel
R	Low temperature Nitrile rubber			C	Neoprene rubber

- ◆ Followed by a last digit (#) which refers to the number of connecting ports (see the standard thread size available on each technical note; these are referenced at the very end of the code as such if different from our standard thread size):

1 One connection port **2** Two connection ports

Special case (§): In carbon steel body accumulators, a 0 digit follows after the 1 or 2 digit, if the specific material code is not included.

◆ Finally, the last set of two to four letters (XXXX) (or its absence) identifies the raw material of the accumulator body and bladder or membrane inserts:

AI AISI 316L Stainless steel	PP Polypropylene	PC PVC	PCC Chlorinated PVC	
PD PVDF	DU Duplex	SDU Super Duplex	HAST Hastelloy	TI Titanium
ALLY Special alloy	AC Carbon steel	(NO LETTERS) Carbon steel (§)		
SA Carbon steel – internal nickel coating accumulator for water service				

◆ In some instances an extra codification for one or more special characteristics is added, separated by a slash after the basic part of the reference code:

E General reference for special manufacture; becoming obsolete due to its inherent lack of specificity			
DR Quick dismantling design	IN Indicator rod attachment	CR Reinforcing jacket	
PD PVDF connecting port	TF PTFE connecting port	TFG Graphite-PTFE connecting port	
HC Hastelloy connecting port	CC Heating jacket	NS Apparatus without welded seams	
IC Internal HALAR® coating	BA Additional cylinder connection	(90°) Connection port at 90°	
(LINIA) In-line accumulator			

Let's see an overall example:

F007A1111-AI/CC
F007A1111-AI/CC

F	Bellows type	007	0.65 litres volume
A	fitted with a ¼" BSP valve	11	110 bar design pressure
I	Stainless steel bellows	1	One connection port
AI	Stainless steel body	CC	Heating jacket

So this reference corresponds to a stainless steel, bellows type, accumulator with an internal volume of 0,65 litres, designed for working at a pressure of 110 bar, fitted with a stainless steel bellows, one standard connection port, a ¼" BSP gas charging valve and a heating jacket.

3rd Rev., June 2012



HIDRACAR S.A.

Design, quality and experience since 1974

"We make liquids flow smoothly through pipes"

BLADDER, MEMBRANE & BELLOWS

PULSATION DAMPENERS

**TO STABILIZE THE FLOW AND PRESSURE
IN CIRCUITS WITH VOLUMETRIC PUMPS**

- ✓ ALLOW PUMPS TO WORK WITHOUT SHOCKS, INCREASING ITS LIFE AND THE LIFE OF FILTERS, FLOWMETERS AND OTHER ACCESSORIES
- ✓ GIVE MORE ACCURACY TO PRESSURE GAUGES AND FLOWMETERS
- ✓ PREVENT LEAKAGE IN PIPE CONNECTIONS, CREATED BY PRESSURE PEAKS

**SIZES RANGE FROM 0.075 TO 35 LITRES
AND WORKING PRESSURES UP TO 800 bar**

MATERIALS:

BODY: AISI 316L, POLYPROPYLENE, PVC, PVDF & OTHERS
SEPARATOR: NITRILE, EPDM, FPM, SILICONE, PTFE, STAINLESS STEEL & OTHERS

STANDARD
PLASTIC
DAMPENER
WITH BLADDER



VERY HIGH
TEMPERATURE
DAMPENER WITH
STAINLESS STEEL
BELLOWS



PTFE
BELLOWS
DAMPENER
FOR CORROSIVE
LIQUIDS



TWO PORT
CONNECTION
BLADDER
DAMPENER



PTFE
MEMBRANE
DAMPENER
WITH ROD
INDICATOR
AND ANSI
FLANGE



TWO PORT CONNECTION
BLADDER DAMPENER
FOR FOOD
APPLICATIONS

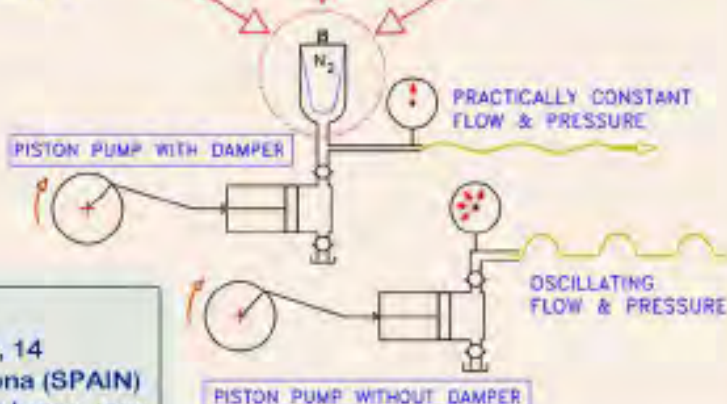

HIDRACAR, S.A.

Pol. Ind. Les Vives - c/ Anais Nin, 14

08295 Sant Vicenç de Castellet, Barcelona (SPAIN)

www.hidracar.com E-mail: hidracar@hidracar.com

Tel.: +34 93 833 02 52 Fax: +34 93 833 19 50

FLOW GRAPHICS OF DIFFERENT PISTON PUMPS SHOWING THE LIQUID VOLUME AND FLOW ACROSS THE PULSATION DAMPER

T = time employed by the crankshaft when turning one revolution (ex. 0.4 sec.=150 r.p.m.)

C = capacity of the piston head (ex. 509 c.c. for the three pump types)

δ = theoretically the amount of liquid going in and out of the dampener in each cycle

M.I.F. = max. instantaneous flow

M.F. = mean flow

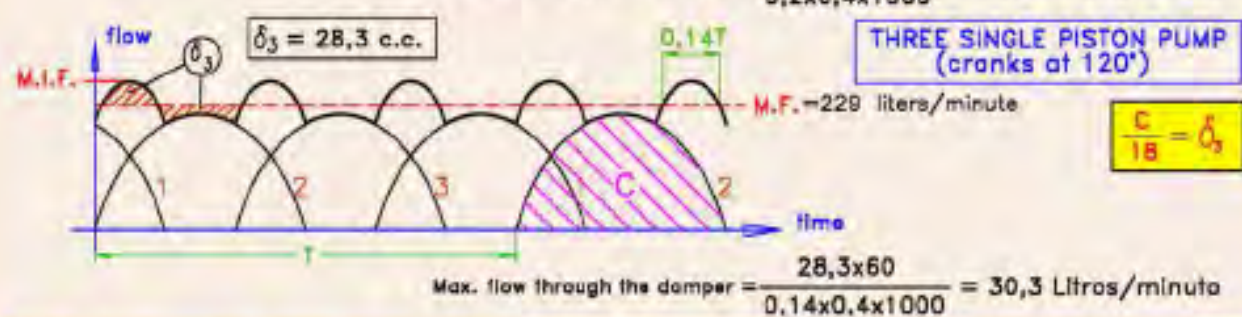
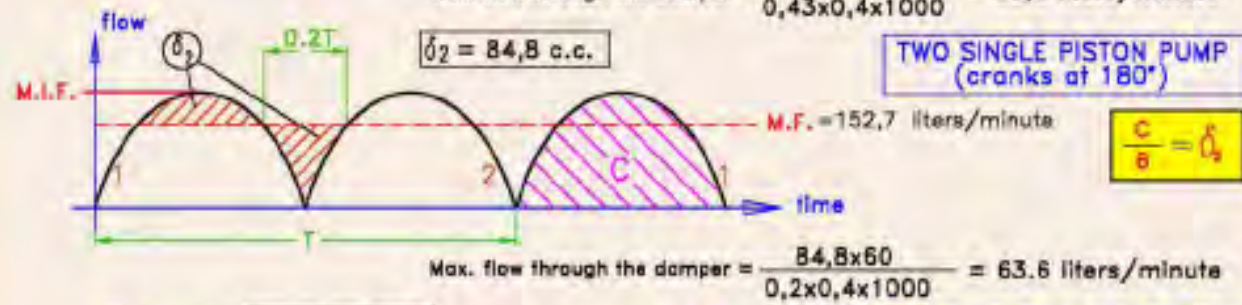
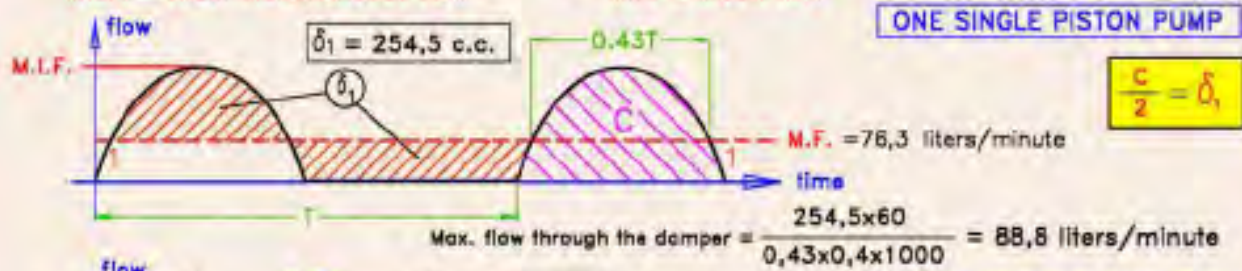

EASY DAMPER SIZE SELECTION ACCORDING TO THE PUMP (*) CAPACITY PER REVOLUTION, AND % OF RESIDUAL PULSATION ADMITTED

DAMPER TYPES REF.			DAMPERS VOLUME (litres)			1 PISTON PUMP 2 PISTONS PUMP 3 PISTONS PUMP					
						% (+,-) OF RESIDUAL PULSATION ADMITTED					
						±3%	±6%	±3%	±6%	±3%	±6%
						(*) PUMP CAPACITY PER REVOLUTION					
BLADDER	MEMBRANE	BELLOWS	BLAD.	MEMB.	BELL.	6cc	12cc	16cc	32cc	50cc	100cc
U001			0,075			12 "	24 "	35 "	70 "	105 "	210 "
U002	M002	F002	0,15	0,2	0,15	24 "	48 "	70 "	140 "	210 "	420 "
U003	M004	F003	0,35	0,4	0,3	50 "	100 "	155 "	310 "	465 "	930 "
U007	M008	F007	0,65	0,8	0,7	75 "	150 "	230 "	460 "	675 "	1350 "
U010			0,95			95 "	190 "	310 "	620 "	900 "	1800 "
U015	M012	F015	1,4	1,3	1,4	210 "	420 "	615 "	1230 "	1850 "	3700 "
U030	M030	F030	2,6	2,7	2,6	290 "	580 "	875 "	1750 "	2650 "	5300 "
U040	M040	F040	3,7	3,9	3,7	405 "	810 "	1200 "	2400 "	3650 "	7300 "
U060	M060	F050	5,6	5,1	5,6	750 "	1500 "	2270 "	4540 "	6900 "	13800 "
U100	M100	F090	9,5	10	10	1195 "	2390 "	3600 "	7200 "	10950 "	21900 "
U150	M150	F150	15	15	15	2800 "	5600 "	8425 "	16850 "	25000 "	50000 "
U350			35								

NOTE: THE TABLE VALUES ARE APPROXIMATE AND CORRESPOND TO A CONSTANT TEMPERATURE OF THE LIQUID AND ENVIRONMENT

(L/h = litres/hour) FORMULA TO OBTAIN THE PUMP CAPACITY PER REVOLUTION $\frac{\text{FLOW (L/h)}}{60 \times \text{s.p.m.}}$
 (s.p.m. = strokes per minute) crankshaft revolutions per minute

OTHER PRODUCTS WE MANUFACTURE: OLEOPNEUMATIC SHOCK ABSORBERS, OLEOHYDRAULIC TENSIONERS, OLEOHYDRAULIC STARTERS FOR EMERGENCY MARINE DIESEL ENGINES, OLEOPNEUMATIC SUSPENSIONS FOR VEHICLES WITH HEAVY LOADS

AUTO 2012 / B-DOS / PUBLIPULSANTES-ING / REV15 (2012)

Rev 15

WE CAN CHANGE THE DATA WITHOUT PREVIOUS NOTICE

ORDER EXAMPLE: U007 A01 V 1 PP
 Capacity: 0,65 litre
 A01=10bar
 V= FPM Rubber Bladder
 3/4" Standard Connection
 Body & Insert material: Polypropylene

MINIMUM SAFETY FACTOR: 4:1

FOR HIGHER PRESSURES, SIZES, MATERIALS AND THREAD CONNECTIONS, PLEASE CONSULT

Value of "K": $\frac{\text{Maxi. Pressure}}{\text{Filling gas Pressure}} \times K$ (@Constant Temp.)

Well thickness acc. to AD-2000 code

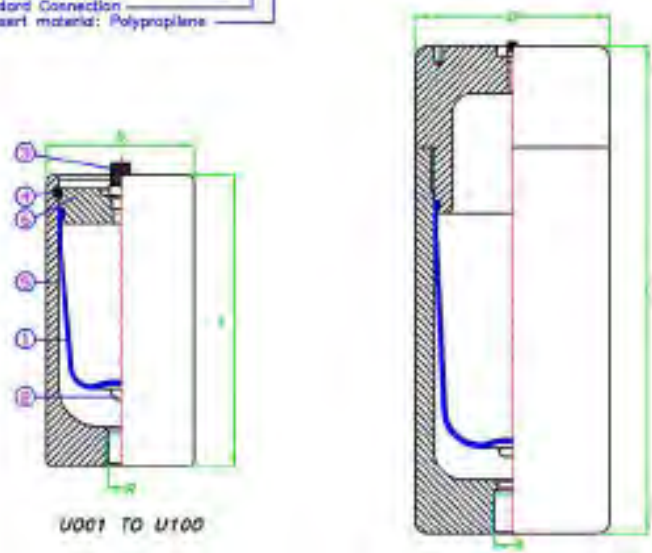

PULSATION DAMPER REF.	VOLUME (litres)	D (mm)	L (mm)	R (BSP)	WEIGHT (Kg)		K VALUE
					PC & PD	PP	
U001	0.07	60	98	3/8"	0,35	0,25	2,5
U002	0.15	80	135	1/2"	0,7	0,5	
U003	0.35	90	170	3/4"	1,2	0,8	3
U007	0.65	100	230		1,8	1,2	3,5
U010	0.95	130	245	1"	3	2	3
U015	1.40		295		3,5	2,4	3,5
U030	2.60	160	325	1"	5	3,5	5
U040	3.70		422		5,8	4	
U060	5.60	198	458	1 1/2"	13	9	5
U100	9.50	250	500	2"	20,4	14	4
U150	15		672		23,3	17	2,5
U200	20	250	880	2"	27,7	21	3

PP=POLYPROPYLENE
 (+) PD= PVDF
 PC= PVC

Standard Bladder Rubbers: N=NITRILE, E=EPDM, V=FPW
 (Other Rubbers: Butyl, Hypalon, HNBR, etc.)

	N	E	V
Rubbers Max. Working Temperatures (°C)	50	-5	-5

THE MAXI TEMPERATURE CAN BE REDUCED DEPENDING ON THE LIQUID IN CONTACT

TO ORDER: External dimensions: ± 2% Volume: ± 2.5% Weight: ± 3%

6	COVER	1	(+) PP, PD or PC
5	BODY	1	(+) PP, PD or PC
4	RETAINING RING	1	(+) PP, PD or PC
3	INFLATING (AIR OR N2) VALVE	1	AISI 316L 1/4" BSP
2	INSERT (BUTTON)	1	(+) PP, PD or PC
1	BLADDER	1	NBR, EPDM & FPM
N*	DENOMINATION	QT.	MATERIALS

NOTE: The precharge with gas or air must be done slowly and with our charging tool Ref. BV010A1TM

Those Pulsation Dampers ought to be filled with gas at a value of 0.80x the pressure to stabilize and that at the working temperature

HIDRACAR SA
 08295 S.VIE. CASTELLET
 (BARCELONA) SPAIN
 TEL.34.93.8330252 FAX.34.93.8331950

Customer: Title: PLASTIC PULSATION DAMPERS (standard units)

Customer Ref: Replaced Drg.N°: AV.PL.BP.IN.DOC(Rev.9)

Drawn: E.Ponso Approved: M.Carcaré

Revised: 10 Date: Jan-13 Scale: none

ORDER EXAMPLE: U030 A03 V 1 AI
 Capacity: 2,6 litres
 A03=30bar
 V= FPM Rubber Bladder
 1" Standard Connection
 Body & Insert material AISI 316L

FOR HIGHER PRESSURES, SIZES, MATERIALS AND THREAD CONNECTIONS, PLEASE CONSULT

Value of "K": $\frac{\text{Maxi. Pressure}}{\text{Filling gas Pressure}} \times K$ (@Constant Temp.)

Well thickness acc. to AD-2000 code

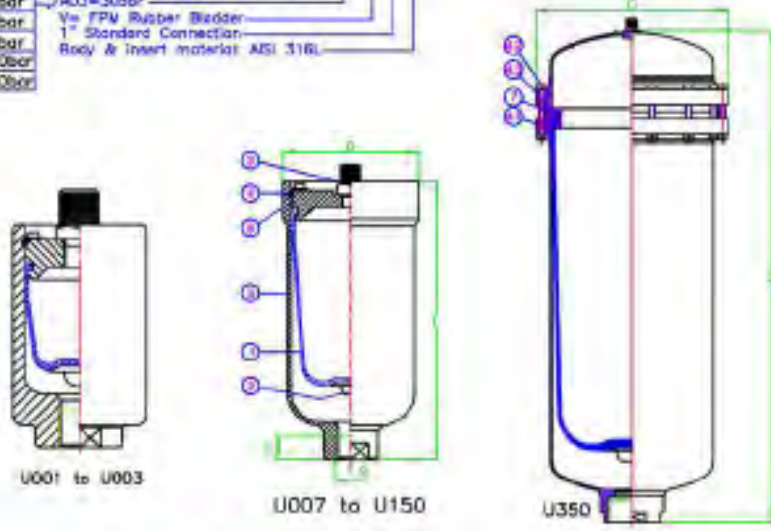

PULSATION DAMPER REF.	VOLUME (litres)	DESIGN PRESSURE (bar-g @30°C)	D (mm)	L (mm)	R (BSP)	H (mm)	WEIGHT (Kg)		K VALUE
							PC & PD	PP	
U001	0.07	200	55	93	3/8"	14	0,9	1,8	2,5
U002	0.15	180	70	118	1/2"	16	3,6	3	3
U003	0.35		85	161		2,5	3,5		
U007	0.65	50	90	205	3/4"	20	4,3	3	3,5
U010	0.95	40	110	200		245	25	4,6	
U015	1.4		30	140	295	390	27	5,3	5
U030	2.6	40		170	414	1 1/2"	10	14,5	4
U040	3.7		30	220	625	2"	30	18,5	5
U060	5.6	40		170	414	1 1/2"	10	28,5	4
U100	9.5	30	220	442	2"	30	14,5	4	5
U150	15		625	18,5			5		
U350	35	20	302	797	2 1/2"		28,5	4	

H = MAXI LENGTH OF THREAD CONNECTION

Standard Bladder Rubbers: N=NITRILE, E=EPDM, V=FPW
 (Other Rubbers: Butyl, Hypalon, HNBR, etc.)

	N	E	V
Rubbers Max. Working Temperatures (°C)	+80 -15	+130 -30	+170 -15

Working Temperatures versus Working Pressures **
 For a temperature of 80°C correspond design pressure x 0.87
 " " " 130°C " " " x 0.78
 " " " 170°C " " " x 0.72

THE MAXI TEMPERATURE CAN BE REDUCED DEPENDING ON THE LIQUID IN CONTACT

TO ORDER: External dimensions: ± 2% Volume: ± 2.5% Weight: ± 3%

7	O' RING	1	Nitrile, EPDM & FPM
6	COVER	1	AISI 316L
5	BODY	1	AISI 316L
4,3	RETAINING RING	1	St-52Elec. Nikel plat.
4,2	BOLTS & NUTS	14	DIN 912 & 934 A4-70
4,1	RETAINING RING	2	St-52Elec. Nikel plat.
4	RETAINING RING	1	DIN17224 (AISI 316L)
3	INFLATING N2 VALVE	1	AISI 316L (1/4" BSP)
2	INSERT	1	AISI 316L
1	BLADDER	1	Nitrile, EPDM & FPM
No	DENOMINATION	QT.	MATERIALS

NOTE: The precharge with gas or air must be done slowly and with our charging tool Ref. BV160A1TM

Those Pulsation Dampers ought to be filled with gas at a value of 0.80x the pressure to stabilize and that at the working temperature

HIDRACAR SA
 08295 S.VIE. CASTELLET
 (BARCELONA) SPAIN
 TEL.34.93.8330252 FAX.34.93.8331950

Customer: Title: S.S.MEDIUM & LOW PRESSURE BLADDER PULSATION DAMPERS (standard units)

Customer Ref: Replaced Drg.N°: AV.AI.MP-BP.IN.DOC(Rev.13)

Drawn: E.Ponso Approved: M.Carcaré

Revised: 14 Date: Jan-13 Scale: none

FOR HIGHER PRESSURES, SIZES, MATERIALS AND THREAD CONNECTIONS, PLEASE CONSULT

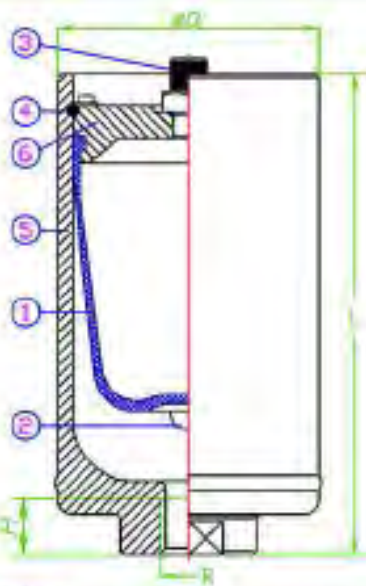

ORDER EXAMPLE: U003 A18 Y 1 M
 Capacity: 0.35 litres
 A18=180bar
 Y=TFM Rubber Bladder
 M=1/2" Standard Connection
 Body & insert material: AISI 316L

Value of "K": $\frac{\text{Maxi. Pressure}}{\text{Filling gas Pressure}} \times K$ (@Constant Temp.)

PULSATION DAMPER REF.	VOLUME (litres)	DESIGN PRESSURE (bar-g)	D (mm)	L (mm)	R (BSP)	H (mm)	WEIGHT (Kg)	K VALUE
U001	0.07	200	55	93	3/8"	14	0.9	2.5
U002	0.15	180	70	118	1/2"	16	1.8	3
U003	0.35		85	161			3.6	
U007	0.65	120	90	205	3/4"	20	3.8	3.5
U010	0.95	110	112	200			6.0	
U015	1.40		245	25	6.8			
U030	2.60	140	295	1"	27	10.5	5	
U040	3.70		386	12.2				
U060	5.60	130	170	414	1 1/2"	35	24.0	
U100	9.5		442	46.0				
U150	15.0	625	52.5					
U180	18.0	760	56.0					

TOLERANCES:
 External dimensions: ± 0.1
 Volume: ± 2.5% Weight: ± 5%

6	COVER	1	AISI 316L
5	BODY	1	AISI 316L
4	RETAINING RING	1	DIN17224 (AISI 316L)
3	INFLATING N ₂ VALVE	1	AISI 316L (1/4" BSP)
2	INSERT	1	AISI 316L
1	BLADDER	1	Nitrile, EPDM & FPM
Nº	DENOMINATION	QT.	MATERIALS

Standard Bladder Rubbers: N=NITRILE, E=EPDM, Y=FPM
 (Other Rubbers: Butyl, Hypalon, HMBR, etc.)
 Rubbers Max. Working Temperatures (°C)
 N: +80 -15
 E: +130 -30
 Y: +170 -15
 Working Temperatures versus Working Pressures **
 For a temperature of 80°C correspond design pressure x 0.87
 " " " 130°C " " " x 0.78
 " " " 170°C " " " x 0.72

THE MAXI TEMPERATURE CAN BE REDUCED DEPENDING ON THE LIQUID IN CONTACT
 Those Pulsation Dampeners ought to be filled with gas at a value of 0.80x the pressure to stabilize and that at the working temperature

NOTE: The precharge with gas or air must be done slowly and with our charging tool Ref. BV160A1TM
 ATTENTION! ALWAYS MUST BE MOUNTED VERTICALLY (VALVE 3 ON TOP)

 HIDRACAR SA 08295 S.VTE. CASTELLET (BARCELONA) SPAIN TEL.34.93.8330252 FAX.34.93.8331950	Customer	Customer Ref.	Replaced Drg.Nº	Drawn	Approved
	Title: S.S.MEDIUM PRESSURE BLADDER PULSATION DAMPERS (standard units)		Urg.No	Rev.	Date
			AV.AI.MP.IN.DOC (Rev.12)	E.Ponsa	M.Carcare
			AV.AI.MP.IN.DOC	13	Jan-13 none

ORDER EXAMPLE: M030 A03 T 1 M
 Capacity: 2.8 litres
 A03=30bar
 T=TFM1705 MEMBRANE
 M=1-1/2" Standard Connection
 Body & insert material: AISI 316L

FOR HIGHER PRESSURES, SIZES, MATERIALS AND THREAD CONNECTIONS, PLEASE CONSULT

Value of "K": $\frac{\text{Maxi. Pressure}}{\text{Filling gas Pressure}} \times 2$ (@Constant Temp.)

⊕ In these models the value of "K" = 1.5 (@ Constant Temp.)

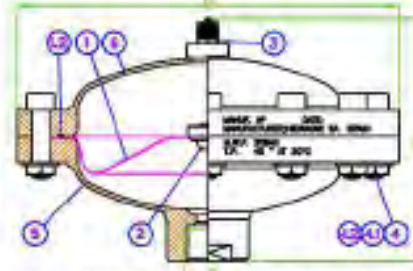
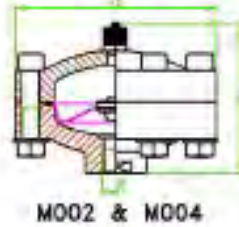
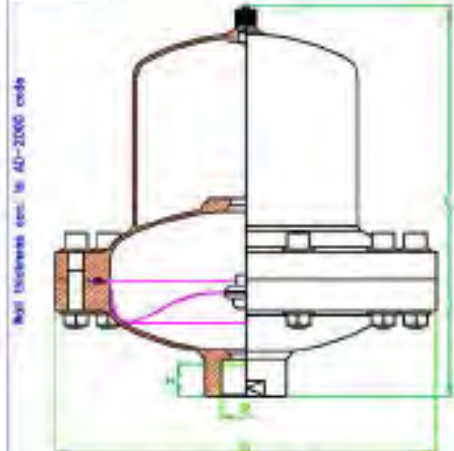

PULSATION DAMPER MODEL	VOLUME (litres)	DESIGN PRESSURE (bar-g)	D (mm)	L (mm)	R (BSP)	H (mm)	WEIGHT (Kg)
M002	0.2	200	140	100	1/2"	14	5.2
M004	0.4	100	164	122	3/4"	20	9.2
M008	0.8	50	180	150			3
M012	1.2	40	224	160	1-1/2"	30	7.5
M030	2.8	30	289	180			15.5
⊕M040	4	20	340	275	2"	30	17
M060	5.6			233			24.5
⊕M100	10			398			26

TOLERANCES:
 External dimensions: ± 0.1
 Volume: ± 2.5% Weight: ± 5%

6	UPPER SHELL	1	AISI 316L
5	LOWER SHELL	1	AISI 316L
4.2	NUT	1/2	DIN 934 A4-70
4.1	GASKET	1/2	DIN 125 A4-70
4	BOLTS	1/2	DIN 912 A4-70
3	FILLING N ₂ VALVE	1	AISI 316L (1/4" BSP)
2	INSERT (button)	1	AISI 316L
1.2	"O" RING	1	SILICONE
1	MEMBRANE	1	PTFE (TFM1705)
Nº	DENOMINATION	QT.	MATERIALS

TEMPERATURES RANGE: -40° to +200°C
 Working Temperatures versus Working Pressures
 For a temperature of 100°C correspond design pressure x 0.82
 " " " 150°C " " " x 0.75
 " " " 200°C " " " x 0.68

THE MAXI TEMPERATURE CAN BE REDUCED DEPENDING ON THE LIQUID IN CONTACT
 Those Pulsation Dampeners ought to be filled with gas at a value of 0.80x the pressure to stabilize and that at the working temperature

NOTE: The precharge with gas or air must be done slowly and with our charging tool Ref. BV160A1TM
 ATTENTION! ALWAYS MUST BE MOUNTED VERTICALLY (VALVE 3 ON TOP)

 HIDRACAR SA 08295 S.VTE. CASTELLET (BARCELONA) SPAIN TEL.34.93.8330252 FAX.34.93.8331950	Customer	Customer Ref.	Replaced Drg.Nº	Drawn	Approved
	Title: S.S.PULSATION DAMPER MEMBRANE		Urg.No	Rev.	Date
			AM.AI.BP.IN.DOC (Rev.16)	E.Ponsa	M.Carcare
			AM.AI.BP.IN.DOC	17	Jan-13 none

ORDER EXAMPLE: F030 A04 T 1 A
 Capacity: 2,6 litres
 A04=40bar
 T= PTFE Bellows
 1" Standard Connection
 Body & Insert material: AISI 316L

Maxi. Pressure = 2 (@Constant Temp.)
 Filling gas Pressure = 2 (@Constant Temp.)

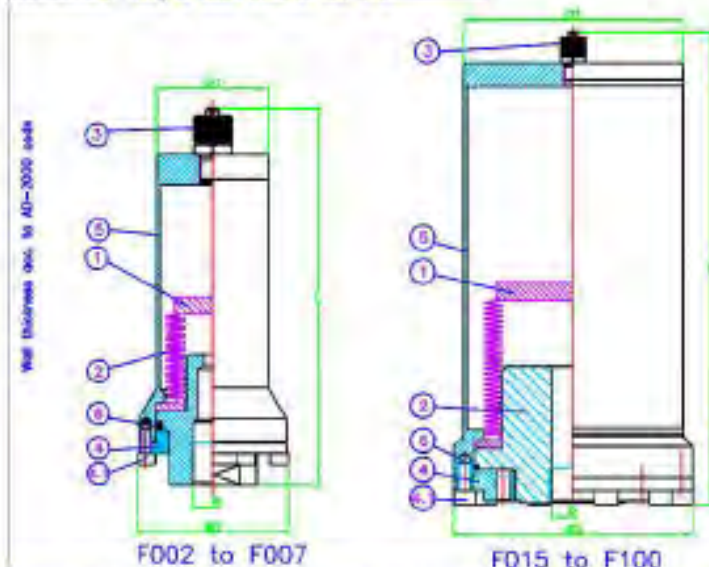

PULSATION DAMPER MODEL	MAXI. ΔV ADMITTED (c.c.)**	VOLUME (litres)	DESIGN PRESSURE (bar-g)	D (mm)	D1 (mm)	L (mm)	R (BSP)	WEIGHT (kg.)
F002	15	0.15	60	70	53	178	1/2"	1.8
F003	45	0.3	50	84	64	234	1/2"	2.6
F007	120	0.7	50	105	84	250	3/4"	3
F015	250	1.4	40	123	104	276	3/4"	7.5
F030		2.6	40			306		12
F040	600	3,7	40	170	156	368	1"	12.5
F060		5,6	40			475		13.5
F100	1500	10	30	250	206	441	2"	24

TOLERANCES:
 External dimensions: ± 0,05
 Volume: ± 2,5% Height: ± 0,5%

6	SEAL GASKET	1	SILICONE
5	BODY	1	AISI 316L
4,1	BOLTS	7	DIN 912 A4-70
4	RETAINING NUT	1	AISI 304
3	FILLING VALVE	1	AISI 316L (1/4" BSP)
2	NOZZLE	1	AISI 316L
1	BELLOWS	1	PTFE
N°	DENOMINATION	QT.	MATERIALS

ATTENTION! ALWAYS MUST BE MOUNTED VERTICALLY (VALVE 3 ON TOP)

Working Temperatures versus Working Pressures.
 For a temperature of 100°C correspond design pressure x 0.82
 150°C x 0.75

WORKING LIMITS TEMPERATURES(°C): -40° / +150°C

** ΔV=C/2 for a single head pump (°C=Head pump volume)
 ΔV=C/6 for a duplex heads pump
 ΔV=C/18 for a three heads pump

THE MAXI TEMPERATURE CAN BE REDUCED DEPENDING ON THE LIQUID IN CONTACT

Those Pulsation Dampeners ought to be filled with gas at a value of 0.80x the pressure to stabilize and that at the working temperature

NOTE: The precharge with gas or air must be done slowly and with the adequate tool BV060A1TM

HIDRACAR SA
 08295 S.VTE. CASTELLET
 (BARCELONA) SPAIN
 TEL.34.93.8330252 FAX.34.93.8331950

Customer:	Customer Ref.	Replaced Drg.N°	Drawn:	Approved:
		AFT.AI.BP.IN.DOC (Rev.12)	E.Pansa	M.Caroar6
Title:	PULSATION DAMPER WITH PTFE BELLOWS, SS BODY	Drg.No	Rev.	Date
		AFT.AI.BP.IN.DOC	13	Jan-13

ORDER EXAMPLE: F030 A02 T 1 N/P3
 Capacity: 2,6 litres
 A02=20bar
 T= PTFE Bellows
 1" Standard Connection
 Body material: AISI 316L
 Nozzle material: PVDF

Maxi. Pressure = 2 (@Constant Temp.)
 Filling gas Pressure = 2 (@Constant Temp.)

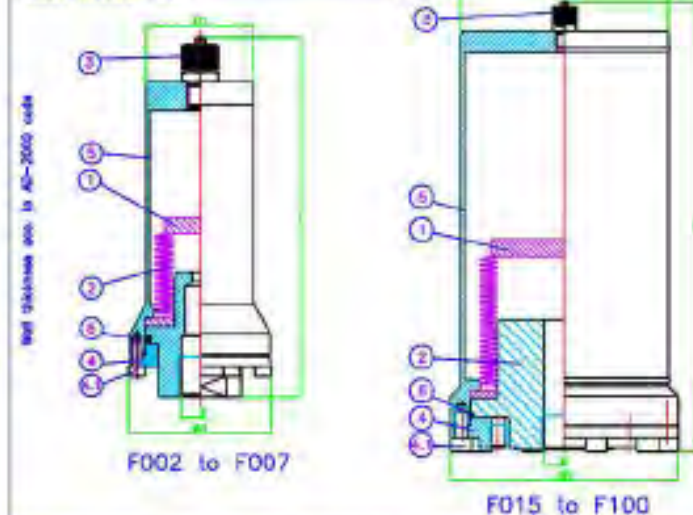

PULSATION DAMPER MODEL	MAXI. ΔV ADMITTED (c.c.)**	VOLUME (litres)	D (mm)	D1 (mm)	L (mm)	R (BSP)	WEIGHT (kg.)
F002	15	0.15	70	53	178	1/2"	1.8
F003	45	0.3	84	64	234	1/2"	2.2
F007	120	0.7	105	84	250		2.7
F015	250	1.4	123	104	276	3/4"	7.1
F030		2.6			306		11.5
F040	600	3,7	170	156	368	1"	12.1
F060		5,6			475		12.9
F100	1500	10	250	206	441	2"	19.5

TOLERANCES:
 External dimensions: ± 0,05
 Volume: ± 2,5% Height: ± 0,5%

6	SEAL GASKET	1	SILICONE
5	BODY	1	AISI 316
4,1	BOLTS	7	DIN 912 A4-70
4	RETAINING NUT	1	AISI 304
3	FILLING VALVE	1	AISI 316 (1/4" BSP)
2	NOZZLE	1	(+)(PVDF, PTFE or PVC)
1	BELLOWS	1	PTFE
N°	DENOMINATION	QT.	MATERIALS

ATTENTION! ALWAYS MUST BE MOUNTED VERTICALLY (VALVE 3 ON TOP)

Working Temperatures versus Working Pressures.
 For a temperature of 100°C correspond design pressure x 0.82
 150°C x 0.75

WORKING LIMITS TEMPERATURES(°C):

(-5°, +50°C for PVC)
 (-15°, +70°C for PVDF)
 (-20°, +150°C for PTFE)

(+) PVC = PC
 (+) PVDF = PD
 (+) PTFE = TF

MAX. WORKING PRESSURE:
 20 bar-g

** ΔV=C/2 for a single head pump (°C=Head pump volume)
 ΔV=C/6 for a duplex heads pump
 ΔV=C/18 for a three heads pump

THE MAXI TEMPERATURE CAN BE REDUCED DEPENDING ON THE LIQUID IN CONTACT

Those Pulsation Dampeners ought to be filled with gas at a value of 0.80x the pressure to stabilize and that at the working temperature

NOTE: The precharge with gas or air must be done slowly and with our charging tool Ref BV016A1TM

HIDRACAR SA
 08295 S.VTE. CASTELLET
 (BARCELONA) SPAIN
 TEL.34.93.8330252 FAX.34.93.8331950

Customer:	Customer Ref.	Replaced Drg.N°	Drawn:	Approved:
		AFT.AI.BP.IN.PL.DOC (Rev.09)	E.Pansa	M.Caroar6
Title:	PULSATION DAMPER WITH PTFE BELLOWS, SS BODY (All parts in contact with liquid in PTFE and PVDF or PVC)	Drg.No	Rev.	Date
		AFT.AI.BP.IN.PL.DOC	10	Jan-13

ORDER EXAMPLE: F030 AG2 T 1 M/TFG
 Capacity: 2.6 litres
 AD2M20bar
 T= PTFE Bellows
 1" Standard Connection
 Body: AISI 316L
 Nozzle material: PTFE with Graphite filled

Maxi. Pressure = 2 (@Constant Temp.)
 Filling gas Pressure

Net. Minimum sec. to AG-0200 code

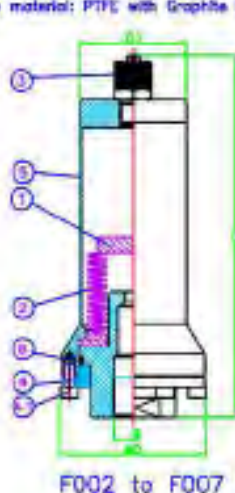

F002 to F007

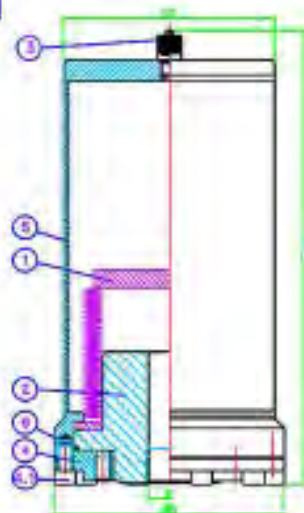

F015 to F100

TOLERANCES:
 External dimensions: + 0.2
 Volume: + 2.5% Weight: + .5%

PULSATION DAMPER MODEL	MAXI. ΔV ADMITED (c.c.)**	VOLUME (litres)	D (mm)	D1 (mm)	L (mm)	R (BSP)	Weight (kg.)
F002	15	0.15	70	53	178	1/2"	1.6
F003	45	0.3	84	64	234	1/2"	2.2
F007	120	0.7	105	84	250		2.7
F015	250	1.4	123	104	276	3/4"	7.1
F030		2.6			306		11.5
F040	600	3.7	170	156	368	1"	12.1
F060		5.6			475		12.9
F100	1500	10	250	206	441	2"	19.5

6	SEAL GASKET	1	SILICONE
5	BODY	1	AISI 316
4.1	BOLTS	7	DIN 912 A4-70
4	RETAINING NUT	1	AISI 304
3	FILLING VALVE	1	AISI 316 (1/4" BSP)
2	NOZZLE	1	PTFE with GRAPHITE filled
1	BELLOWS	1	PTFE
N°	DENOMINATION	QT.	MATERIALS

ATTENTION! ALWAYS MUST BE MOUNTED VERTICALITY (VALVE 3 ON TOP)

Working Temperatures versus Working Pressures

For a temperature of 100°C correspond design pressure x 0.82
 150°C x 0.75

WORKING LIMITS TEMPERATURES(°C):

-20°, +150°C

DESIGN PRESSURE:

20 bar-g

** ΔV=C/2 for a single head pump (°C=Head pump volume)
 ΔV=C/5 for a duplex heads pump
 ΔV=C/18 for a three heads pump

THE MAX TEMPERATURE CAN BE REDUCED DEPENDING ON THE LIQUID IN CONTACT

Those Pulsation Dampeners ought to be filled with gas at a value of 0.80x the pressure to stabilize and that at the working temperature

NOTE: The precharge with gas or air must be done slowly and with our charging tool Ref. BVO16A1TM

HIDRACAR SA
 08295 S.VIE. CASTELLT
 (BARCELONA) SPAIN
 TEL.34.93.8330252 FAX.34.93.8331950

Customer	Customer Ref.	Replaced Drg.N°	Drawn	Approved
		AFT.ALBP.IN.TFG.DOC (Rev.09)	E.Ponsa	M.Carcaró
Title		Drg.No	Rev.	Date
PULSATION DAMPER WITH PTFE BELLOWS, SS BODY (All parts in contact with liquid in PTFE with graphite filled)		AFT.AI.BP.IN.TFG.DOC	10	Jan-15
			Scale	none

IN-LINE 180° & 90° POLIPROPILENE, PVC PULSATION DAMPER

ALSO MADE IN S.S.

PRESSURE DESIGN: 10BAR

THIS DESIGN CAN ACCEPT TWO OR MORE PORTS CONNECTIONS TO CONNECT WITH DIFFERENTS PUMPS

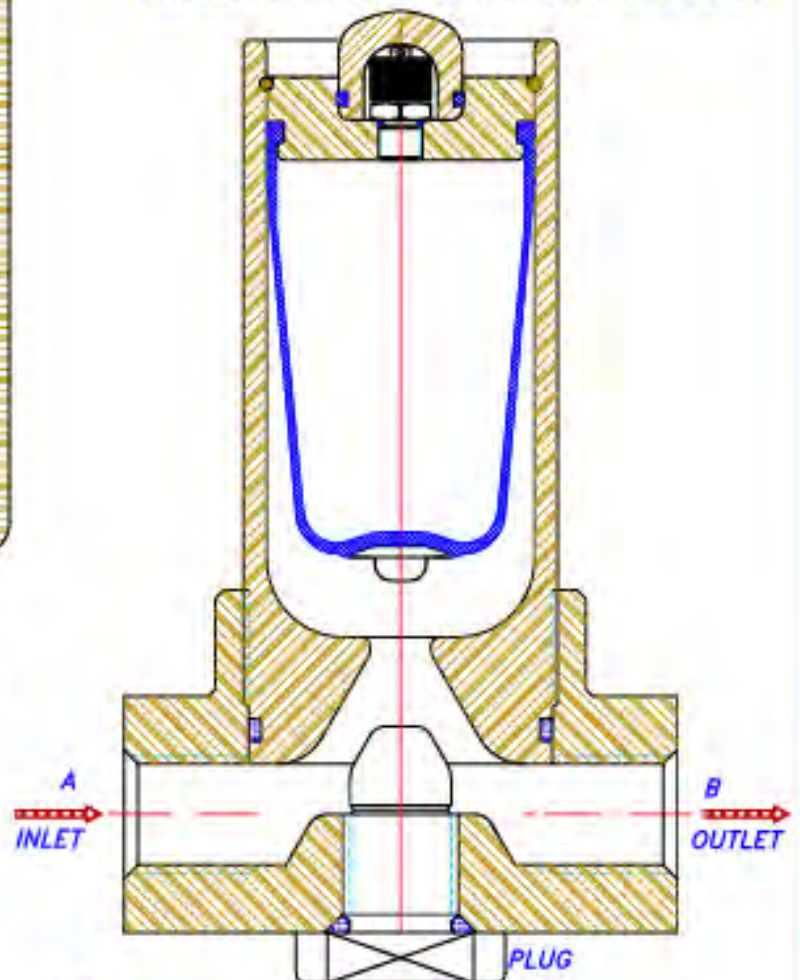
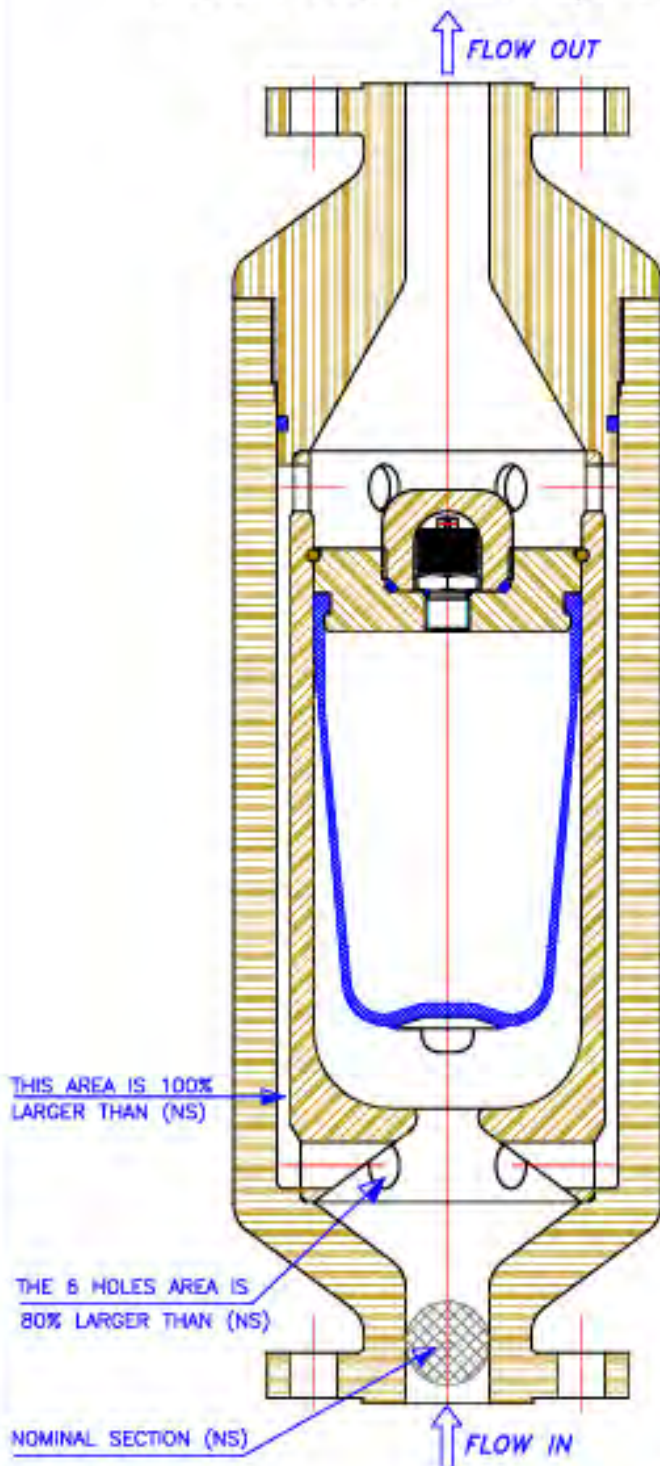

HIDRACAR SA

E-mail: hidracar@hidracar.com

Tel. +34.93.8330252 Fax. +34.93.8331950



HIDRACAR S.A.

STAINLESS STEEL BELLOWS PULSATION DAMPENER

TWO SPECIAL MODELS OF DAMPENER SUPPLIED TO SEVERAL IMPORTANT GERMAN PISTON PUMP MANUFACTURERS

AMORTIGUADOR DE BAJA PRESIÓN CON CAMISA CALEFACTORA

LOW PRESSURE DAMPENER WITH HEATING JACKET

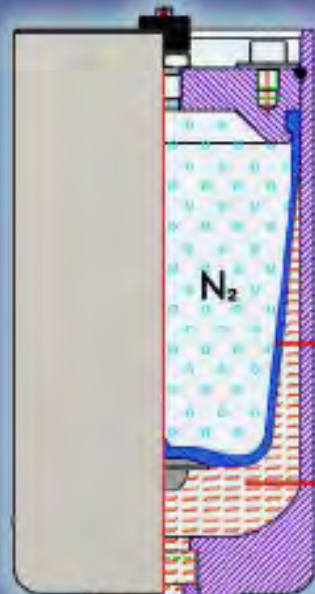

High temperature rubber bladder
Vejiga de caucho para alta temperatura

Thermal oil
Aceite térmico

Heating fluid inlet
Entrada del fluido calefactor

Circuit connection integrated flange
Brida integrada de conexión al circuito

1/4" BSP gas charging adaptor with mechanical seal
Adaptador de carga de 1/4" BSP con estanqueidad mecánica



Heating fluid outlet
Salida del fluido calefactor

AMORTIGUADOR DE PULSACIONES CON FUELLE DE ACERO INOXIDABLE

DOS MODELOS ESPECIALES DE AMORTIGUADORES DE PULSACIONES SUMINISTRADOS A VARIOS IMPORTANTES FABRICANTES ALEMANES DE BOMBAS DE PISTONES

Cooling fins
Aletas de refrigeración

AMORTIGUADOR DE ALTA PRESIÓN PARA FUNCIONAMIENTO A ALTA TEMPERATURA

HIGH PRESSURE DAMPENER FOR WORKING AT HIGH TEMPERATURE

Thermal oil
Aceite térmico

Circuit connection integrated flange
Brida integrada de conexión al circuito





PULSATION DAMPER APPLICATION ON AN AIR VARIABLE PRESSURE DRIVING MEMBRANE PUMP

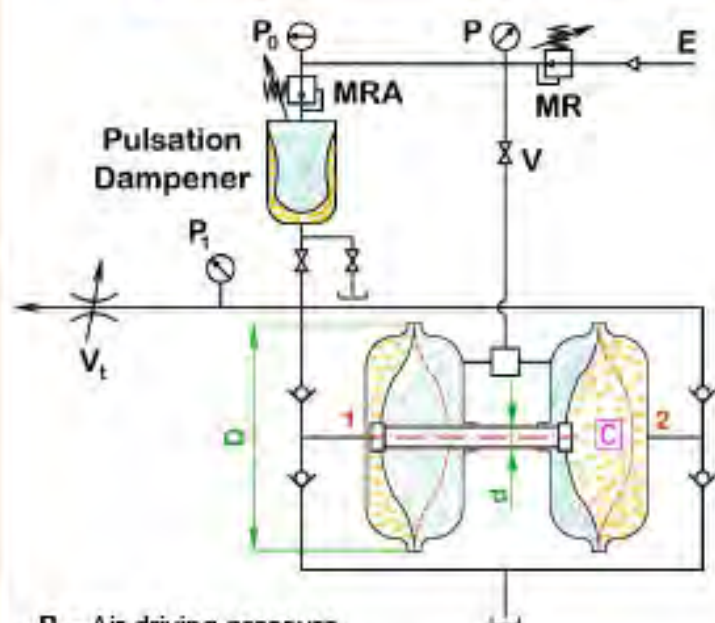

- E – Compressed air from the factory circuit.
- MR – Air pressure reducer.
- MRA – Dampener air precharging pressure reducer.
- V – Isolating valve.
- V_t – Throttle valve to increase the dampener efficiency.

START RUNNING INSTRUCTIONS

- I) Valve "V" closed. Fill the Dampener with air at an estimated pressure. Follow the formulas beside.
- II) Open Valve "V" and adjust the working pressure needed in the liquid circuit.
- III) With the air reducer valve "MRA" adjust the entrance of air into the Dampener until the pressure gage reads the accepted or calculated residual pulsation pressure.

- P – Air driving pressure.
- P₁ – Liquid pumped pressure.
- P₀ – Dampener precharging air pressure.

$$P \times (D - d)^2 = P_1 \times D^2$$

$$P_1 = [P \times (D-d)^2] / D^2 ; (D-d)^2 / D^2 = \text{PUMP CONSTANT} = K$$

$$P_0 \approx 0.75 \times P_1 \longrightarrow P_0 \approx 0.75 \times P \times K$$

NEVER start pumping liquid without air inside the dampener. The Bladder, Membrane or Bellows of the Dampener can be damaged.

NOTE: P₀ ought to be measured with the dampener empty of liquid.

P ₁ versus P ₀ @ Constant Temperature	
P ₁	P ₀
8	6
7	5
6	4.5
5	3.5
4	3
3	2
2	1.5
1	0.7

- ∂V – Liquid going into / out the dampener.
- C – Liquid volume pumped per stroke.
- s – Pump stroke.

Relation between C and ∂V: $\partial V \approx 0.2 \times C$

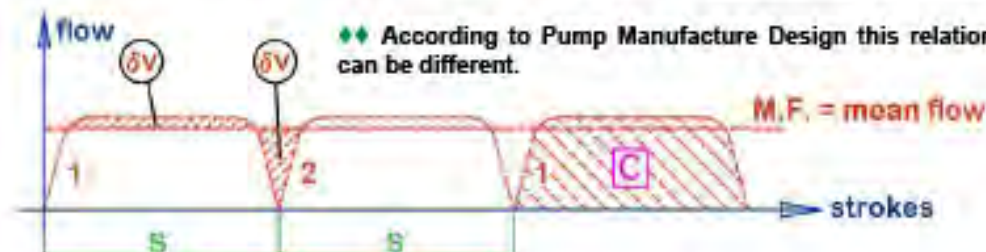

FORMULA TO CALCULATE THE PULSATION DAMPER SIZE (V₀):

$$V_0 \approx 15 \times \partial V$$

♦ FOR A RESIDUAL OSCILLATING PRESSURE OF APPROX. +/- 5% @ CONSTANT TEMPERATURE (To reduce this percentage, increase the Dampener size or, for more accuracy, see our Pulsation Damper Technical and Practical Article)



HIDRACAR S.A.

**ADAPTADORES EN "T"
CON MANÓMETRO**

BT#A-AI



BT#A-PC/PL



BT#A-PC/AI

**"T" ADAPTERS WITH
PRESSURE GAUGE**

Adaptador en "T" de acero inoxidable con carcasa del manómetro en acero inoxidable; o en PVC con carcasas de manómetro disponibles en acero inoxidable o en plástico.

"T" adapters made of stainless steel, with stainless steel pressure gauge casing; or made in PVC with either stainless steel or plastic pressure gauge casing.

La presión de diseño de los adaptadores es de 600 bar para los de acero inoxidable y de 10 bar (y eventualmente de hasta 20 bar) para los de PVC.

The design pressure is 600 bar for the stainless steel adapters and 10 bar (they could possible withstand up to 20 bar) for the PVC ones.

Manómetros disponibles para presiones (#) de: 6, 10, 16, 25, 40, 60, 100, 120, 250, 300, 400 y 600 bar (6, 10 y 16 bar para los de plástico).

Pressure gauges available for pressures (#) of: 6, 10, 16, 25, 40, 60, 100, 120, 250, 300, 400 and 600 bar (6, 10 and 16 bar for plastic adapters).

Conexión del manómetro de latón.
Brass pressure gauge connection.

Disponibles con válvula BSP de 1/4" de acero inoxidable o, si necesita cargar el amortiguador con aire comprimido con un kit de hinchado de neumáticos, con una válvula Vg8 de latón.

Available with stainless steel 1/4" BSP valve or, if the dampener needs to be charged with compressed air using a tyre inflating kit, we can supply our "T" adapter with a brass Vg8 valve.

HIDRACAR S.A.

Pol. Ind. Les Vives - c/ Anaïs Nin, 14
08295 Sant Vicenç de Castellet, Barcelona (SPAIN)
www.hidracar.com • E-mail: hidracar@hidracar.com
Tel.: +34 93 833 02 52 Fax: +34 93 833 19 50

**SISTEMA DE SEGURIDAD
ANTI-EXPLOSIÓN (*) POR
INCENDIO MEDIANTE
FUSIBLE DE TEMPERATURA**

**FIRE OVERPRESSURE
EXPLOSION RISK (*)
TEMPERATURE FUSE
SAFETY SYSTEM**

FST-AI/PP

() Nuestros amortiguadores de pulsaciones están diseñados con un coeficiente de seguridad mínimo de 4:1 para los de acero y de hasta 8:1 para los de plástico.*

() Our pulsation dampeners are designed with a minimum safety coefficient of 4:1 for stainless steel models and up to 8:1 for the plastic ones.*



Permite que el gas del interior del acumulador escape al exterior cuando la temperatura ambiente alcanza los 160° C; y así alivia la presión interior y evita una potencial explosión.

Releases the gas inside the accumulator when the surrounding temperature reaches 160° C; and this way relieves the internal pressure and prevents the risk of explosion.



HIDRACAR S.A.

Pol. Ind. Les Vives – c/ Anais Nin, 14
08295 Sant Vicenç de Castellet, Barcelona (SPAIN)
www.hidracar.com • E-mail: hidracar@hidracar.com
Tel.: +34 93 833 02 52 Fax: +34 93 833 19 50

**HERRAMIENTA DE
EXTRACCIÓN RÁPIDA
DE LA VEJIGA DE LOS
ACUMULADORES**

DRB.A/B



**TOOL FOR QUICK
EXTRACTION OF
THE BLADDER FROM
ACCUMULATORS**

Para toda la gama de nuestros acumuladores de vejiga, excepto el U350.

Suitable for the whole range of our bladder type accumulators, except for U350.

Permite extraer la vejiga sin necesidad de desmontar el acumulador del circuito.

Enables bladder extraction without being necessary to disconnect the accumulator from the circuit.



HIDRACAR S.A.

Pol. Ind. Les Vives - c/ Anaïs Nin, 14
08295 Sant Vicenç de Castellet, Barcelona (SPAIN)
www.hidracar.com • E-mail: hidracar@hidracar.com
Tel.: +34 93 833 02 52 Fax: +34 93 833 19 50



HIDRACAR S.A.

**ADAPTADOR DE ROSCA
PARA VÁLVULA DE
CARGA DE GAS**

67.7(Vg8)

**GAS CHARGING
VALVE THREAD
ADAPTOR**



ADACNEU.5



Adapta la rosca de las válvulas de carga estándar BSP de 1/4" a las de las válvulas Vg8 para poder cargar con aire comprimido, mediante la utilización de un kit de hinchado de neumáticos.

Adapts the thread of 1/4" BSP standard charging valves to the thread of the Vg8 valves so a tyre inflating kit can be used for charging with compressed air.

HIDRACAR S.A.

Pol. Ind. Les Vives - c/ Anaïs Nin, 14
08295 Sant Vicenç de Castellet, Barcelona (SPAIN)
www.hidracar.com • E-mail: hidracar@hidracar.com
Tel.: +34 93 833 02 52 Fax: +34 93 833 19 50

ACCESORIO DE CARGA, PURGADO
Y VERIFICACIÓN DE LA PRESIÓN DE
NUESTROS AMORTIGUADORES DE
PULSACIONES



HIDRACAR S.A.



ACCESORY FOR
CHARGING, PURGING
AND VERIFYING THE
PRESSURE OF OUR PULSATION DAMPENERS

ADAPTADOR "S"
(W21.8x1/14" HEMBRA)
"S" ADAPTER
(W21.8x1/14" FEMALE)



ADAPTADOR "T"
(W24.3x1/14" HEMBRA)
"T" ADAPTER
(W24.3x1/14" FEMALE)



ADAPTADOR "Y"
(5/8" ISO 228)
"Y" ADAPTER



ADAPTADOR "Z"
(W21.8x1/14" MACHO)
"Z" ADAPTER
(W21.8x1/14" MALE)



BV#A1TM

Se suministra con manómetros y adaptador de conexión (S, T, Y o Z) opcionales; así como con manguera de conexión para presiones bajas y medias o para presiones altas (600 y 1.000 bar) según el rango de presiones que se precise.

Supplied with optional pressure gauges and connection hose adapter (S, T, Y or Z); as well as a connection hose for either low and medium pressures or for high pressures (600 and 1,000 bar) as required.

Rango de presiones (#) disponibles:
10, 16, 25, 40, 60, 100, 160, 250, 300, 400, 600 y 1.000 bar.

Range of available pressures (#):
10, 16, 25, 40, 60, 100, 160, 250, 300,
400, 600 and 1,000 bar.



HIDRACAR S.A.

Pol. Ind. Les Vives - c/ Anaïs Nin, 14
08295 Sant Vicenç de Castellet, Barcelona (SPAIN)
www.hidracar.com • E-mail: hidracar@hidracar.com
Tel.: +34 93 833 02 52 Fax: +34 93 833 19 50

ANTI-CORROSION VALVE

Prevents that, when a corrosive liquid is circulating through the circuit, and in case the separator element (bladder, membrane or bellows) of the dampener gets broken, the corrosive liquid could corrode the stainless steel gas charging valve and escape to the exterior.

This anti-corrosion valve is supplied together with the standard gas charging valve.



004-AI + PVDF



VÁLVULA ANTI-CORROSIÓN

Evita que, cuando por el circuito circula un líquido corrosivo, y en caso de rotura del elemento separador (vejiga, membrana o fuelle) del amortiguador, el líquido pueda corroer la válvula de carga de gas de acero inoxidable y fugar al exterior.

Esta válvula anti-corrosión se suministra conjuntamente con la válvula de carga de gas estándar.



HIDRACAR S.A.

Pol. Ind. Les Vives – c/ Anaïs Nin, 14
08295 Sant Vicenç de Castellet, Barcelona (SPAIN)
www.hidracar.com • E-mail: hidracar@hidracar.com
Tel.: +34 93 833 02 52 Fax: +34 93 833 19 50



HIDRACAR S.A.

SOME TECHNICAL AND PRACTICAL RECOMMENDATIONS ABOUT PULSATION DAMPENERS IN CIRCUITS WITH DOSING OR VOLUMETRIC PUMPS

DESCRIPTION OF A PULSATION DAMPENER AND HOW IT WORKS

A pulsation dampener is a vessel with pressurized gas inside, normally Nitrogen. The initial filling or inflating gas pressure inside the dampener must always be lower than the pressure of the circuit where it is installed. The inflating gas pressure of the dampener will be called " P_0 ".

In all pulsation dampeners there is an element to isolate the gas from the circuit liquid; its main function being to avoid gas leaks. This part that separates both fluids is made basically in three kinds of material: Rubber (Nitrile, EPDM, FPM, Butyl, Silicone, etc,...) and thermoplastic material, usually PTFE. When rubber is used the separator element is called bladder and if the PTFE is used the dampener can be either membrane or bellows type according to the form of the separator element; the bellows can also be made in stainless steel. The use of one type of separator or another will generally depend on the particular characteristics of the circuit, such as: The working pressure, temperature and the possible corrosive effect of the circuit liquid over the separator element.

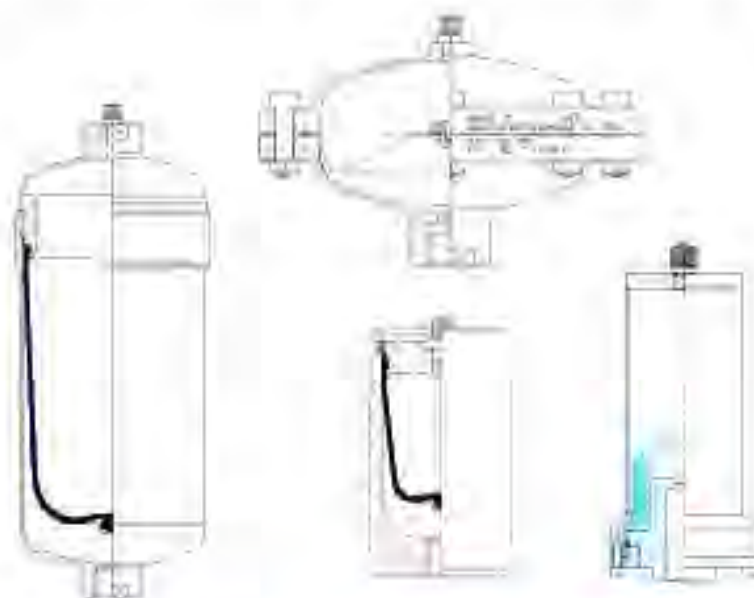

HIDRACAR MOST COMMON DAMPENER DESIGNS

THE FUNCTION of a pulsation dampener is to stabilize the variable and oscillating flow generated in a hydraulic circuit in each cycle by volumetric piston or membrane pumps such as dosing or metering pumps. The main characteristic of these pumps being to deliver a constant volume of liquid in every cycle independently of the circuit resistance or pressure (We will later see the characteristics of this kind of pumps).

When there is a pulsation dampener installed in the circuit, the volume supplied by the pump in every impulse or work cycle it generates is divided in two parts; one goes to the circuit and the other part goes into the pulsation dampener. This volume stored into the dampener is returned right after back into the circuit while the pump is in its suction or chamber filling stage. The amount of liquid going in and out of the dampener in each alternating cycle of the pump will be called " δV ".

When δV gets introduced into the dampener the gas contained inside will be compressed and, therefore, its volume reduced and the pressure increased. The final gas volume (V_2) will be the initial gas volume minus the volume of liquid introduced (δV).

The initial gas volume is, to start, the total volume of the dampener or the size of the dampener. The size of the dampener is an unknown value to be calculated in every case depending on the kind of pump. This volume or size of the dampener will be called " V_0 ".

From all this, we can establish that: $V_2 + \delta V = V_0$

Every dampener has a constant derived from its size and its filling or charging gas pressure:

$$P_0 \times V_0 = \text{constant}$$

In working practice, it is not convenient for the dampeners to get totally emptied of the liquid, previously stored, in each cycle, to avoid the anti-extrusion insert of the separator element from repeatedly hammering against the internal bottom surface of the dampener, what could wear prematurely the bladder or membrane out. A new formula results from it:

$$V_2 + \delta V + v = V_0$$

where " v " is an unused volume of liquid inside the dampener. As a norm this volume is considered to be 10% of the total dampener volume, as long as the temperature remains constant, and, therefore the former formula can be expressed as:

$$V_2 + \delta V + 0.1 V_0 = V_0 \quad \text{and finally as:} \quad V_0 = (V_2 + \delta V) / 0.9$$



The graph above represents the curve (hyperbola) of gas compression inside the accumulator or pulsation dampener.

At the initial gas charge pressure value " P_0 " there is no liquid inside the dampener and the gas fills the whole dampener interior. The curve cuts the ordinate axis in the point where corresponds to a zero value in the abscissa axis. This axis is where the amount or volume of liquid introduced into the dampener in each working cycle is represented.

The pressure " P_1 " is the gas pressure when a volume " v " has been introduced into the dampener; the pressure " P_2 " is the value reached by the gas when the additional volume " δV " is introduced into the dampener.

From this curve we can deduce that for a fixed dampener size if the value " δV " increases then the pressure value " P_2 " will also increase; or the other way around: If we increase the dampener size keeping constant the value " δV " the final pressure gas value " P_2 " will be lower.



Bladder type dampener in its three stages or internal gas volumes

DAMPENER SIZE CALCULATION

The data needed to calculate the dampener size are:

" δV " = Volume of liquid that the dampener must store (in the chapter describing the different types of dosing pumps we will see the relation between " δV " and the cubic capacity of each of the three most common types of pumps).

" P_1 " and " P_2 " are the minimum and maximum pressure values that are accepted in the circuit.

Note: A pulsation dampener does not eliminate 100% of the pressure oscillation produced in the circuits with volumetric or dosing pumps. Its function is to regulate or control the variations of pressure so it remains within previously set limits. This variation, as a +/- percentage of the theoretical pressure " P_t ", is what determines, together with the value of " δV ", the size of the pulsation dampener.

" P_t " is the pressure needed at the pump outlet, in order to overcome all the resistances that will arise, to circulate the liquid all the way to the end of the hydraulic circuit.

Let's see an example: If the theoretical or work pressure in a circuit is " P_t " and the residual pulsation admitted is +/- 5% of this pressure, values P_1 and P_2 will be:

$$P_1 = P_t - (5/100) \times P_t \quad \text{and} \quad P_2 = P_t + (5/100) \times P_t$$

With all this known data: δV , P_1 and P_2 , we can already calculate the dampener size " V_0 ".

The ideal gas law in isothermal conditions (Boyle's law) (later on we will clarify this equation for this application) gives us the following equality:

$$P_0 \times V_0 = P_1 \times V_1 = P_2 \times V_2 = \text{Constant.} \quad (1)$$

If: $V_1 = V_0 - v$ and $v = 0.1 \times V_0$

we have: $V_1 = 0.9 \times V_0$ (2)

and also: $V_2 = V_1 - \delta V$ (3)

Finally, from (1) and (2) we obtain: $P_0 = 0.9 \times P_1$ (4)

and then from (1), (2), (3) and (4) we will get:

$$P_0 \times V_0 = P_2 \times V_2; \quad \underline{0.9 P_1 \times V_0} = P_2 \times (V_1 - \delta V) = \underline{P_2 (0.9 V_0 - \delta V)}$$

From the underlined ends of the equalities we obtain the final formula:

$$V_0 = \frac{P_2 \times \delta V}{0.9 (P_2 - P_1)} \quad (5)$$

This is the simplified theoretical formula to calculate the pulsation dampener volume as a function of δV , P_1 and P_2 .

As we have already said, it is accepted as a norm that the charging gas pressure, " P_0 " = 0,9 P_1 . This difference between P_0 and P_1 prevents the complete emptying of liquid from the dampener in each work cycle. Having this extra quantity of liquid " v " (stored in the dampener in between P_0 and P_1) can also be used to compensate, in some instances, the potential changes in the gas pressure produced by variations in the exterior temperature that would modify the calculated theoretical " δV " and in that case it could not be completely introduced into or discharged out of the dampener.

The former equality (1) $P_0 \times V_0 = P_1 \times V_1 = \dots = P_n \times V_n$ does not comply in practice because, when a volume of gas is compressed (in a short time), the temperature rises, what increases the pressure, and when a gas expands its pressure drops an extra value because the temperature is reduced (refrigerator effect). This effect happens with the majority of gases, included Nitrogen and air, which are the more commonly used for charging the dampeners (atmospheric air can be used for pressures below 10 bar, providing there is no risk of chemical reaction between the Oxygen in the air and the pumped liquid).

The formula (1) gets, thus, transformed into:

$$(P_0 \times V_0)^\gamma = (P_1 \times V_1)^\gamma = \dots = (P_n \times V_n)^\gamma$$

where γ = specific heat ratio of the gas at constant pressure and volume, respectively. For the majority of gases, $\gamma = 1.41$ This constant is also theoretical. In the practice the value that can be used is $\gamma = 1.25$ But in order not to complicate the formula of dampener size calculation we will use a new constant (0.8) that will give the same result.

$$V_0 = \frac{P_2 \times \delta V}{0.8 \times 0.9 \times (P_2 - P_1)} \quad (6)$$

This formula can be used in practice for nearly all industrial applications. It will be very unlikely for the volumes given by this formula to fit any standard dampener volume size from a manufacturer. Except for very exigent applications we can recommend to use the manufacturer's standard closer lower size, favouring cost efficiency.

Note: We have not considered a possible temperature variation of the fluid or environment. This would change the charging gas pressure value at 20° (take note that for each 10°C variation in temperature the gas pressure will change approximately by 3%).

DIFFERENT TYPES OF DOSING PUMPS TO WHICH DAMPENERS CAN BE MOUNTED

We will consider pumps with one, two or three pistons and crankshaft movement being these the most extended and used and also those in bigger need for a dampener (for air operated, peristaltic, etc... pumps please consult *HIDRACAR S.A.* technical department).

The graphics below correspond to these three types of piston pumps and represent the instantaneous flow during a complete crankshaft revolution. We have taken the same piston dimensions (diameter x stroke) for all three types of pumps.

T = time employed by the piston and crank during one revolution (ex: $\phi = 360^\circ$, $\omega = 1500$ rpm)
 V = capacity of the piston head (ex: 508 c.c. for the three-pump system)
 \bar{Q} = theoretically the amount of liquid going in and out of the dampener in each cycle
 $\bar{Q}_1, \bar{Q}_2, \bar{Q}_3$ = instantaneous flow $\bar{Q}_m, \bar{Q}_c, \bar{Q}_s$ = mean flow

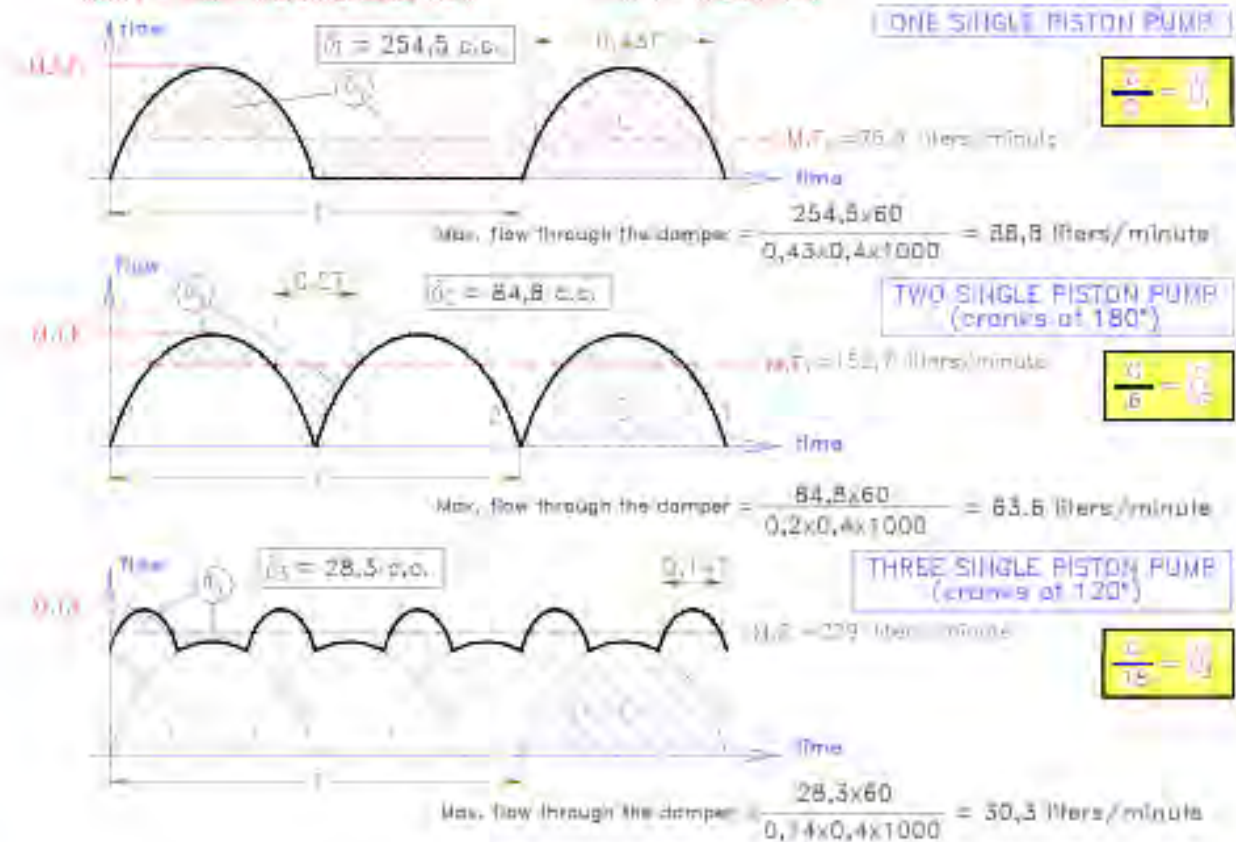

These curves let us see how a pulsation dampener works: If we pay attention to the first curve, representing a single piston pump, we can observe that for this type of pump the use of a dampener is almost essential, as otherwise during half revolution of the pump crankshaft no liquid flow is delivered. Also if the pump does not include a dampener, the diameter of the pipe must be calculated for the maximum instantaneous flow, which takes place when the piston speed is also at its maximum, in the middle of piston stroke (the flow curve is a sinusoid).

With a dampener installed, from the point where it is mounted onwards the maximum flow supplied to the circuit now practically becomes the mean flow of the pump, what makes possible to reduce the pipe diameter **by 40%!!** And this because the maximum instantaneous flow of the pump is 2.8 times superior to its medium flow. In some cases this reduction of pipe diameter alone will compensate for the cost of the dampener; on top of the main advantage of stabilizing the circuit's pressure, with all of its obvious associated improvements (pressure in an hydraulic circuit is, basically, a function of the flow, and therefore if it varies, the pressure varies as well).

Carrying on with the first curve we can see that the task of the dampener is to store all the excess volume, over the mean flow line, of the total piston head during the piston impulse stroke; and then to return this volume " \bar{Q}_1 " back into the circuit during the piston suction stroke. So then, in this type of pump the volume stored by the dampener is half of the pump head or capacity per revolution.

As we analyse all three curves we can see that, as the number of pistons in a pump increase, the mean flow gets closer and closer to the maximum flow and the liquid volume " \bar{Q}_1 " stored by the dampener gets correspondingly reduced, and therefore the required size of the dampener also gets reduced (this is totally valid in a case like this, where all the pistons in the three pumps have the same diameter, stroke and number of revolutions per minute).

To summarise: The more pistons a pump has, the lower the dampener size is required and also the smaller both the pipe section and the port connection between the dampener and the circuit can be (always assuming the pumps provide the same flow independently of the number of cylinders).

The relation between " δV " and the pump capacity per revolution " C " is

$$\delta v = C / 2 \quad \text{For a single-action one piston pump}$$

$$\delta v = C / 6 \quad \text{For a single-action two piston pump}$$

$$\delta v = C / 18 \quad \text{For a three piston pump}$$

(Practical values for the calculation of the dampener size).

We know that when a gas is compressed its pressure increases, and decreases if it expands its volume. When a dampener is installed by the outlet of a piston pump the pressure of the liquid in the circuit will fluctuate according to the values of the volume of gas inside the dampener. This pressure variability, a \pm percentage of pressure P_t will be defined by the technical designer of the circuit or by final customer requirements.

The following graphs will help to better understand the above exposed:

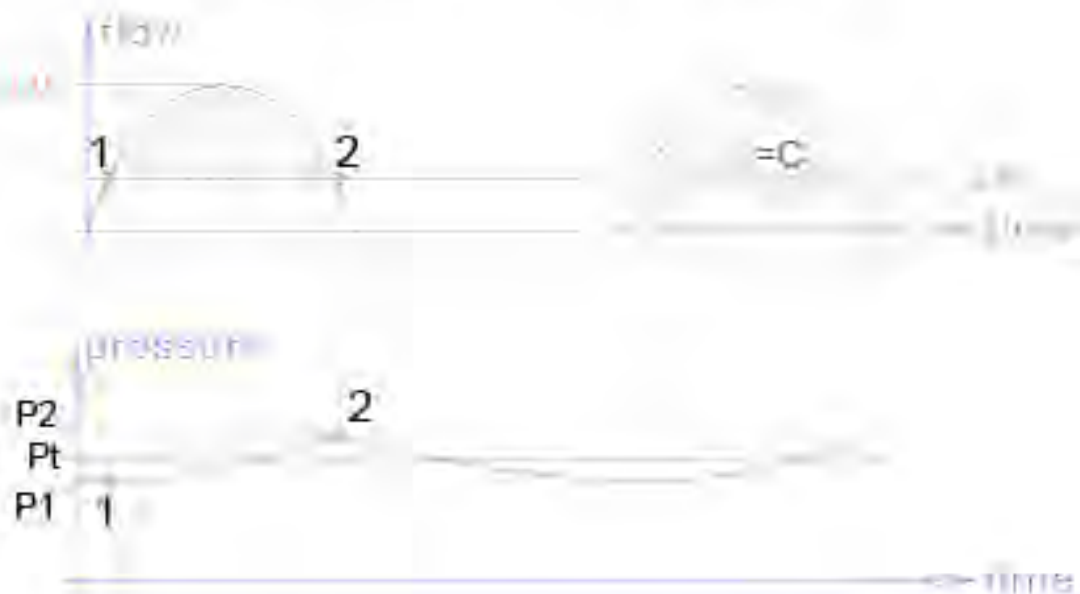

The lower curve from the above graphs shows the pressure fluctuation of a circuit with a dampener installed. This curve relates to the pump flow variation curve. As we have seen before, a dampener stores the volume of liquid above the pump mean flow. For this reason, the minimum value of the pressure curve (point 1) must coincide with the first crossing point of the instantaneous flow curve with the line of the mean flow and the maximum value of the pressure curve (point 2) must coincide with the second crossing point between them, the moment when all " δV " has been introduced inside the dampener.

Let's remember that the area comprised between the instantaneous flow curve and the abscissa axis (time) represents a volume which in the case of a single piston pump is equal to the pump capacity per stroke or revolution. (flow \times time = volume).

Let's see now the meaning of P_1 , P_t and P_2 in the pressure / time curve:

In all hydraulic circuits the pressure at the pump outlet port is a function of the flow, pipe length and diameter, viscosity of the pumped liquid, internal pipe surface roughness, geometric height, etc... If the flow keeps constant over time, the pressure needed to pump the liquid will also be constant as long as there is no change either in flow resistance (for instance, due to sedimentation on filters, etc...) We call this constant working pressure or " P_t ".

When a circuit must be designed, one ought to take the mean flow and the opposing resistances to calculate the pressure " P_1 ".

We see that from one side the dampener stabilizes the flow and for that also the pressure, but in fact the pressure goes from " P_1 " to " P_2 ". The reason behind this is that the dampener has to stabilize the flow and for that it needs to compress and expand a gas volume, and these pressure variations in +/- percentage of P_1 are those that regulate the values accepted in the circuit.

We have already seen that this pressure fluctuation can be reduced down to very small values by increasing the volume of the dampener. " P_1 " and " P_2 " are the percentage values of " P_1 ", already commented which are pressure variations that the final customer must determine; though we do not recommend them to be less than +/- 2%, as the environmental temperature conditions will very probably modify the theoretical calculation.

MOUNTING SUGGESTIONS FOR MAXIMUM DAMPENER EFFICIENCY

As we have seen so far, taking into consideration the flow curves for the three types of pump, the single piston pump is the pump with the higher "maximum instantaneous flow / mean flow" ratio and also the one for which the liquid getting into and out of the dampener in each cycle, " δV ", has a higher value; always considering both same piston diameter and pump stroke or displacement for all three pumps. Therefore in the next example we will refer to this type of pump.

We can say that for 99% of industrial applications, if the recommendations that we detail below are followed, the dampener's efficiency will be guaranteed.

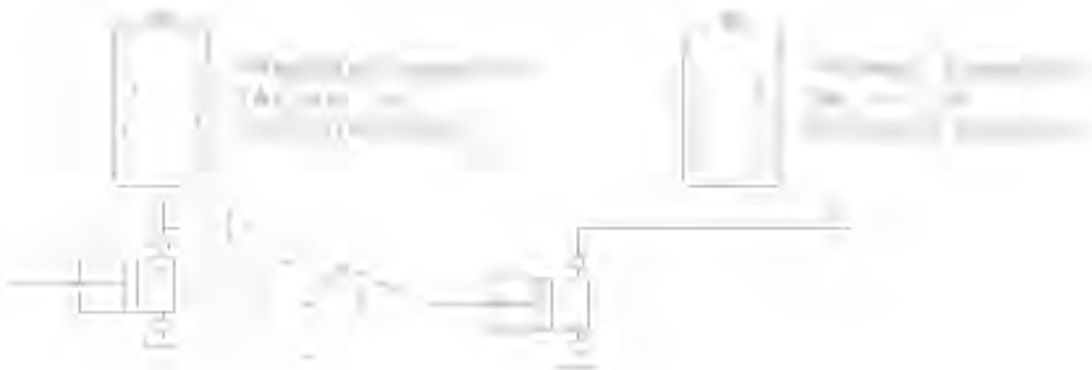

- 1.- The dampener must be mounted with its axis aligned with the axis of the pump outlet.
- 2.- The distance between the pump outlet port and the dampener port connection must be as short as possible.
- 3.- The pipe section between the pump and the dampener connection must be calculated for the pump maximum instantaneous flow.
- 4.- The remaining pipe section of the circuit must be calculated for the mean flow.

In the next drawing we will see more clearly all the concepts we have exposed so far.

- Ω : Pipe section for the mean flow.
- Ω : Small length of pipe section for the maximum instantaneous flow.
- Q : Maximum instantaneous flow.
- μ : Mean flow.
- Δ : Distance between pump and dampener, as short as possible.



To show the difference between in-line and derivation mounting to a circuit, and the higher efficiency of the former, we will remember some fluid mechanics principles:

The flow of a liquid inside a pipe follow different speed lines: In the centre of the pipe the velocity is higher, while it becomes nearly zero close to the pipe inner wall (see next drawing). If the mean liquid velocity increases, the difference between the dynamic pressure (the pressure measured in the liquid movement direction) and the static pressure (the pressure measured perpendicular to the liquid movement direction) also increases. The drawing below reflects this: in-line mounting corresponds to the dynamic pressure reading; the derivation mounting to the static pressure. *(Note: We assume the fluid circulates in a laminar regime)*



If the dampener is not only mounted in derivation but also far from the pump outlet the efficiency of the dampener will be reduced a great deal. And if on top of this it is installed in a pipe section with a smaller diameter than the main circuit pipe, then the effect of the dampener will be negligible.

WARNING: It is of utmost importance that the pulsation dampener admission duct is not narrower than its connection port. Any reduction in the diameter, when attached to low pressure circuits, will greatly reduce the performance and efficiency of the dampener.

SOLUTION TO PROBLEMS OF PARTICULAR PULSATION DAMPENERS APPLICATIONS

I) CIRCUITS THAT HAVE TO BE CLEANED PERIODICALLY AT THE END OF EACH PROCESS

All pulsation dampeners, whatever its type - though certainly some more than others - have, because of its own design, hard to reach internal corners which are difficult to clean or to totally eliminate residues of the pumped product from.

The most reliable and efficient solution to this problem, in accordance with our longer than 35 years experience, is to use a quick dismantling system to extract the bladder out of the dampener, and then clean separately both the bladder and the interior of the dampener body. In the case of applications where the charging gas pressure is lower than 10 bar and compressed air can be used to fill the dampener, it is the most effective solution. *HIDRACAR S.A.* has designed a quick bladder dismantling system that makes unnecessary any additional tool.

If for whatever the reason dismantling the bladder is out of the question, we recommend the pressure of the cleaning liquid to be higher than the pumping pressure of the process product; that way the internal corners between the bladder or membrane and the inner surface of the dampener will expand, allowing a better access to the cleaning fluid.

II) CIRCUITS WITH A VARIABLE WORKING PRESSURE

The problem arisen by the application of dampeners to this type of circuits has different solutions. But also in this case the experience has shown us that the best solution is, as always, the simplest one, or at least the solution requiring a lower implementation and maintenance cost and no extra energy.

Let's consider the following example: A circuit that must work at an initial pressure of 20 bar and a final pressure of 200 bar, with a $\delta V = 15$ c.c. and a maximum residual pulsation accepted at 200 bar of +/- 5% (*). The pump is simple effect single piston type and its capacity per stroke is: 30 c.c. To simplify calculations we will consider that the gas volume variation takes place at a constant temperature (isothermal curve complying with $P \times V = \text{Constant}$).

(*) : At 20 bar the residual pulsation will be much lower because, as shown below, the dampener size is calculated for the maximum circuit pressure and therefore when the circuit is working at the minimum pressure - here, 20 bar - the gas inside the dampener will expand and consequently the residual pulsation will decrease from the +/- 5% initially admitted).

Since: $P_2 \times V_2 = P_0 \times V_0$ $P_0 = 0.9 \times 20 = 18 \text{ bar}$ $P_2 = 200 + 5\% = 210 \text{ bar}$

$$P_2 / P_0 = V_0 / V_2 = 210 / 18 = 11.66 \quad (6)$$

We will calculate the volume of a hypothetical dampener for the maximum pressure of 210 bar.

$$V_0 = (210 \times 15) / [0.8 \times 0.9 \times (210 - 190)] = 218.75 \text{ c.c.} \quad (\text{from formula (6) in page 4})$$

This volume is equivalent to " V_2 " from the equality (7), and consequently:

$$(210 / 18) = (V_0 / 218.75) = 11.66$$

and $V_0 = 218.75 \times 11.66 = 2,550.62 \text{ c.c.}$

This is in theory the total dampener volume necessary for this application; nevertheless, the ratio, V_0 / V_2 ratio cannot be higher than 4 (In bladder type dampeners. The value will be different in other design types of dampener. Please, consult *HIDRACAR S.A.* technical department for further details on the particular) in order not to wrinkle the bladder excessively, what could tear it prematurely. In our example, we have a ratio V_0 / V_2 of $2,550.62 / 218.75 = 11.65$, nearly 3 times higher than the value of 4 that we have just recommended.

To avoid exceeding this ratio of 4:1, a certain amount of liquid must be introduced inside the bladder together with the gas (usually the same liquid of the circuit or any other unable to react with either the bladder material or with the circuit liquid). Again, in our example this volume of liquid which has to be introduced into the bladder, " V_L " (see figure), is calculated:

$$(2,550.62 + V_L) / 218.75 + V_L \leq 4 \quad \text{and operating:} \quad V_L = 558.54 \text{ c.c.}$$

The total dampener volume needed will be: $2,550.62 + 558.54 = 3,109.16 \text{ c.c.}$

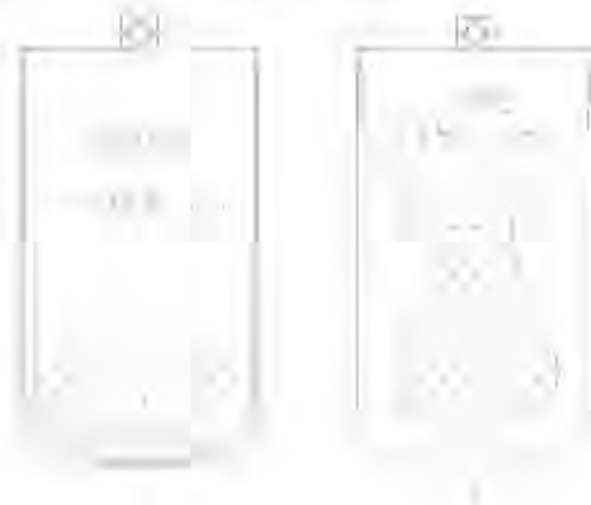

WHEN TO INSTALL A PULSATION DAMPENER AT THE SUCTION INLET OF PISTON TYPE OR SIMILAR VOLUMETRIC OR DOSING PUMPS

As already said, volumetric pumps are used to dose with precision a constant volume of liquid. And therefore, the pump must get completely filled in every suction stroke piston displacement cycle.

When in the liquid inlet port of the pump the pressure can easily overcome the resistance of the suction valve spring that all pumps have (we can allow the pressure at the inlet port to exceed the resistance of the valve spring beyond 3 bar), and the section of the suction pipe is about twice the discharge section of the pump, it won't be necessary to install a pulsation dampener at the suction inlet.

If the static pressure of the liquid at the pump inlet is low (below the already mentioned 3 bar) the suction pipe is long enough, longer than 3 to 5 metres from the suction liquid supply tank to the pump inlet, and also the liquid has a low vapour tension at the working temperature then a phenomenon called "cavitation" could take place.

When this anomaly takes place, the pump could suction a mix of liquid and its vapour that, on being compressed during the pump discharge cycle, causes, because of the pump impulsion pressure, the condensation of the vapour and, in consequence, produces a reduction in volume. This effect, which can be detected by a soft explosion-like sound, reduces considerably the life of the pump, which also stops providing the required dosing.

In order to eliminate this problem it is necessary to prevent the pressure at the pump inlet port to be lower or close to the vapour tension of the liquid. And a condition for this, other than having enough pressure, is to avoid the suction pipe liquid column to be subjected to accelerations and decelerations caused by the operation of the pump.

It is precisely, and exclusively to avoid these fluctuations in the liquid column (accelerations and decelerations) at the suction pipe that a pulsation dampener is needed at the suction of volumetric or dosing pumps.

The pulsation dampener installed at the suction of the pump fulfills the same task as the one installed at the discharge: To keep the velocity of the liquid as constant as possible; and therefore, its pressure. If the low pressure of the liquid at the suction does not experiment any substantial drop, the possibility of reaching the vapour tension of the liquid will decrease and the main cause for the appearance of "cavitation" will be eliminated.

The pulsation dampener will not be able to avoid the "cavitation" phenomenon if all its determinants are present; and therefore it is convenient, when a risk exists, to install in order to prevent it an auxiliary centrifugal or similar pump, or else, to raise the the liquid supply tank, or pressurize it, and this way increase the pressure at the inlet port of the dosing pump.

If all these recommendations can't be applied, there is the resort of installing the pulsation dampener to try to avoid the appearance of the "cavitation" effect. For this it is specially recommended that:

The size or volume of the dampener installed at the suction must be approximately twice as much as for the one installed at the discharge.

The size of the connection port of the dampener must be at least identical to the diameter of the suction pipe.

The dampener must be installed as close as possible to to the pump liquid inlet port, with the least possible pipe length in between.

The gas charging or inflating pressure must be below atmospheric.

For further detail explaining about the above exposed, please, contact [HIDRACAR S.A.](#) technical department.

We have written this paper in the modest hope of helping any people interested in these devices to understand the applications of the hydro-pneumatic accumulators used as pulsation dampeners. If it results useful to anyone, we will feel satisfied and rewarded for the time and effort spent in the making.

5th rev., July 2012

Manuel Carcaré Gimeno
Technical Director & *HIDRACAR S.A.* founder



HIDRACAR S.A.

Pol. Ind. LES VIVES, s/n - Apdo. 35
08295 St. Vicenç de Castellet
Barcelona (Spain)

Tel. +34 93 833 02 52 • Fax +34 93 833 19 50
e-mail: hidracar@hidracar.com

www.hidracar.com



TÜV Rheinland
CERT
ISO 9001